

## FRU (Field Replaceable Unit) List

---

This chapter gives you the FRU (Field Replaceable Unit) list in global configurations of Aspire 3650/Travelmate 2450. Please refer to this chapter whenever ordering for parts to repair or for RMA (Return Merchandise Authorization).

Please note that WHEN ORDERING FRU PARTS, you should check the most up-to-date information available on your regional web or channel. For whatever reasons a part number change is made, it will not be noted on the printed Service Guide. For ACER AUTHORIZED SERVICE PROVIDERS, your Acer office may have a DIFFERENT part number code from those given in the FRU list of this printed Service Guide. You MUST use the local FRU list provided by your regional Acer office to order FRU parts for repair and service of customer machines.

**NOTE:** To scrap or to return the defective parts, you should follow the local government ordinance or regulations on how to dispose it properly, or follow the rules set by your regional Acer office on how to return it.



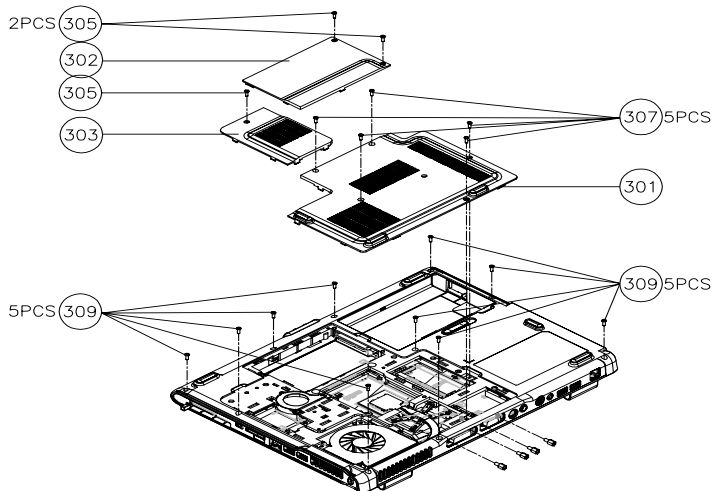
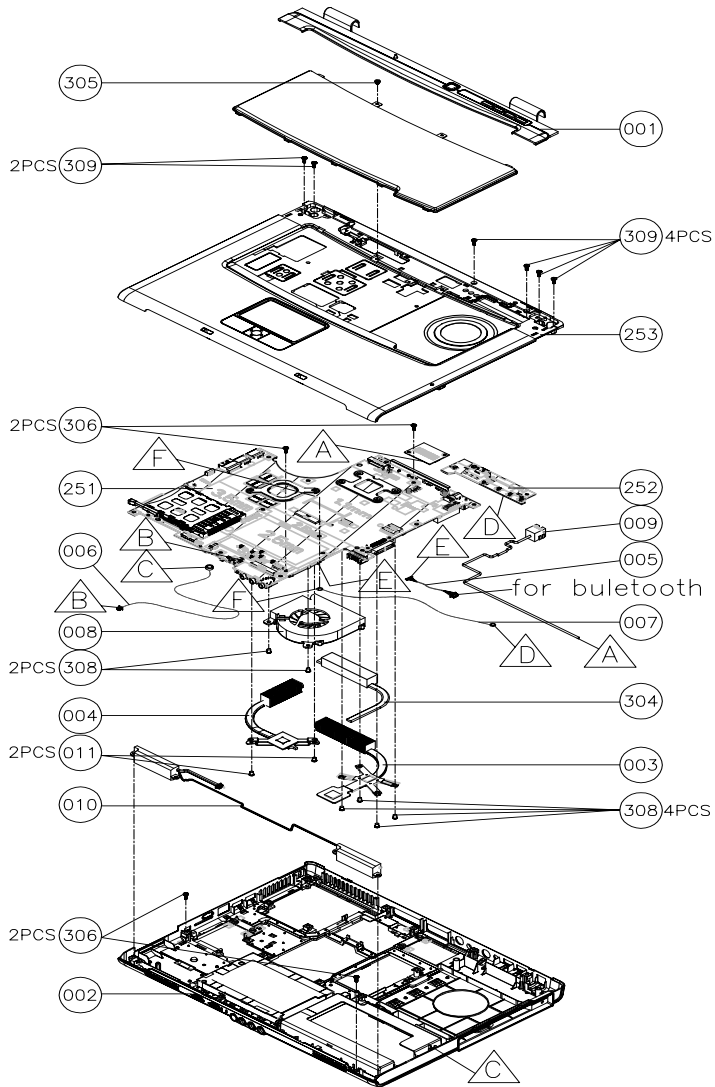

# Exploded Diagram



## Aspire 5650 FRU List

Image	No.	Part Name and Description	Acer PN
<b>ADAPTER</b>			
	N/A	ADAPTER 90W 3PIN DELTA ADP-90SB BBAC	AP.09001.003
	N/A	ADAPTER 90W 3PIN LITEON PA-1900-04LR	AP.09003.006
	N/A	ADAPTER 90W 3PIN LISHIN SLS0202C19A20LF	AP.09006.004
<b>BATTERY</b>			
		BATTERY LI-ION 8 CELLS 4800MAH SONY	BT.00804.012
		BATTERY LI-ION 8 CELLS 4800MAH SANYO	BT.00803.015
<b>BOARDS</b>			
		MODEM BOARD FOXCONN T60M845.02	54.TAVV5.001
		BLUETOOTH MODULE FOXCONN T60H928.00 (BRM2045)	54.TAVV5.002
		MINI PCI WIRELESS BOARD 802.11 A/B/G MOW1 INTEL MM872612	KI.GLN01.001
		MINI PCI WIRELESS BOARD 802.11 A/B/G MOW2 INTEL MM872659	KI.GLN01.002
		MINI PCI WIRELESS BOARD 802.11 A/B/G ROW INTEL MM874511	KI.GLN01.003
		MINI PCI WIRELESS BOARD 802.11 A/B/G JPN	KI.GLN01.004
		MINI PCI WIRELESS BOARD 802.11 B/G INTEL MM874652	KI.GLN01.005
		MEDIA BOARD W/FFC AS	55.A93V5.001
		SIM BOARD W/FFC	55.TAVV5.002



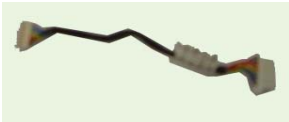

## Aspire 5650 FRU List

Image	No.	Part Name and Description	Acer PN
		EXPRESS CARD	55.TAVV5.003
		SWITCH BOARD W/O TV AS/TM	55.TAVV5.001
		SWITCH BOARD W/TV AS	55.ABVV5.001
		TV TUNER - M103 ANALOG	55.A61V5.007
		TV TUNER - M104 ANALOG	55.A61V5.004
		TV TUNER - M115 ANALOG + DTV	55.A61V5.005
CABLE			
		FFC CABLE - T/P TO MB	50.TAVV5.001
		RJ-11 CABLE	50.TAVV5.002
		BLUETOOTH CABLE	50.TAVV5.003
		TV RF CABLE - SWITCH BOARD TO TV TURNER	50.ABVV5.001
		7 PIN MINI-DIN S-VIDEO TO 4 CABLE	50.A61V5.011
		PAL TO NTSC CONNECTOR	20.A61V5.001
		CABLE - 3.5 PHONE JACK TO PAL TV	50.A61V5.013
		PAL-NTSC DVB-T ANT	50.A61V5.014
		POWER CORD US 3 PIN	27.TAVV5.001
		POWER CORD EU 3 PIN	27.TAVV5.002
		POWER CORD AUS 3 PIN	27.TAVV5.003
		POWER CORD UK 3 PIN	27.TAVV5.004
		POWER CORD CHINA 3 PIN	27.TAVV5.005
		POWER CORD SWISS 3 PIN	27.TAVV5.006
		POWER CORD ITALIAN 3 PIN	27.TAVV5.007
		POWER CORD DENMARK 3 PIN	27.TAVV5.008
		POWER CORD JP 3 PIN	27.TAVV5.009

## Aspire 5650 FRU List

Image	No.	Part Name and Description	Acer PN
		POWER CORD SOUTH AFRICA 3 PIN	27.TAVV5.010
		POWER CORD KOERA 3 PIN	27.TAVV5.011
		POWER CORD ISRAEL 3 PIN	27.TAVV5.012
		POWER CORD INDIA 3 PIN	27.TAVV5.013
		POWER CORD TWN 3 PIN	27.TAVV5.014
CASE/COVER/BRAKETS ASSEMBLY			
		MIDDLE COVER AS	42.A93V5.001
		UPPER CASE AS W/O TV	60.A93V5.001
		UPPER CASE AS W/TV	60.ABVV5.001
		UPPER CASE AS LGA W/O TV	60.A93V5.002
		UPPER CASE AS LGA W/TV	60.ABVV5.002
		LOWER CASE W/CARD 1394 FIR DVI W/O TV	60.ABWW5.001
		LOWER CASE W/ ALL	60.ABVV5.003
		LOWER CASE LGA W/CARD 1394 FIR DVI W/O TV	60.ABWW5.002
		LOWER CASE LGA W/ ALL	60.ABVV5.004
		THERMAL DOOR	42.TAVV5.002
		MINI DOOR	42.TAVV5.003

## Aspire 5650 FRU List

Image	No.	Part Name and Description	Acer PN
		T/P BRACKET	33.TAVV5.001
COMMUNICATION MODULE			
		WIRELESS ANTENNA 15 IN.	50.TAVV5.011
		WIRELESS ANTENNA 15.4 IN.	50.TAVV5.012
CPU/PROCESSOR			
		CPU INTEL YONAH FSB-667 DUAL CORE 2.16G 2M	KC.26001.DTP
		CPU INTEL YONAH FSB-667 DUAL CORE 2.0G 2M	KC.25001.DTP
		CPU INTEL YONAH FSB-667 DUAL CORE 1.83G 2M	KC.24001.DTP
		CPU INTEL YONAH FSB-667 DUAL CORE 1.66G 2M	KC.23001.DTP
COMBO DRIVE			
		DVD SUPER MULTI MODULE PANASONIC UJ-845-CQBA SLOT IN	6M.ABVV5.001
		DVD SUPER MULTI DRIVE PANASONIC UJ-845-CQBA SLOT IN	KU.00807.029
		DVD SUPER MULTI BEZEL PANASONIC SLOT IN	42.ABVV5.001
		OPTICAL BRACKET	33.TAVV5.002
HDD/HARD DISK DRIVE			
		HDD SATA 100G 5400RPM HGST MORAGA+B HTS541010G9SA00	KH.10007.005
		HDD SATA 100G 5400RPM SEAGATE MERCURY2 ST9100824AS	KH.10001.005
		HDD SATA 100G 5400RPM SEAGATE T9120824A LF N2.2 FW:3.06	KH.10001.008
		HDD DOOR AS W/RUBBER	42.A93V5.002

## Aspire 5650 FRU List

Image	No.	Part Name and Description	Acer PN
		HDD BRACKET	33.TAVV5.003
KEYBOARD			
		KEYBOARD CHINESE AS	KB.ASP07.001
		KEYBOARD THAILAND AS	KB.ASP07.003
		KEYBOARD HEBREW AS	KB.ASP07.023
		KEYBOARD ARABIAN AS	KB.ASP07.018
		KEYBOARD US INTERNATIONAL AS	KB.ASP07.002
		KEYBOARD RUSSIA AS	KB.ASP07.014
		KEYBOARD GREEK AS	KB.ASP07.021
		KEYBOARD CZECH REPUBLIC AS	KB.ASP07.012
		KEYBOARD UK AS	KB.ASP07.005
		KEYBOARD SWEDEN AS	KB.ASP07.015
		KEYBOARD FRENCH AS	KB.ASP07.007
		KEYBOARD PORTUGUESE AS	KB.ASP07.011
		KEYBOARD CROATIA AS	KB.ASP07.140
		KEYBOARD SLOVENIA AS	KB.ASP07.139
		KEYBOARD BRAZIL PORTUGES AS	KB.ASP07.019
		KEYBOARD SWISS/G AS	KB.ASP07.008
		KEYBOARD DENMARK AS	KB.ASP07.017
		KEYBOARD ITALIAN AS	KB.ASP07.006
		KEYBOARD BELGIUM AS	KB.ASP07.009
		KEYBOARD GERMAN AS	KB.ASP07.004
		KEYBOARD CANADA FRANCH AS	KB.ASP07.020
		KEYBOARD NORWAY AS	KB.ASP07.016
		KEYBOARD HUNGARY AS	KB.ASP07.013
		KEYBOARD SPANISH AS	KB.ASP07.010
		KEYBOARD TURKEY AS	KB.ASP07.022
LCD			
		ASSY LCD MODULE 15 IN. XGA AS FOR WIRELESS	6M.A93V7.001

## Aspire 5650 FRU List



Image	No.	Part Name and Description	Acer PN
		LCD 15 IN. XGA AUO (B150XG02. V4) LF	LK.15005.010
		LCD 15 IN. XGA QDI QD15XL06 V.3 LF	LK.15009.008
		LCD 15 IN. XGA LG LP154X08-TLA2 LF	LK.15008.019
		LCD 15 IN. XGA CMO N150X3-L09 Rev. C1 LF	LK.1500D.013
		LCD 15 IN. XGA SAMSUNG LTN150XB-L03-V LF	LK.15006.008
		INVERTER BOARD - 15 IN.	19.TAVV5.001
		LCD PANEL 15 IN. WITH LOGO W/ ANTENNA AS	60.A93V5.011
		LCD BEZEL - 15 IN.	60.TAVV5.004
		LCD BRACKET SET ( R&L ) - 15	6K.TAVV5.001
		LCD WIRESET - 15 IN.	50.TAVV5.004
		LCD RUBBER	47.TAVV5.001
		LATCH RUBBER	47.TAVV5.006
		LCD SCREW PAD	47.TAVV5.002





## Aspire 5650 FRU List

Image	No.	Part Name and Description	Acer PN
		ASSY LCD MODULE 15.4 WXGA AS FOR WIRELESS	6M.A93V7.001
		LCD 15.4 WXGA LG LP154W01-TLA1 LF	LK.15408.013
		LCD 15.4 WXGA SAMSUNG LTN154X3-L01-100 LF	LK.15406.014
		LCD 15.4 WXGA AUO B154EW01 V.8 LF	LK.15405.005
		LCD 15.4 WXGA CMO N154I1-L0B Rev. C1 LF	LK.1540D.005
		LCD 15.4 WXGA QDI QD15TL07-01 LF	LK.15409.008
		INVERTER BOARD - 15.4 IN.	19.TAVV5.002
		LCD PANEL 15.4 IN. WITH LOGO W/ 15.4 ANTENNA AS	60.A93V5.012
		LCD BEZEL - 15.4 TEXTURE	60.TAVV5.006
		LCD BRACKET SET ( R&L ) - 15.4	6K.TAVV5.003
		LCD WIRESET - 15.4	50.TAVV5.005
		LCD RUBBER	47.TAVV5.001
		LATCH RUBBER	47.TAVV5.006
		LCD SCREW PAD	47.TAVV5.002
		ASSY LCD MODULE 15.4 WXGA GLARE AS FOR WIRELESS	6M.A93V7.002
		LCD 15.4 WXGA GLARE LG LP154W01-TLA2	LK.15408.014
		LCD 15.4 WXGA GLARE SAMSUNG LTN154X3-L01-H00	LK.15406.015
		LCD 15.4 WXGA GLARE AUO B154EW01 V.9	LK.15405.006
		LCD 15.4 WXGA GLARE CMO N154I1-L0C Rev. C1	LK.1540D.006
		LCD 15.4 WXGA GLARE QDI QD15TL07-02	LK.15409.009
		INVERTER BOARD - 15.4 IN.	19.TAVV5.002
		LCD PANEL 15.4 IN. WITH LOGO W/ 15.4 ANTENNA AS	60.A93V5.012
		LCD BEZEL - 15.4 TEXTURE	60.TAVV5.006
		LCD BRACKET SET ( R&L ) - 15.4	6K.TAVV5.003
		LCD WIRESET - 15.4	50.TAVV5.005
		LCD RUBBER	47.TAVV5.001
		LATCH RUBBER	47.TAVV5.006
		LCD SCREW PAD	47.TAVV5.002
MAINBOARD			

## Aspire 5650 FRU List

Image	No.	Part Name and Description	Acer PN
		MAINBOARD 945PM DISCRETE SATA G73M GLAN 128M W/CARD DVI W/O CPU MEMORY	MB.ABD02.001
		MAINBOARD 945PM DISCRETE SATA G73M GLAN 256M W/CARD DVI W/O CPU MEMORY	MB.ABV02.001
PCMCIA SLOT/PC CARD SLOT			
		PCMCIA SOCKET	22.TAVV5.001
MEMORY			
		MEMORY 512MB DDR II 533 NANYA NT512T64UHA1FN-37B	KN.51203.023
		MEMORY 512MB DDR II 533 INFINEON HYS64T64020HDL-3.7-A	KN.51202.021
		MEMORY 512MB DDR II 533 MICRON MT8HTF6464HDY-53EB3	KN.51204.019
		MEMORY 512MB DDR II 533 SAMSUNG M470T6554CZ3-CD500	KN.5120B.015
		MEMORY 512MB DDR II 533 HYNIX HYMP564S64P6-C4	KN.5120G.005
FAN			
		FAN ASSY - UMA	23.TAVV5.001
HEATSINK			
		THERMAL MODULE - CPU	60.TAVV5.009
		VGA HEATSINK	60.TAVV5.010
MISCELLANEOUS			
		RUBBER FOOT - LARGE	47.TAVV5.003
		RUBBER FOOT - MIDDLE	47.TAVV5.004
		RUBBER FOOT - SMALL	47.TAVV5.005
		THERMAL DOOR RUBBER	47.TAVV5.007
		NAME PLATE - AS5650	40.A94V5.001
		T/P BRACKET UP FOIL	47.TAVV5.008
POINTING DEVICE			

## Aspire 5650 FRU List

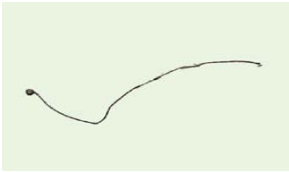
Image	No.	Part Name and Description	Acer PN
		TOUCHPAD W/SPONGE	56.TAVV5.001
SPEAKER			
		SPEAKER SET (R&L)	23.TAVV5.002
		MIC	23.TAVV5.003
ACCESSORY			
		REMOTE CONTROLLER - FORWARD 48-KEY	LZ.A6102.001
		REMOTE CONTROLLER - FORMASA 14-KEY	LZ.A2902.001
SCREW LIST			
		SCREW M2.5*3(NL)	86.TAVV5.001
		SCREW M2.5*6(NL)	86.TAVV5.002
		SCREW M2.5*10(NL)	86.TAVV5.003
		SCREW M2.5*15(NL)	86.TAVV5.004
		SCREW M2*2.2	86.TAVV5.005
		SCREW M2*3(NL)	86.TAVV5.006
		SCREW M2*4	86.TAVV5.007
		SCREW M3*4(NL)	86.TAVV5.008
		SCREW D-SUB 4#X40* 1/5-NI (NL)	86.TAVV5.009

