

# eMachines E627 Service Guide

Service guide files and updates are available on the ACER/CSD web; for more information, please refer to <http://csd.acer.com.tw>

PRINTED IN TAIWAN

---

# Revision History

Please refer to the table below for the updates made on eMachines E627 service guides.

Date	Chapter	Updates

---

## Copyright

Copyright © 2009 by Acer Incorporated. All rights reserved. No part of this publication may be reproduced, transmitted, transcribed, stored in a retrieval system, or translated into any language or computer language, in any form or by any means, electronic, mechanical, magnetic, optical, chemical, manual or otherwise, without the prior written permission of Acer Incorporated.

## Disclaimer

The information in this guide is subject to change without notice.

Acer Incorporated makes no representations or warranties, either expressed or implied, with respect to the contents hereof and specifically disclaims any warranties of merchantability or fitness for any particular purpose. Any Acer Incorporated software described in this manual is sold or licensed "as is". Should the programs prove defective following their purchase, the buyer (and not Acer Incorporated, its distributor, or its dealer) assumes the entire cost of all necessary servicing, repair, and any incidental or consequential damages resulting from any defect in the software.

Acer is a registered trademark of Acer Corporation.

Intel is a registered trademark of Intel Corporation.

Pentium and Pentium II/III are trademarks of Intel Corporation.

Other brand and product names are trademarks and/or registered trademarks of their respective holders.

---

## Conventions

The following conventions are used in this manual:

<b>SCREEN MESSAGES</b>	Denotes actual messages that appear on screen.
<b>NOTE</b>	Gives bits and pieces of additional information related to the current topic.
<b>WARNING</b>	Alerts you to any damage that might result from doing or not doing specific actions.
<b>CAUTION</b>	Gives precautionary measures to avoid possible hardware or software problems.
<b>IMPORTANT</b>	Reminds you to do specific actions relevant to the accomplishment of procedures.



---

## Preface

Before using this information and the product it supports, please read the following general information.

1. This Service Guide provides you with all technical information relating to the BASIC CONFIGURATION decided for Acer's "global" product offering. To better fit local market requirements and enhance product competitiveness, your regional office MAY have decided to extend the functionality of a machine (e.g. add-on card, modem, or extra memory capability). These LOCALIZED FEATURES will NOT be covered in this generic service guide. In such cases, please contact your regional offices or the responsible personnel/channel to provide you with further technical details.
2. Please note WHEN ORDERING FRU PARTS, that you should check the most up-to-date information available on your regional web or channel. If, for whatever reason, a part number change is made, it will not be noted in the printed Service Guide. For ACER-AUTHORIZED SERVICE PROVIDERS, your Acer office may have a DIFFERENT part number code to those given in the FRU list of this printed Service Guide. You MUST use the list provided by your regional Acer office to order FRU parts for repair and service of customer machines.



<b>System Specifications</b>	<b>1</b>
Features	1
System Block Diagram	4
Your Acer Notebook tour	5
Front View	5
Closed Front View	6
Rear View	7
Left View	7
Right View	8
Bottom View	8
Indicators	10
TouchPad Basics	11
Using the Keyboard	12
Lock Keys and embedded numeric keypad	12
Windows Keys	13
Hot Keys	14
Special Key	15
Using the System Utilities	16
Acer GridVista (dual-display compatible)	16
Hardware Specifications and Configurations	17
 <b>System Utilities</b>	 <b>25</b>
BIOS Setup Utility	25
Navigating the BIOS Utility	25
eMachines E627 BIOS	26
Information	26
Main	27
Security	28
Boot	31
Exit	32
BIOS Flash Utilities	33
DOS Flash Utility	34
WinFlash Utility	35
Remove HDD/BIOS Password Utilities	36
 <b>Machine Disassembly and Replacement</b>	 <b>41</b>
Disassembly Requirements	41
Pre-disassembly Instructions	42
Disassembly Process	42
External Module Disassembly Process	43
External Modules Disassembly Flowchart	43
Removing the Battery Pack	44
Removing the SD Dummy Card	45
Removing the Lower Covers	46
Removing the Optical Drive Module	47
Removing the DIMM Modules	49
Removing the WLAN Module	50
Removing the Hard Disk Drive Module	52
Main Unit Disassembly Process	54
Main Unit Disassembly Flowchart	54
Removing the Switch Cover	55
Removing the Keyboard	56
Removing the LCD Module	57
Removing the Upper Cover	61

# Table of Contents

Removing the Power Board . . . . .	65
Removing the Left Speaker Module . . . . .	66
Removing the Right Speaker Module . . . . .	68
Removing the TouchPad Bracket . . . . .	70
Removing the Mainboard . . . . .	72
Removing the RTC Battery . . . . .	73
Removing the Thermal Module . . . . .	74
Removing the CPU Fan . . . . .	76
Removing the CPU . . . . .	78
LCD Module Disassembly Process . . . . .	79
LCD Module Disassembly Flowchart . . . . .	79
Removing the LCD Bezel . . . . .	80
Removing the Camera Module . . . . .	81
Removing the LCD Panel . . . . .	82
Removing the LCD Brackets and FPC Cable . . . . .	84
Removing the Antennas . . . . .	86
LCD Module Reassembly Procedure . . . . .	89
Replacing the Antennas . . . . .	89
Replacing the LCD Panel . . . . .	92
Replacing the Camera Module . . . . .	94
Replacing the LCD Bezel . . . . .	95
Main Module Reassembly Procedure . . . . .	97
Replacing the CPU . . . . .	97
Replacing the CPU Fan . . . . .	98
Replacing the Thermal Module . . . . .	98
Replacing the Mainboard . . . . .	99
Replacing the TouchPad Bracket . . . . .	100
Replacing the Right Speaker Module . . . . .	102
Replacing the Left Speaker Module . . . . .	103
Replacing the Power Board . . . . .	104
Replacing the Upper Cover . . . . .	104
Replacing the LCD Module . . . . .	108
Replacing the Keyboard . . . . .	113
Replacing the Switch Cover . . . . .	114
Replacing the Hard Disk Drive Module . . . . .	114
Replacing the WLAN Module . . . . .	116
Replacing the DIMM Modules . . . . .	116
Replacing the ODD Module . . . . .	117
Replacing the Lower Covers . . . . .	117
Replacing the SD Dummy Card . . . . .	118
Replacing the Battery . . . . .	119

## Troubleshooting

121

Common Problems . . . . .	121
Power On Issue . . . . .	122
No Display Issue . . . . .	123
Random Loss of BIOS Settings . . . . .	124
LCD Failure . . . . .	125
Built-In Keyboard Failure . . . . .	125
TouchPad Failure . . . . .	126
Internal Speaker Failure . . . . .	126
HDD Not Operating Correctly . . . . .	128
ODD Failure . . . . .	129
Wireless Function Failure . . . . .	132
Thermal Unit Failure . . . . .	132

# Table of Contents

External Mouse Failure . . . . .	133
Other Failures . . . . .	133
Intermittent Problems . . . . .	134
Undetermined Problems . . . . .	134
Post Codes . . . . .	135
<b>Jumper and Connector Locations</b>	<b>139</b>
Top View . . . . .	139
Bottom View . . . . .	140
Power Board . . . . .	141
Clearing Password Check and BIOS Recovery . . . . .	142
Clearing Password Check . . . . .	142
Clear CMOS Jumper . . . . .	142
BIOS Recovery by Crisis Disk . . . . .	143
<b>FRU (Field Replaceable Unit) List</b>	<b>145</b>
eMachines E627 Exploded Diagrams . . . . .	146
Main Assembly . . . . .	146
Base Assembly . . . . .	148
Rear Assembly . . . . .	149
eMachines E627 FRU List . . . . .	150
<b>Model Definition and Configuration</b>	<b>160</b>
<b>Test Compatible Components</b>	<b>173</b>
Microsoft® Windows® Vista Environment Test . . . . .	174
<b>Online Support Information</b>	<b>177</b>

# ***Table of Contents***

# System Specifications

---

## Features

Below is a brief summary of the computer's many features:

### Operating System

- Genuine Windows® Vista™

### Platform

- AMD Athlon™ 64 X2 dual-core processor
- AMD Athlon™ 64 single-core processor
- AMD M780G Chipset

### System Memory

- Low-latency, high-bandwidth
- 128-bit DDR2 SDRAM controller operating at up to 333 MHz
- On-board memory with up to 2 unbuffered SO-DIMM slots supporting DDR II 667/800.
- Adjustable Maximum 128MB UMA VGA memory shared from North Bridge
- Maximum memory: 2GB per slot; 4GB total
- On-board cache up to 1MB

### Display

- 15.6" WXGA, HD 720p, 1366x768

### Graphics

- ATI Radeon™ HD 3200 Graphics

### Storage subsystem

- 2.5" hard disk drive
- Multi-in-1 card-reader

### Optical Drive

- DVD-Super Multi double-layer drive

### Audio

- Realtek ALC272X-GR for High Definition Audio Codec with Dolby Digital Live
- Internal speakers x2 (2W)
- Mic-in jack

- 
- Headphone/Line out jack

## Dimensions and Weight

- 372.3mm x 246.5mm x 26.8mm/40.6mm with ID
- Weight < than 3100g (15.6" LCD/6-cell battery/super-multi ODD)

## Communication

- Wireless
  - 802.11b/g/n WLAN/WiMax
  - Mini PCIE Wireless LAN module with with mini card slot
  - Dual-Band built-in Antenna for Wireless LAN
- LAN
  - Atheros AR8132L for 10/100 LAN
  - PCI-E 10/100M LAN
  - WOL (AC mode S5) support
- Modem
  - External USB 2.0 modem
  - Support Wake on Ring (S3)

## Privacy control

- BIOS user, supervisor, HDD passwords
- Kensington lock slot

## Power subsystem

- 65W
- Universal jack for adapter
- Battery: 6-cell AS2009A

## Special keys and controls

- 99-/100-/103-key keyboard
- Supports Application keys for Windows XP/Linux version
- Support for Home key and Application keys for Windows XP/Linux version
- Multi-language support

## I/O interface

- VGA port, 15 pins
- DC-IN port for adapter
- RJ-45 Ethernet port for LAN
- 2 USB port
- Headphone out / Line-out
- Microphone-in
- Multi-in-1 card reader (SD™, MMC, MS, MS PRO, xD)



- 
- Kensington Lock (7.5mm)

## Environment

- Temperature:
  - Operating: 5 °C to 35 °C
  - Non-operating: -20 °C to 65 °C
- Humidity (non-condensing):
  - Operating: 20% to 80%
  - Non-operating: 20% to 80%

# System Block Diagram

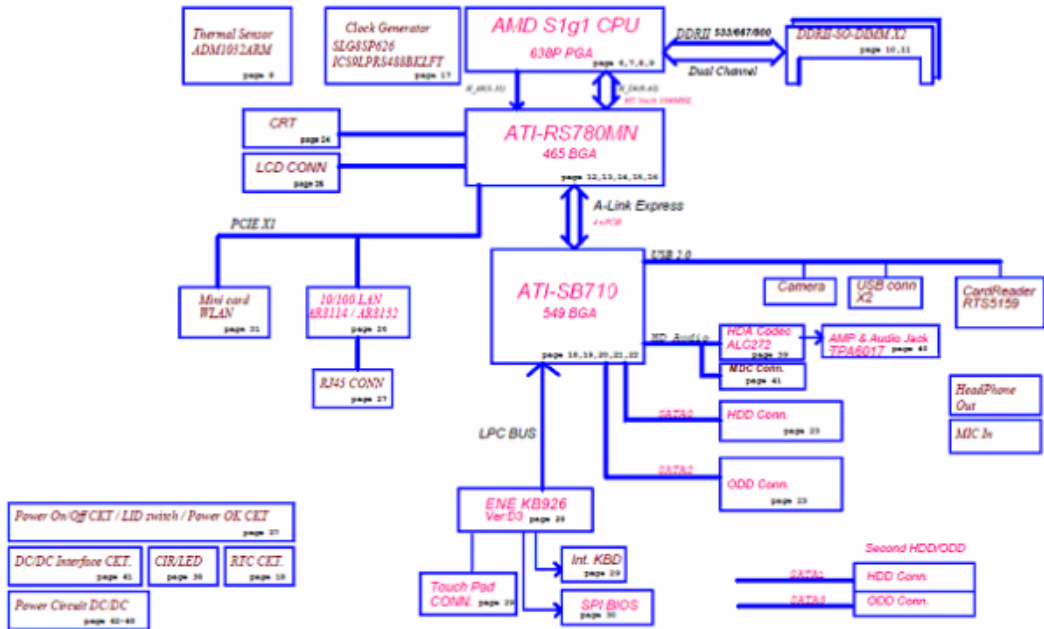



# Your Acer Notebook tour

After knowing your computer features, let us show you around your new computer.

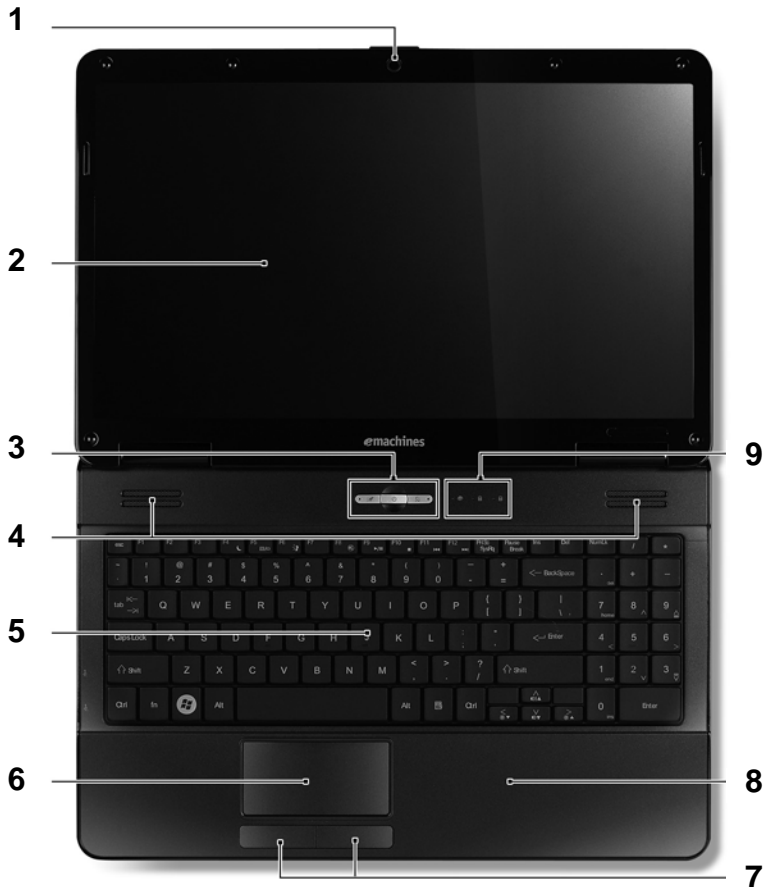
## Front View





No.	Icon	Item	Description
1		Integrated webcam	Web camera for video communication (for selected models).
2		Display screen	Also called Liquid-Crystal Display (LCD), displays computer output.
3		Touchpad toggle	Turns the internal touchpad on and off.
		Power button	Turns the computer on and off.
		Wireless LAN communication button/indicator	Enables/disables the wireless LAN function. Indicates the status of wireless LAN communication.
4		Speaker	Left and right speakers deliver stereo audio output.
5		Keyboard	For entering data into your computer.
6		TouchPad	Touch-sensitive pointing device which functions like a computer mouse.

No.	Icon	Item	Description
7		Click buttons (left and right)	The left and right buttons function like the left and right mouse buttons.
8		Palmrest	Comfortable support area for your hands when you use the computer.
9		HDD	Indicates when the hard disk drive is active.
		Num Lock	Lights up when Num Lock is activated.
		Caps Lock	Lights up when Caps Lock is activated.

## Closed Front View



No.	Icon	Item	Description
1		Power <sup>1</sup>	Indicates the computer's power status.
		Battery <sup>1</sup>	Indicates the computer's battery status. <b>1. Charging:</b> The light shows amber when the battery is charging. <b>2. Fully charged:</b> The light shows green when in AC mode.
2		Multi-in-1 card reader	Accepts Secure Digital (SD), MultiMediaCard (MMC), Memory Stick (MS), Memory Stick PRO (MS PRO), xD-Picture Card (xD). <b>NOTE:</b> Push to remove/install the card. Only one card can operate at any given time.

**NOTE:** <sup>1</sup> The front panel indicators are visible even when the computer cover is closed

## Rear View



No.	Icon	Item	Description
1		Ventilation slots	Enable the computer to stay cool, even after prolonged use.

## Left View

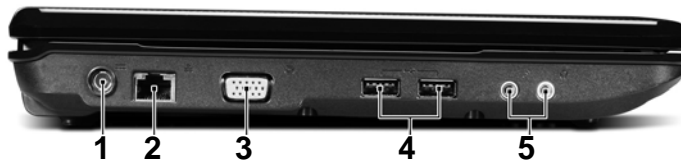

No.	Icon	Item	Description
1		DC-in jack	Connects to an AC adapter
2		Ethernet (RJ-45) port	Connects to an Ethernet 10/100-based network.
2		External display (VGA) port	Connects to a display device (e.g. external monitor, LCD projector).
4		USB 2.0 ports	Connect to USB 2.0 devices (e.g. USB mouse, USB camera).
5		Microphone-in jack	Accepts input from external microphones.
		Headphones/speaker/line-out jack	Connects to audio line-out devices (e.g. speakers, headphones).

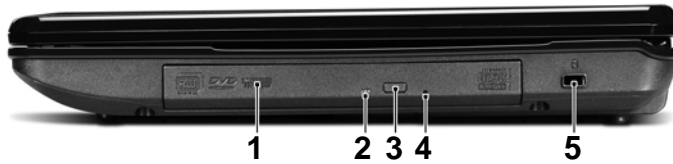

## Right View

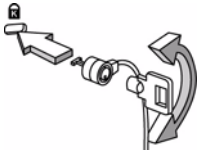

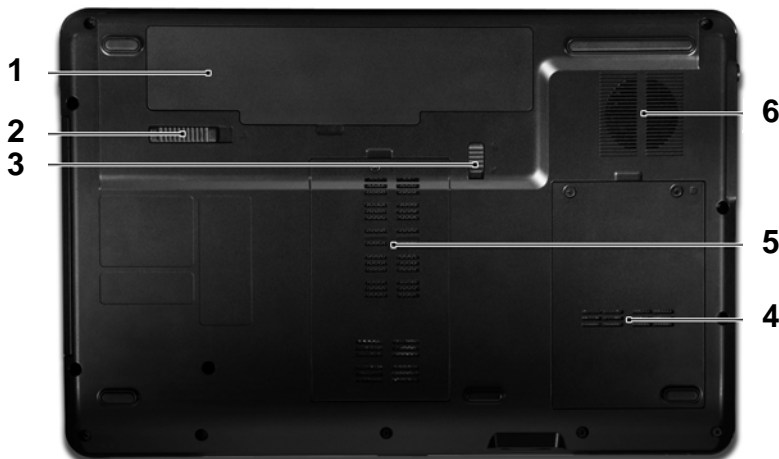

No.	Item	Description	
1		Optical drive	Internal optical drive; accepts CDs or DVDs.
2		Optical disk access indicator	Lights up when the optical drive is active.
3		Optical drive eject button	Ejects the optical disk from the drive.
4		Emergency eject hole	Ejects the optical drive tray when the computer is turned off. <b>Note:</b> Insert a paper clip into the emergency eject hole to eject the optical drive tray when the computer is off.
5		Kensington lock slot 	Connects to a Kensington-compatible computer security lock. <b>Note:</b> Wrap the computer security lock cable around an immovable object such as a table or handle of a locked drawer. Insert the lock into the notch and turn the key to secure the lock. Some keyless models are also available.

## Bottom View



No.	Icon	Item	Description
1		Battery bay	Houses the computer's battery pack.
2		Battery release latch	Releases the battery for removal.





---

No.	Icon	Item	Description
3		Battery lock	Locks the battery in position.
4		Hard disk bay	Houses the computer's hard disk (secured with screws).
5		Memory compartment	Houses the computer's main memory.
5		Ventilation slots and cooling fan	Enable the computer to stay cool, even after prolonged use. <b>Note:</b> Do not cover or obstruct the fan opening.

---

## Indicators

The computer has several easy-to-read status indicators. The front panel indicators are visible even when the computer cover is closed.

Icon	Function	Description
	Power	Indicates the computer's power status.
	Battery	Indicates the computer's battery status.
	HDD	Indicates when the hard disk drive is active.
	Num Lock	Lights up when Num Lock is activated.
	Caps Lock	Lights up when Caps Lock is activated.

**NOTE:** 1. **Charging:** The light shows amber when the battery is charging. 2. **Fully charged:** The light shows green when in AC mode.



---

# TouchPad Basics

The following items show you how to use the TouchPad:

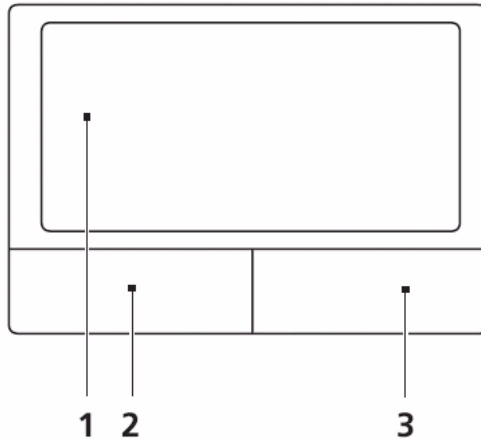

- Move your finger across the TouchPad (1) to move the cursor.
- Press the left (2) and right (3) buttons located beneath the TouchPad to perform selection and execution functions. These two buttons are similar to the left and right buttons on a mouse. Tapping on the TouchPad is the same as clicking the left button.

Function	Left Button (2)	Right Button (3)	Main TouchPad (1)
Execute	Quickly click twice.		Tap twice (at the same speed as double-clicking a mouse button).
Select	Click once.		Tap once.
Drag	Click and hold, then use finger on the TouchPad to drag the cursor.		Tap twice (at the same speed as double-clicking a mouse button); rest your finger on the TouchPad on the second tap and drag the cursor.
Access context menu		Click once.	

**NOTE:** When using the TouchPad, keep it - and your fingers - dry and clean. The TouchPad is sensitive to finger movement; hence, the lighter the touch, the better the response. Tapping too hard will not increase the TouchPad's responsiveness.

# Using the Keyboard

The keyboard has full-sized keys and an embedded numeric keypad, separate cursor, lock, Windows, function and special keys.

## Lock Keys and embedded numeric keypad

The keyboard has three lock keys which you can toggle on and off.





















Lock key	Description
Caps Lock	When Caps Lock is on, all alphabetic characters typed are in uppercase.
Num Lock <Fn> + <F11>	When Num Lock is on, the embedded keypad is in numeric mode. The keys function as a calculator (complete with the arithmetic operators +, -, *, and /). Use this mode when you need to do a lot of numeric data entry. A better solution would be to connect an external keypad.
Scroll Lock <Fn> + <F12>	When Scroll Lock is on, the screen moves one line up or down when you press the up or down arrow keys respectively. Scroll Lock does not work with some applications.

The embedded numeric keypad functions like a desktop numeric keypad. It is indicated by small characters located on the upper right corner of the keycaps. To simplify the keyboard legend, cursor-control key symbols are not printed on the keys.

Desired access	Num Lock on	Num Lock off
Number keys on embedded keypad	Type numbers in a normal manner.	
Cursor-control keys on embedded keypad	Hold <Shift> while using cursor-control keys.	Hold <Fn> while using cursor-control keys.
Main keyboard keys	Hold <Fn> while typing letters on embedded keypad.	Type the letters in a normal manner.

# Windows Keys

The keyboard has two keys that perform Windows-specific functions.

Key	Description
 Windows key	<p>Pressed alone, this key has the same effect as clicking on the Windows Start button; it launches the Start menu. It can also be used with other keys to provide a variety of functions:</p> <ul style="list-style-type: none"> <li>&lt;  &gt;: Open or close the Start menu</li> <li>&lt;  &gt; + &lt;D&gt;: Display the desktop</li> <li>&lt;  &gt; + &lt;E&gt;: Open Windows Explore</li> <li>&lt;  &gt; + &lt;F&gt;: Search for a file or folder</li> <li>&lt;  &gt; + &lt;G&gt;: Cycle through Sidebar gadgets</li> <li>&lt;  &gt; + &lt;L&gt;: Lock your computer (if you are connected to a network domain), or switch users (if you're not connected to a network domain)</li> <li>&lt;  &gt; + &lt;M&gt;: Minimizes all windows</li> <li>&lt;  &gt; + &lt;R&gt;: Open the Run dialog box</li> <li>&lt;  &gt; + &lt;T&gt;: Cycle through programs on the taskbar</li> <li>&lt;  &gt; + &lt;U&gt;: Open Ease of Access Center</li> <li>&lt;  &gt; + &lt;X&gt;: Open Windows Mobility Center</li> <li>&lt;  &gt; + &lt;BREAK&gt;: Display the System Properties dialog box</li> <li>&lt;  &gt; + &lt;SHIFT+M&gt;: Restore minimized windows to the desktop</li> <li>&lt;  &gt; + &lt;TAB&gt;: Cycle through programs on the taskbar by using Windows Flip 3-D</li> <li>&lt;  &gt; + &lt;SPACEBAR&gt;: Bring all gadgets to the front and select Windows Sidebar</li> <li>&lt;CTRL&gt; + &lt;  &gt; + &lt;F&gt;: Search for computers (if you are on a network)</li> <li>&lt;CTRL&gt; + &lt;  &gt; + &lt;TAB&gt;: Use the arrow keys to cycle through programs on the taskbar by using Windows Flip 3-D</li> </ul> <p><b>Note:</b> Depending on your edition of Windows Vista, some shortcuts may not function as described.</p>
 Application key	<p>This key has the same effect as clicking the right mouse button; it opens the application's context menu.</p>

# Hot Keys

The computer employs hotkeys or key combinations to access most of the computer's controls like screen brightness, volume output and the BIOS utility.

To activate hot keys, press and hold the <Fn> key before pressing the other key in the hotkey combination.



Hotkey	Icon	Function	Description
<Fn> + <F1>	?	Hotkey help	Displays help on hotkeys.
<Fn> + <F2>		Acer eSettings Management	Launches Acer eSettings Management in Acer Empowering Technology.
<Fn> + <F3>		Acer ePower Management	Launches Acer ePower Management in Acer Empowering Technology.
<Fn> + <F4>	Z <sup>Z</sup>	Sleep	Puts the computer in Sleep mode.
<Fn> + <F5>		Display toggle	Switches display output between the display screen, external monitor (if connected) and both.
<Fn> + <F6>		Screen blank	Turns the display screen backlight off to save power. Press any key to return.
<Fn> + <F7>		TouchPad toggle	Turns the internal TouchPad on and off.
<Fn> + <F8>		Speaker toggle	Turns the speakers on and off.
<Fn> + <▷>		Brightness up	Increases the screen brightness.
<Fn> + <◁>		Brightness down	Decreases the screen brightness.

---

## Special Key

You can locate the Euro symbol and the US dollar sign at the upper-center and/or bottom-right of your keyboard.



### The Euro symbol

1. Open a text editor or word processor.
2. Hold <Alt Gr> and then press the <5> key at the upper-center of the keyboard.

**NOTE: Note:** Some fonts and software do not support the Euro symbol. Please refer to [www.microsoft.com/typography/faq/faq12.htm](http://www.microsoft.com/typography/faq/faq12.htm) for more information.

### The US dollar sign

1. Open a text editor or word processor.
2. Hold <Shift> and then press the <4> key at the upper-center of the keyboard.

**NOTE:** This function varies by the operating system version.

# Using the System Utilities

## Acer GridVista (dual-display compatible)

**NOTE:** This feature is only available on certain models.

To enable the dual monitor feature of the notebook, first ensure that the second monitor is connected, then select **Start, Control Panel, Display** and click on **Settings**. Select the secondary monitor (**2**) icon in the display box and then click the check box **Extend my windows desktop onto this monitor**. Finally, click **Apply** to confirm the new settings and click **OK** to complete the process.

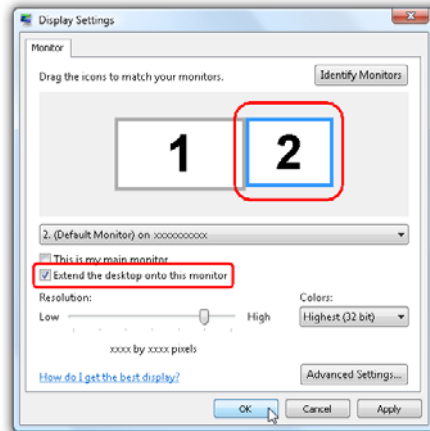

Acer GridVista is a handy utility that offers four pre-defined display settings so you can view multiple windows on the same screen. To access this function, please go to **Start → All Programs** and click on **Acer GridVista**. You may choose any one of the four display settings indicated below:



Double (vertical), Triple (primary at left), Triple (primary at right), or Quad Acer GridVista is dual-display compatible, allowing two displays to be partitioned independently.

Acer GridVista is dual-display compatible, allowing two displays to be partitioned independently.

AcerGridVista is simple to set up:

1. Run Acer GridVista and select your preferred screen configuration for each display from the task bar.
2. Drag and drop each window into the appropriate grid.
3. Enjoy the convenience of a well-organized desktop.

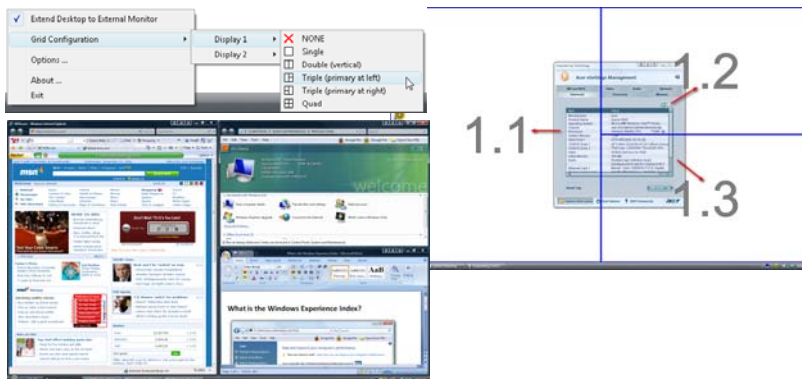

**NOTE:** Please ensure that the resolution setting of the second monitor is set to the manufacturer's recommended value.

# Hardware Specifications and Configurations

## Processor

Item	Specification
CPU	<ul style="list-style-type: none"> <li>• AMD Athlon64 Dual-Core Process, Cache 1MB, TK42</li> <li>• AMD Athlon64 Process, 2.2GHz, Cache 256KB, TF38</li> <li>• AMD Athlon64 Process, 2.0GHz, Cache 256KB, TF36</li> <li>• AMD Athlon64 Process, 1.6GHz, Cache 512KB, TF20</li> </ul>
Type	AMD Athlon64 Dual-Core Mobile CPU
Core Logic	<ul style="list-style-type: none"> <li>• AMDRS780MN</li> <li>• AMDSB710</li> <li>• Integrated VGA solution</li> </ul>
CPU Package	Micro uPGA-638 Package
Power	45W
On-die Cache	Up to 1MB L2 cache
Front Side Bus	667/800/1066MHz

## Processor Specifications

Item	CPU Speed	Cores	Bus Speed	Mfg Tech	Cache Size	Package	Core Voltage	Acer P/N
AATF20	1.6GHz	1	638 MHz		512K	TF20 PGA	15W	KC.ATF02.200
AATK42	1.6GHz	2	638 MHz	65 nm	1M	TK42	20W	KC.ATK02.420

## CPU Fan True Value Table

Fan On Temp (°C)	Fan Speed (rpm)	SPL Spec (dBA)
55	3000	28
60	3300	31
65	3700	34
75	4100	37
80	4500	40

- Throttling 50%: On=90°C, Off=80°C
- OS Shutdown: 95°C
- H/W Shutdown: 92°C

## Northbridge

Item	Specification
Chipset	ATI RS780MN
Package	465 BGA

## Southbridge

Item	Specification
Chipset	ATI SB710
Package	549 BGA

## BIOS

Item	Specification
BIOS vendor	Phoenix BIOS
BIOS Version	V0.11T04

Item	Specification
BIOS ROM type	Flash
Features	<ul style="list-style-type: none"> <li>Flash ROM 1MB</li> <li>Supports ISIPP</li> <li>Supports Acer UI</li> <li>Supports multi-boot</li> <li>Suspend to RAM (S3)/Disk (S4)</li> <li>Various hot-keys for system control</li> <li>Supports SMBUS 2.0, PCI2.3</li> <li>ACPI 2.0 compliance with Intel Speed Step support C1, C2, C3, C4 and S3, S4 for mobile CPU</li> <li>DMI utility for BIOS serial number configurable/asset tag</li> <li>Supports PXE</li> <li>Supports Y2K solution</li> <li>Supports Win Flash Wake on LAN from S3</li> <li>Wake on LAN form S4 in AC mode</li> <li>System information</li> </ul>

### System Memory

Item	Specification
Memory controller	ATI RS780MN + ATI SB710
Memory size	4GB maximum
DIMM socket number	2
Supports memory size per socket	2GB
Supports maximum memory size	4GB (total)
Supports DIMM type	200-pin +1.8V DDRII
Supports DIMM Speed	667/800 MHz
Supports DIMM voltage	1.8V
Cache	Upto 1MB L2 Cache on CPU

### Memory Combinations

Slot 1	Slot 2	Total Memory
0MB	512MB	512MB
0MB	1024MB	1024MB
0MB	2048MB	2048MB
512MB	512MB	1024MB
512MB	1024MB	1536MB
512MB	2048MB	2560MB
1024MB	0MB	1024MB
1024MB	512MB	1536MB
1024MB	1024MB	2048MB
1024MB	2048MB	3072MB
2048MB	0MB	2048MB
2048MB	512MB	2560MB
2048MB	1024MB	3072MB
2048MB	2048MB	4096MB

**NOTE:** Above table lists some system memory configurations. You may combine DIMMs with various



capacities to form other combinations. On above table, the configuration of slot 1 and slot 2 could be reversed.

#### LAN Interface

Item	Specification
LAN Chipset	Atheros AR8132L
Package	
LAN connector type	
LAN connector location	
Feature	
Interface	

#### Wireless Module 802.11b/g/n

Item	Specification	
Manufacturer	Foxconn	
Model	Atheros xb63	Broadcom 4312
<b>802.11g</b>	•	•
Radio Technology		
Operating Frequency		
Modulation Schemes		
Channel Numbers		
Data Rate		
Media Access Protocol		
Transmitter Output Power		
<b>802.11b</b>		
Radio Technology		
Operating Frequency		
Modulation Schemes		
Channel Numbers		
Data Rate		
Media Access Protocol		
Transmitter Output Power		

#### Hard Disk Drive Interface

Item	Specification			
Vendor & Model Name	Seagate ST9160310AS ST9160314AS ST9250315AS ST9320320AS ST9320325AS	Seagate ST9320320AS ST9160310AS	Toshiba MK1655GSX MK1655GSX MK3255GSX MK3263GSX	WD WD1600BEVT WD2500BEVT WD3200BEVT WD5000BEVT
Capacity (MB)	500, 250	320, 160	320, 250, 160	500, 320, 250, 160
Bytes per sector	512	512	512	512
Data heads	4, 2	4, 2	4, 2, 2	4, 4, 3, 2
Drive Format				
Disks	2, 1	2 or 1, 1	2, 1, 1	2, 2, 2, 1
Spindle speed (RPM)	5400	5400	5400	5400

Item	Specification			
Performance Specifications				
Buffer size	8 MB	8 MB	8 MB	8 MB
Interface	SATA	SATA	SATA	SATA
Internal transfer rate (Mbits/sec, max)		352	395~952 (typical)	850 Mbits/s maximum
I/O data transfer rate (Mbytes/sec max)		150	300	300 maximum
DC Power Requirements				
Voltage tolerance	5V $\pm$ 5%	5V $\pm$ 5%	5V $\pm$ 5%	5V $\pm$ 5%

### Super-Multi Drive

Item	Specification			
Vendor & model name	HLDS GT20N		Sony AD7580S	
Performance Specification	With CD Diskette	With DVD Diskette	With CD Diskette	With DVD Diskette
Transfer rate (MB/sec)	Sustained: 3,600 KB/s (24x) max.	Sustained: 11.08 Mbytes/s (8x) max.	Sustained: 1,571 (typical)	Sustained: 10,993 (typical)
Buffer Memory	2 MB			
Interface	SATA			

Item	Specification	
Applicable disc formats	<ul style="list-style-type: none"> <li>DVD-ROM: <ul style="list-style-type: none"> <li>4.7GB (Single Layer)</li> <li>8.5GB (Dual Layer)</li> </ul> </li> <li>DVD-R: <ul style="list-style-type: none"> <li>3.95GB (Ver. 1.0: read only)</li> <li>4.7GB (Ver. 2.0 for Authoring: read only)</li> <li>4.7GB (Ver. 2.1 for General: read &amp; write)</li> <li>(DL) 8.5GB (Ver. 3.0)</li> </ul> </li> <li>DVD-RW: <ul style="list-style-type: none"> <li>4.7GB (Ver. 1.2/ Rev 1.0, 2.0, 3.0)</li> </ul> </li> <li>DVD-RAM: 1.46GB/side, 4.7GB/side (Ver. 2.2)</li> <li>DVD+R: 4.7GB (Ver. 1.3) <ul style="list-style-type: none"> <li>(DL) 8.5GB (Ver. 1.1)</li> </ul> </li> <li>DVD+RW: <ul style="list-style-type: none"> <li>4.7GB (Vol.1 Ver.1.3)</li> </ul> </li> <li>CD-ROM Mode-1 data disc</li> <li>CD-ROM Mode-2 data disc</li> <li>CD-ROM XA, CD-I, Photo-CD Multi-Session, Video CD</li> <li>CD-Audio Disc</li> <li>Mixed mode CD-ROM disc (data and audio)</li> <li>CD-Extra</li> <li>CD-Text</li> <li>CD-R (Conforming to "Orange Book Part 2": read &amp; write)</li> <li>CD-RW (Conforming to "Orange Book Part 3": read &amp; write)</li> </ul>	<p>DVD Read:</p> <p>DVD-ROM (DVD-5, DVD-9, DVD-10, DVD-18), DVD-Video, DVD-Audio, SACD (Hybrid), UDF DVD, DVD-R, DVD-R DL, DVD-R 3.95 GB, DVD-R Authoring, DVD-R Multi-Border, DVD-RW, DVD+R, DVD+R DL, DVD+R Multi-Session, DVD+RW, DVD-RAM V1.0, DVDRAM V2.0 &amp; 2.1 &amp; 2.2.</p> <p>CD Read:</p> <p>CD-DA, CD-ROM Mode-1, CD-ROM/XA Mode-2 Form-1 and Mode-2 Form-2, CD-i, CD-i Bridge, Video-CD (MPEG-1), Karaoke CD, Photo-CD, Enhanced CD, CD Plus, CD Extra, itrax CD, CD-Text, UDF CD, CD-R, and CD-RW</p> <p>DVD Write:</p> <p>DVD Data &amp; Video</p> <p>CD Read:</p> <p>CD-DA, CD-ROM Mode-1, CD-ROM/XA Mode-2 Form-1 and Mode-2 Form-2, CD-i, Video-CD, CD-Text</p>
Loading mechanism	<p>Drawer (Solenoid Open)</p> <p>Tact SW (Open)</p> <p>Emergency Release (draw open hole)</p>	
Power Requirement		
Input Voltage	DC 5 V +/- 5%	

#### Audio Interface

Item	Specification
Chipset	Realtek ALC272X-GR
Package	48-pin LQFP 'Green'
Features	High Definition Audio Codec with Dolby Digital Live

#### Audio Amplifier

Item	Specification
Model	
Package	
Features	•

#### Speakers

Item	Specification
Vendor and Model	

Item	Specification
Dimensions	
Weight	
Nominal Impedance	40hm
Power Rating	2W
Output Sound Pressure Level	
Frequency Range	
Distortion	

#### Microphone

Item	Specification
Vendor and Model	
Directivity	
Current Consumption	
S/N Ratio	
Frequency	

#### Power and Keyboard Controller

Item	Specification
Controller	EM-7T
Package	
Features	<ul style="list-style-type: none"> <li>• Touchpad pointing device</li> </ul>
Supply Current	
Total number of keypads	99-/100-/103-key keyboard
Windows logo key	Yes
Hotkeys	See "Hot Keys" on page 14.

#### Battery

Item	Specification
	6 Cell
Vendor & model name	SANYO/SONY/PANASONIC/SIMPLO AS2009A
Battery Type	Li-ion
Pack capacity	4400 mAh
Normal Voltage	2.2 Ah
Package configuration	3S2P

#### LCD 15.6"

Item	Specification
Vendor/model name	CMO N156B3-L02
Screen Diagonal (mm)	396.2
Display Area (mm)	344.23 x 193.54
Display resolution (pixels)	1366 x 768
Pixel Pitch	0.252
Display Mode	Normal (white)
Typical White Luminance (cd/m <sup>2</sup> ) (also called Brightness)	220

Item	Specification
Contrast Ratio	500:1
Response Time (Optical Rise Time/Fall Time) msec	8
Input Voltage	
Typical Power Consumption (watt)	5.75
Weight (with inverter)	500
Physical Size (mm)	359.3 x 209.5 x 5.9
Electrical Interface	LVDS
Support Color	262K
Viewing Angle (up/down/right/left)	20/45/45/45°
Temperature Range (°C)	
Operating	0 to +50
Storage (shipping)	-20 to +60

#### Fan

Item	Specification
Type	
Pin number	
Speed	
Air flow	
Power	

#### Card Reader

Item	Specification
Part Name	5-in1 card reader
Package	Built-in
General Features	<ul style="list-style-type: none"> <li>• PCI-E interface</li> <li>• Push-push type</li> <li>• Dummy card</li> </ul>



# System Utilities

---

## BIOS Setup Utility

The BIOS Setup Utility is a hardware configuration program built into your computer's BIOS (Basic Input/Output System).

Your computer is already properly configured and optimized, and you do not need to run this utility. However, if you encounter configuration problems, you may need to run Setup. Please also refer to Chapter 4 Troubleshooting when problem arises.

To activate the BIOS Utility, press **F2** during POST (when "Press <F2> to enter Setup" message is prompted on the bottom of screen).

Press **F2** to enter setup. The default parameter of F12 Boot Menu is set to "disabled". If you want to change boot device without entering BIOS Setup Utility, please set the parameter to "enabled".

Press <F12> during POST to enter multi-boot menu. In this menu, user can change boot device without entering BIOS SETUP Utility.

## Navigating the BIOS Utility

There are six menu options: Information, Main, Advanced, Security, Boot, and Exit.

Follow these instructions:

- To choose a menu, use the left and right arrow keys.
- To choose an item, use the up and down arrow keys.
- To change the value of a parameter, press **F5** or **F6**.
- A plus sign (+) indicates the item has sub-items. Press **Enter** to expand this item.
- Press **Esc** while you are in any of the menu options to go to the Exit menu.
- In any menu, you can load default settings by pressing **F9**. You can also press **F10** to save any changes made and exit the BIOS Setup Utility.

**NOTE:** You can change the value of a parameter if it is enclosed in square brackets. Navigation keys for a particular menu are shown on the bottom of the screen. Help for parameters are found in the Item Specific Help part of the screen. Read this carefully when making changes to parameter values. **Please note that system information is subject to different models.**

# eMachines E627 BIOS

## Information

The Information screen displays a summary of your computer hardware information.

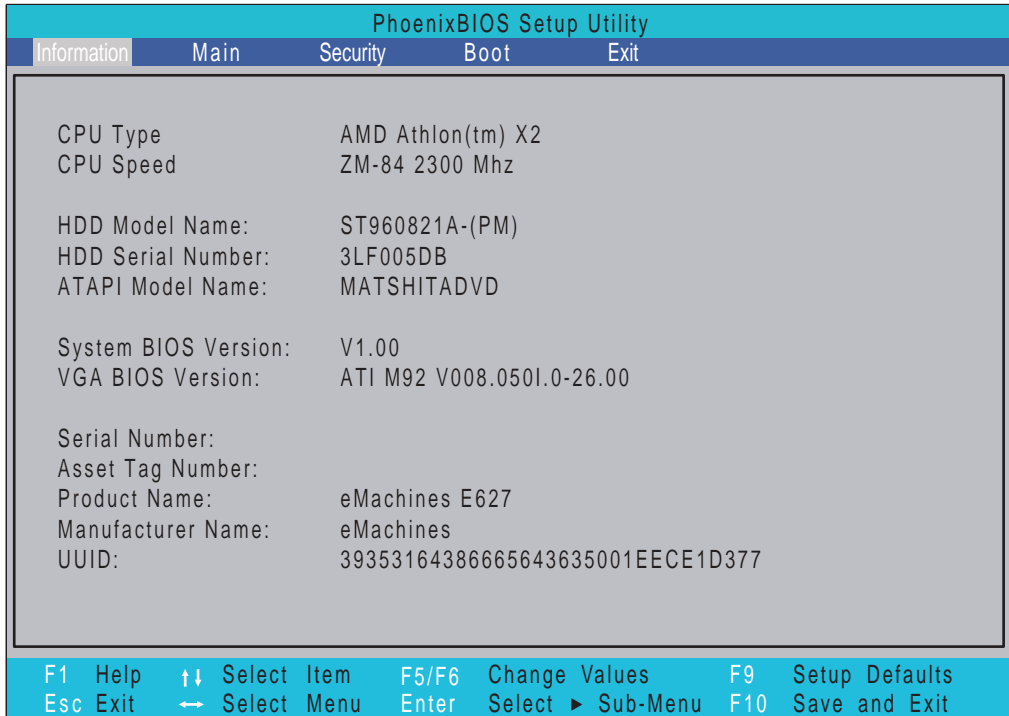

**NOTE:** The screen above is for your reference only. Actual values may differ according to model.

The table below describes the parameters in this screen.

Parameter	Description
CPU Type	This field shows the CPU type and speed of the system.
CPU Speed	This field shows the speed of the CPU.
HDD Model Name	This field shows the model name of HDD installed on primary IDE master.
HDD Serial Number	This field displays the serial number of HDD installed on primary IDE master.
ATAPI Model Name	This field shows the model name of the Optical device installed in the system.
System BIOS Version	Displays system BIOS version.
VGA BIOS Version	This field displays the VGA firmware version of the system.
Serial Number	This field displays the serial number of this unit.
Asset Tag Number	This field displays the asset tag number of the system.
Product Name	This field shows product name of the system.
Manufacturer Name	This field displays the manufacturer of this system.
UUID Number	Universally Unique Identifier (UUID) is an identifier standard used in software construction, standardized by the Open Software Foundation (OSF) as part of the Distributed Computing Environment (DCE).



# Main

The Main screen allows the user to set the system time and date as well as enable and disable boot option and recovery.

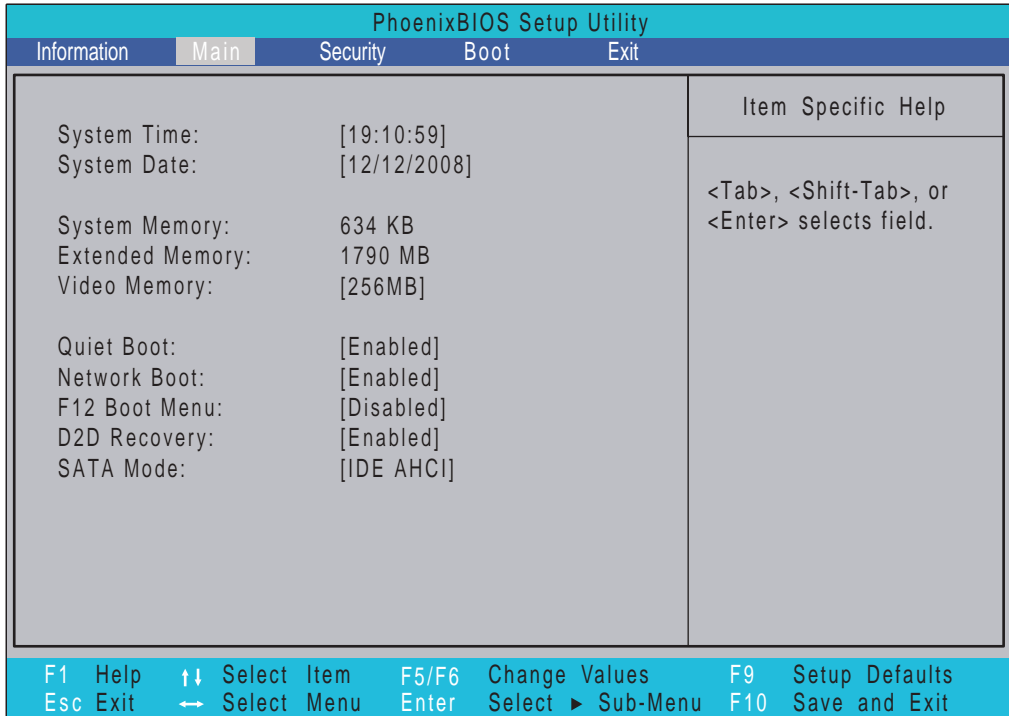

**NOTE:** The screen above is for your reference only. Actual values may differ.

The table below describes the parameters in this screen.

Parameter	Description	Format/Option
System Time	Sets the system time. The hours are displayed with 24-hour format.	Format: HH:MM:SS (hour:minute:second)
System Date	Sets the system date.	Format MM/DD/YYYY (month/day/year)
System Memory	This field reports the memory size of the system.	N/A
Extended Memory	This field reports the Extended Memory size.	N/A
Video Memory	This field shows the memory allocated for the video graphics.	N/A
Quiet Boot	Allows startup to skip certain tests while booting, decreasing the time needed to boot the system.	Option: <b>Enabled</b> or Disabled
Network Boot	Enables, disables the system boot from LAN (remote server).	Option: <b>Enabled</b> or Disabled
F12 Boot Menu	Enables, disables Boot Menu during POST.	Option: <b>Enabled</b> or Enabled
D2D Recovery	Enables, disables D2D Recovery function. The function allows the user to create a hidden partition on hard disc drive to store operation system and restore the system to factory defaults.	Option: <b>Enabled</b> or Disabled
SATA Mode	Control the mode in which the SATA controller should operate.	Option: <b>AHCI</b> or IDE

# Security

The Security screen contains parameters that help safeguard and protect your computer from unauthorized use.

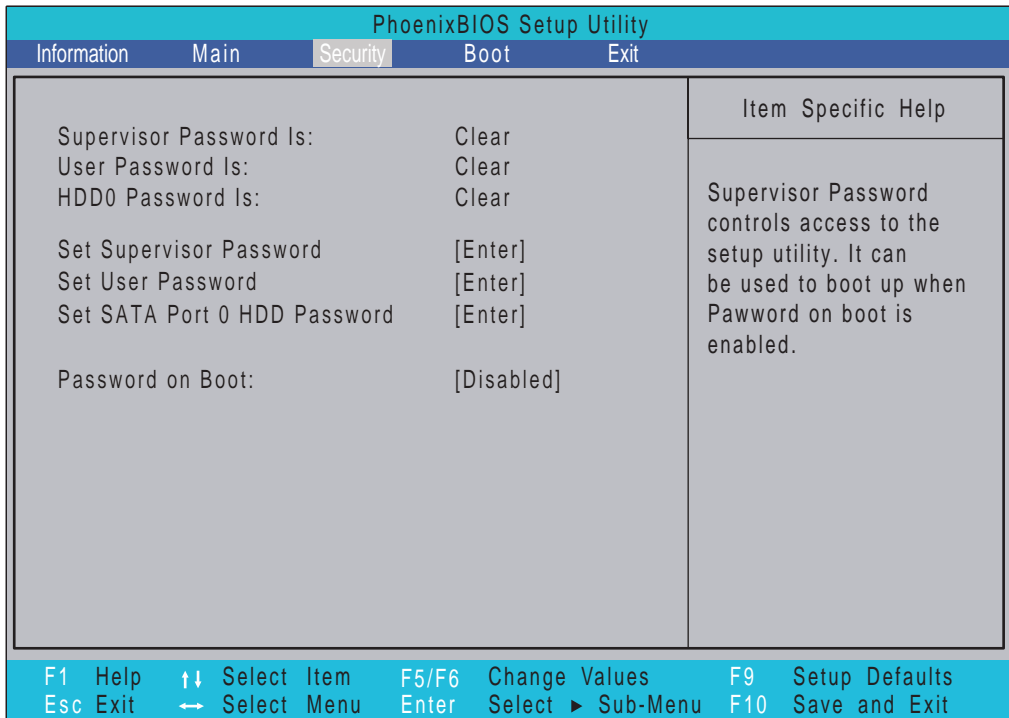

The table below describes the parameters in this screen. Settings in **boldface** are the default and suggested parameter settings.

Parameter	Description	Option
Supervisor Password Is	Shows the setting of the Supervisor password	<b>Clear</b> or Set
User Password Is	Shows the setting of the user password.	<b>Clear</b> or Set
HDD0 Password	Shows the setting of the hard disk password.	<b>Clear</b> or Set
Set Supervisor Password	Press Enter to set the supervisor password. When set, this password protects the BIOS Setup Utility from unauthorized access. The user can not either enter the Setup menu nor change the value of parameters.	N/A
Set User Password	Press Enter to set the user password. When user password is set, this password protects the BIOS Setup Utility from unauthorized access. The user can enter Setup menu only and does not have right to change the value of parameters.	N/A
Set SATA Port0 HDD Password	Enter HDD Password.	N/A
Password on Boot	Defines whether a password is required or not while the events defined in this group happened. The following sub-options are all requires the Supervisor password for changes and should be grayed out if the user password was used to enter setup.	<b>Disabled</b> or Enabled

**NOTE:** When you are prompted to enter a password, you have three tries before the system halts. Don't forget your password. If you forget your password, you may have to return your notebook computer to your dealer to reset it.

---

## Setting a Password

Follow these steps as you set the user or the supervisor password:

1. Use the ↑ and ↓ keys to highlight the Set Supervisor Password parameter and press the **Enter** key. The Set Supervisor Password box appears:

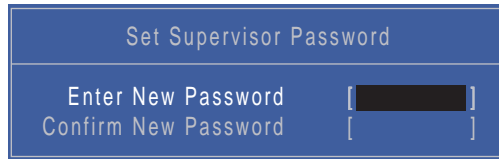

The screenshot shows a blue-bordered window titled "Set Supervisor Password". Inside, there are two input fields: "Enter New Password" and "Confirm New Password". Both fields are currently empty and have a black cursor in the first position.

2. Type a password in the "Enter New Password" field. The password length can not exceed 8 alphanumeric characters (A-Z, a-z, 0-9, not case sensitive). Retype the password in the "Confirm New Password" field.

**IMPORTANT:** Be very careful when typing your password because the characters do not appear on the screen.

3. Press **Enter**. After setting the password, the computer sets the User Password parameter to "Set".
4. If desired, you can opt to enable the Password on boot parameter.
5. When you are done, press F10 to save the changes and exit the BIOS Setup Utility.

## Removing a Password

Follow these steps:

1. Use the ↑ and ↓ keys to highlight the Set Supervisor Password parameter and press the **Enter** key. The Set Password box appears:



The screenshot shows a blue-bordered window titled "Set Supervisor Password". Inside, there are three input fields: "Enter Current Password", "Enter New Password", and "Confirm New Password". The "Enter Current Password" field is currently empty and has a black cursor in the first position. The other two fields are also empty.

2. Type the current password in the Enter Current Password field and press **Enter**.
3. Press **Enter** twice **without** typing anything in the Enter New Password and Confirm New Password fields. The computer then sets the Supervisor Password parameter to "Clear".
4. When you have changed the settings, press u to save the changes and exit the BIOS Setup Utility.

---

## Changing a Password

1. Use the ↑ and ↓ keys to highlight the Set Supervisor Password parameter and press the **Enter** key. The Set Password box appears.



The screenshot shows a blue-themed BIOS screen titled "Set Supervisor Password". It contains three input fields: "Enter Current Password" with a blacked-out field, "Enter New Password" with an empty field, and "Confirm New Password" with an empty field. Each field is followed by a pair of square brackets [ ] indicating the input area.

2. Type the current password in the Enter Current Password field and press **Enter**.
3. Type a password in the Enter New Password field. Retype the password in the Confirm New Password field.
4. Press **Enter**. After setting the password, the computer sets the User Password parameter to "Set".
5. If desired, you can enable the Password on boot parameter.
6. When you are done, press F10 to save the changes and exit the BIOS Setup Utility.

If the verification is OK, the screen will display as following.

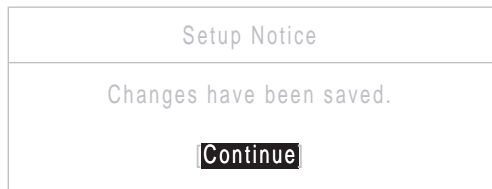

The screenshot shows a white BIOS screen titled "Setup Notice". The text "Changes have been saved." is centered on the screen. Below the text is a black button with the word "Continue" in white.

The password setting is complete after the user presses **Enter**.

If the current password entered does not match the actual current password, the screen will show you the Setup Warning.



The screenshot shows a white BIOS screen titled "Setup Warning" in red text. Below the title, the text "Invalid Password." is displayed in red. At the bottom, there is a black button with the word "Continue" in white.

If the new password and confirm new password strings do not match, the screen will display the following message.



The screenshot shows a white BIOS screen titled "Setup Warning" in red text. Below the title, the text "Passwords do not match. Re-enter password." is displayed in red. At the bottom, there is a black button with the word "Continue" in white.

# Boot

This menu allows the user to decide the order of boot devices to load the operating system. Bootable devices includes the USB diskette drives, the onboard hard disk drive and the DVD drive in the module bay.

Select Boot Devices to select specific devices to support boot.

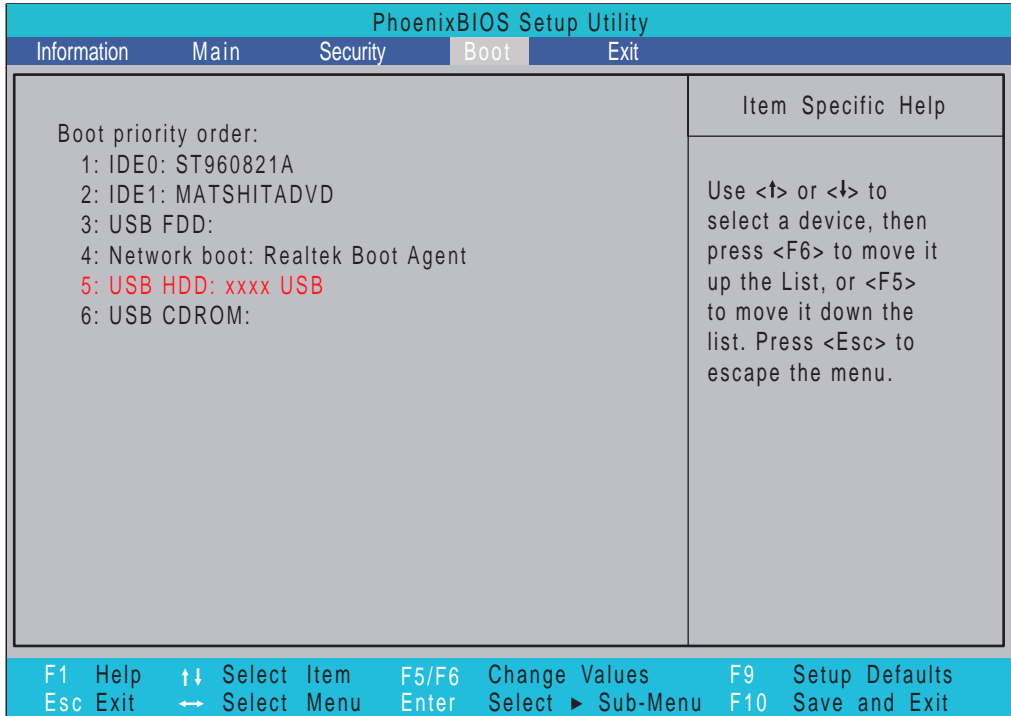

# Exit

The Exit screen allows you to save or discard any changes you made and quit the BIOS Utility.

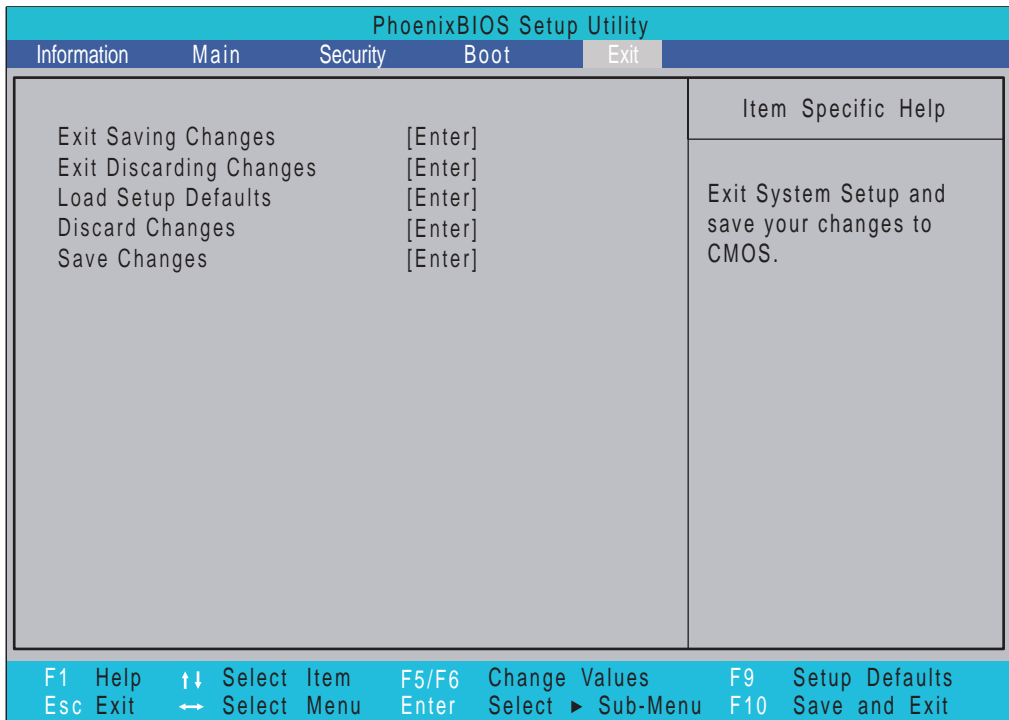

The table below describes the parameters in this screen.

Parameter	Description
Exit Saving Changes	Exit System Setup and save your changes to CMOS.
Exit Discarding Changes	Exit utility without saving setup data to CMOS.
Load Setup Default	Load default values for all SETUP item.
Discard Changes	Load previous values from CMOS for all SETUP items.
Save Changes	Save Setup Data to CMOS.

---

# BIOS Flash Utilities

The BIOS flash memory update is required for the following conditions:

- New versions of system programs
- New features or options
- Restore a BIOS when it becomes corrupted.

Use the Phlash utility to update the system BIOS flash ROM.

**NOTE:** If you do not have a crisis recovery diskette at hand, then you should create a **Crisis Recovery Diskette** before you use the Phlash utility.

**NOTE:** Do not install memory-related drivers (XMS, EMS, DPMI) when you use the Phlash.

**NOTE:** Please use the AC adaptor power supply when you run the Phlash utility. If the battery pack does not contain enough power to finish BIOS flash, you may not boot the system because the BIOS is not completely loaded.

Follow the steps below to run the Phlash.

1. Prepare a bootable diskette.
2. Copy the flash utilities to the bootable diskette.
3. Then boot the system from the bootable diskette. The flash utility has auto-execution function.

# DOS Flash Utility

Perform the following steps to use the DOS Flash Utility:

1. Press F2 during boot to enter the Setup Menu.
2. Select **Boot Menu** to modify the boot priority order, for example, if using USB HDD to Update BIOS, move USB HDD to position 1.

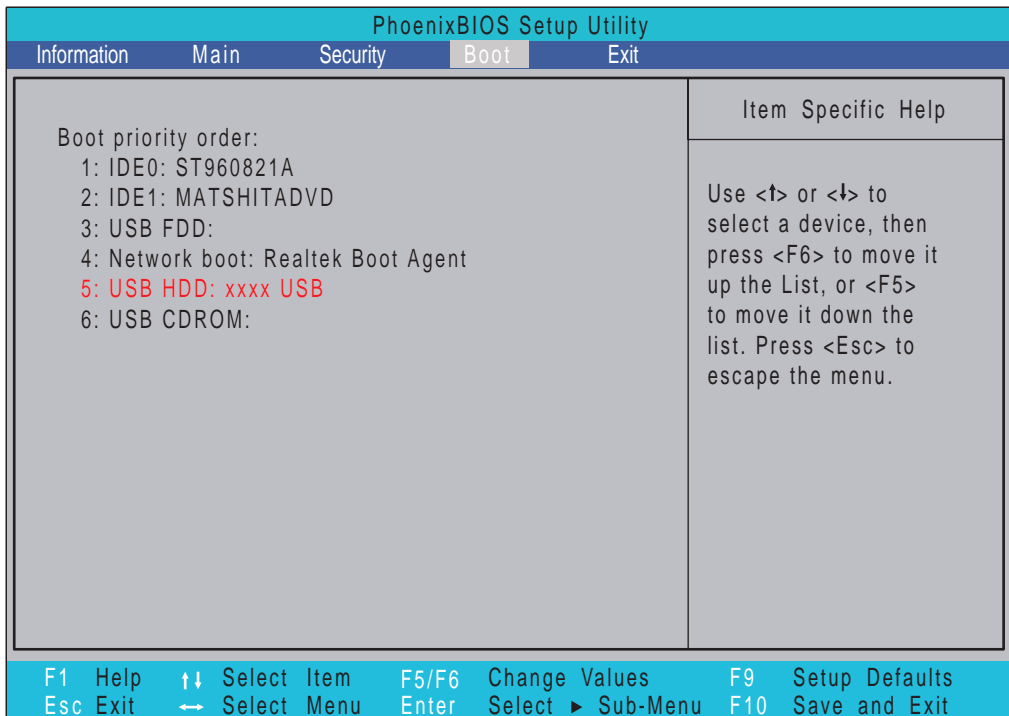

3. Execute the **FLASH.BAT** batch file to update BIOS in DOS mode.

The flash process begins as shown.





- 
4. In flash BIOS, the message **Please do not remove AC Power Source** displays.

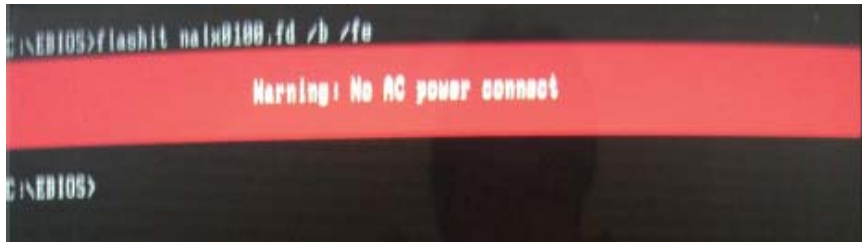

Plug in the AC power to continue.

5. Flash is complete when the message **Flash programming complete** displays.

## WinFlash Utility

Perform the following steps to use the WinFlash Utility:

1. Double-click the WinFlash executable.
  2. Click **OK** to begin the update. WinFlash closes all applications and shuts down the system.
- NOTE:** Place only one \*.wph file with flash32.exe in the same folder when executing this procedure.

---

# Remove HDD/BIOS Password Utilities

This section provides you with details about removing HDD/BIOS password:

## Remove HDD Password:

If you key in the wrong HDD password three times, an error is generated.

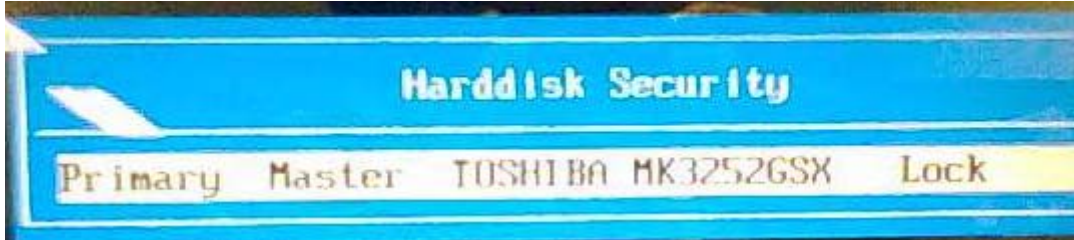

To reset the HDD password, perform the following steps:

1. An error code is generated for unlocking the HDD. Note down this code.



2. Execute the **UnlockHD.EXE** file to create the unlock code in DOS Mode using the format **UnlockHD [Encode code]** with the code noted in the previous step, as follows:

**UnlockHD 76943488**



3. Select 2 to obtain the password. This password which can be used for unlocking the HDD.

**Password :46548274**

4. Shut down the computer by pressing down the Power button for 4 seconds.
5. Turn on the computer and key in the password to unlock the HDD.

### Removing BIOS Passwords:

To clear the User or Supervisor passwords through hardware, open the WLAN door and use a metal instrument to short the **J1** jumper.



### Cleaning BIOS Passwords

To clean the User or Supervisor passwords using software utilities, perform the following steps:

1. From a DOS prompt, execute **clnpwd.exe**

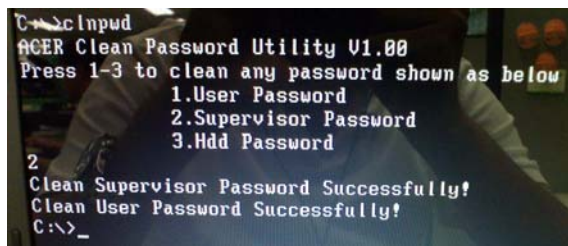

2. Press **1** or **2** to clean the desired password shown on the screen.

The onscreen message determines whether the function is successful or not.



## Using Boot Sequence Selector

The Boot Sequence Selector allows the boot order to be changed without accessing the BIOS. To use Boot Sequence Selector, perform the following steps:

1. Enter into DOS.
2. Execute **BS.exe** to display the usage screen.

```
d:\BOOTSEQ>bs
*** Boot Sequence Selector Version 0.03 ***
Create by Rockwell Chuang 10/01/2005.
Usage:
  BS [ 1 | 2 | 3 | 4 ]
BS 1 : [ Floppy ] => [ HardDisk ] => [ CD-ROM ] => [ LAN ]
BS 2 : [ HardDisk ] => [ CD-ROM ] => [ LAN ] => [ Floppy ]
BS 3 : [ CD-ROM ] => [ HardDisk ] => [ LAN ] => [ Floppy ]
BS 4 : [ LAN ] => [ Floppy ] => [ HardDisk ] => [ CD-ROM ]
d:\BOOTSEQ>
```

3. Select the desired boot sequence by entering the corresponding sequence. For example, enter **BS2** to change the boot sequence to HDD | CD ROM | LAN | Floppy.

---

## Using DMI Tools

The DMI (Desktop Management Interface) Tool copies BIOS information to EEPROM to be used in the DMI pool for hardware management.

When the BIOS displays **Verifying DMI pool data** it is checking that the table correlates with the hardware before sending to the operating system (Windows, etc.).

To update the DMI Pool, perform the following steps:

1. Boot into DOS.
2. Execute **dmitools**. The following messages report to screen to confirm completion:
  - `dmitools /r ==>` Read dmi string from bios
  - `dmitools /wm xxxx ==>` Write manufacturer name to eeprom (max. 16 characters)
  - `dmitools /wp xxxx ==>` Write product name to eeprom (max. 16 characters)
  - `dmitools /ws xxxx ==>` Write serial number to eeprom (max. 22 characters)
  - `dmitools /wu xxxx ==>` Write uuid to eeprom
  - `dmitools /wa xxxx ==>` Write asset tag to eeprom (max. 32 characters)

The following examples show the commands and the corresponding output information.

### Read DMI Information from Memory

#### Input:

```
dmitools /r
```

#### Output:

```
Manufacturer (Type1, Offset04h): Acer
Product Name (Type1, Offset05h): TravelMate xxxxx
Serial Number (Type1, Offset07h): 01234567890123456789
UUID String (Type1, Offset08h): xxxxxxxx-xxxx-xxxx-xxxx-xxxxxxxxxxxx
Asset Tag (Type3, Offset04h): Acet Asstag
```

### Write Product Name to EEPROM

#### Input:

```
dmitools /wp Acer
```

### Write Serial Number to EEPROM

#### Input:

```
dmitools /ws 01234567890123456789
```

### 4 ). Write UUID to EEPROM ( Create UUID from Intel WFM20.pdf )

#### Input:

```
dmitools /wu
```

### 5). Write Asset Tag to EEPROM

#### Input:

```
dmitools /wa Acer Asstag
```

**NOTE:** When using any of the Write options, restart the system to make the new DMI data effective.

---

## Using the LAN MAC EEPROM Utility

You can use the MAC.BAT utility to write the MAC.CFG file to the EEPROM under DOS mode.

1. Use a text editor (for example: Notepad) to open the MAC.CFG file. You can see the MAC.CFG contents as below:



```
MAC.CFG - 記事本
檔案(F) 編輯(E) 格式(O) 檢視(V) 說明(H)
Title= MAC Address byte
WriteData='001122334455'
StartAddr=7A
WriteLeng=6
KeepByte=0
```

WriteData = '001122334455'	MAC value
StartAddr=7A	MAC address
WriteLeng=6	MAC value length
KeepByte=0	don't care

2. In DOS mode, run the **MAC.BAT** file to write MAC values to eeprom.

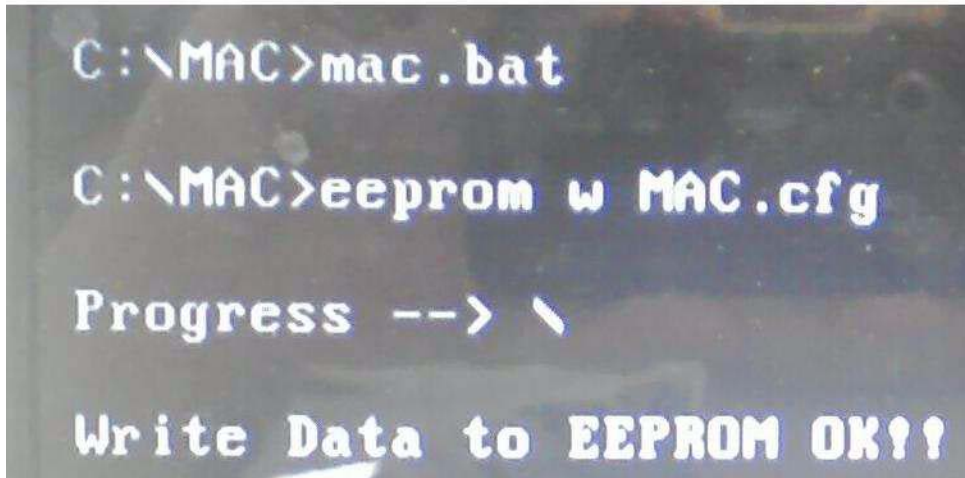

```
C:\MAC>mac.bat
C:\MAC>eeprom w MAC.cfg
Progress --> \
Write Data to EEPROM OK!!
```

# Machine Disassembly and Replacement

---

**IMPORTANT:** The outside housing and color may vary from the mass produced model.

This chapter contains step-by-step procedures on how to disassemble the notebook computer for maintenance and troubleshooting.

## Disassembly Requirements

To disassemble the computer, you need the following tools:

- Wrist grounding strap and conductive mat for preventing electrostatic discharge
- Flat screwdriver
- Philips screwdriver
- Plastic flat screwdriver
- Plastic tweezers

**NOTE:** The screws for the different components vary in size. During the disassembly process, group the screws with the corresponding components to avoid mismatch when putting back the components.



---

# Pre-disassembly Instructions

Before proceeding with the disassembly procedure, make sure that you do the following:

1. Turn off the power to the system and all peripherals.
2. Unplug the AC adapter and all power and signal cables from the system.



3. Place the system on a flat, stable surface.
4. Remove the battery pack.

## Disassembly Process

**IMPORTANT:** The LCD Module cannot be disassembled outside of factory conditions. If any part of the LCD Module is faulty, such as the camera, antenna or LCD panel, the whole module must be replaced.

The disassembly process is divided into the following stages:

- External module disassembly
- Main unit disassembly
- LCD module disassembly

The flowcharts provided in the succeeding disassembly sections illustrate the entire disassembly sequence. Observe the order of the sequence to avoid damage to any of the hardware components. For example, if you want to remove the mainboard, you must first remove the keyboard, then disassemble the inside assembly frame in that order.

### Main Screw List

Screw	Quantity	Part Number
SCREW M2.5*4	1	86.N2802.001
SCREW M2.5*6	10	86.N2802.002
SCREW M2.5*8	30	86.N2802.003
SCREW M2*3	17	86.N2802.004
SCREW M3*3	4	86.N2802.005



# External Module Disassembly Process

**IMPORTANT:** The outside housing and color may vary from the mass produced model.

## External Modules Disassembly Flowchart

The flowchart below gives you a graphic representation of the external module disassembly sequence and instructs you on the components that need to be removed during servicing. For example, if you want to remove the keyboard, you must first remove the switch board.

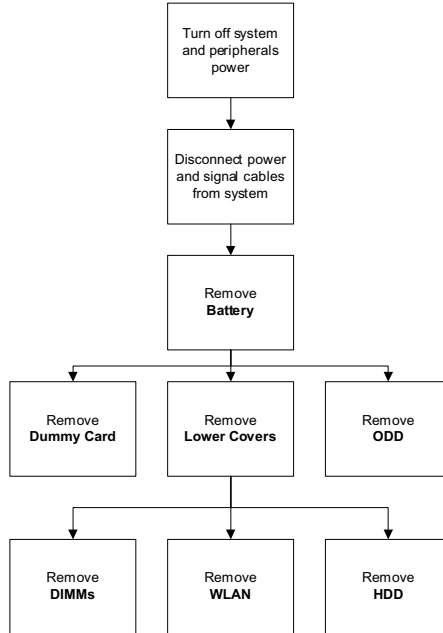

### Screw List

Step	Screw	Quantity	Part No.
Lower Covers	M2.5*8	3	86.N2802.003
ODD Module	M2.5*8	1	86.N2802.003
WLAN Module	M2*3	2	86.N2802.004
HDD Carrier	M3*3	4	86.N2802.005

---

## Removing the Battery Pack

1. Turn computer over. Slide the battery lock in the direction shown.



2. Slide and hold the battery release latch to the release position (1), then lift out the battery pack from the main unit (2).

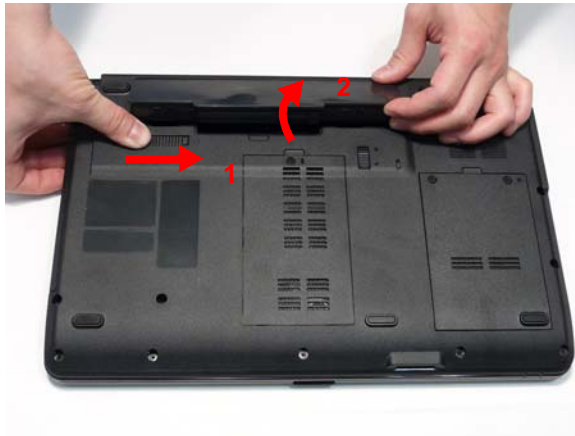

---

## Removing the SD Dummy Card

1. Push the SD dummy card all the way in to eject it.



2. Pull it out from the slot.



# Removing the Lower Covers

- 1. See "Removing the Battery Pack" on page 44.
- 2. Remove the three screws securing the Memory and HDD Covers.



Step	Size	Quantity	Screw Type
Lower Covers	M2.5*8	3	

- 3. Remove the HDD cover as shown.



- 4. Carefully open the Memory Cover.



## Removing the Optical Drive Module

1. See "Removing the Battery Pack" on page 44.
2. Remove the screw securing the ODD module.



Step	Size	Quantity	Screw Type
ODD Module	M2.5*8	1	

3. Insert a suitable tool into the access slot in the battery bay as shown. Gently lever the ODD module out of the chassis.
4. Pull the optical drive module out from the chassis.



5. Remove the two screws securing the ODD bracket and remove the ODD bracket from the optical disk drive module.



Step	Size	Quantity	Screw Type
ODD Bracket	M2*3	2	

6. Remove the ODD bezel by rotating the top edge downward and pulling it clear of the module.



---

## Removing the DIMM Modules

1. See “Removing the Lower Covers” on page 46.
2. Push out the release latches on both sides of the DIMM socket to release the DIMM module.

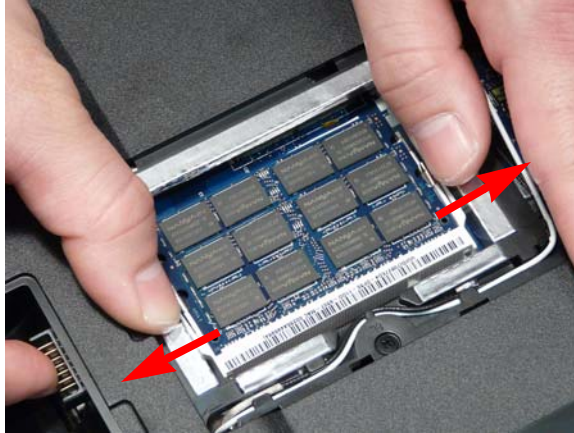

3. Remove the DIMM module.

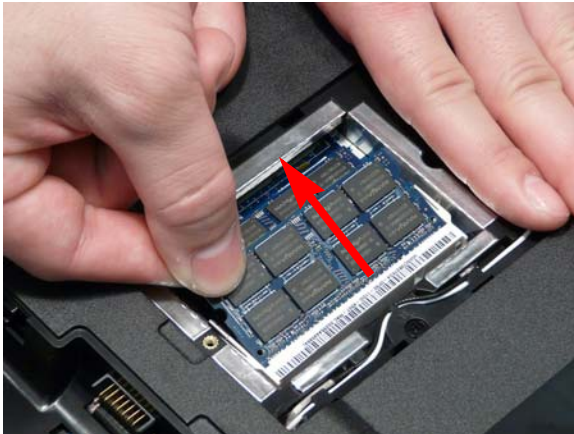

4. Repeat steps for the second DIMM module if present.



---

## Removing the WLAN Module

1. See “Removing the Lower Covers” on page 46.
2. Remove the adhesive tape securing the Antenna cables in place.

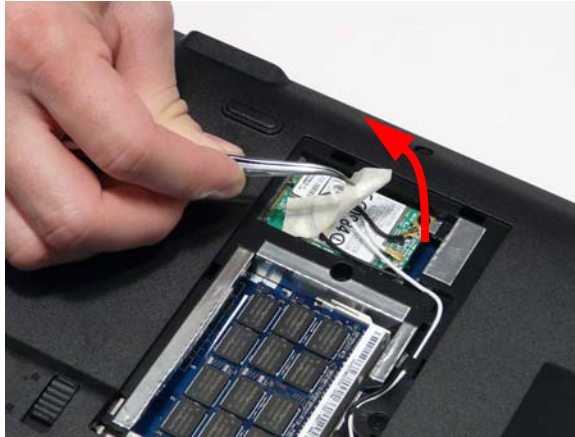

3. Disconnect the antenna cables from the WLAN Board.



**NOTE:** Cable placement is **Black** to the **MAIN** terminal (upper) and **White** to the **AUX** terminal (lower).



4. Move the antenna away and remove the two screws to release the WLAN Board.



Step	Size	Quantity	Screw Type
WLAN Module	M2*3	2	

5. Detach the WLAN Board from the WLAN socket.



**NOTE:** When reattaching the antennas, ensure the cables are tucked into the chassis to prevent damage.

---

## Removing the Hard Disk Drive Module

1. See “Removing the Lower Covers” on page 46.
2. Using the pull-tab, slide the HDD Module in the direction of the arrow to disconnect the interface.



3. Lift the HDD Module clear of the HDD bay.



**NOTE:** To prevent damage to device, avoid pressing down on it or placing heavy objects on top of it.

4. Remove the four screws (two each side) securing the hard disk to the carrier.



Step	Size	Quantity	Screw Type
HDD Carrier	M3*3	4	

5. Remove the HDD from the carrier.



# Main Unit Disassembly Process

## Main Unit Disassembly Flowchart

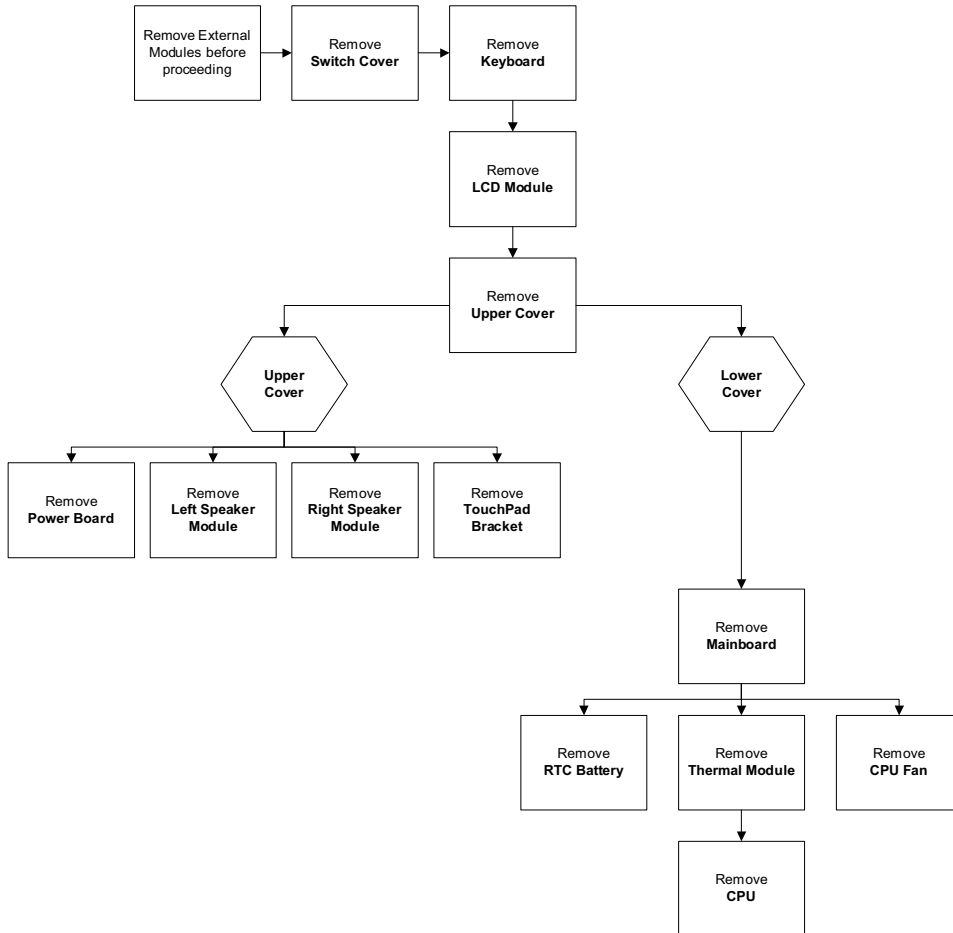

### Screw List

Step	Screw	Quantity	Part No.
LCD Module	M2.5*8	2	86.N2802.003
LCD Module	M2.5*8	4	86.N2802.003
Upper Cover	M2.5*8	11	86.N2802.003
Upper Cover	M2.5*8	9	86.N2802.003
Power Board	M2*3	2	86.N2802.004
Left Speaker Module	M2*3	1	86.N2802.004
Right Speaker Module	M2*3	1	86.N2802.004
TouchPad Bracket	M2*3	2	86.N2802.004
Mainboard	M2.5*4	1	86.N2802.001
Thermal Module	M2.5*6	4	86.N2802.002
CPU Fan	M2*3	3	86.N2802.004

---

## Removing the Switch Cover

**CAUTION:** Using metal tools to remove the Switch Cover may cause damage to the outer casing. The use of plastic tools or fingers is recommended to remove the Switch Cover.

1. See “Removing the Battery Pack” on page 44.
2. Turn the computer over. Press down the / and \* keys on the right side of the Keyboard to expose the cutout. Insert a suitable plastic tool (or finger) and pry the Switch Cover upward, away from the Upper Cover.



3. Work along the Switch Cover toward the left hinge, gently prying up the cover as shown.



4. Lift the Switch Cover clear of the computer.



## Removing the Keyboard

1. See "Removing the Switch Cover" on page 55.
2. Pry up the centre of the Keyboard and rotate it upward away from the Upper Cover.



3. Turn the keyboard over on to the TouchPad area to expose the FFC connector.



4. Open the locking latch and disconnect the FFC from the mainboard.

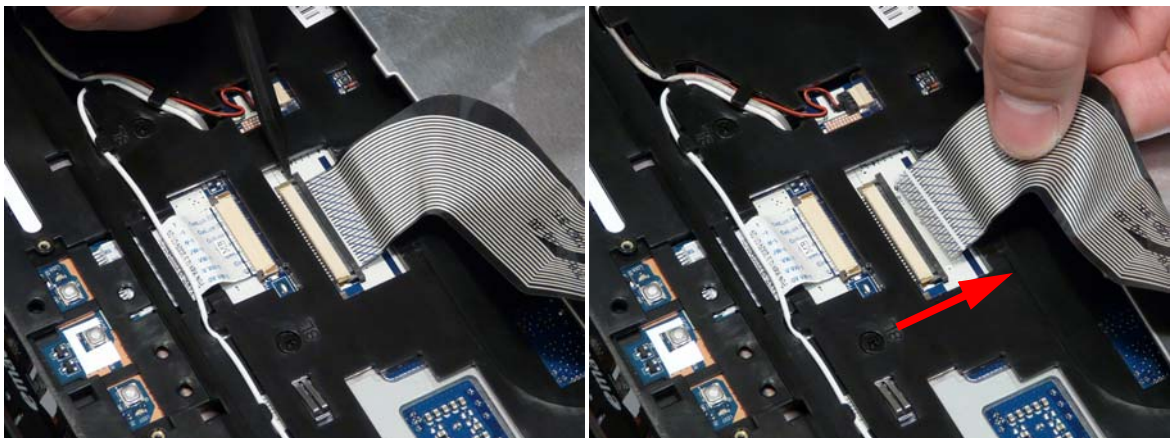

5. Lift the keyboard clear of the Upper Cover.



# Removing the LCD Module

1. See "Removing the Keyboard" on page 56.
2. Turn the computer over. Remove the two securing screws from the bottom of the chassis.



Step	Size	Quantity	Screw Type
LCD Module	M2.5*8	2	

3. Remove the Antenna Cables from the cable channel as shown. Ensure that the cables are free from all cable clips.

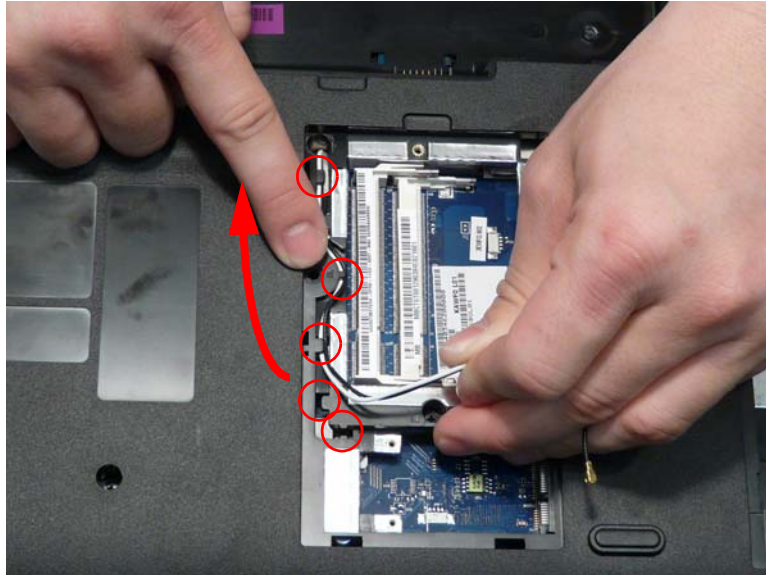

4. Stand the computer on the LCD Panel and pull the Antenna cables completely through the chassis.



5. Disconnect the LCD cable from the Mainboard and remove the cable from the cable channel.

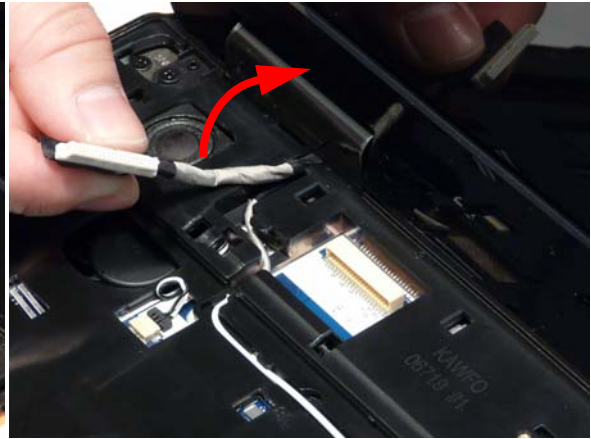
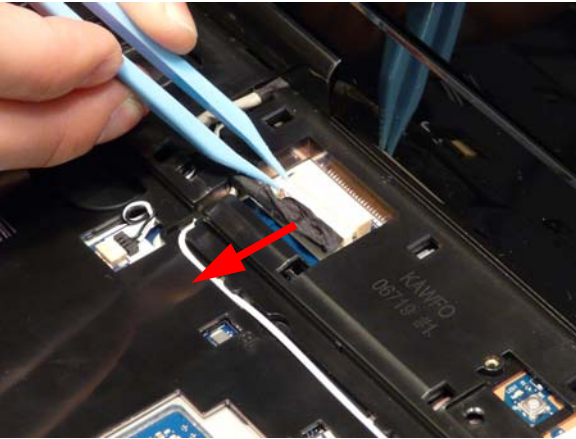

6. Remove the white Antenna cable from the cable channel. Ensure that the cable is completely free of the retaining clips all the way to the hinge well.

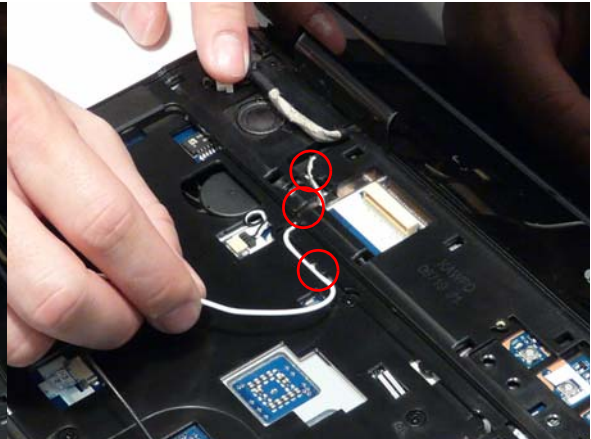
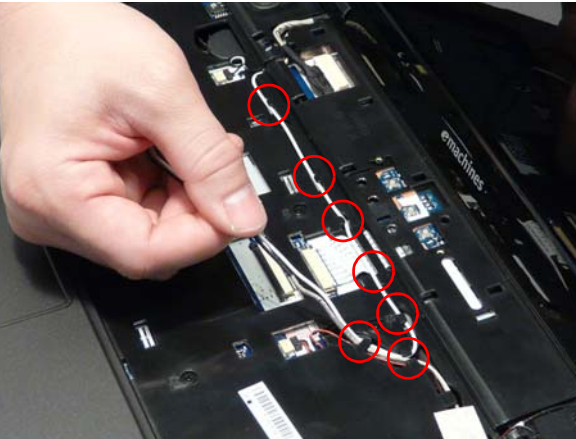



7. Remove the adhesive tape securing the Antenna cable to the Upper Cover.

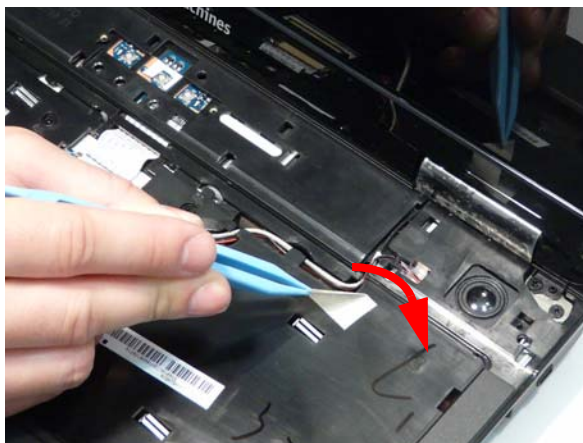

8. Remove the black Antenna cable from the cable channel as shown. Ensure that the cable is completely free of the retaining clips all the way to the hinge well.

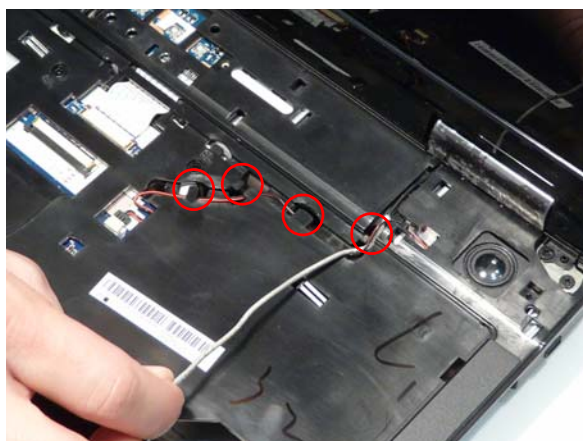

9. Open the LCD Panel to the full extent to expose the Hinge Covers.

10. Press the left side Hinge Cover inward, as shown, and lift to remove the cover from the chassis.



11. Repeat the process for the right side Hinge Cover.

12. Remove the four securing screws (two each side) from the LCD module.

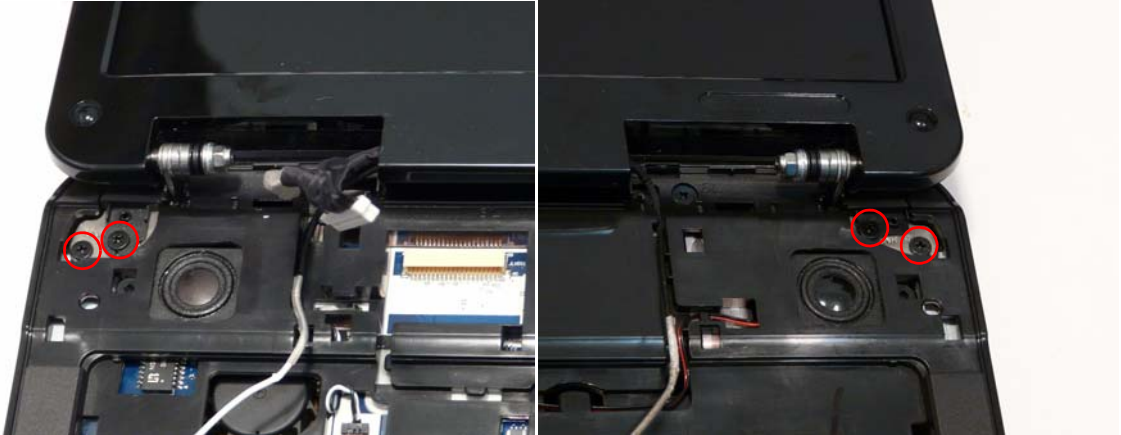

Step	Size	Quantity	Screw Type
LCD Module	M2.5*8	4	

13. Remove the left and right screw covers from on top of the hinges

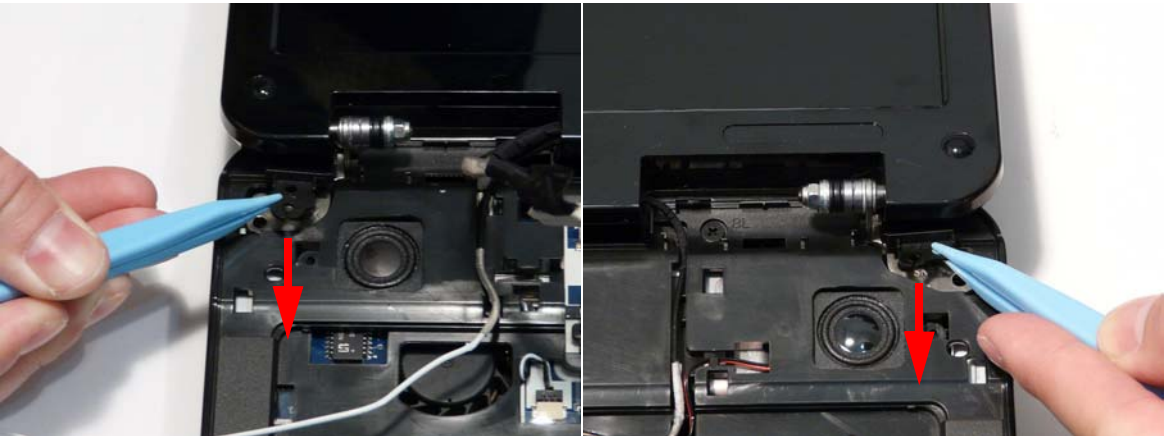

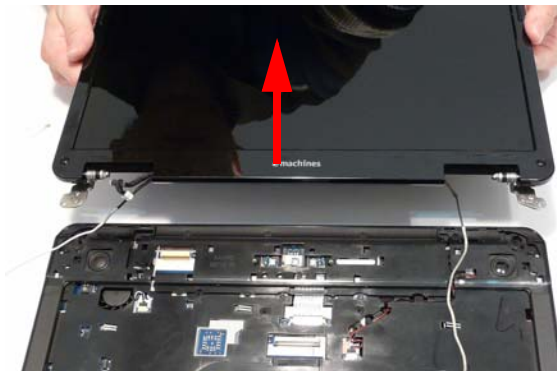

14. Lift the LCD Module clear of the Upper Cover.

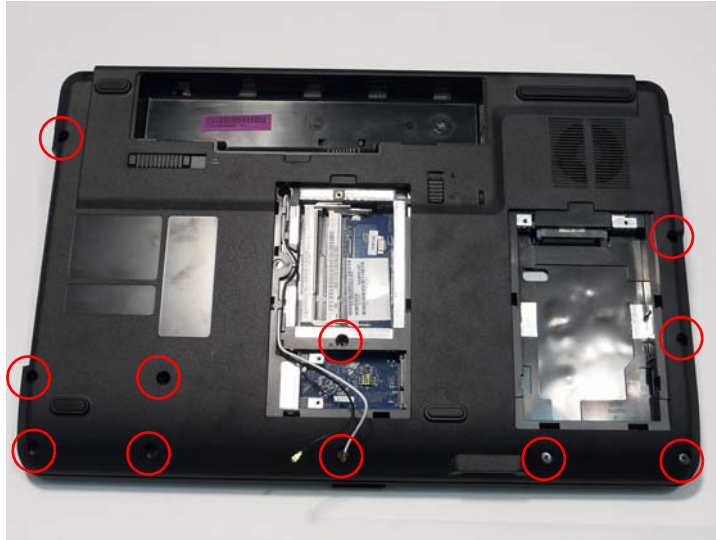

## Removing the Upper Cover

1. See "Removing the LCD Module" on page 57.
2. Turn the computer over. Remove the eleven screws on the bottom panel.



Step	Size	Quantity	Screw Type
Upper Cover	M2.5*8	11	

3. Turn the computer over. Remove the three screw caps at the rear of the Upper Cover as shown.

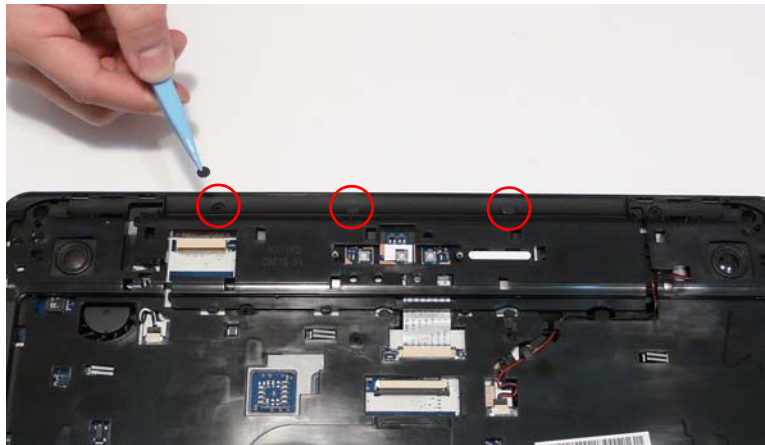

---

4. Disconnect the following four cables from the Mainboard.

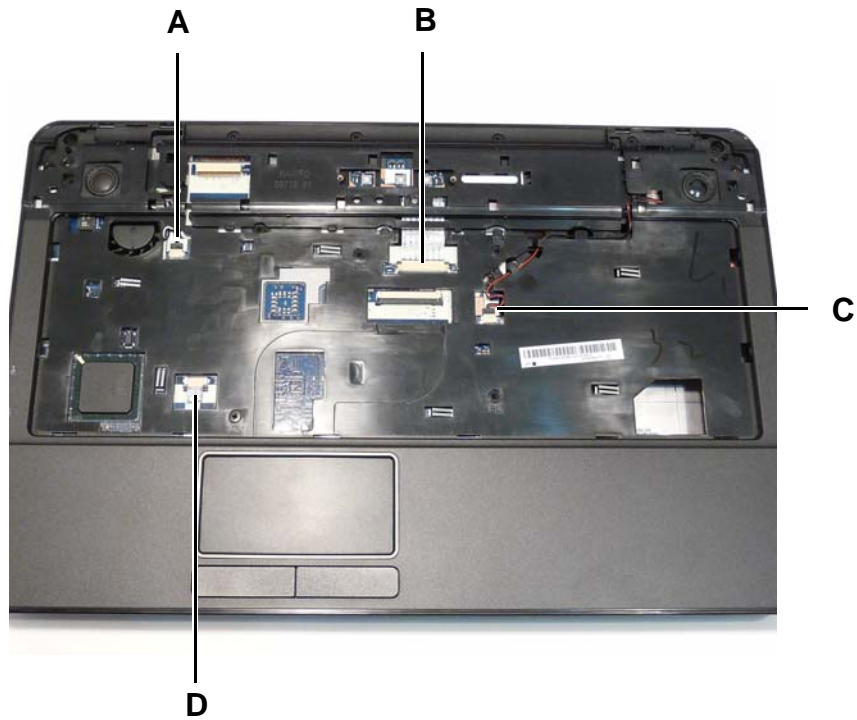



5. Disconnect **A** as shown.

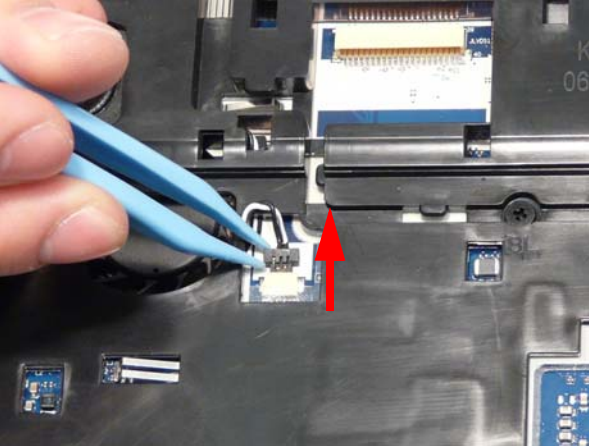

6. Disconnect **C** as shown.

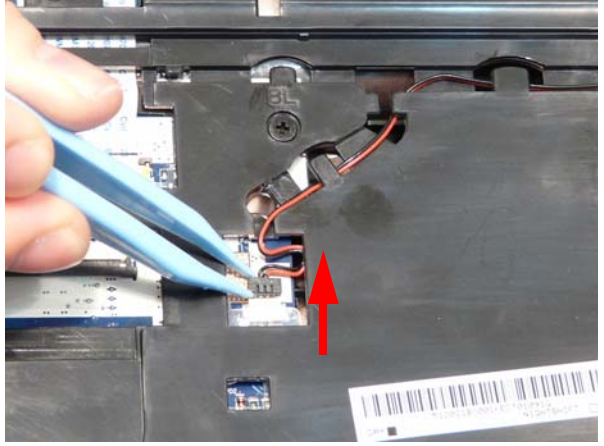

7. Release the locking latch on **B** and remove the FFC cable as shown.

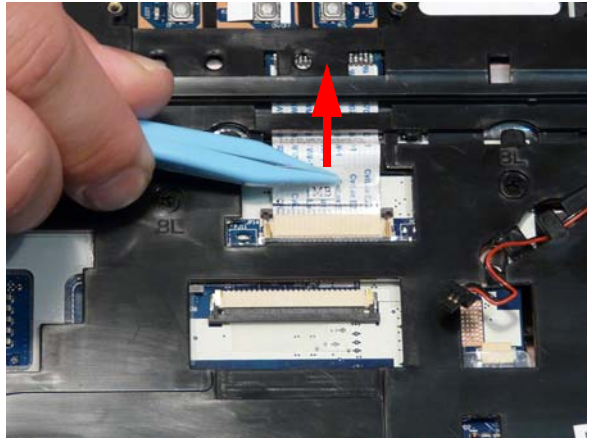
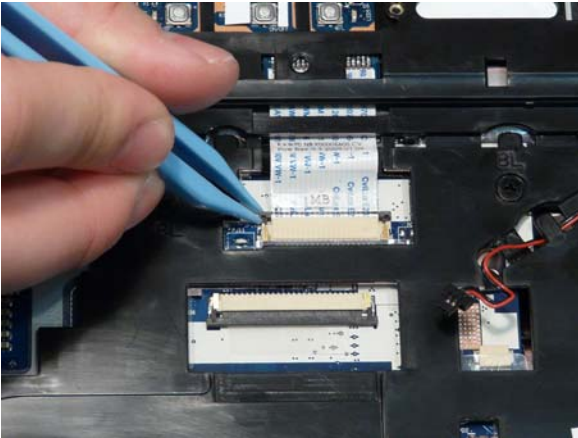

8. Release the locking latch on **D** and remove the FFC cable as shown.

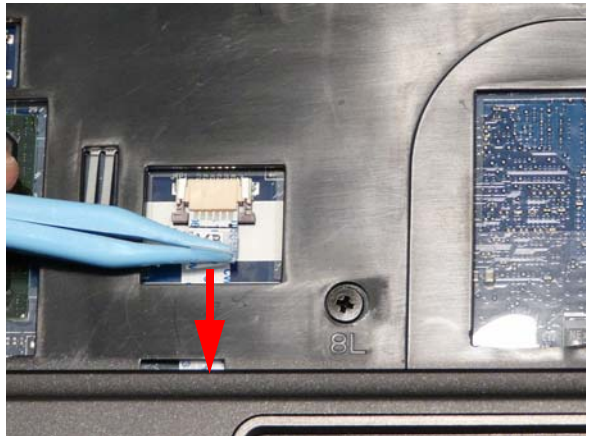

**NOTE:** Avoid pulling on cables directly to prevent damage to the connectors.

**NOTE:** Use the pull-tabs on FFCs whenever available to prevent damage.

9. Remove the nine screws on the top panel.

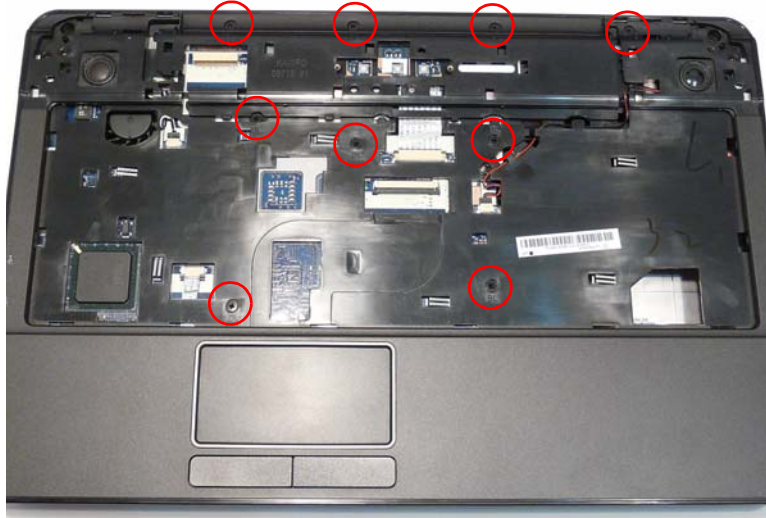

Step	Size	Quantity	Screw Type
Upper Cover	M2.5*8	9	

10. Starting at the rear left side of the cover, pry apart the Upper and Lower Covers as shown. Work along the back edge of the casing to the right as shown, then lift the Upper Cover clear of the Lower Cover.



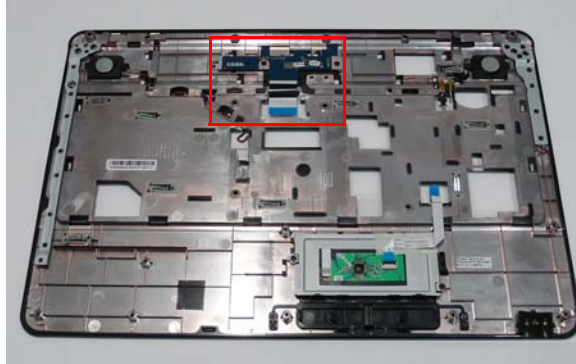

## Removing the Power Board

1. See "Removing the Upper Cover" on page 61.
2. Locate the Power Board on the Upper Cover as shown.

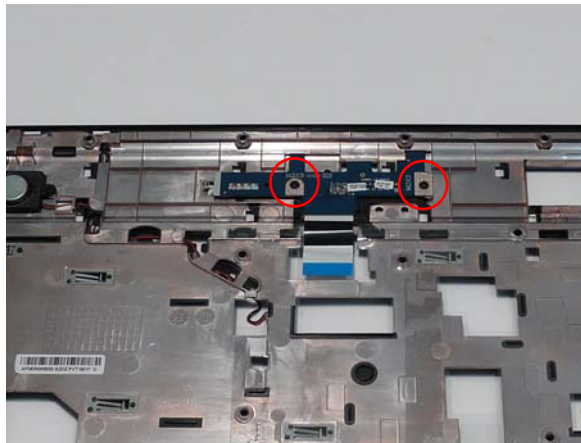

3. Remove the two screws securing the Power Board to the Upper Cover.



Step	Size	Quantity	Screw Type
Power Board	M2*3	2	

4. Lift the Power Board clear of the Upper Cover as shown.

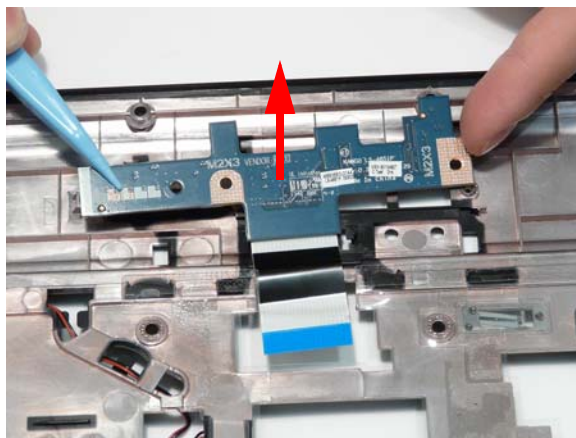



---

## Removing the Left Speaker Module

1. See "Removing the Upper Cover" on page 61.
2. Locate the Left Speaker Module on the Upper Cover as shown.

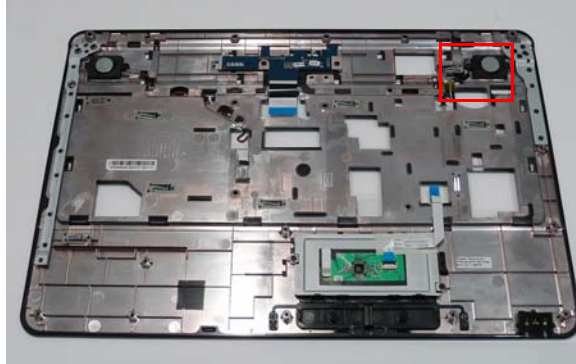

3. Remove the adhesive tape from the Speaker cable.



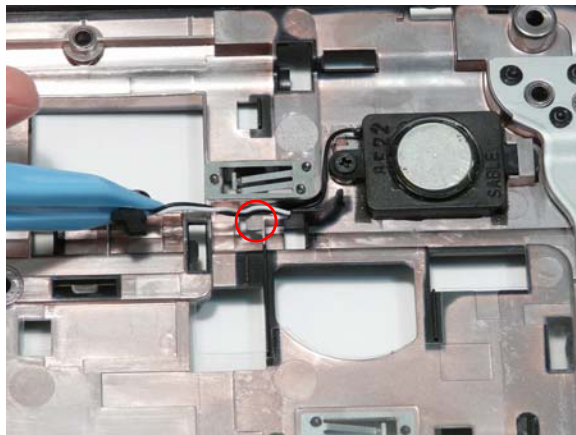

4. Remove the Speaker cable from the cable channel. Ensure that the cable is free from all cable clips.



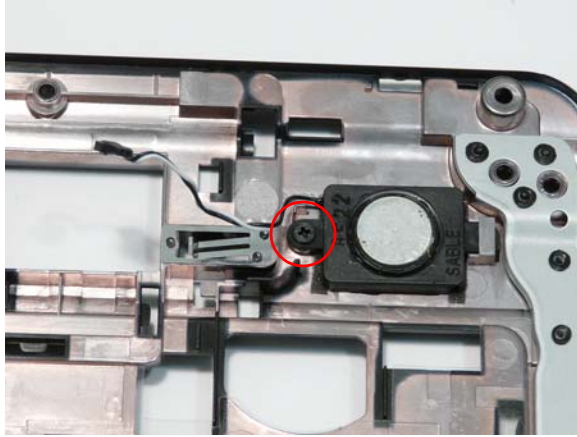

5. Remove the single securing screw from the Left Speaker Module.



Step	Size	Quantity	Screw Type
Left Speaker Module	M2*3	1	

6. Lift the Speaker clear of the Upper Cover, left side first as shown.

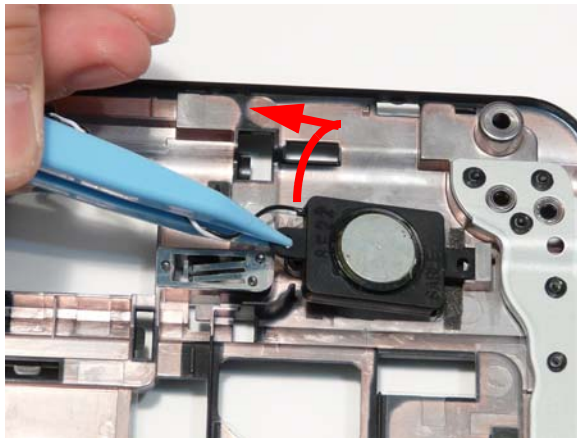

---

## Removing the Right Speaker Module

1. See "Removing the Upper Cover" on page 61.
2. Locate the Right Speaker Module on the Upper Cover as shown.

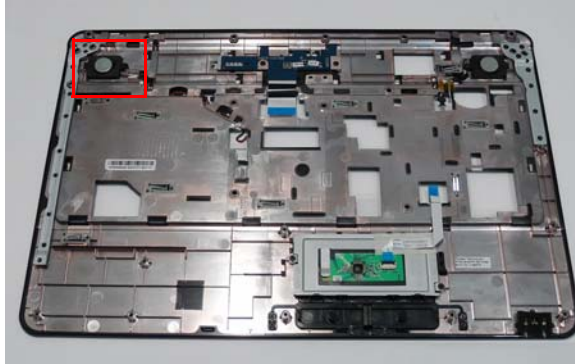

3. Turn the Upper Cover over and remove the Right Speaker Module cable from the cable channel. Ensure that the cable is free from all cable clips.

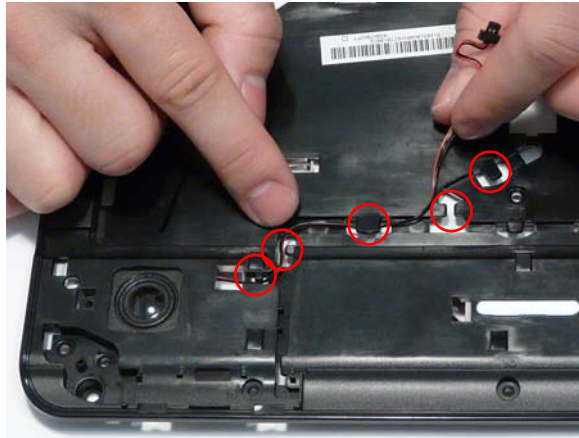

4. Turn the Upper Cover over and pass the cable through the cover as shown.

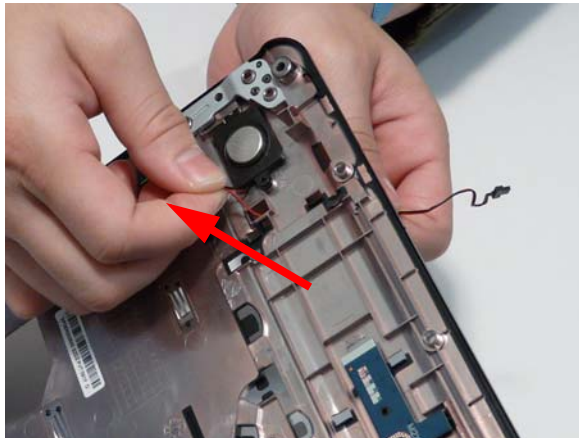

5. Remove the single securing screw from the Right Speaker Module.



Step	Size	Quantity	Screw Type
Right Speaker Module	M2*3	1	

6. Lift the Speaker clear of the Upper Cover, right side first as shown.



---

## Removing the TouchPad Bracket

**IMPORTANT:** The TouchPad Board cannot be removed individually. To replace the TouchPad Board, replace the entire Upper Cover.

1. See “Removing the Upper Cover” on page 61.
2. Lift the FFC to detach the adhesive securing the cable to the Upper Cover.

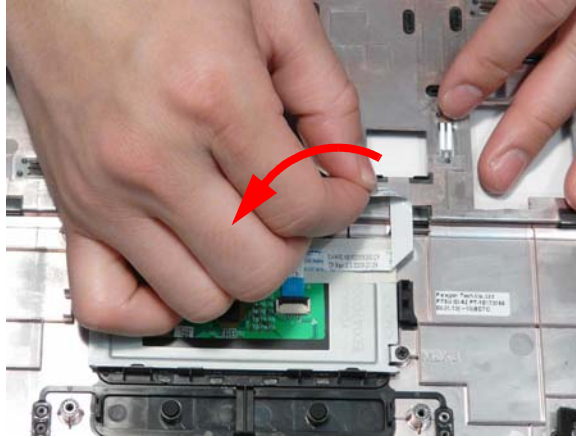

3. Release the FFC locking latch and disconnect the TouchPad FFC from the cover.

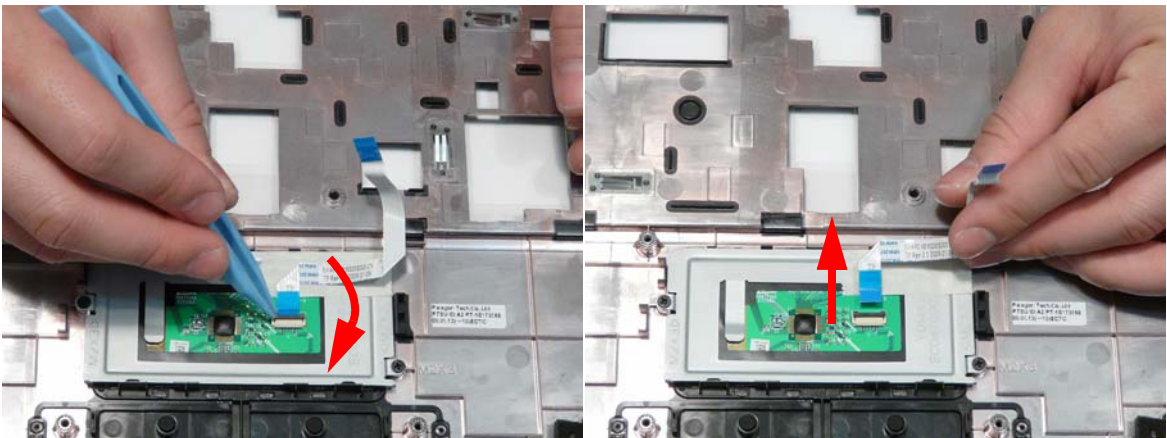

4. Remove the two screws from TouchPad bracket.

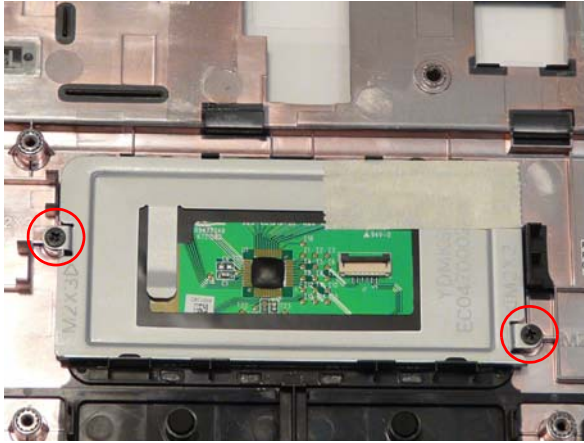

Step	Size	Quantity	Screw Type
TouchPad Bracket	M2*3	2	

5. Lift the rear edge of the TouchPad bracket first to clear the securing clips and remove it as shown.

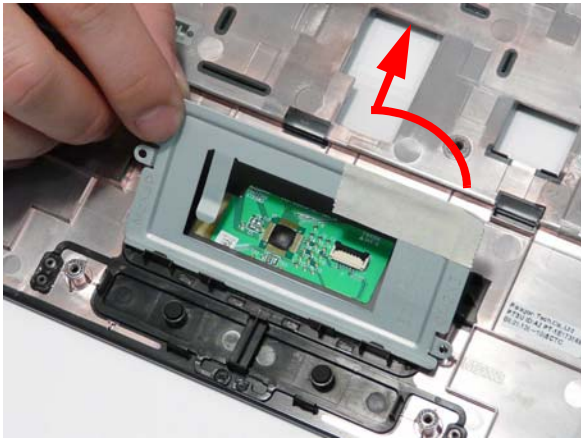



# Removing the Mainboard

- 1. See "Removing the Upper Cover" on page 61.
- 2. Remove the single securing screw from the Mainboard.

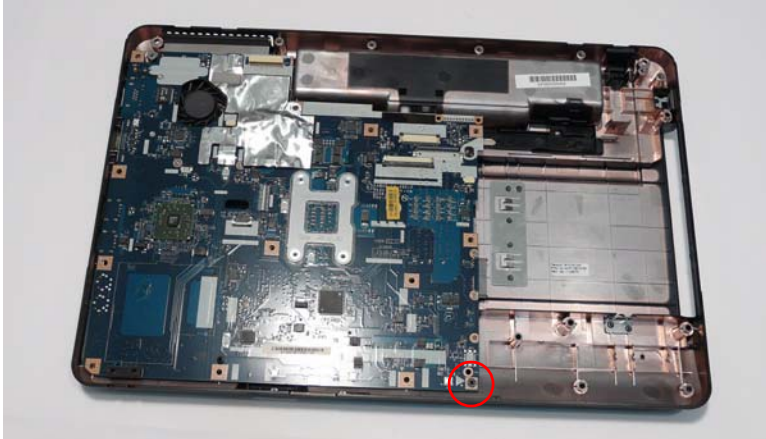

Step	Size	Quantity	Screw Type
Mainboard	M2.5*4	1	

- 3. Lift the mainboard from the chassis, right edge first, and place it on a clean, dust-free surface.

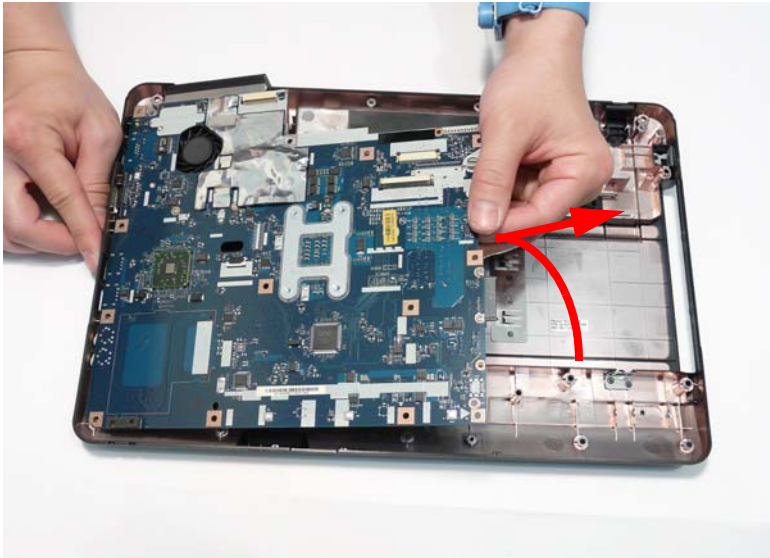

---

## Removing the RTC Battery

**IMPORTANT:** Follow local regulations for disposal of all batteries.

The RTC Battery is soldered to the Mainboard. To replace the battery, solder the new battery to the connections shown.



# Removing the Thermal Module

1. See "Removing the Lower Covers" on page 46.
2. Turn the Mainboard over to access the Thermal Module.



3. Remove the four securing screws (in reverse numerical order from screw 4 to screw 1) from the Thermal Module.



Step	Size	Quantity	Screw Type
Thermal Module	M2.5*6	4	



---

4. Using both hands, lift the Thermal Module clear of the Mainboard.

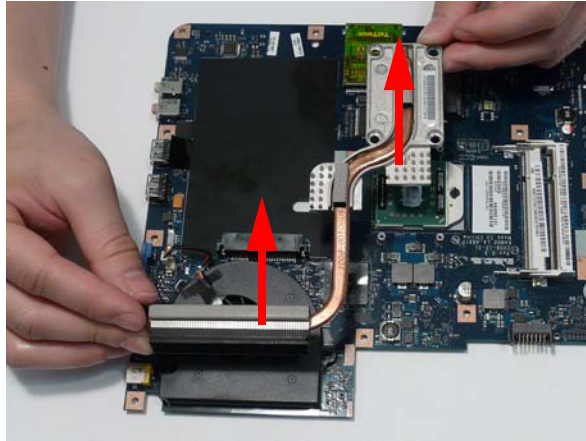



## Removing the CPU Fan

1. See "Removing the Thermal Module" on page 74.
2. Disconnect the Fan cable from the Mainboard as shown.

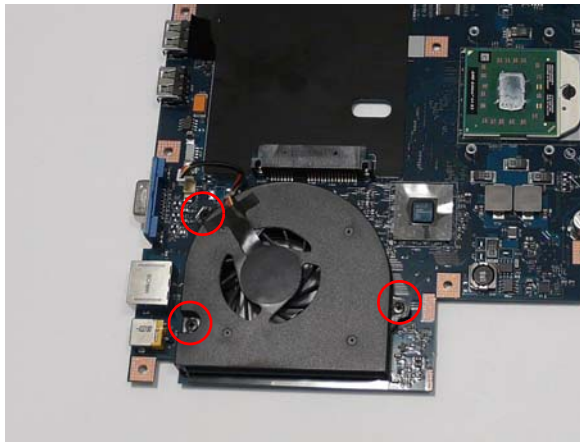

3. Remove the three securing screws from the Fan Module.



Step	Size	Quantity	Screw Type
CPU Fan	M2*3	3	

---

4. Lift the CPU Fan clear of the Mainboard as shown.



---

## Removing the CPU

**IMPORTANT:** The pins on the underside of the CPU are very delicate. If they are damaged, the CPU may malfunction. Place the CPU on a clean, dry surface when it is not installed.

1. See “Removing the Thermal Module” on page 74.
2. Using a flat-bladed screw driver, rotate the CPU locking screw 180° counter-clockwise as shown.



3. Lift the CPU clear of the socket as shown.

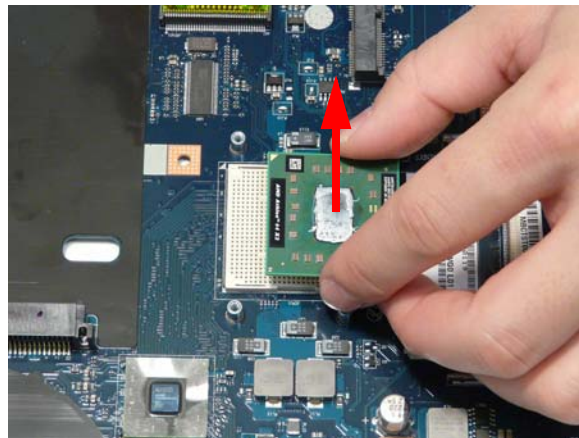

---

# LCD Module Disassembly Process

## LCD Module Disassembly Flowchart

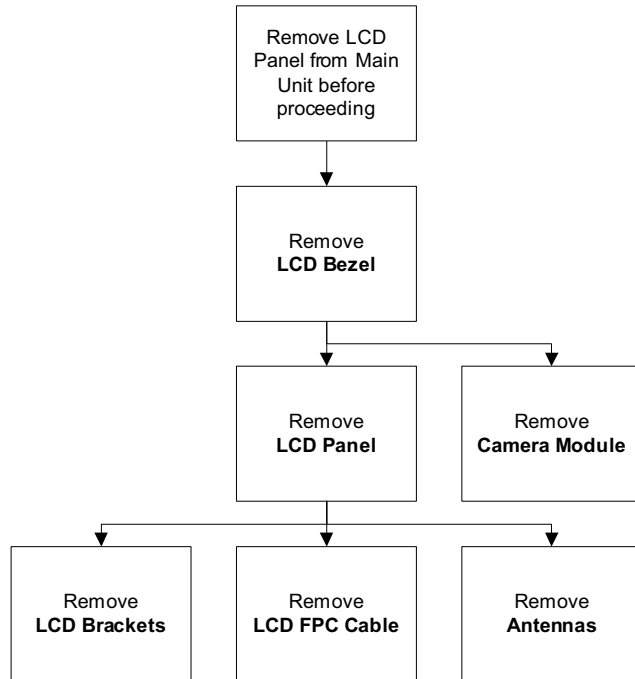

### Screw List

Step	Screw	Quantity	Part No.
LCD Bezel	M2.5*6	4	86.N2802.002
LCD Panel	M2.5*6	2	86.N2802.002
LCD Brackets	M2*3	6	86.N2802.004

# Removing the LCD Bezel

1. See "Removing the LCD Module" on page 57.
2. Remove the two upper and two lower bezel screw caps and screws.



Step	Size	Quantity	Screw Type
LCD Bezel	M2.5*6	4	

3. Starting from the bottom edge of the bezel, pry the bezel upwards and away from the panel. Work along the right side toward the top of the bezel, prying the covers apart. Continue along the top edge and down the left side to remove the bezel.

**NOTE:** If necessary, use a pry to lift up the outside edges of the bezel.



---

## Removing the Camera Module

1. See "Removing the LCD Bezel" on page 80.
2. Locate the Camera Module at the top of the LCD Module and disconnect the camera cable.



3. Remove the Camera from the module.

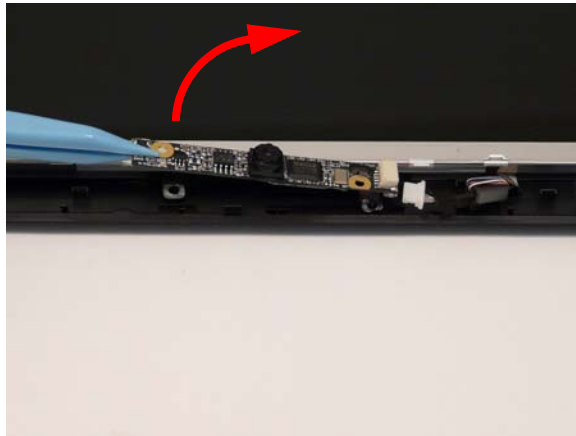

# Removing the LCD Panel

1. See "Removing the Camera Module" on page 81.
2. Remove the two securing screws from the LCD Panel.



Step	Size	Quantity	Screw Type
LCD Panel	M2.5*6	2	

3. Remove the adhesive strip holding the cables in place.

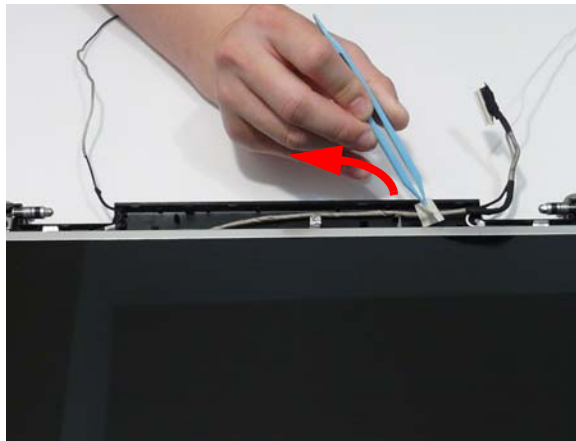

4. Remove the Camera cable cluster from the LCD Module as shown.

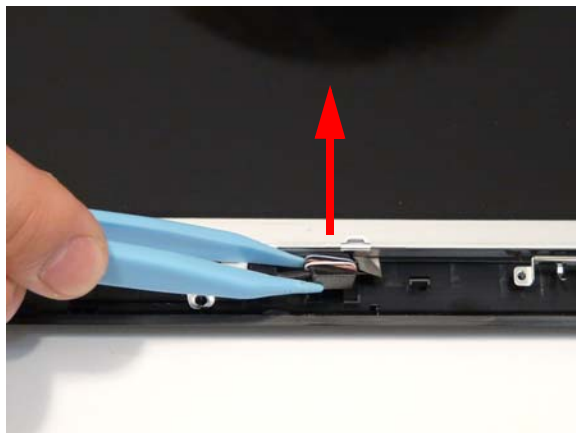



---

5. Lift the LCD Panel clear of the module.



# Removing the LCD Brackets and FPC Cable

- 1. See "Removing the LCD Panel" on page 82.
- 2. Remove the six securing screws (three on each side) from the LCD Panel brackets.

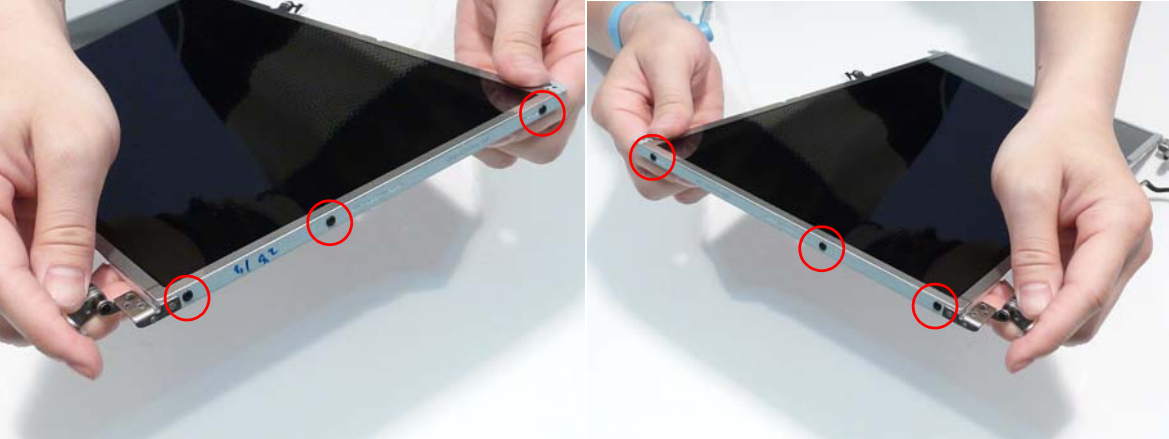

Step	Size	Quantity	Screw Type
LCD Brackets	M2*3	6	

- 3. Remove the LCD brackets by pulling away from the LCD Panel.



4. Turn the LCD panel over to expose the rear. Lift the adhesive protector and disconnect the cable from the LCD Panel.

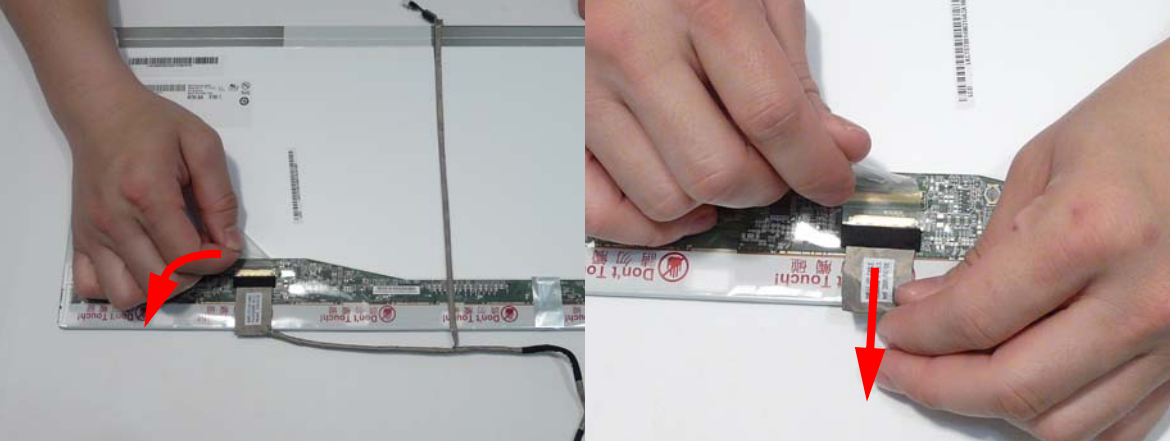

5. Lift the cable as shown to disengage the adhesive strip securing it in place.

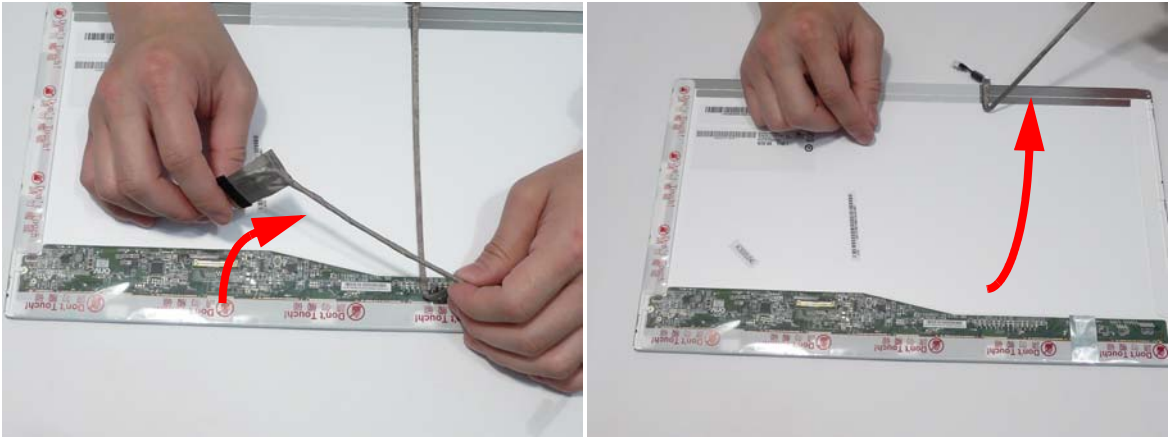

6. Lift the FPC cable to disengage the remaining adhesive and remove the cable from the panel.

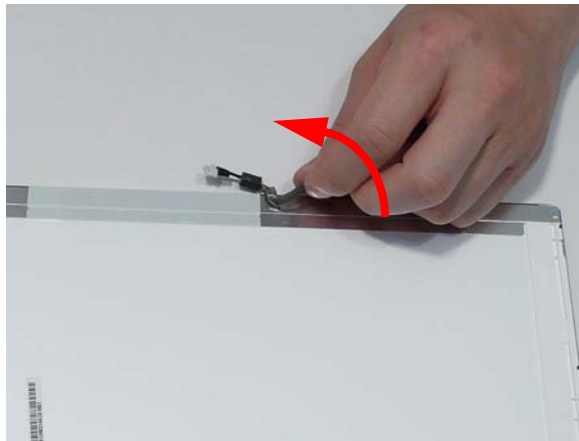

## Removing the Antennas

1. See "Removing the LCD Panel" on page 82.
2. Remove the adhesive strips holding the left antenna cable in place. Ensure the cable is free from obstructions.



3. Remove the cable from the cable channel. Ensure that the cable is free from all cable clips and adhesive strips.

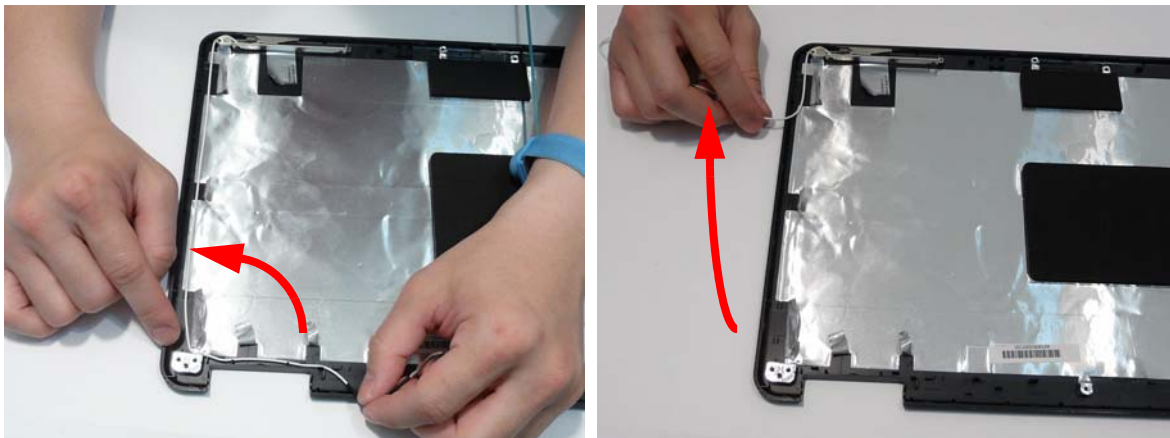

4. Remove the adhesive tape securing the left Antenna to the LCD Module.



5. Lift the left Antenna clear of the cover.

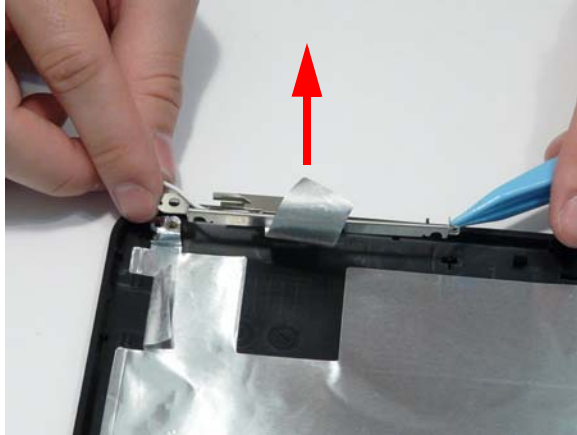

6. Remove the adhesive strips holding the right antenna cable in place. Ensure the cable is free from obstructions.

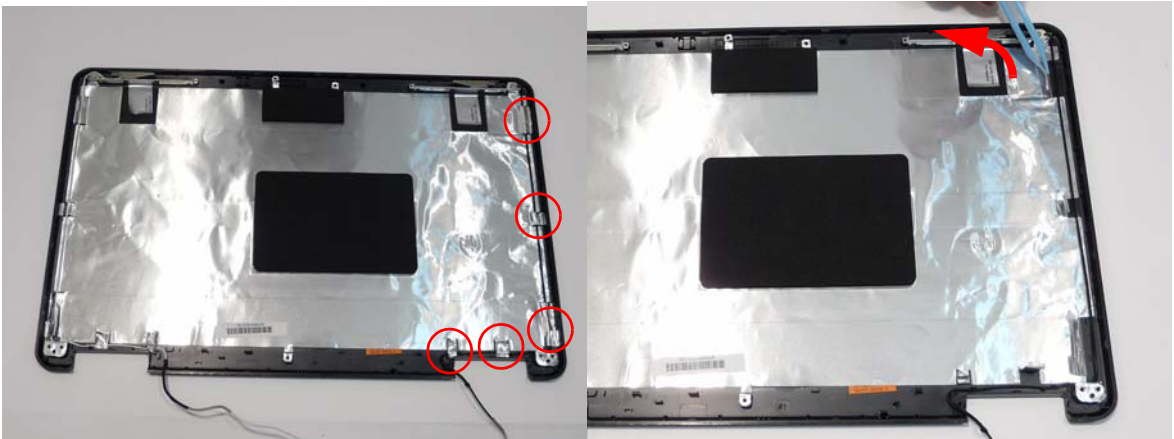

7. Remove the cable from the cable channel. Ensure that the cable is free from all cable clips and adhesive strips.

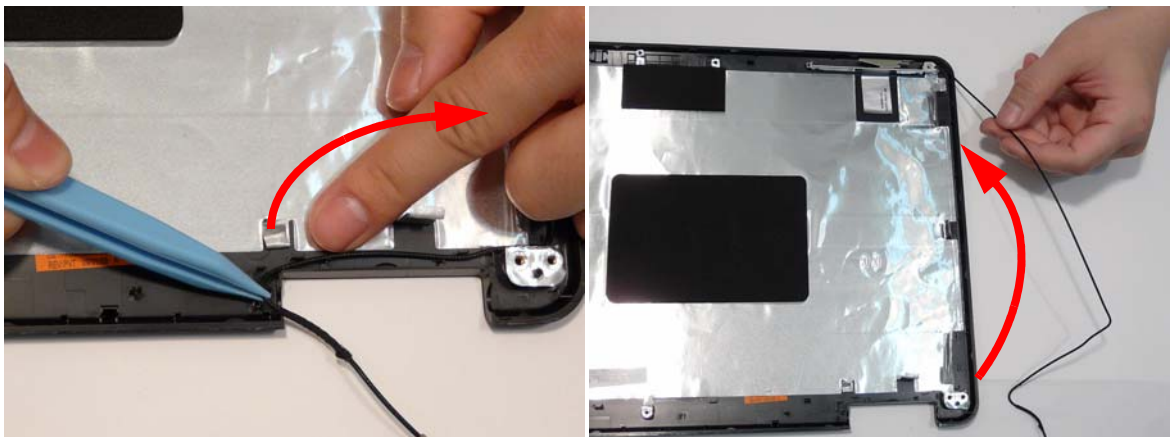

---

8. Remove the adhesive tape securing the right Antenna to the LCD Module.



9. Lift the right Antenna clear of the cover.

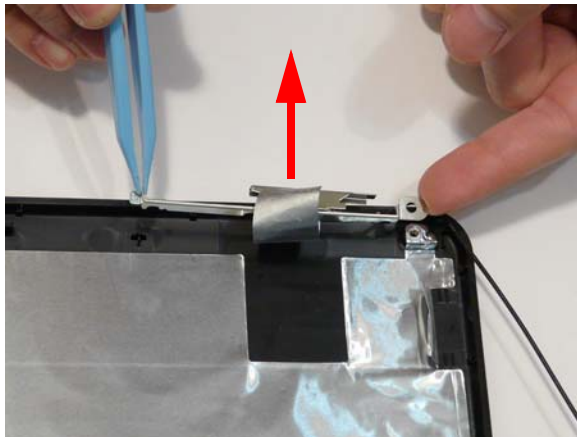



# LCD Module Reassembly Procedure

## Replacing the Antennas

1. Replace the right Antenna as shown. Ensure that the locating pins on the Antenna are correctly seated.

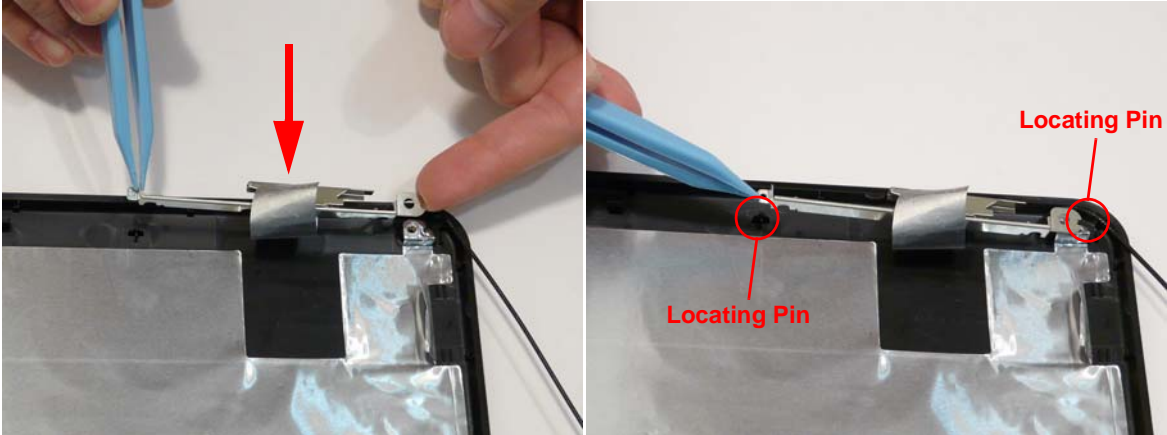

2. Replace the adhesive strip to secure the Antenna in place.
3. Run the cable down the side of the LCD Module using all available clips and adhesive.

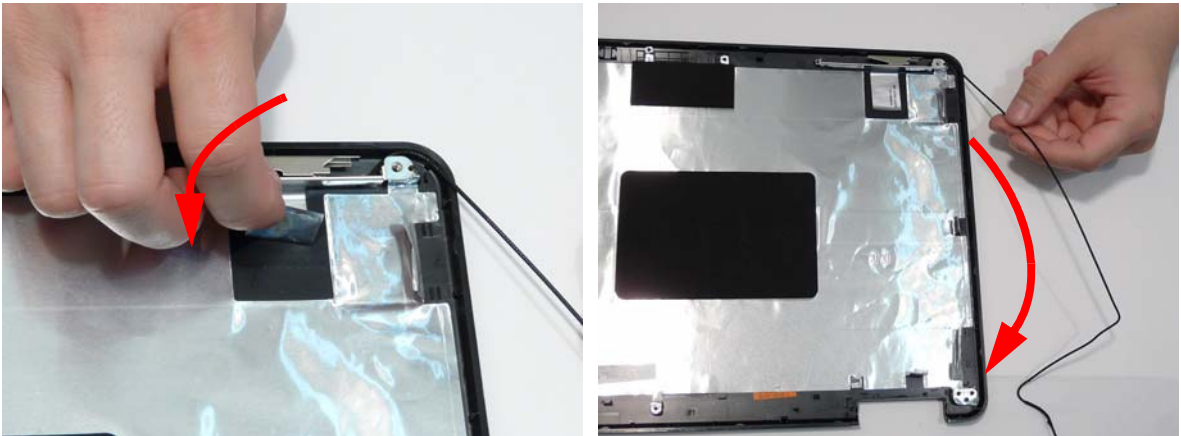

4. Run the cable along the cable channel as shown, using all available cable clips.

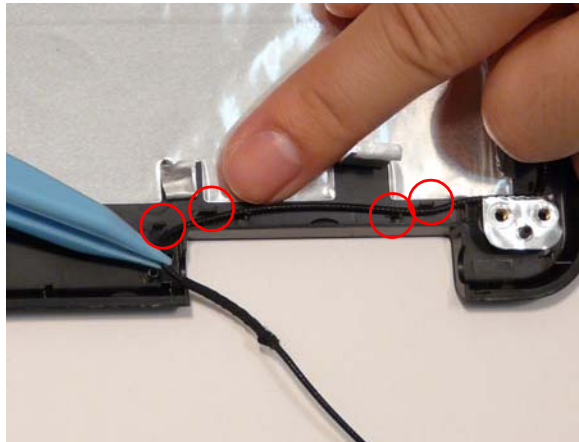

5. Replace the left Antenna as shown. Ensure that the locating pins on the Antenna are correctly seated.

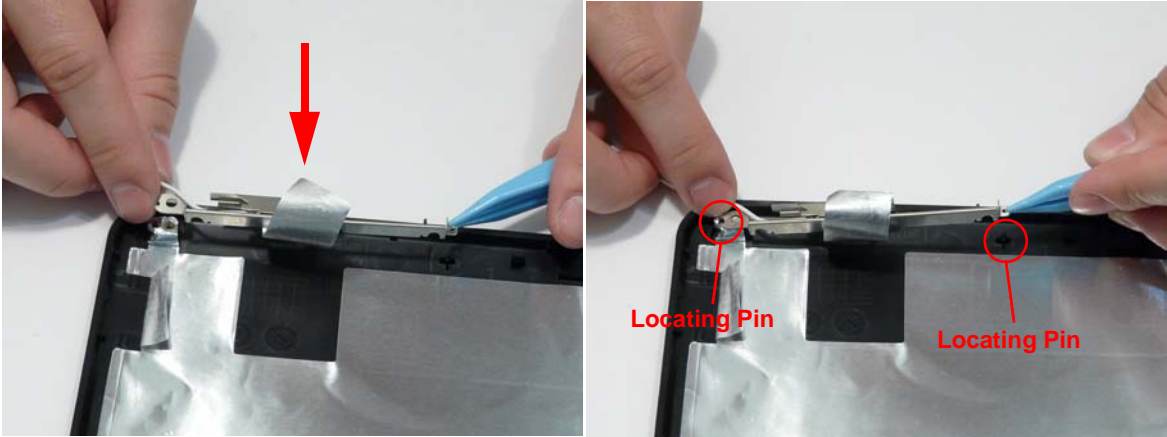

6. Replace the adhesive strip to secure the Antenna in place.

7. Run the cable down the side of the LCD Module using all available clips and adhesive.

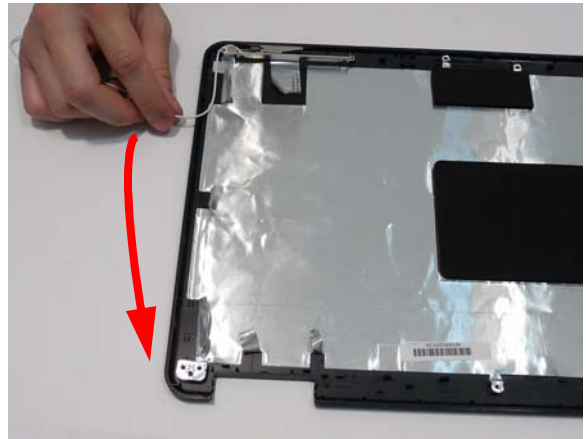

8. Run the cable along the cable channel as shown, using all available cable clips and adhesive.





---

9. The Antennas and cables appear as shown when correctly installed.



# Replacing the LCD Panel

1. Connect the LCD cable to the panel connector as shown.
2. Press down the adhesive strip to secure the cable in place.



3. Run the cable along the back of the panel and press down as indicated to secure the cable in place.
4. Run the cable across the back of the panel as shown and press down as indicated to secure the cable in place.

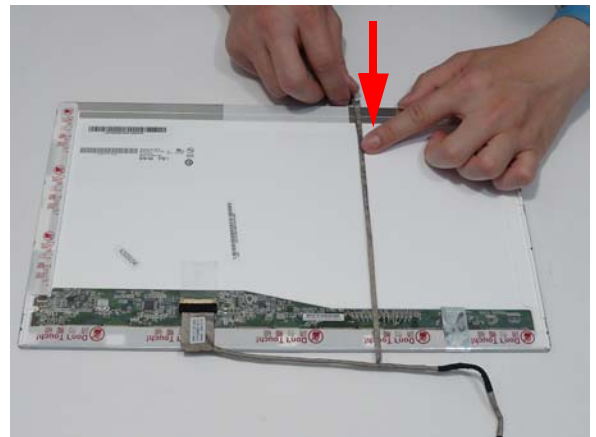
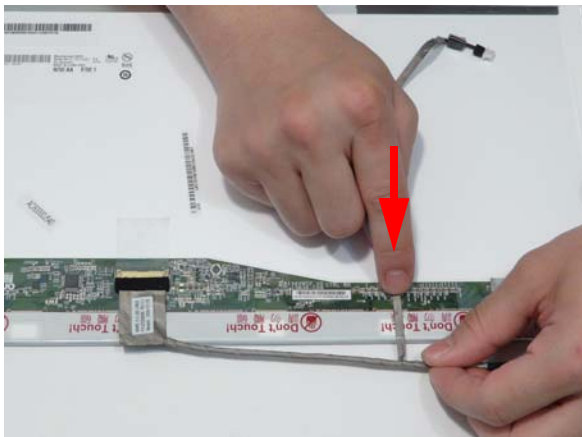

**IMPORTANT:** Ensure that the LCD cable runs between the green callouts to avoid trapping when the panel is replaced in the LCD Module.

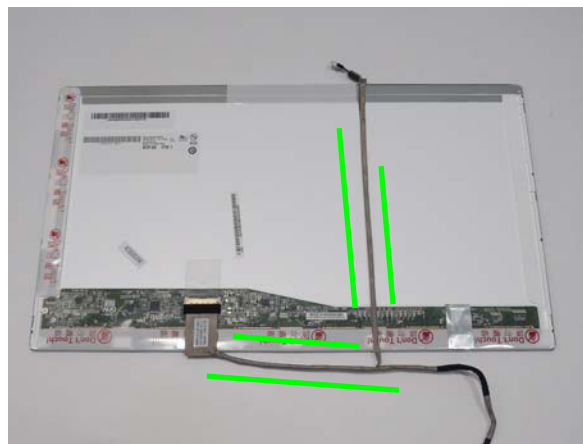

- 
5. Align the LCD brackets with the screw holes on the panel. Replace the six screws (three on each side) in the brackets as shown.



6. Place the LCD Panel in the LCD Module, top edge first, and secure the LCD cable with adhesive tape.

**IMPORTANT:** Ensure that the LCD power cable passes through the hinge well and is not trapped under the panel.

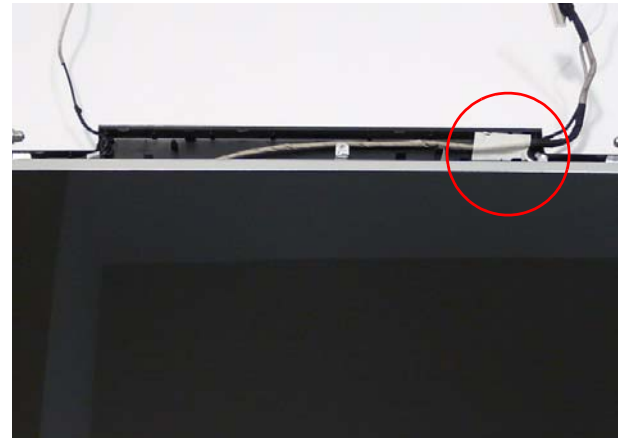

7. Replace the Camera cable cluster in the LCD Module.



8. Secure the LCD module with the two securing screws.



## Replacing the Camera Module

1. Place the camera in the LCD Module.

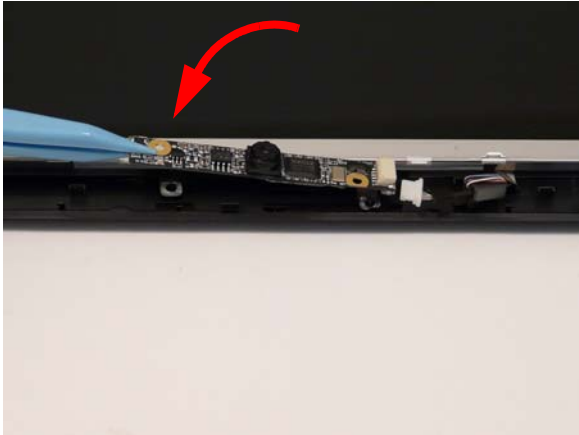

2. Connect the cable to the camera module.



---

## Replacing the LCD Bezel

1. Replace the bezel and press down until there are no gaps between the bezel and the LCD Module.

**IMPORTANT:** Ensure that the LCD cables pass through the hinge wells and are not trapped by the bezel.



---

2. Replace the four screws and screw caps provided.





---

# Main Module Reassembly Procedure

## Replacing the CPU

**IMPORTANT:** The CPU has a Pin1 locator that must be positioned corresponding to the marker on the CPU socket.

1. Place the CPU into the CPU socket as shown, taking note of the Pin1 locator.

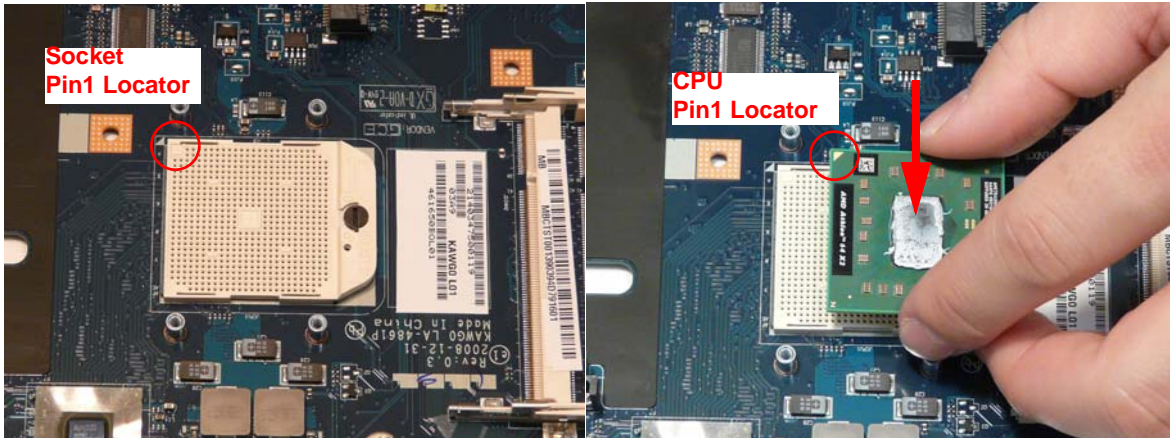

2. Using a flat-bladed screw driver, rotate the CPU locking screw 180° clockwise to secure the CPU in place.



---

## Replacing the CPU Fan

1. Align the screw holes on the CPU Fan and Mainboard and replace the Fan.

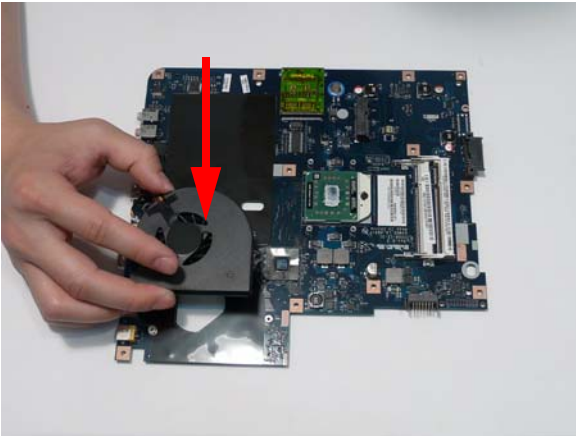

2. Replace the three screws to secure the Fan to the Mainboard.

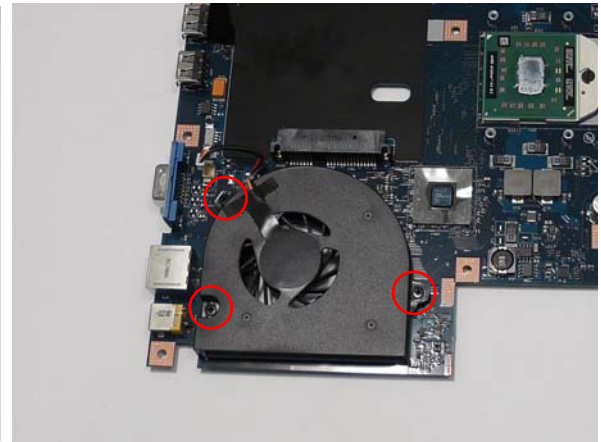

3. Connect the Fan power cable to the Mainboard connector.



## Replacing the Thermal Module

**IMPORTANT:** Apply a suitable thermal grease and ensure all heat pads are in place before replacing the Thermal Module.

The following thermal grease types are approved for use:

- Silmore GP50
- Honeywell
- Jet Motor 7762

The following thermal pads are approved for use:

- Eapus XR-PE

1. Remove all traces of thermal grease from the CPU using a lint-free cloth or cotton swab and Isopropyl Alcohol, Acetone, or other approved cleaning agent.
2. Apply a small amount of thermal grease to the centre of the CPU—there is no need to spread the grease manually, the force used during the installation of the Thermal Module is sufficient.



- Align the screw holes on the Thermal Module and Mainboard then replace the module. Keep the module as level as possible to spread the thermal grease evenly.
- Replace the four securing screws (in numerical order from screw 1 to screw 4) to secure the Thermal Module in place.

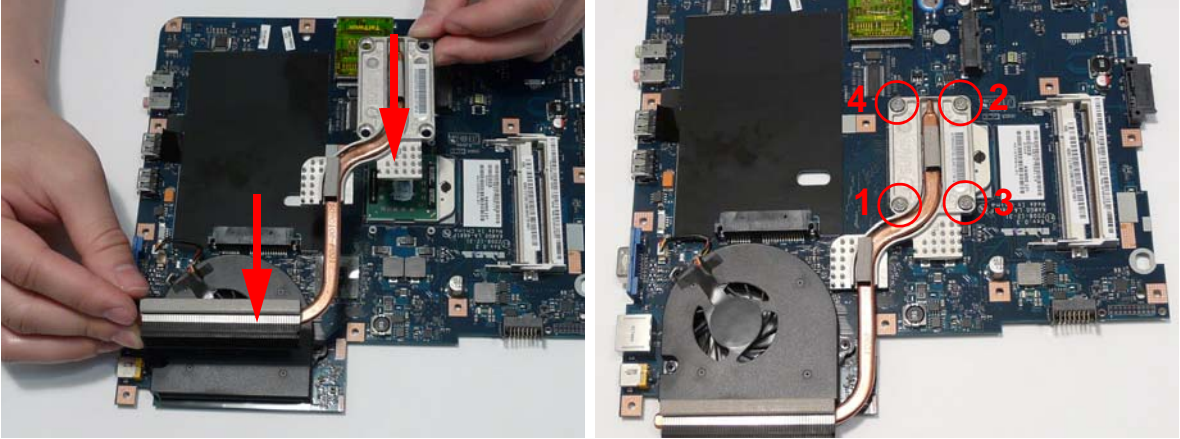

## Replacing the Mainboard

- Ensure that the Mainboard is face up (the CPU is not visible). Place the Mainboard in the chassis, left edge first (1), then rotate it downward into position (2).

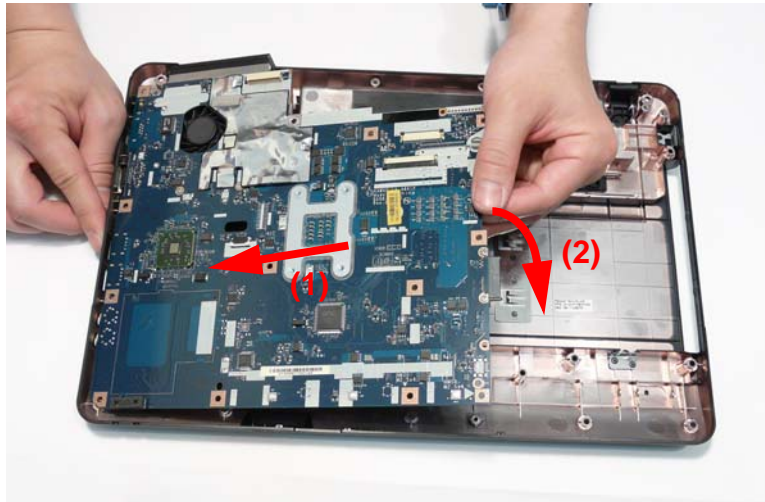

**NOTE:** Ensure the I/O ports are positioned correctly through the casing.

- Replace the single securing screw in the mainboard.



## Replacing the TouchPad Bracket

1. Replace the TouchPad bracket top edge first to engage the securing clips.
2. Press the bracket down to engage the securing clips.

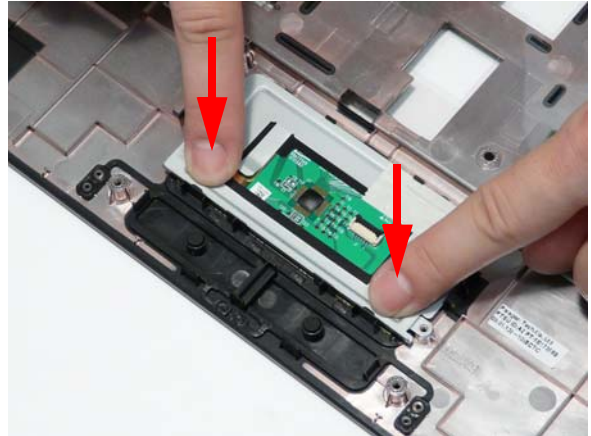
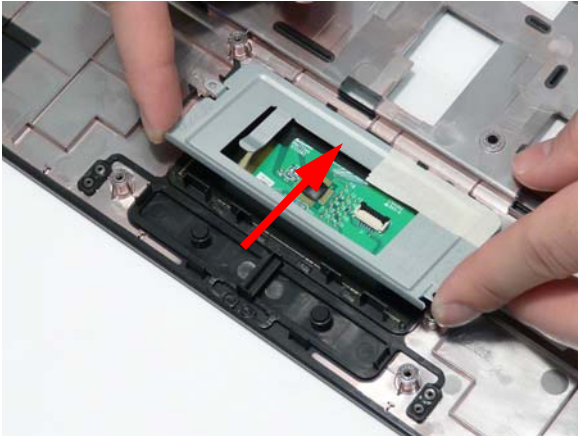

3. Replace the two screws to secure the TouchPad Bracket to the Upper Cover.

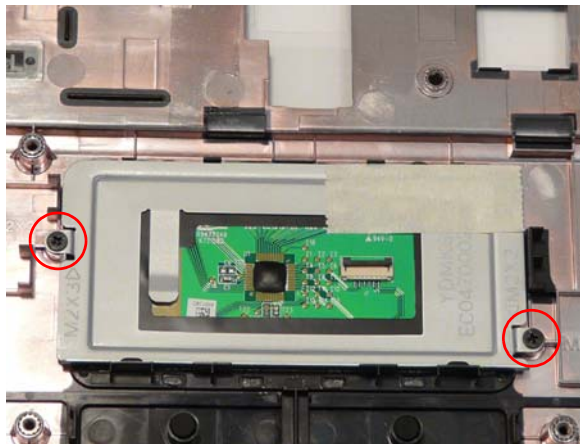

4. Replace the TouchPad FFC and close the locking latch on the connector.

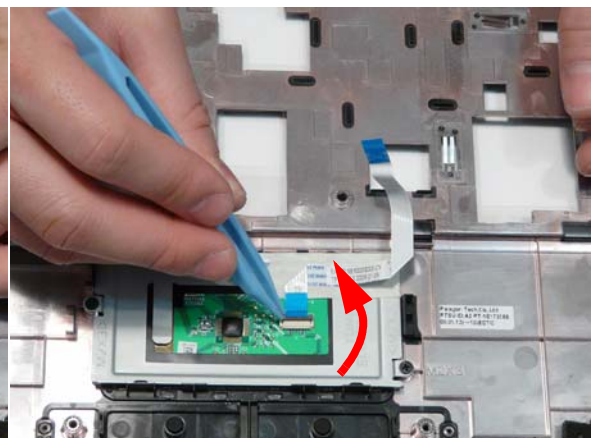
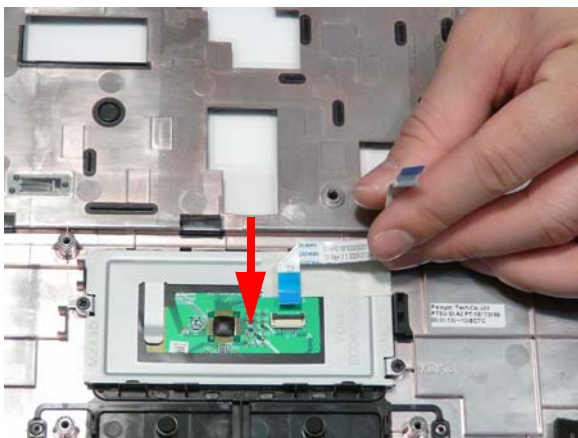

5. Replace the FFC and press down as indicated to secure it to the Upper Cover.

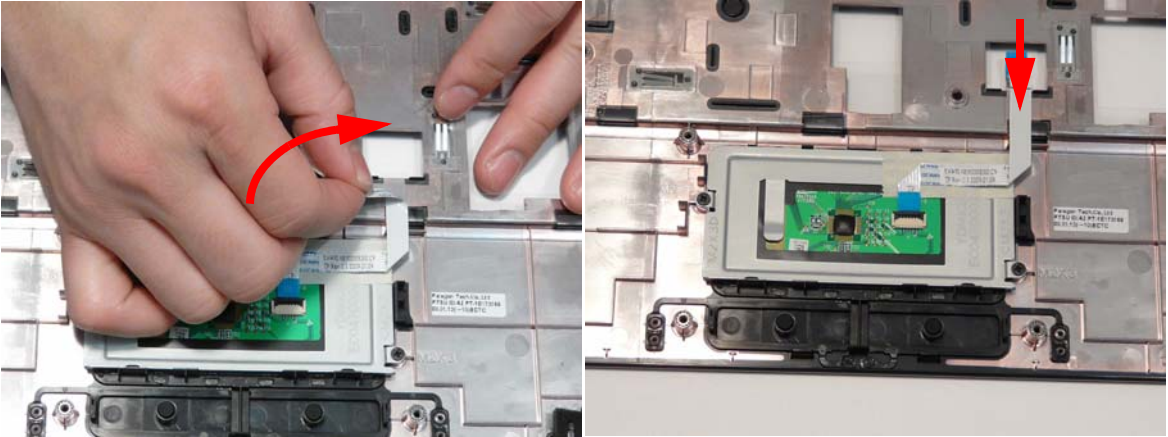



# Replacing the Right Speaker Module

1. Place the module left side first on the Upper Cover as shown. Ensure that the left side of the module is seated correctly in the securing clip.
2. Replace the single screw to secure the module in place.



3. Pass the cable through the Upper Cover as shown.
4. Turn the Upper Cover over and run the cable along the cable channel using all available cable clips.

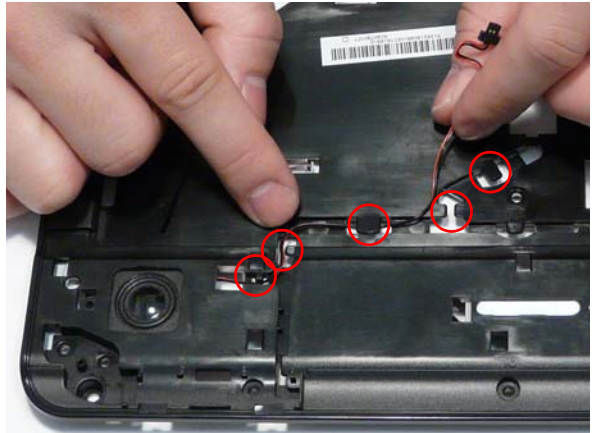
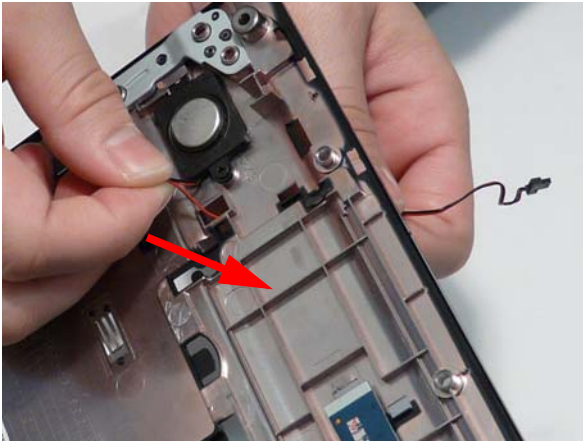

5. The cable runs as shown when correctly installed.



# Replacing the Left Speaker Module

1. Place the module right side first on the Upper Cover as shown. Ensure that the right side of the module is seated correctly in the securing clip.
2. Replace the single screw to secure the module in place.

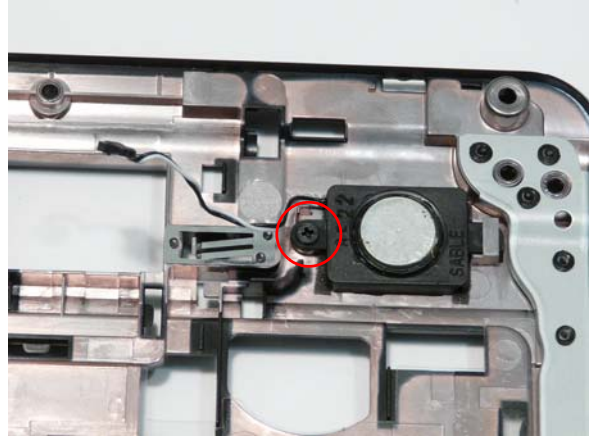
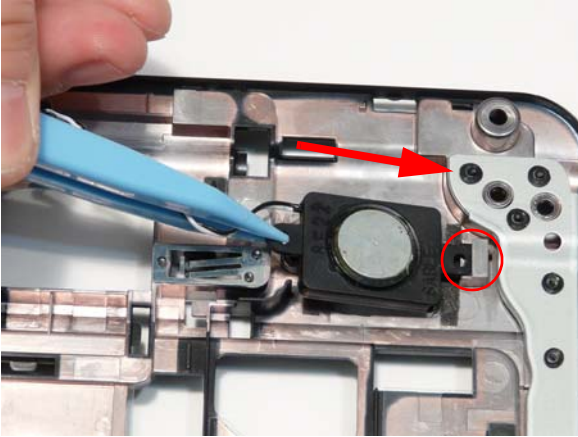

3. Run the cable along the cable channel using all available cable clips.

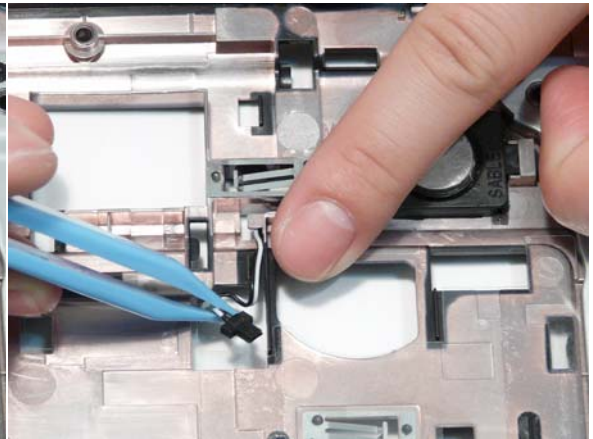
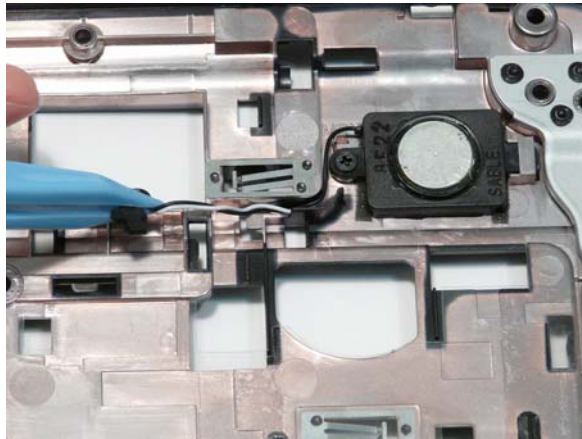

4. Secure the cable in place with adhesive tape.
5. The cable runs as shown when correctly installed.

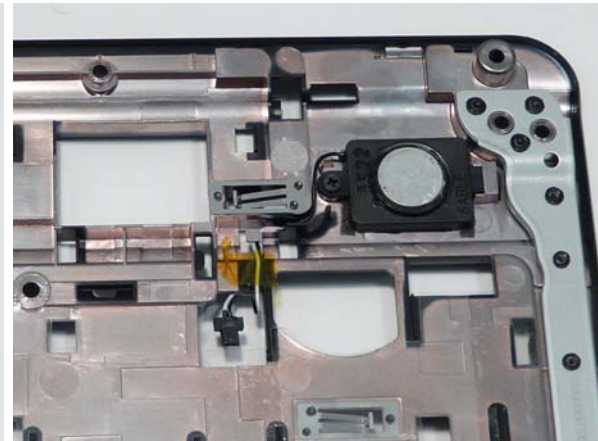
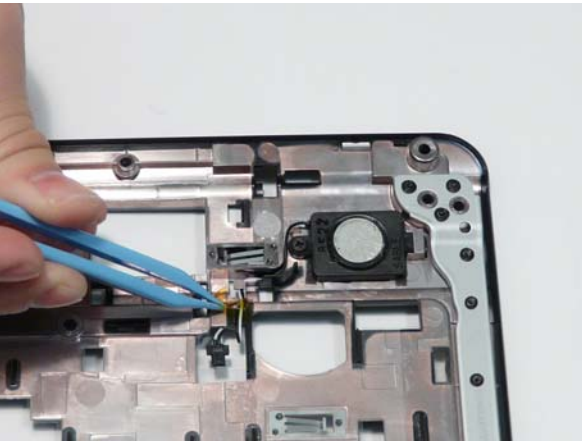



## Replacing the Power Board

1. Slide the Power Board in to the Upper Cover front edge first to engage the securing clip.

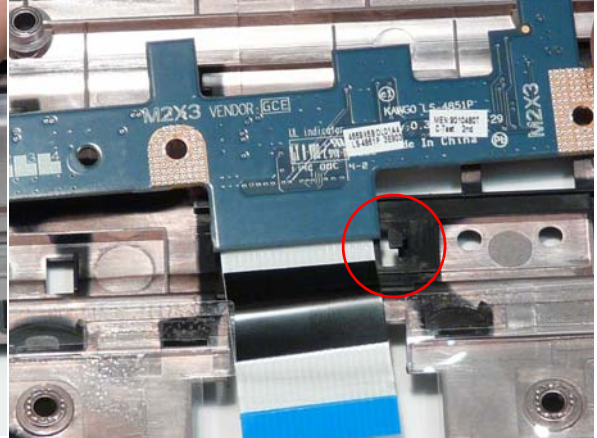
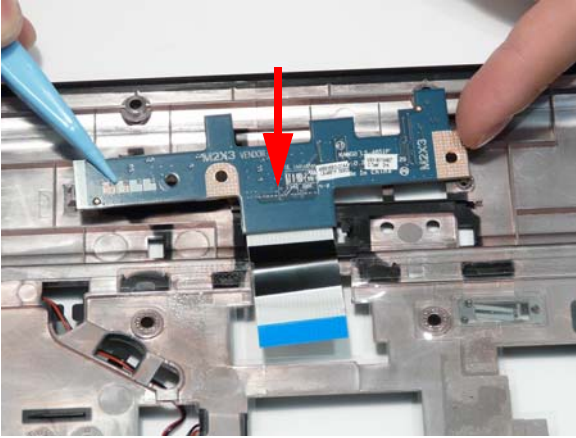

2. Press the board down to locate the securing pin.

3. Replace the two screws to secure the board to the Upper Cover.

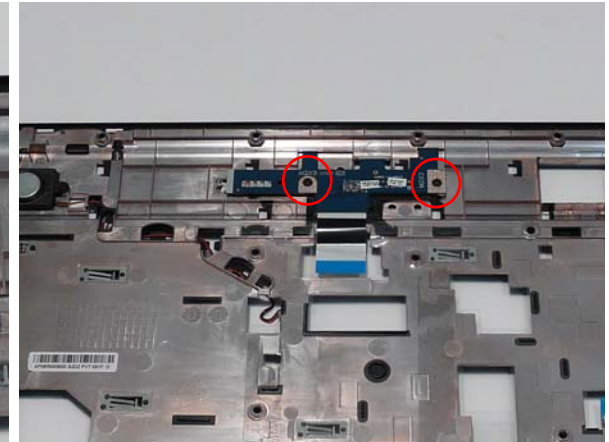
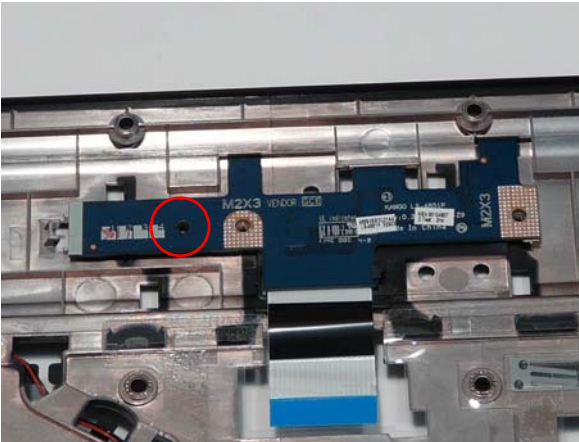

## Replacing the Upper Cover

1. Place the Upper Cover on the Lower Cover as shown.



2. Press down around the edges to secure it in place.



3. Replace the nine screws in the Upper Cover as shown.

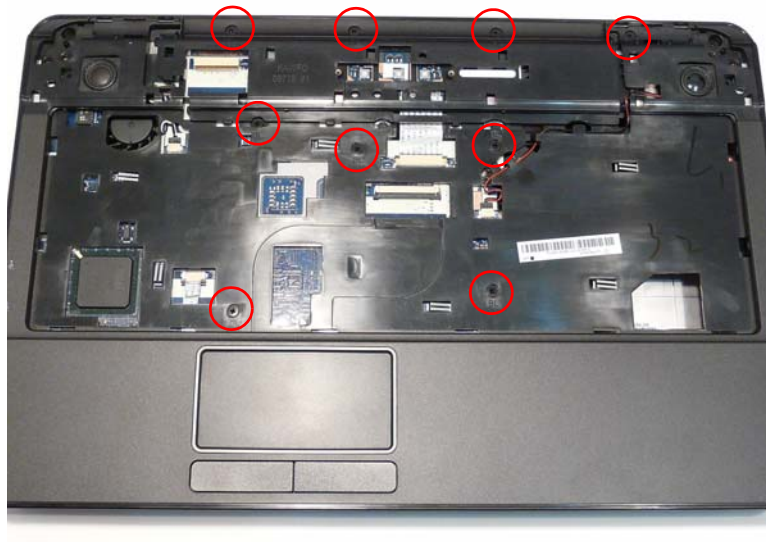

4. Replace the three screw caps as shown.

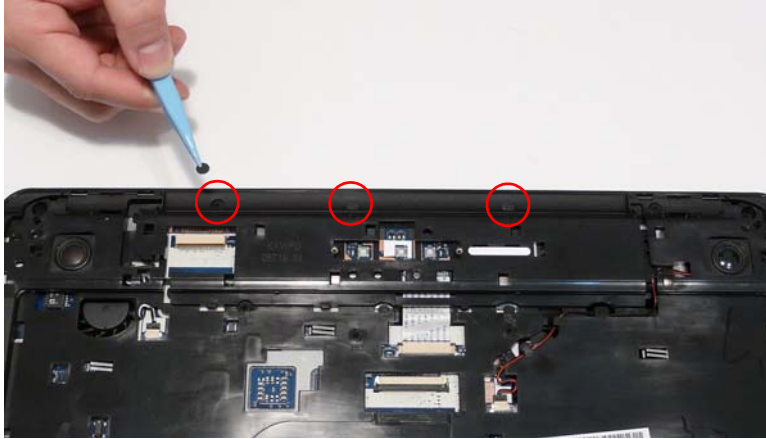

5. Connect the following cables to the Mainboard.

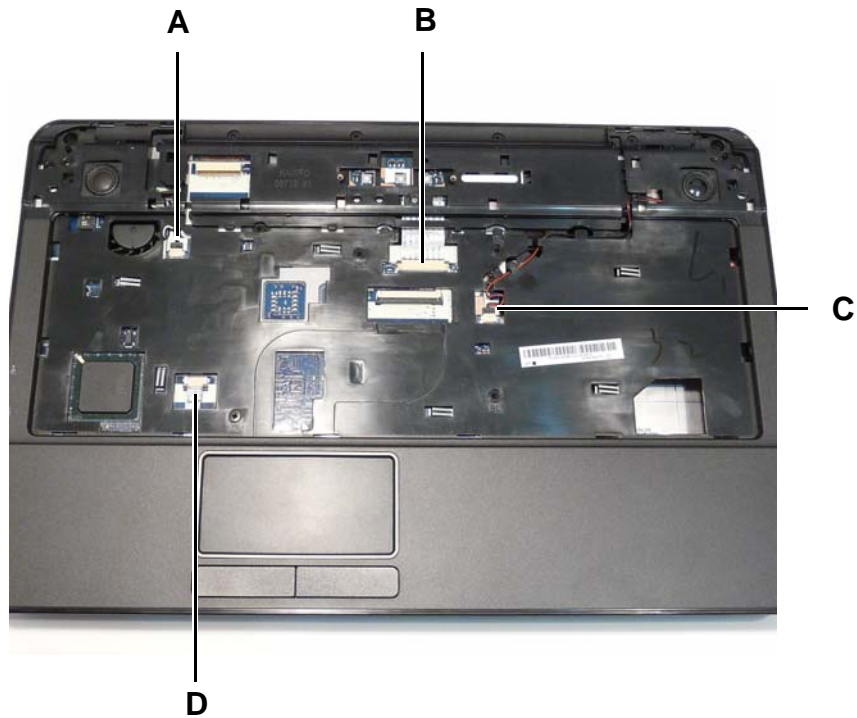



6. Connect A as shown.

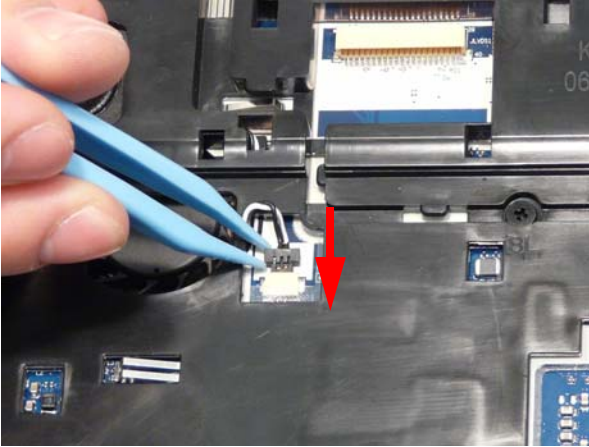

7. Connect C as shown.

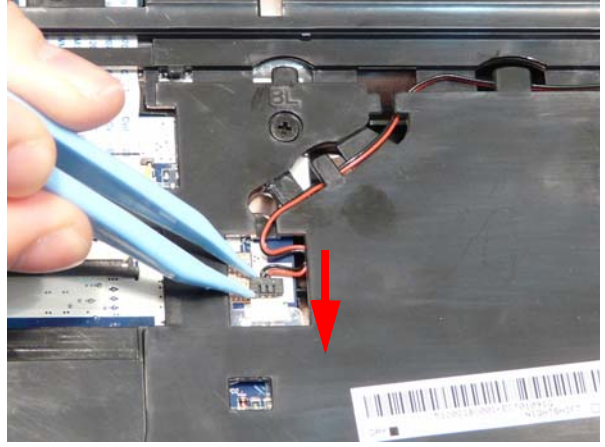

8. Connect B and close the locking latch to secure the cable in place.

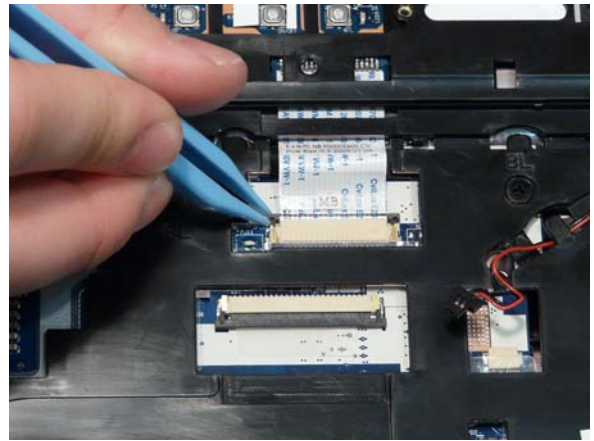
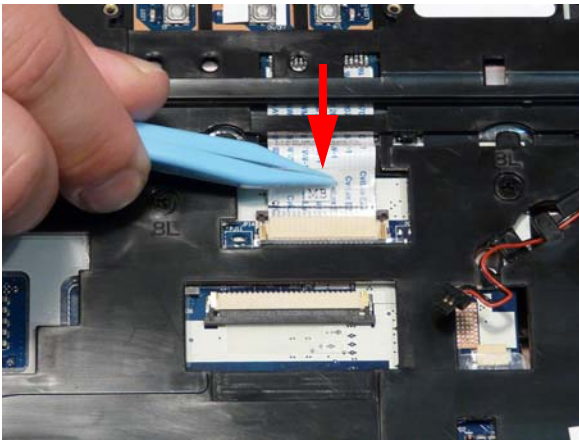

9. Connect D and close the locking latch to secure the cable in place.

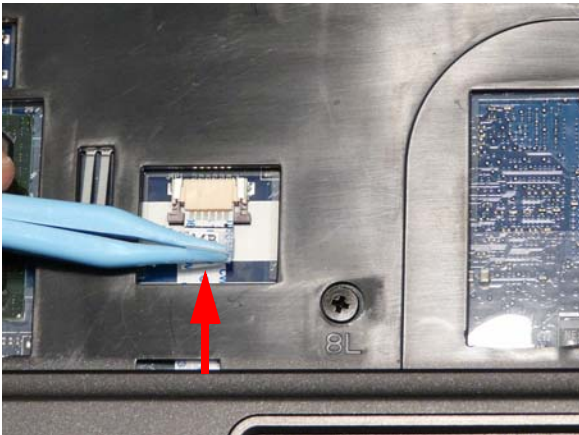

10. Turn the computer over and replace the eleven screws as shown.

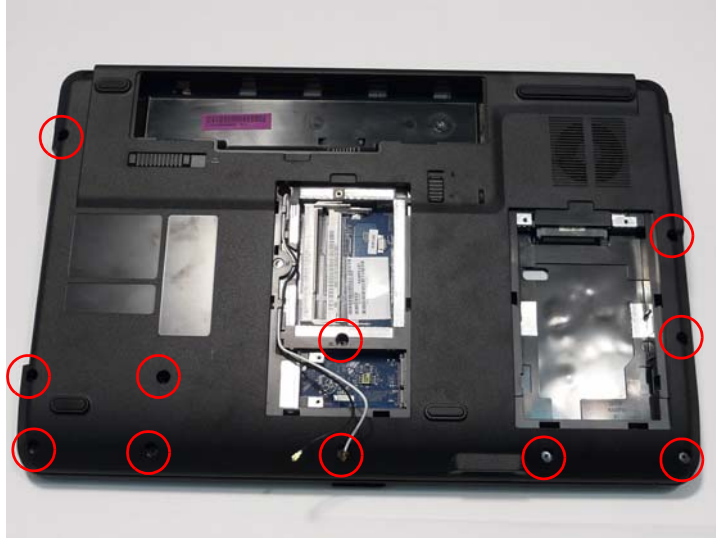

## Replacing the LCD Module

1. Align the screw holes on the LCD Module and Upper Cover and replace the LCD Module.
2. The left and right screw covers are shaped differently. Ensure that the correct cover is used.

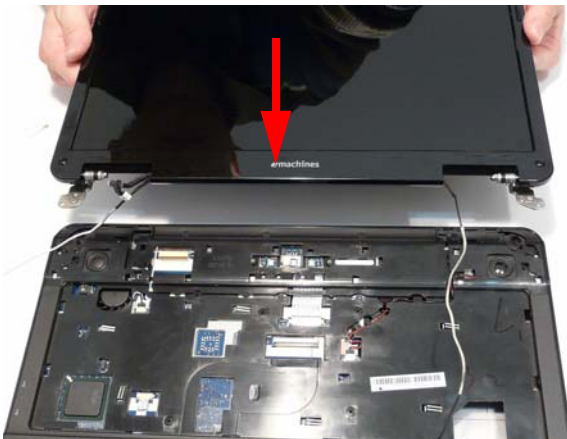

3. Replace the left screw cover as shown. Ensure that the securing tab on the rear of the cover is seated correctly in the Upper Cover.

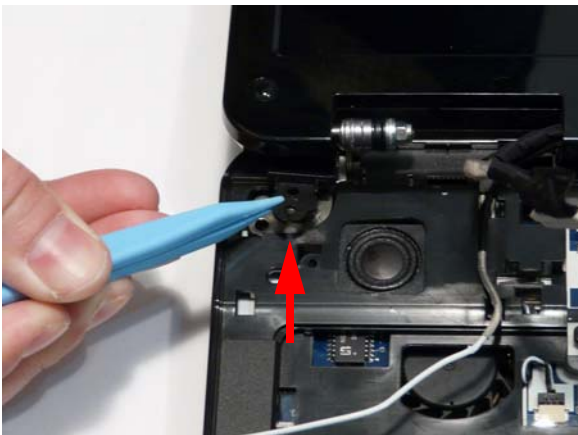

4. Replace the right screw cover as shown. Ensure that the securing tab on the rear of the cover is seated correctly in the Upper Cover.

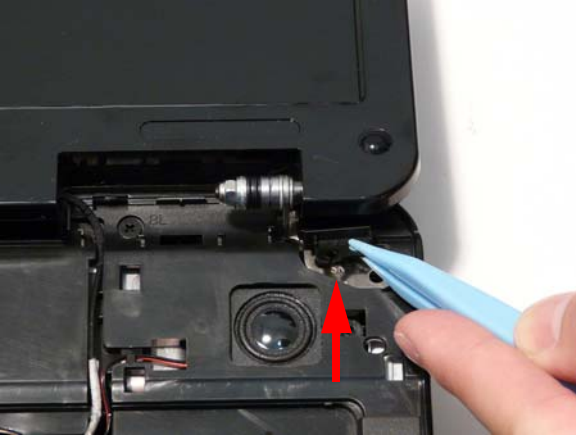

5. Replace the four screws securing the LCD Module to the Upper Cover.



6. Ensure that the Hinge Covers are replaced correctly. Identify the rear edge of the covers by the two securing clips.

7. Align the left Hinge Cover as shown and press down to replace the cover.



8. Repeat the process for the right side Hinge Cover.



9. Run the black Antenna cable along the cable channel as shown using all available retaining clips.

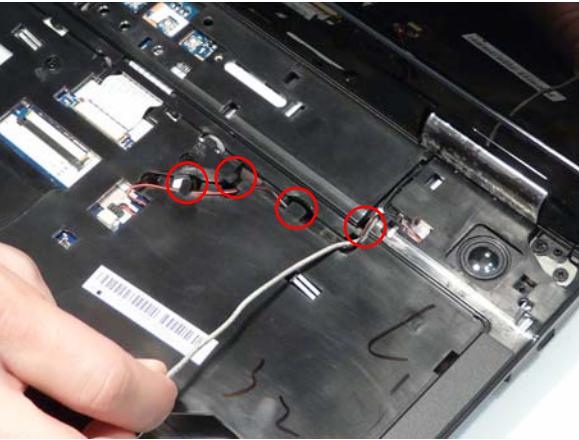

10. Replace the adhesive strip to secure the cable in place.

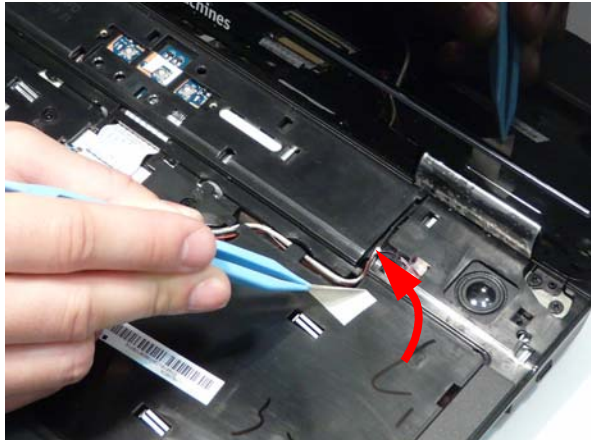

11. Run the white Antenna cable along the cable channel as shown using all available retaining clips.

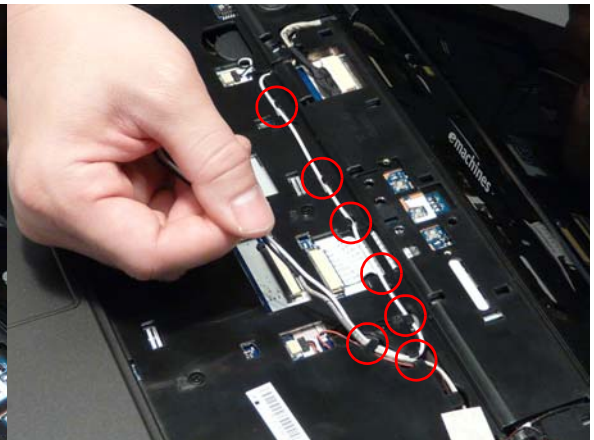
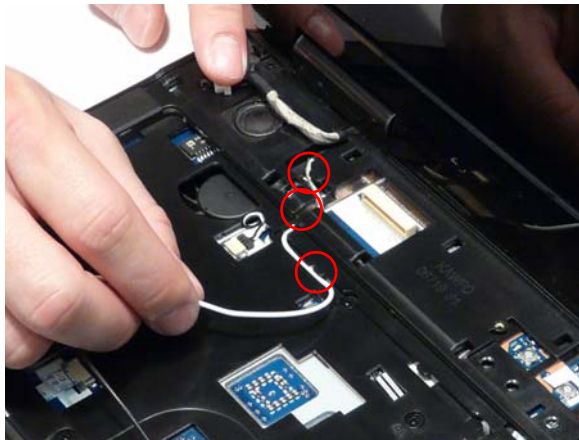

12. Run the LCD cable along the cable channel using all available cable clips.

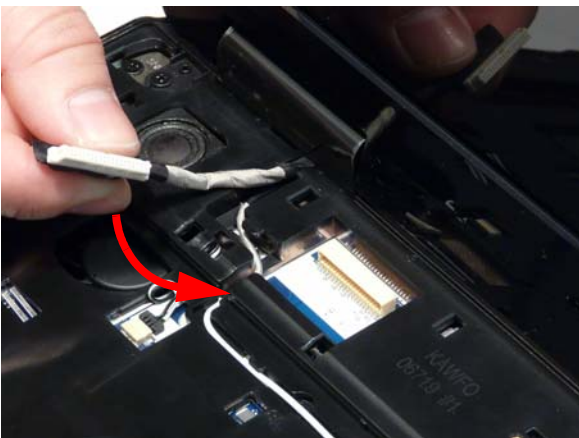

13. Connect the LCD cable to the Mainboard as shown.

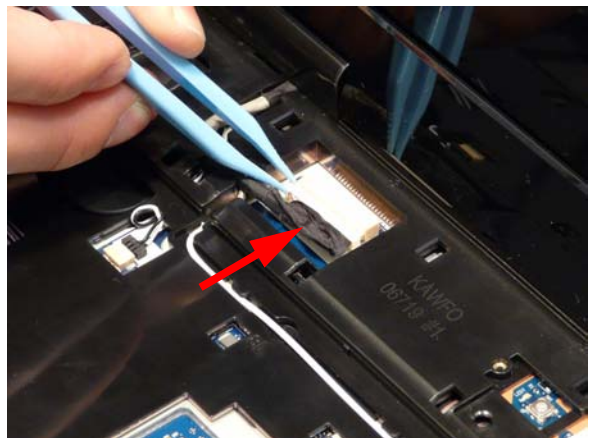

14. Stand the computer on the LCD Panel and pass the Antenna cables through the chassis.



15. The Upper Cover appears as shown when the Antenna and LCD cables are correctly installed.

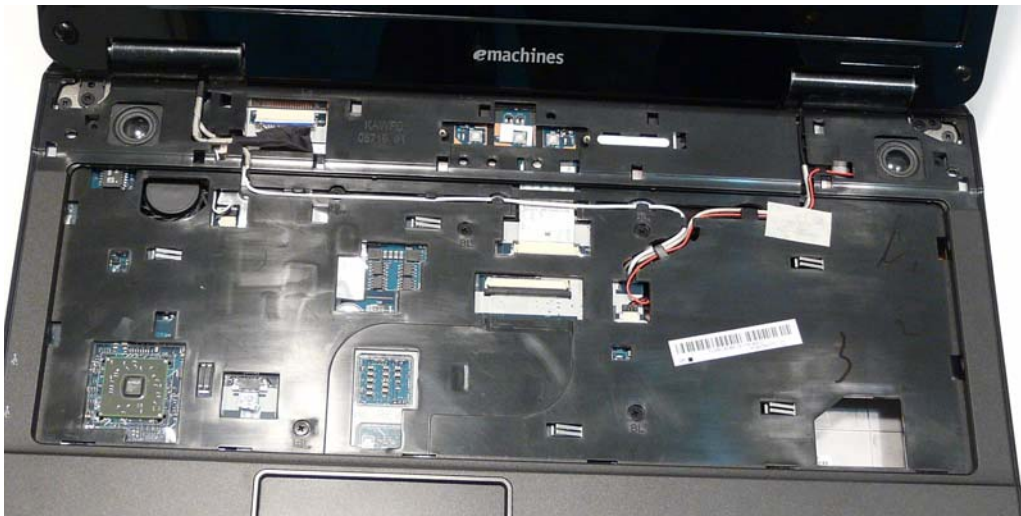

16. Turn the computer over. Run the Antenna cables along the cable channel as shown, using all available cable clips.

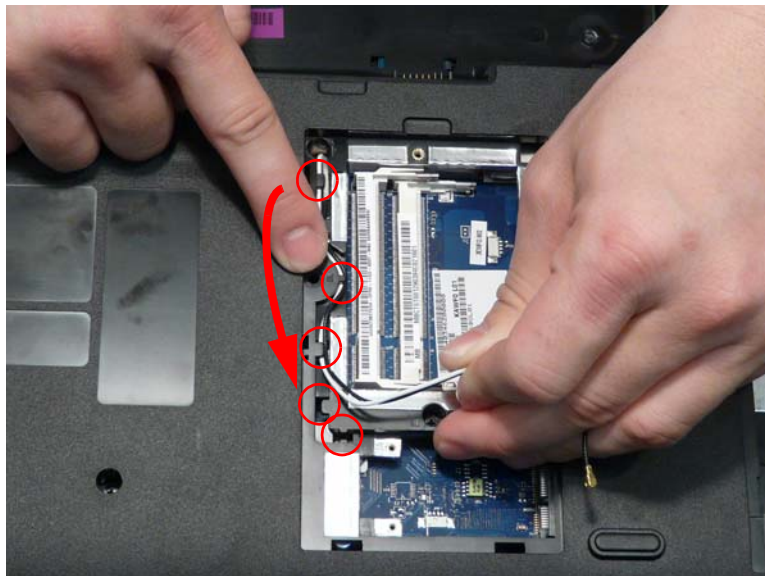

---

17. Replace the two screws securing the LCD Module to the Lower Cover.





## Replacing the Keyboard

1. Connect the Keyboard FFC to the Mainboard and close the locking latch to secure the cable in place.

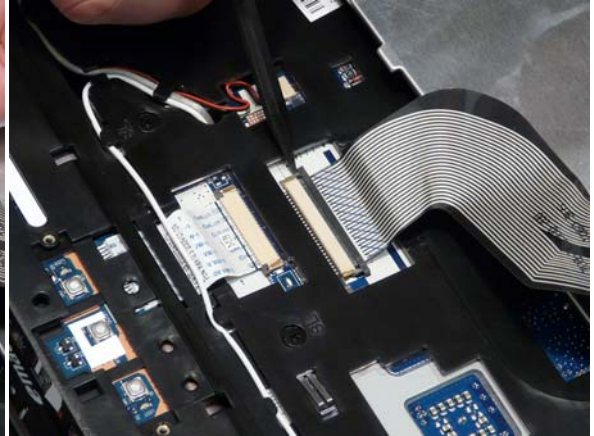
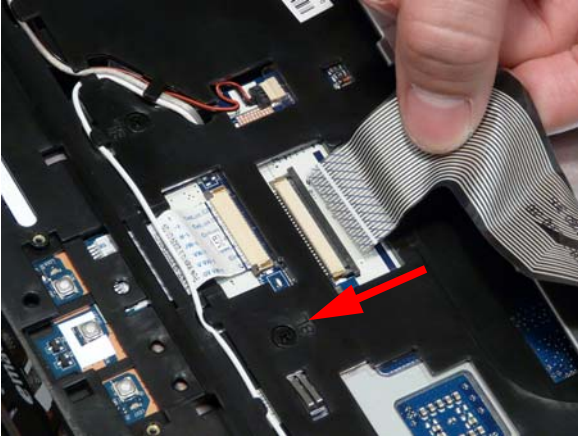

2. Turn the Keyboard over and insert it front edge first into the chassis.
3. Press down as indicated to secure the Keyboard in place.

**NOTE:** Ensure that the six locating tabs are correctly seated.



---

## Replacing the Switch Cover

1. Place the Switch Cover left side first on to the Upper Cover.



2. Press down as indicated to snap the Switch Cover into place.



## Replacing the Hard Disk Drive Module

1. Place the HDD in the HDD carrier.
2. Replace the four screws (two each side) to secure the carrier.

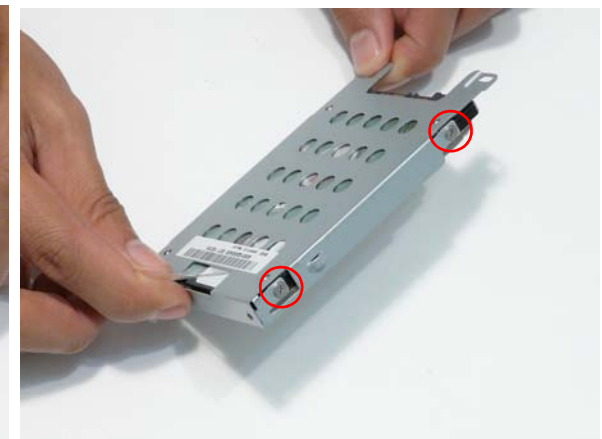
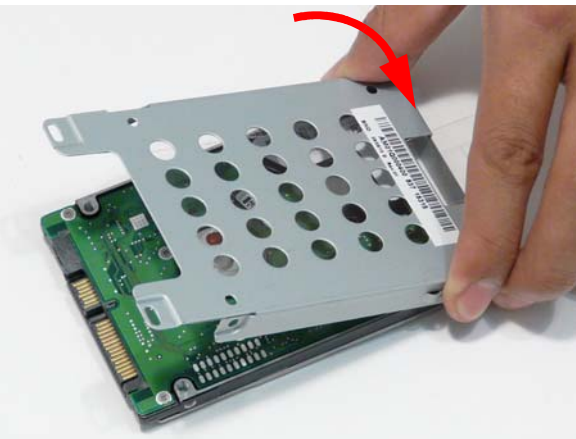



3. Insert the HDD, as indicated and lower it into place.



4. Slide the HDD in the direction of the arrow to connect the interface.

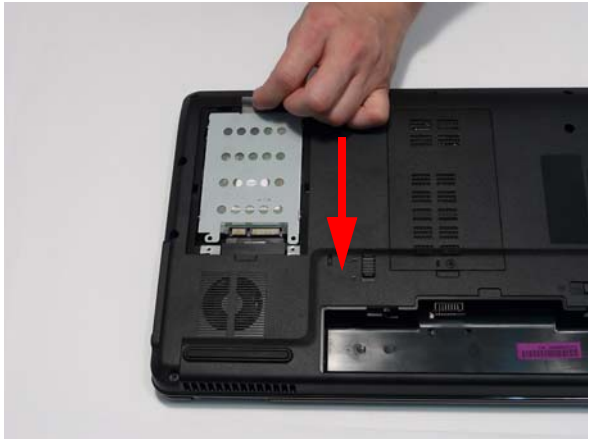

## Replacing the WLAN Module

1. Insert the WLAN Module into the WLAN socket.
2. Replace the two screws to secure the module.



3. Connect the two Antenna cables to the module.  
**NOTE:** The black cable connects to the upper terminal (MAIN) and the white cable to the lower terminal (MAIN).
4. After connecting the cables to the terminals, secure the cables in place with adhesive tape to avoid trapping.

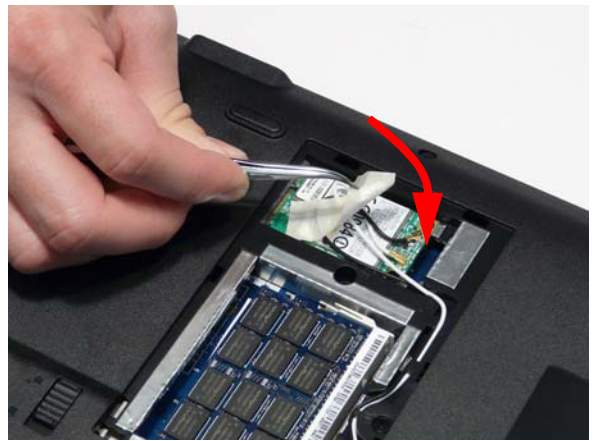

## Replacing the DIMM Modules

1. Insert the DIMM Module in place.
2. Press down to lock the DIMM module in place.

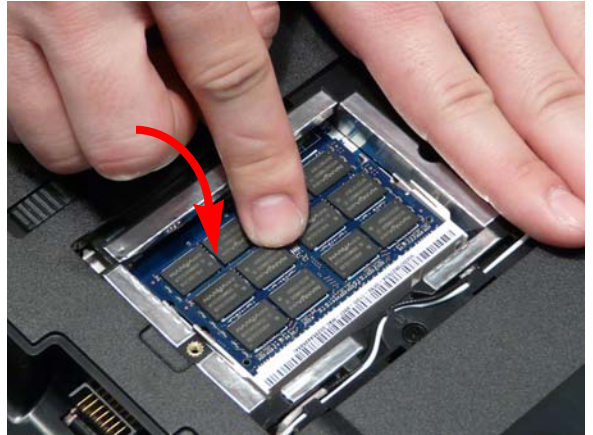
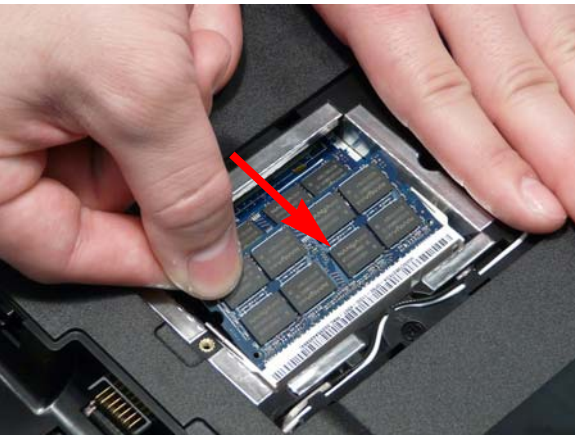

3. Repeat steps for the second DIMM module if present.

# Replacing the ODD Module

1. Press the bezel into the tray, bottom edge first, to secure it to the ODD Module.
2. Secure the ODD bracket with the two screws.



3. Push the ODD Module into the ODD bay until it is flush with the casing.
4. Replace the single screw to secure the Module.

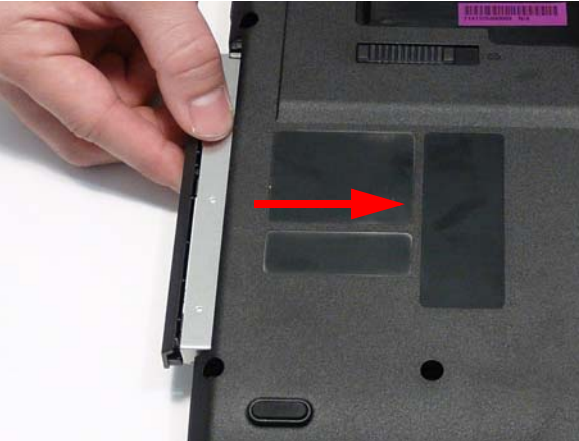

# Replacing the Lower Covers

1. Replace the Memory Cover as shown.
2. Replace the HDD Cover as shown.



**IMPORTANT:** Press down around the perimeter of the covers to ensure that all the securing tabs are correctly located in the casing.



- 
3. Replace the three screws to secure the covers in place.



## Replacing the SD Dummy Card

1. Insert the SD Dummy Card into the slot as shown. 2. Push until the card clicks into place and is flush with the casing.



---

## Replacing the Battery

1. Slide and hold the battery release latch to the release position (1), insert the battery pack and press down (2).

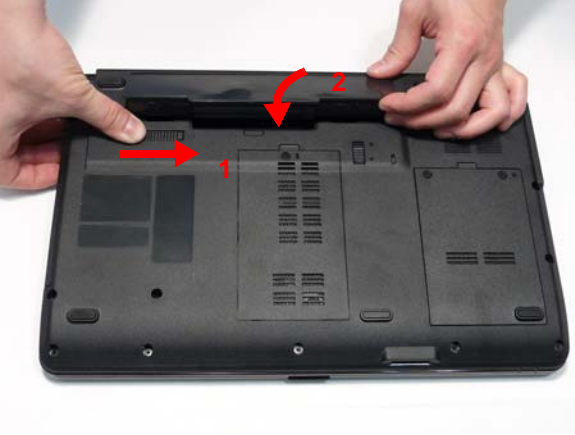

2. Slide the battery lock in the direction shown to secure the battery in place.







# Troubleshooting

---

## Common Problems

Use the following procedure as a guide for computer problems.

**NOTE:** The diagnostic tests are intended to test only Acer products. Non-Acer products, prototype cards, or modified options can give false errors and invalid system responses.

1. Obtain the failing symptoms in as much detail as possible.
2. Verify the symptoms by attempting to re-create the failure by running the diagnostic test or by repeating the same operation.
3. Use the following table with the verified symptom to determine which page to go to.

Symptoms (Verified)	Go To
Power On Issue	Page 122
No Display Issue	Page 123
LCD Failure	Page 125
Internal Keyboard Failure	Page 125
TouchPad Failure	Page 126
Internal Speaker Failure	Page 126
ODD Failure	Page 129
WLAN Failure	Page 132
Thermal Unit Failure	Page 132
Other Functions Failure	Page 133
Intermittent Failures	Page 134
Undermined Failures	Page 134

4. If the Issue is still not resolved, see "Online Support Information" on page 177.

---

## Power On Issue

If the system doesn't power on, perform the following actions one at a time to correct the problem. Do not replace a non-defective FRUs:

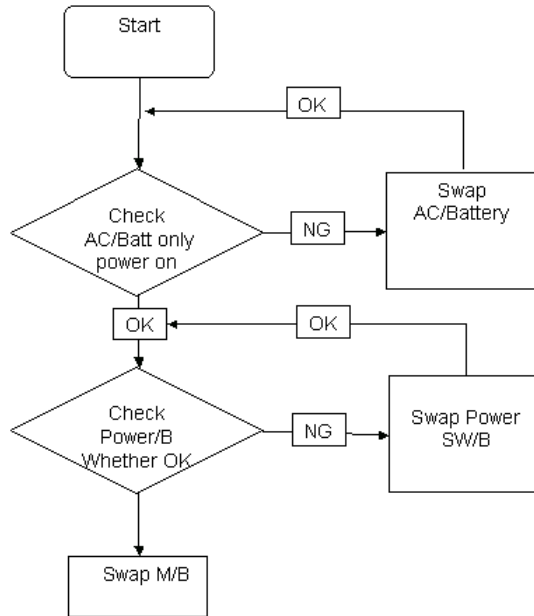

## Computer Shutdown Intermittently

If the system powers off at intervals, perform the following actions one at a time to correct the problem.

1. Check the power cable is properly connected to the computer and the electrical outlet.
2. Remove any extension cables between the computer and the outlet.
3. Remove any surge protectors between the computer and the electrical outlet. Plug the computer directly into a known good electrical outlet.
4. Disconnect the power and open the casing to check the Thermal Unit (see "Thermal Unit Failure" on page 132) and fan airways are free of obstructions.
5. Remove all external and non-essential hardware connected to the computer that are not necessary to boot the computer to the failure point.
6. Remove any recently installed software.
7. If the Issue is still not resolved, see "Online Support Information" on page 177.

# No Display Issue

If the **Display** doesn't work, perform the following actions one at a time to correct the problem. Do not replace a non-defective FRUs:

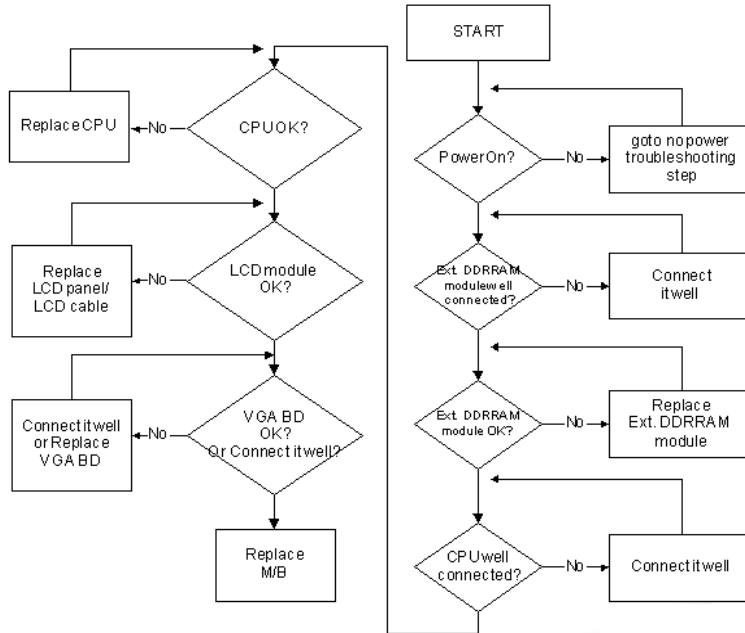

## No POST or Video

If the POST or video doesn't display, perform the following actions one at a time to correct the problem.

1. Make sure that the internal display is selected. On this notebook model, switching between the internal display and the external display is done by pressing **Fn+F5**. Reference Product pages for specific model procedures.
2. Make sure the computer has power by checking at least one of the following occurs:
  - Fans start up
  - Status LEDs light up

If there is no power, see "Power On Issue" on page 122.

3. Drain any stored power by removing the power cable and battery and holding down the power button for 10 seconds. Reconnect the power and reboot the computer.
4. Connect an external monitor to the computer and switch between the internal display and the external display is by pressing **Fn+F5** (on this model).

If the POST or video appears on the external display, see "LCD Failure" on page 125.

5. Disconnect power and all external devices including port replicators or docking stations. Remove any memory cards and CD/DVD discs. Restart the computer.

If the computer boots correctly, add the devices one by one until the failure point is discovered.

6. Reseat the memory modules.
7. Remove the drives (see "Disassembly Process" on page 42).
8. If the Issue is still not resolved, see "Online Support Information" on page 177.

---

## Abnormal Video Display

If video displays abnormally, perform the following actions one at a time to correct the problem.

1. Reboot the computer.
2. If permanent vertical/horizontal lines or dark spots display in the same location, the LCD is faulty and should be replaced. See “Disassembly Process” on page 42.
3. If extensive pixel damage is present (different colored spots in the same locations on the screen), the LCD is faulty and should be replaced. See “Disassembly Process” on page 42.
4. Adjust the brightness to its highest level. See the User Manual for instructions on adjusting settings.  
**NOTE:** Ensure that the computer is not running on battery alone as this may reduce display brightness.  
If the display is too dim at the highest brightness setting, the LCD is faulty and should be replaced. See “Disassembly Process” on page 42.
5. Check the display resolution is correctly configured:
  - a. Minimize or close all Windows.
  - b. If display size is only abnormal in an application, check the view settings and control/mouse wheel zoom feature in the application.
  - c. If desktop display resolution is not normal, right-click on the desktop and select **Personalize**→ **Display Settings**.
  - d. Click and drag the Resolution slider to the desired resolution.
  - e. Click **Apply** and check the display. Readjust if necessary.
6. Roll back the video driver to the previous version if updated.
7. Remove and reinstall the video driver.
8. Check the Device Manager to determine that:
  - The device is properly installed. There are no red Xs or yellow exclamation marks.
  - There are no device conflicts.
  - No hardware is listed under Other Devices.
9. If the Issue is still not resolved, see “Online Support Information” on page 177.
10. Run the Windows Memory Diagnostic from the operating system DVD and follow the onscreen prompts.
11. If the Issue is still not resolved, see “Online Support Information” on page 177.

## Random Loss of BIOS Settings

If the computer is experiencing intermittent loss of BIOS information, perform the following actions one at a time to correct the problem.

1. If the computer is more than one year old, replace the CMOS battery.
2. Run a complete virus scan using up-to-date software to ensure the computer is virus free.
3. If the computer is experiencing HDD or ODD BIOS information loss, disconnect and reconnect the power and data cables between devices.  
If the BIOS settings are still lost, replace the cables.
4. If HDD information is missing from the BIOS, the drive may be defective and should be replaced.
5. Replace the Motherboard.
6. If the Issue is still not resolved, see “Online Support Information” on page 177.

# LCD Failure

If the **LCD** fails, perform the following actions one at a time to correct the problem. Do not replace a non-defective FRUs:

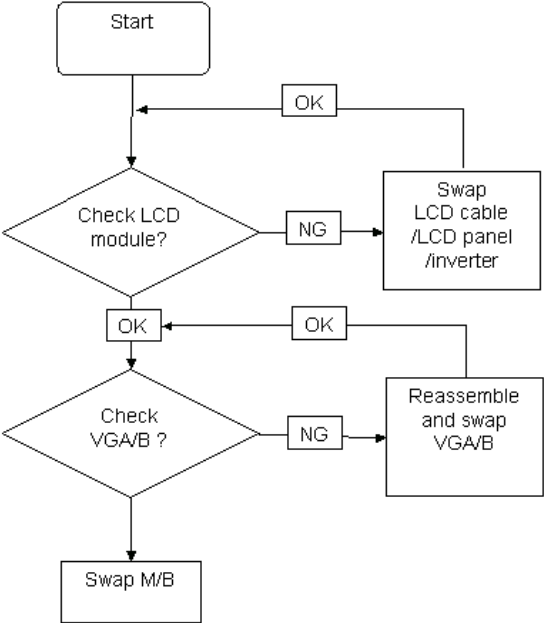

# Built-In Keyboard Failure

If the built-in **Keyboard** fails, perform the following actions one at a time to correct the problem. Do not replace a non-defective FRUs:

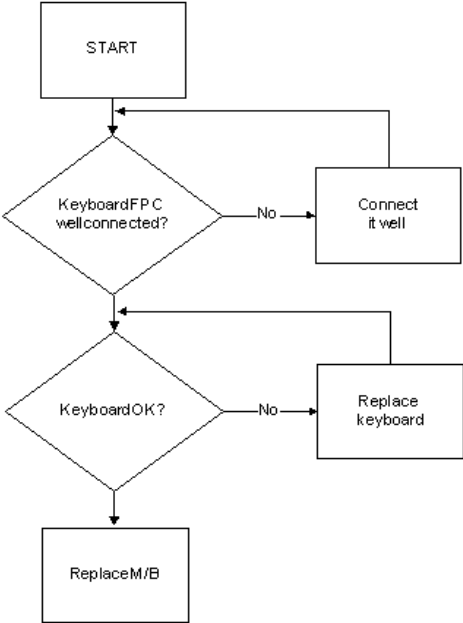

# TouchPad Failure

If the **TouchPad** doesn't work, perform the following actions one at a time to correct the problem. Do not replace a non-defective FRUs:

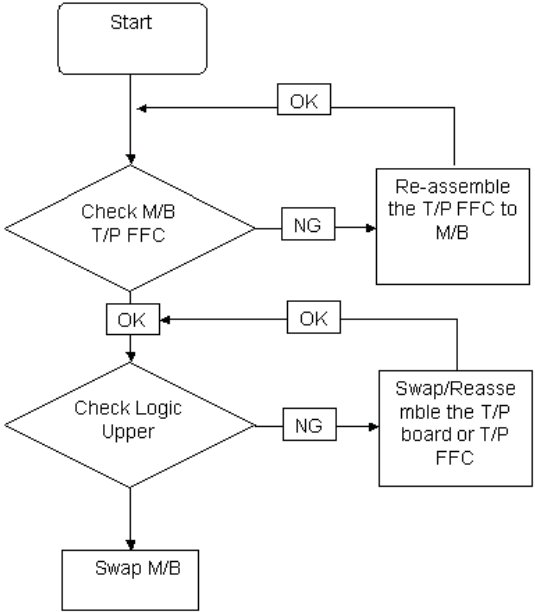

# Internal Speaker Failure

If the internal **Speakers** fail, perform the following actions one at a time to correct the problem. Do not replace a non-defective FRUs:

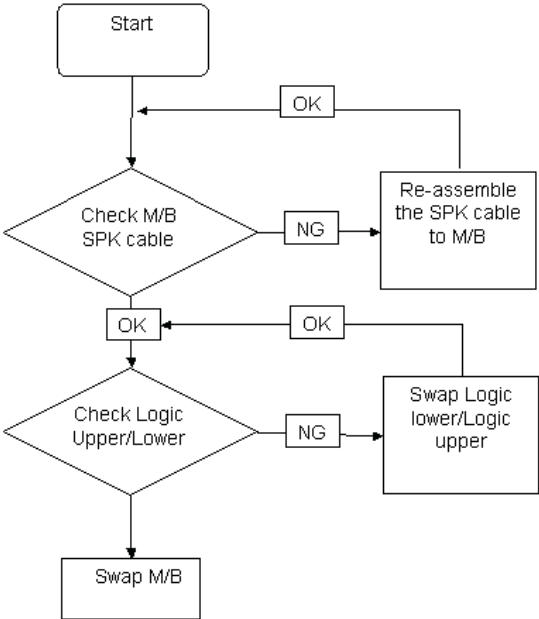



---

## Sound Problems

If sound problems are experienced, perform the following actions one at a time to correct the problem.

1. Reboot the computer.
2. Navigate to **Start**→ **Control Panel**→ **System and Maintenance**→ **System**→ **Device Manager**. Check the Device Manager to determine that:
  - The device is properly installed.
  - There are no red Xs or yellow exclamation marks.
  - There are no device conflicts.
  - No hardware is listed under Other Devices.
3. Roll back the audio driver to the previous version, if updated recently.
4. Remove and reinstall the audio driver.
5. Ensure that all volume controls are set mid range:
  - a. Click the volume icon on the taskbar and drag the slider to 50. Ensure that the volume is not muted.
  - b. Click Mixer to verify that other audio applications are set to 50 and not muted.
6. Navigate to **Start**→ **Control Panel**→ **Hardware and Sound**→ **Sound**. Ensure that Speakers are selected as the default audio device (green check mark).

**NOTE:** If Speakers does not show, right-click on the **Playback** tab and select **Show Disabled Devices** (clear by default).
7. Select Speakers and click **Configure** to start **Speaker Setup**. Follow the onscreen prompts to configure the speakers.
8. Remove and recently installed hardware or software.
9. Restore system and file settings from a known good date using **System Restore**.

If the issue is not fixed, repeat the preceding steps and select an earlier time and date.
10. Reinstall the Operating System.
11. If the Issue is still not resolved, see “Online Support Information” on page 177.

## Microphone Problems

If internal or external **Microphones** do not operate correctly, perform the following actions one at a time to correct the problem.

1. Check that the microphone is enabled. Navigate to **Start**→ **Control Panel**→ **Hardware and Sound**→ **Sound** and select the **Recording** tab.
2. Right-click on the **Recording** tab and select **Show Disabled Devices** (clear by default).
3. The microphone appears on the **Recording** tab.
4. Right-click on the microphone and select **Enable**.
5. Select the microphone then click **Properties**. Select the **Levels** tab.
6. Increase the volume to the maximum setting and click **OK**.
7. Test the microphone hardware:
  - a. Select the microphone and click **Configure**.
  - b. Select **Set up microphone**.
  - c. Select the microphone type from the list and click **Next**.
  - d. Follow the onscreen prompts to complete the test.
8. If the Issue is still not resolved, see “Online Support Information” on page 177.

---

## HDD Not Operating Correctly

If the **HDD** does not operate correctly, perform the following actions one at a time to correct the problem.

1. Disconnect all external devices.
2. Run a complete virus scan using up-to-date software to ensure the computer is virus free.
3. Run the Windows Vista Startup Repair Utility:
  - a. insert the Windows Vista Operating System DVD in the ODD and restart the computer.
  - b. When prompted, press any key to start to the operating system DVD.
  - c. The **Install Windows** screen displays. Click **Next**.
  - d. Select **Repair your computer**.
  - e. The **System Recovery Options** screen displays. Click **Next**.
  - f. Select the appropriate operating system, and click **Next**.

**NOTE:** Click **Load Drivers** if controller drives are required.

- g. Select **Startup Repair**.
- h. Startup Repair attempts to locate and resolve issues with the computer.
- i. When complete, click **Finish**.

If an issue is discovered, follow the onscreen information to resolve the problem.

4. Run the Windows Memory Diagnostic Tool. For more information see Windows Help and Support.
5. Restart the computer and press F2 to enter the BIOS Utility. Check the BIOS settings are correct and that CD/DVD drive is set as the first boot device on the Boot menu.
6. Ensure all cables and jumpers on the HDD and ODD are set correctly.
7. Remove any recently added hardware and associated software.
8. Run the Windows Disk Defragmenter. For more information see Windows Help and Support.
9. Run Windows Check Disk by entering **chkdsk /r** from a command prompt. For more information see Windows Help and Support.
10. Restore system and file settings from a known good date using **System Restore**.

If the issue is not fixed, repeat the preceding steps and select an earlier time and date.
11. Replace the HDD. See "Disassembly Process" on page 42.

---

## ODD Failure

If the **ODD** fails, perform the following actions one at a time to correct the problem. Do not replace a non-defective FRUs:

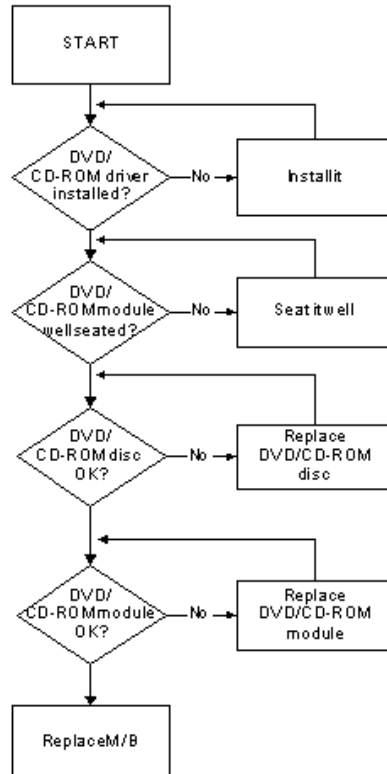

## ODD Not Operating Correctly

If the **ODD** exhibits any of the following symptoms it may be faulty:

- Audio CDs do not play when loaded
- DVDs do not play when loaded
- Blank discs do not burn correctly
- DVD or CD play breaks up or jumps
- Optical drive not found or not active:
  - Not shown in My Computer or the BIOS setup
  - LED does not flash when the computer starts up
  - The tray does not eject
- Access failure screen displays
- The ODD is noisy

Perform the following general solutions one at a time to correct the problem.

1. Reboot the computer and retry the operation.
2. Try an alternate disc.
3. Navigate to **Start** → **Computer**. Check that the ODD device is displayed in the **Devices with Removable Storage** panel.
4. Navigate to **Start** → **Control Panel** → **System and Maintenance** → **System** → **Device Manager**.

- 
- a. Double-click **IDE ATA/ATAPI controllers**. If a device displays a down arrow, right-click on the device and click **Enable**.
  - b. Double-click **DVD/CD-ROM drives**. If the device displays a down arrow, right-click on the device and click **Enable**.
  - c. Check that there are no yellow exclamation marks against the items in **IDE ATA/ATAPI controllers**. If a device has an exclamation mark, right-click on the device and uninstall and reinstall the driver.
  - d. Check that there are no yellow exclamation marks against the items in **DVD/CD-ROM drives**. If a device has an exclamation mark, right-click on the device and uninstall and reinstall the driver.
  - e. If the exclamation marker is not removed from the item in the lists, try removing any recently installed software and retrying the operation.

## Discs Do Not Play

If discs do not play when inserted in the drive, perform the following actions one at a time to correct the problem.

1. Check that the disc is correctly seated in the drive tray and that the label on the disc is visible.
2. Check that the media is clean and scratch free.
3. Try an alternate disc in the drive.
4. Ensure that **AutoPlay** is enabled:
  - a. Navigate to **Start** → **Control Panel** → **Hardware and Sound** → **AutoPlay**.
  - b. Select **Use AutoPlay for all media and devices**.
  - c. In the Audio CD and DVD Movie fields, select the desired player from the drop down menu.
5. Check that the Regional Code is correct for the selected media:

**IMPORTANT:**Region can only be changed a limited number of times. After Changes remaining reaches zero, the region cannot be changed even Windows is reinstalled or the drive is moved to another computer.

- a. Navigate to **Start** → **Control Panel** → **System and Maintenance** → **System** → **Device Manager**.
- b. Double-click **DVD/CD-ROM drives**.
- c. Right-click **DVD drive** and click **Properties**, then click the **DVD Region** tab.
- d. Select the region suitable for the media inserted in the drive.

## Discs Do Not Burn Properly

If discs can not be burned, perform the following actions one at a time to correct the problem.

1. Ensure that the default drive is record enabled:
  - a. Navigate to **Start** → **Computer** and right-click the writable ODD icon. Click **Properties**.
  - b. Select the **Recording** tab. In the **Desktop disc recording** panel, select the writable ODD from the drop down list.
  - c. Click **OK**.
2. Ensure that the software used for burning discs is the factory default. If using different software, refer to the software's user manual.

## Playback is Choppy

If playback is choppy or jumps, perform the following actions one at a time to correct the problem.

1. Check that system resources are not running low:
  - a. Try closing some applications.
  - b. Reboot and try the operation again.
2. Check that the ODD controller transfer mode is set to DMA:
  - a. Navigate to **Start** → **Control Panel** → **System and Maintenance** → **System** → **Device Manager**.

- 
- b. Double-click **IDE ATA/ATAPI controllers**, then right-click ATA Device 0.
  - c. Click **Properties** and select the **Advanced Settings** tab. Ensure that the **Enable DMA** box is checked and click **OK**.
  - d. Repeat for the other ATA Devices shown if applicable.

### Drive Not Detected

If Windows cannot detect the drive, perform the following actions one at a time to correct the problem.

1. Restart the computer and press F2 to enter the BIOS Utility.
2. Check that the drive is detected in the **ATAPI Model Name** field on the Information page.  
**NOTE:** Check that the entry is identical to one of the ODDs specified in “Hardware Specifications and Configurations” on page 17.
3. Turn off the power and remove the cover to inspect the connections to the ODD. See “Disassembly Process” on page 42.
  - a. Check for broken connectors on the drive, motherboard, and cables.
  - b. Check for bent or broken pins on the drive, motherboard, and cable connections.
  - c. Try an alternate cable, if available. If the drive works with the new cable, the original cable should be replaced.
4. Reseat the drive ensuring and all cables are connected correctly.
5. Replace the ODD. See “Disassembly Process” on page 42.

### Drive Read Failure

If discs cannot be read when inserted in the drive, perform the following actions one at a time to correct the problem.

1. Remove and clean the failed disc.
2. Retry reading the CD or DVD.
  - d. Test the drive using other discs.
  - e. Play a DVD movie
  - f. Listen to a music CD

If the ODD works properly with alternate discs, the original disc is probably defective and should be replaced.

3. Turn off the power and remove the cover to inspect the connections to the ODD. See “Disassembly Process” on page 42.
  - a. Check for broken connectors on the drive, motherboard, and cables.
  - b. Check for bent or broken pins on the drive, motherboard, and cable connections.
  - c. Try an alternate cable, if available. If the drive works with the new cable, the original cable should be replaced.
4. Replace the ODD. See “Disassembly Process” on page 42.

# Wireless Function Failure

If the **WLAN** fails, perform the following actions one at a time to correct the problem. Do not replace a non-defective FRUs:

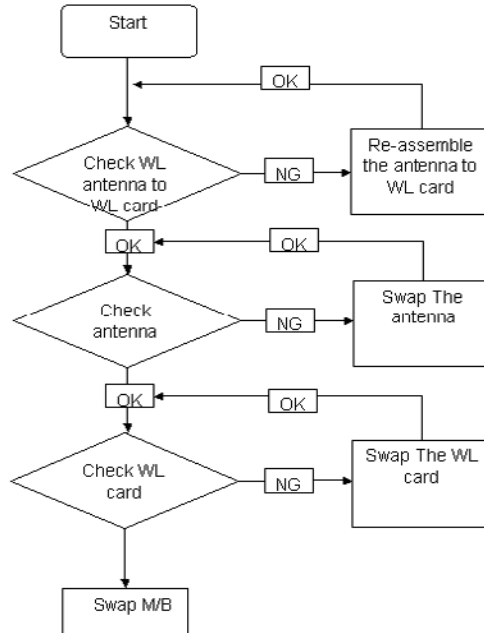

# Thermal Unit Failure

If the **Thermal Unit** fails, perform the following actions one at a time to correct the problem. Do not replace a non-defective FRUs:

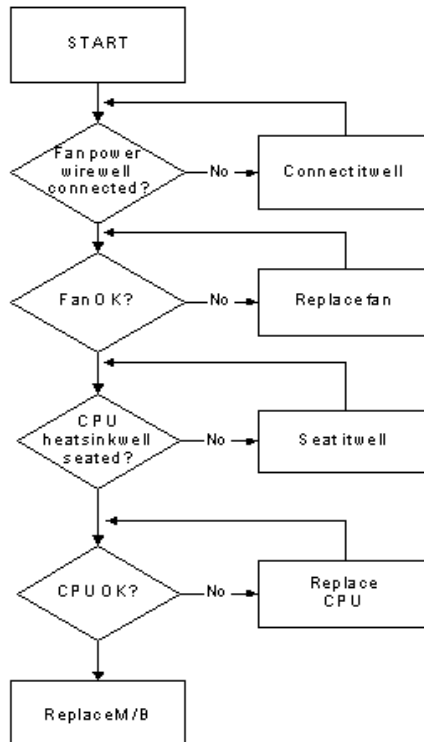

---

## External Mouse Failure

If an external **Mouse** fails, perform the following actions one at a time to correct the problem.

1. Try an alternative mouse.
2. If the mouse uses a wireless connection, insert new batteries and confirm there is a good connection. See the mouse user manual.
3. If the mouse uses a USB connection, try an alternate USB port.
4. Try an alternative program to verify mouse operation. Reinstall the program experiencing mouse failure.
5. Restart the computer.
6. Remove any recently added hardware and associated software.
7. Remove any recently added software and reboot.
8. Restore system and file settings from a known good date using **System Restore**.

If the issue is not fixed, repeat the preceding steps and select an earlier time and date.

9. Run the Event Viewer to check the events log for errors. For more information see Windows Help and Support.
10. Roll back the mouse driver to the previous version if updated recently.
11. Remove and reinstall the mouse driver.
12. Check the Device Manager to determine that:
  - The device is properly installed. There are no red Xs or yellow exclamation marks.
  - There are no device conflicts.
  - No hardware is listed under Other Devices.
13. If the Issue is still not resolved, see "Online Support Information" on page 177.

## Other Failures

If the CRT Switch, Dock, LAN Port, external MIC or Speakers, PCI Express Card, 5-in-1 Card Reader or Volume Wheel fail, perform the following general steps to correct the problem. Do not replace a non-defective FRUs:

1. Check Drive whether is OK.
2. Check Test Fixture is ok.
3. Swap M/B to Try.



---

# Intermittent Problems

Intermittent system hang problems can be caused by a variety of reasons that have nothing to do with a hardware defect, such as: cosmic radiation, electrostatic discharge, or software errors. FRU replacement should be considered only when a recurring problem exists.

When analyzing an intermittent problem, do the following:

1. Run the advanced diagnostic test for the system board in loop mode at least 10 times.
2. If no error is detected, do not replace any FRU.
3. If any error is detected, replace the FRU. Rerun the test to verify that there are no more errors.

# Undetermined Problems

The diagnostic problems does not identify which adapter or device failed, which installed devices are incorrect, whether a short circuit is suspected, or whether the system is inoperative.

Follow these procedures to isolate the failing FRU (do not isolate non-defective FRU).

**NOTE:** Verify that all attached devices are supported by the computer.

**NOTE:** Verify that the power supply being used at the time of the failure is operating correctly. (See “Power On Issue” on page 122.):

1. Power-off the computer.
2. Visually check them for damage. If any problems are found, replace the FRU.
3. Remove or disconnect all of the following devices:
  - Non-Acer devices
  - Printer, mouse, and other external devices
  - Battery pack
  - Hard disk drive
  - DIMM
  - CD-ROM/Diskette drive Module
  - PC Cards
4. Power-on the computer.
5. Determine if the problem has changed.
6. If the problem does not recur, reconnect the removed devices one at a time until you find the failing FRU.
7. If the problem remains, replace the following FRU one at a time. Do not replace a non-defective FRU:
  - System board
  - LCD assembly

# Post Codes

These tables describe the POST codes and descriptions during the POST.

Code	Beeps	POST Routine Description
02h		Verify Real Mode
03h		Disable Non-Maskable Interrupt (NMI)
04h		Get CPU type
06h		Initialize system hardware
08h		Initialize chipset with initial POST values
09h		Set IN POST flag
0Ah		Initialize CPU registers
0Bh		Enable CPU cache
0Ch		Initialize caches to initial POST values
0Eh		Initialize I/O component
0Fh		Initialize the local bus IDE
10h		Initialize Power Management
11h		Load alternate registers with initial POST values
12h		Restore CPU control word during warm boot
13h		Initialize PCI Bus Mastering devices
14h		Initialize keyboard controller
16h	1-2-2-3	BIOS ROM checksum
17h		Initialize cache before memory autosize
18h		8254 timer initialization
1Ah		8237 DMA controller initialization
1Ch		Reset Programmable Interrupt Controller
20h	1-3-1-1	Test DRAM refresh
22h	1-3-1-3	Test 8742 Keyboard Controller
24h		Set ES segment register to 4 GB
26h		Enable A20 line
28h		Autosize DRAM
29h		Initialize POST Memory Manager
2Ah		Clear 512 KB base RAM
2Ch	1-3-4-1	RAM failure on address line xxxx*
2Eh	1-3-4-3	RAM failure on data bits xxxx* of low byte of memory bus
2Fh		Enable cache before system BIOS shadow
30h	1-4-1-1	RAM failure on data bits xxxx* of high byte of memory bus
32h		Test CPU bus-clock frequency
33h		Initialize Phoenix Dispatch Manager
36h		Warm start shut down
38h		Shadow system BIOS ROM
3Ah		Autosize cache
3Ch		Advanced configuration of chipset registers
3Dh		Load alternate registers with CMOS values
42h		Initialize interrupt vectors

Code	Beeps	POST Routine Description
45h		POST device initialization
46h	2-1-2-3	Check ROM copyright notice
48h		Check video configuration against CMOS
49h		Initialize PCI bus and devices
4Ah		Initialize all video adapters in system
4Bh		QuietBoot start (optional)
4Ch		Shadow video BIOS ROM
4Eh		Display BIOS copyright notice
50h		Display CPU type and speed
51h		Initialize EISA board
52h		Test keyboard
54h		Set key click if enabled
58h	2-2-3-1	Test for unexpected interrupts
59h		Initialize POST display service
5Ah		Display prompt "Press F2 to enter SETUP"
5Bh		Disable CPU cache
5Ch		Test RAM between 512 and 640 KB
60h		Test extended memory
62h		Test extended memory address lines
64h		Jump to UserPatch1
66h		Configure advanced cache registers
67h		Initialize Multi Processor APIC
68h		Enable external and CPU caches
69h		Setup System Management Mode (SMM) area
6Ah		Display external L2 cache size
6Bh		Load custom defaults (optional)
6Ch		Display shadow-area message
6Eh		Display possible high address for UMB recovery
70h		Display error messages
72h		Check for configuration errors
76h		Check for keyboard errors
7Ch		Set up hardware interrupt vectors
7Eh		Initialize coprocessor if present
80h		Disable onboard Super I/O ports and IRQs
81h		Late POST device initialization
82h		Detect and install external RS232 ports
83h		Configure non-MCD IDE controllers
84h		Detect and install external parallel ports
85h		Initialize PC-compatible PnP ISA devices
86h		Re-initialize onboard I/O ports.
87h		Configure Motheboard Configurable Devices (optional)
88h		Initialize BIOS Data Area
89h		Enable Non-Maskable Interrupts (NMIs)

Code	Beeps	POST Routine Description
8Ah		Initialize Extended BIOS Data Area
8Bh		Test and initialize PS/2 mouse
8Ch		Initialize floppy controller
8Fh		Determine number of ATA drives (optional)
90h		Initialize hard-disk controllers
91h		Initialize local-bus hard-disk controllers
92h		Jump to UserPatch2
93h		Build MPTABLE for multi-processor boards
95h		Install CD ROM for boot
96h		Clear huge ES segment register
97h		Fixup Multi Processor table
98h	1-2	Search for option ROMs. One long, two short beeps on checksum failure
99h		Check for SMART Drive (optional)
9Ah		Shadow option ROMs
9Ch		Set up Power Management
9Dh		Initialize security engine (optional)
9Eh		Enable hardware interrupts
9Fh		Determine number of ATA and SCSI drives
A0h		Set time of day
A2h		Check key lock
A4h		Initialize Typematic rate
A8h		Erase F2 prompt
AAh		Scan for F2 key stroke
ACh		Enter SETUP
A Eh		Clear Boot flag
B0h		Check for errors
B2h		POST done - prepare to boot operating system
B4h	1	One short beep before boot
B5h		Terminate QuietBoot (optional)
B6h		Check password (optional)
B9h		Prepare Boot
BAh		Initialize DMI parameters
BBh		Initialize PnP Option ROMs
BCh		Clear parity checkers
BDh		Display MultiBoot menu
BEh		Clear screen (optional)
BFh		Check virus and backup reminders
C0h		Try to boot with INT 19
C1h		Initialize POST Error Manager (PEM)
C2h		Initialize error logging
C3h		Initialize error display function
C4h		Initialize system error handler

Code	Beeps	POST Routine Description
C5h		PnPnd dual CMOS (optional)
C6h		Initialize notebook docking (optional)
C7h		Initialize notebook docking late
C8h		Force check (optional)
C9h		Extended checksum (optional)
D2h		Unknown interrupt

Code	Beeps	For Boot Block in Flash ROM
E0h		Initialize the chipset
E1h		Initialize the bridge
E2h		Initialize the CPU
E3h		Initialize system timer
E4h		Initialize system I/O
E5h		Check force recovery boot
E6h		Checksum BIOS ROM
E7h		Go to BIOS
E8h		Set Huge Segment
E9h		Initialize Multi Processor
EAh		Initialize OEM special code
EBh		Initialize PIC and DMA
ECh		Initialize Memory type
EDh		Initialize Memory size
EEh		Shadow Boot Block
EFh		System memory test
F0h		Initialize interrupt vectors
F1h		Initialize Run Time Clock
F2h		Initialize video
F3h		Initialize System Management Mode
F4h	1	Output one beep before boot
F5h		Boot to Mini DOS
F6h		Clear Huge Segment
F7h		Boot to Full DOS

\* If the BIOS detects error 2C, 2E, or 30 (base 512K RAM error), it displays an additional word-bitmap (xxxx) indicating the address line or bits that failed. For example, "2C 0002" means address line 1 (bit one set) has failed. "2E 1020" means data bits 12 and 5 (bits 12 and 5 set) have failed in the lower 16 bits. Note that error 30 cannot occur on 386SX systems because they have a 16 rather than 32-bit bus. The BIOS also sends the bitmap to the port-80 LED display. It first displays the check point code, followed by a delay, the high-order byte, another delay, and then the low-order byte of the error. It repeats this sequence continuously.

# Jumper and Connector Locations

## Top View

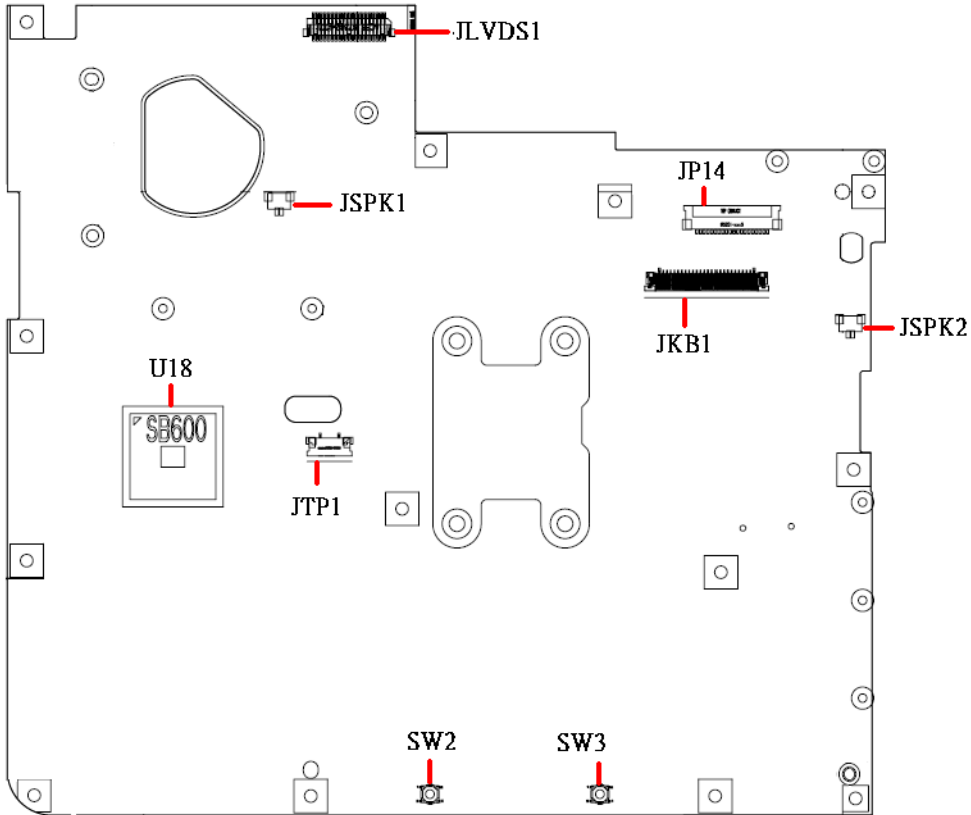

Item	Description
JLVD1	LCD Connector
JP14	Power/B Connector
JSPK1	Speaker(Left) Connector
JSPK2	Speaker(Right) Connector
JKB1	Internal Keyboard Connector
JTP1	Touch Pad Connector
U18	South Bridge
SW2	Touch pad (Left) Button
SW3	Touch pad (Right) Button

## Bottom View

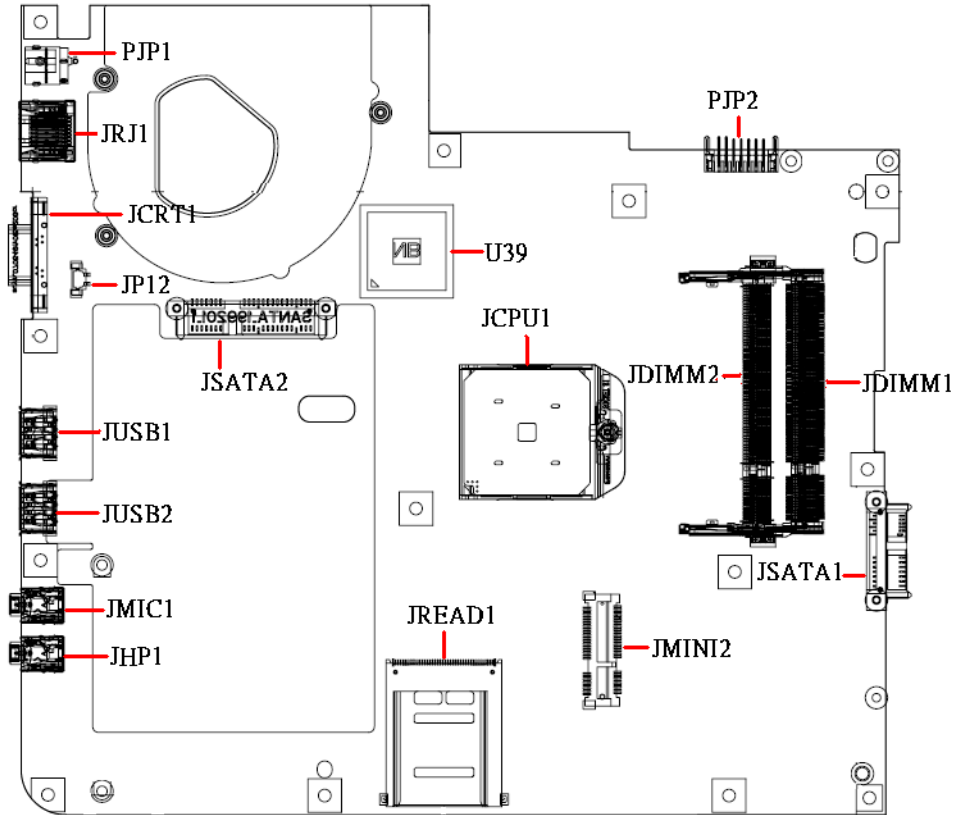

ITEM	DESCRIPTION
PJP1	AC-IN Connector
JRJ1	RJ45 Connector
JCRT1	CRT Connector
JP12	Fan Connector
JUSB1	USB Connector
JUSB2	USB Connector
JMIC1	MIC-In Jack
JHP1	Head-Phone Jack
JSATA2	HDD Connector
U39	North Bridge
JCPU1	CPU Socket
JREAD1	Card Reader Socket
PJP2	Battery Connector
JDIMM2	Memory DIMM2 Connector
JDIMM1	Memory DIMM1 Connector
JSATA1	ODD Connector
JMINI2	Wireless Card Connector



# Power Board

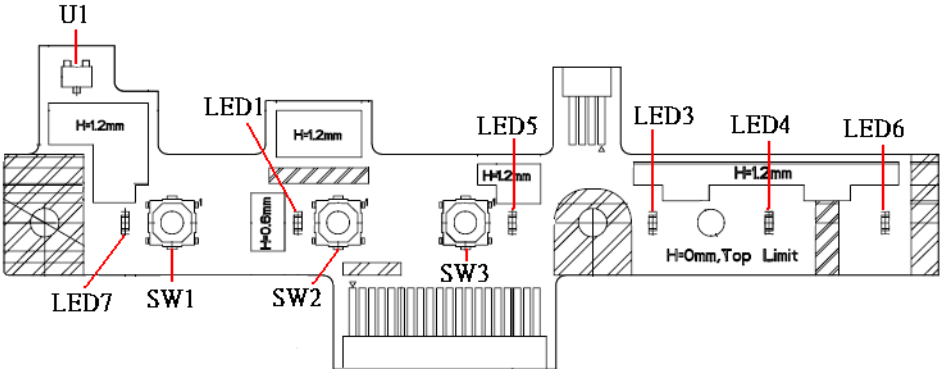

ITEM	DESCRIPTION
U1	Lid Switch
SW1	TP Lock Button
SW2	ON/OFF Button
SW3	Wireless Button
LED1	ON/OFF LED
LED3	Media LED
LED4	Num LED
LED5	Wireless LED
LED6	Caps LED
LED7	TP Lock LED

# Clearing Password Check and BIOS Recovery

This section provides you with the standard operating procedures of clearing password and BIOS recovery for eMachines E627. The machine provides one Hardware Open Gap on main board for clearing password check, and one Hotkey for enabling BIOS Recovery.

## Clearing Password Check

### Steps for Clearing BIOS Password Check

If users set BIOS Password (Supervisor Password and/or User Password) for a security reason, BIOS will ask the password during systems POST or when systems enter to BIOS Setup menu. However, once it is necessary to bypass the password check, users need to short the HW Gap to clear the password by the following steps:

1. Power Off the system, and remove HDD, AC and Battery from the machine.
2. Disconnect the RTC Battery cable and locate the J1 jumper.
3. Use an electric conductivity tool to short the two points of the HW Gap.
4. Plug in AC, keep the short condition on the HW Gap, and press Power Button to power on the system till BIOS POST finish. Then remove the tool from the HW Gap.
5. Restart system. Press **F2** key to enter BIOS Setup menu.
6. If there is no Password request, BIOS Password is cleared. Otherwise, please follow the steps and try again.

**NOTE:** These steps are only for clearing BIOS Password (Supervisor Password and User Password).

## Clear CMOS Jumper

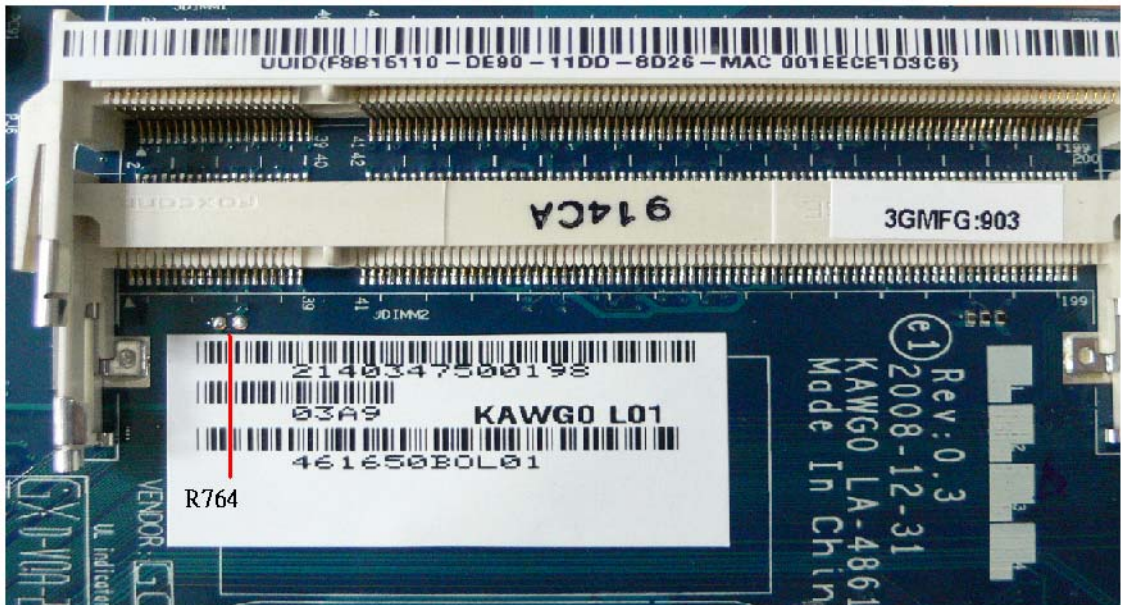

Item	Description	Location
J1	Clear CMOS Jumper	Thermal Module Bay, under Modem Board

---

# BIOS Recovery by Crisis Disk

## BIOS Recovery Boot Block:

BIOS Recovery Boot Block is a special block of BIOS. It is used to boot up the system with minimum BIOS initialization. Users can enable this feature to restore the BIOS firmware to a successful one once the previous BIOS flashing process failed.

## BIOS Recovery Hotkey:

The system provides a function hotkey: **Fn+Esc**, for enable BIOS Recovery process when system is powered on during BIOS POST. To use this function, it is strongly recommended to have the AC adapter and Battery present. If this function is enabled, the system will force the BIOS to enter a special BIOS block, called Boot Block.

## Steps for BIOS Recovery from USB Storage:

Before doing this, prepare the Crisis USB key. The Crisis USB key could be made by executing the Crisis Disk program in another system with Windows XP OS.

Follow the steps below:

1. Copy the **xxxxx.wph** BIOS file into the Crisis folder which is included with the crisis program.
2. Rename the **xxxxx.wph** file to **BIOS.wph**.
3. Plug in the USB disk.
4. Launch the **wincris.exe** program to create a USB Crisis Disk. Click **Start** to initiate the process.
5. Select the **Quick Format** option to format the disk and click **Start**. Follow the instructions on the screen to create the disk.

To use the Crisis USB key, do the following:

1. Plug USB storage into USB port.
2. Press **Fn + ESC** button then plug in AC power.  
The Power button flashes orange once.
3. Press **Power** button to initiate system CRISIS mode.  
When CRISIS is complete, the system auto restarts with a workable BIOS.
4. Update the latest version BIOS for this machine by regular BIOS flashing process.



## FRU (Field Replaceable Unit) List

---

This chapter gives you the FRU (Field Replaceable Unit) listing in global configurations of eMachines E627. Refer to this chapter whenever ordering for parts to repair or for RMA (Return Merchandise Authorization).

Please note that WHEN ORDERING FRU PARTS, you should check the most up-to-date information available on your regional web or channel. For whatever reasons a part number change is made, it will not be noted on the printed Service Guide. For ACER AUTHORIZED SERVICE PROVIDERS, your Acer office may have a DIFFERENT part number code from those given in the FRU list of this printed Service Guide. You MUST use the local FRU list provided by your regional Acer office to order FRU parts for repair and service of customer machines.

NOTE: To scrap or to return the defective parts, you should follow the local government ordinance or regulations on how to dispose it properly, or follow the rules set by your regional Acer office on how to return it.

# eMachines E627 Exploded Diagrams

## Main Assembly

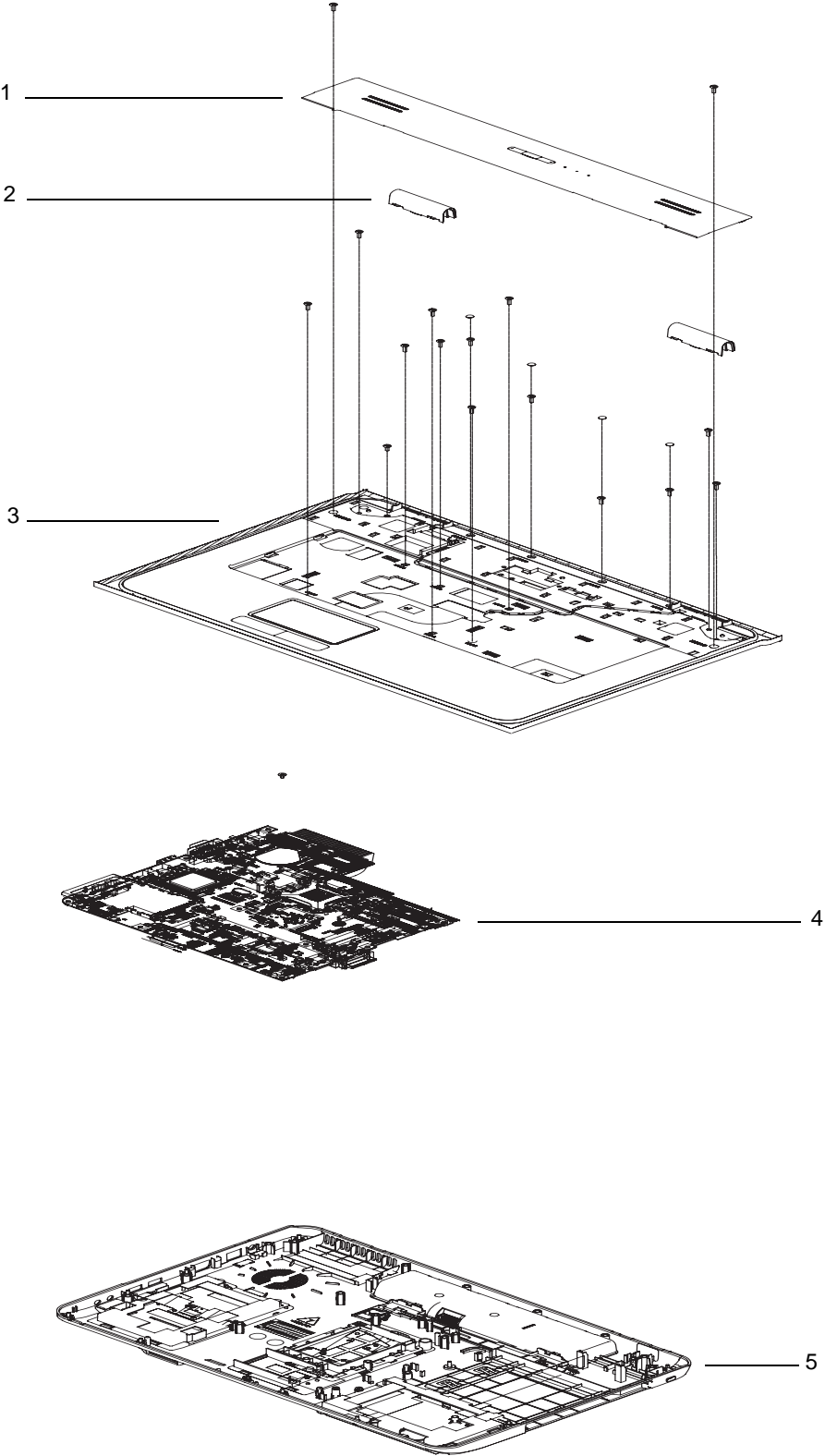

---

No.	Description	Acer P/N
1	Middle Cover Assy	60.N2802.003
2	Hinge Cap Assy	42.N2802.001
3	Upper Case Assy	60.N2802.001
4	Mainboard	MB.N6502.001
5	Lower Case	60.N2802.002



# Base Assembly

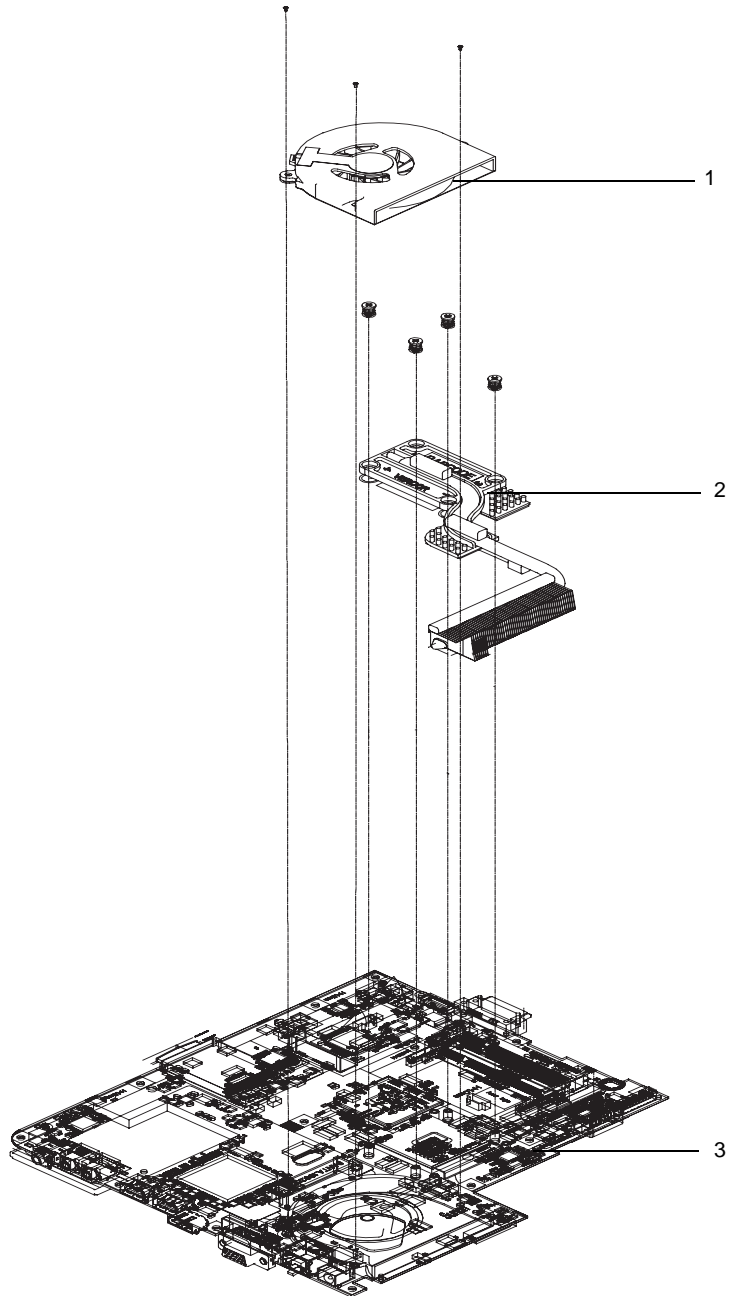

No.	Description	Acer P/N
1	Fan	23.N2802.001
2	Thermal Module	60.N6502.001
3	Mainboard	MB.N6502.001

# Rear Assembly

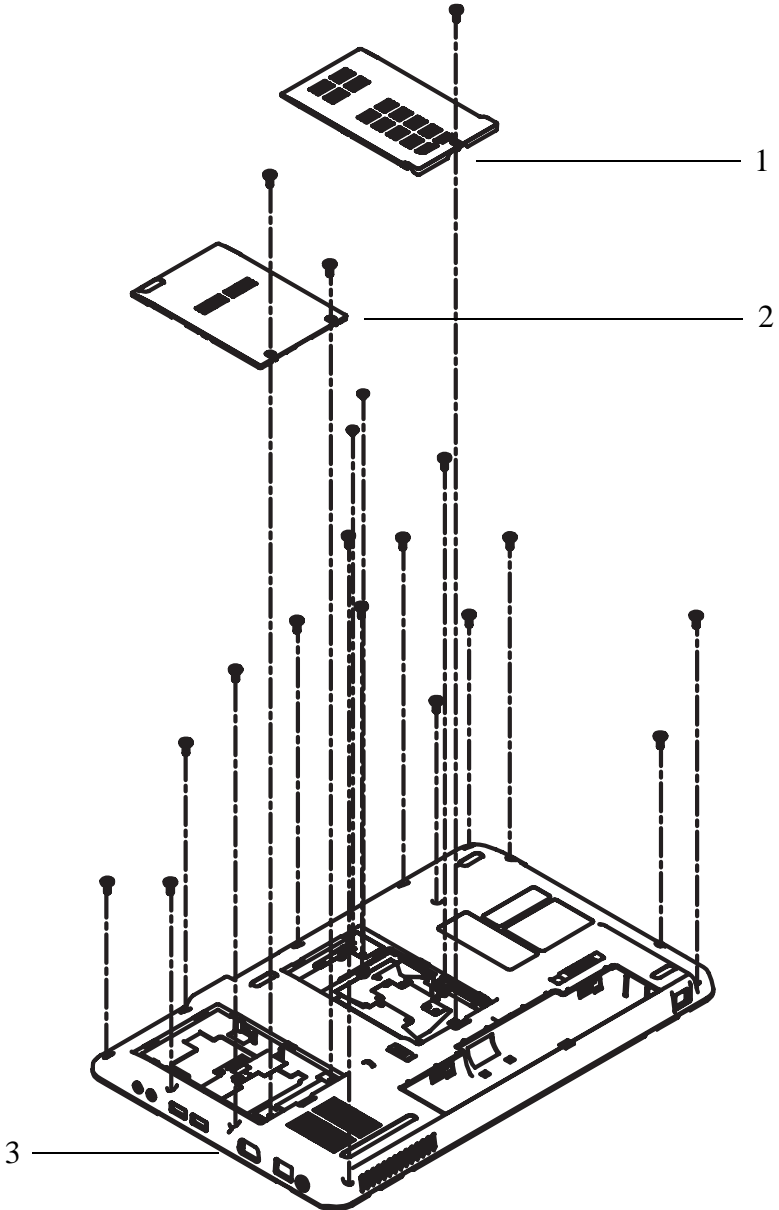



No.	Description	Acer P/N
1	RAM Door	42.N2802.004
2	HDD Door	42.N2802.005
3	Lower Case	60.N2802.002









# eMachines E627 FRU List

CATEGORY	Description	AcerPN
<b>Board</b>		
	POWER BOARD	55.N2802.001
	WLAN CARD-XB63	NI.23600.007
	WLAN CARD-BCM4312	NI.23600.029
<b>Cable</b>		
	TP FFC	50.N2802.001
	POWER CORD US 3 PIN	27.TAVV5.001
	POWER CORD EU 3 PIN	27.TAVV5.002
	POWER CORD AUS 3 PIN	27.TAVV5.003
	POWER CORD UK 3 PIN	27.TAVV5.004
	POWER CORD CHINA 3 PIN	27.TAVV5.005
	POWER CORD SWISS 3 PIN	27.TAVV5.006
	POWER CORD ITALIAN 3 PIN	27.TAVV5.007
	POWER CORD DENMARK 3 PIN	27.TAVV5.008
	POWER CORD JP 3 PIN	27.TAVV5.009
	POWER CORD SOUTH AFRICA 3 PIN	27.TAVV5.010
	POWER CORD KOERA 3 PIN	27.TAVV5.011
	POWER CORD ISRAEL 3 PIN	27.TAVV5.012
	POWER CORD INDIA 3 PIN	27.TAVV5.013
	POWER CORD TWN 3 PIN	27.TAVV5.014
POWER CORD ARGENTINA 3 PIN	27.APV02.001	
<b>CPU/Processor</b>		
	CPU AMD Athlon TF20 PGA 1.6G 512K 638 15W G2	KC.ATF02.200
	CPU AMD AthlonX2 TK42 1.6G 1M 638 20W G2	KC.ATK02.420
<b>Case/Cover/Bracket Assembly</b>		
	UPPER CASE ASSY	60.N2802.001

CATEGORY	Description	AcerPN
	LOWER CASE	60.N2802.002
	TP BRACKET	33.N2802.001
	MIDDLE COVER ASSY	60.N2802.003
	HINGE CAP ASSY	42.N2802.001
	UP CAP R	42.N2802.002
	UP CAP L	42.N2802.003
	RAM DOOR ASSY	42.N2802.004
	HDD DOOR ASSY	42.N2802.005

CATEGORY	Description	AcerPN
<b>HDD</b>		
	HDD SEAGATE 2.5" 5400rpm 160GB ST9160310AS Crockett SATA LF F/W:0303	KH.16001.034
	HDD TOSHIBA 2.5" 5400rpm 160GB MK1655GSX Libra SATA LF F/W: FG011J	KH.16004.006
	HDD HGST 2.5" 5400rpm 160GB HTS543216L9A300 Falcon-B SATA LF F/W:C40C	KH.16007.019
	HDD WD 2.5" 5400rpm 160GB WD1600BEVT-22ZCTO ML160 SATA LF F/W:11.01A11	KH.16008.022
	HDD SEAGATE 2.5" 5400rpm 250GB ST9250315AS Wyatt SATA LF F/W:0001SDM1	KH.25001.016
	HDD TOSHIBA 2.5" 5400rpm 250GB MK2555GSX Libra SATA LF F/W:FG001J	KH.25004.003
	HDD HGST 2.5" 5400rpm 250GB HTS545025B9A300 Panther B SATA LF F/W:C60F	KH.25007.015
	HDD WD 2.5" 5400rpm 250GB WD2500BEVT-22ZCT0 ML160 SATA LF F/W:11.01A11	KH.25008.021
	HDD SEAGATE 2.5" 5400rpm 320GB ST9320320AS Crockett SATA LF F/W:0303	KH.32001.008
	HDD TOSHIBA 2.5" 5400rpm 320GB MK3255GSX Libra SATA LF F/W:FG011J	KH.32004.002
	HDD HGST 2.5" 5400rpm 320GB HTS545032B9A300 Panther B SATA LF F/W: C60F	KH.32007.007
	HDD WD 2.5" 5400rpm 320GB WD3200BEVT-22ZCT0 ML160 SATA LF F/W:11.01A11	KH.32008.013
	HDD SEAGATE 2.5" 5400rpm 500GB ST9500325AS Wyatt SATA LF F/W:0001SDM1	KH.50001.011
	HDD WD 2.5" 5400rpm 500GB WD5000BEVT-22ZAT0 ML250 SATA LF F/W:01.01A01	KH.50008.013
	HDD HGST 2.5" 5400rpm 500GB HTS545050B9A300 Panther B SATA LF F/W:C60F	KH.50007.009
HDD HGST 2.5" 5400rpm 160GB HTS545016B9A300 Panther B SATA LF F/W:C60F	KH.16007.024	
	HDD BRACKET ASSY	33.N2802.002
<b>ODD</b>		
	DVD SUPER MULTI DRIVE MODULE	6M.N2802.003
	ODD TOSHIBA Super-Multi DRIVE 12.7mm Tray DL 8X TS-L633B LF W/O bezel SATA	KU.00801.030
	ODD PANASONIC Super-Multi DRIVE 12.7mm Tray DL 8X UJ880A LF W/O bezel SATA	KU.00807.064
	ODD HLDS Super-Multi DRIVE 12.7mm Tray DL 8X GT20N LF W/O bezel SATA	KU.0080D.040
	ODD SONY Super-Multi DRIVE 12.7mm Tray DL 8X AD- 7580S LF W/O bezel SATA	KU.0080E.017
	ODD PLDS Super-Multi DRIVE 12.7mm Tray DL 8X DS- 8A3S LF W/O bezel SATA	KU.0080F.004

CATEGORY	Description	AcerPN
	ODD BEZEL-SUPER MULTI	42.N2802.006
	ODD BRACKET	33.N2802.003
<b>Keyboard</b>		
	Keyboard EM-7T HM50/70 Internal 17 Standard 99KS Black US International	KB.I1700.438
	Keyboard EM-7T HM50/70 Internal 17 Standard 99KS Black Greek	KB.I1700.423
	Keyboard EM-7T HM50/70 Internal 17 Standard 99KS Black Arabic	KB.I1700.414
	Keyboard EM-7T HM50/70 Internal 17 Standard 99KS Black Russian	KB.I1700.430
	Keyboard EM-7T HM50/70 Internal 17 Standard 99KS Black Thailand	KB.I1700.435
	Keyboard EM-7T HM50/70 Internal 17 Standard 100KS Black UK	KB.I1700.437
	Keyboard EM-7T HM50/70 Internal 17 Standard 100KS Black German	KB.I1700.422
	Keyboard EM-7T HM50/70 Internal 17 Standard 100KS Black Swiss/G	KB.I1700.434
	Keyboard EM-7T HM50/70 Internal 17 Standard 100KS Black CZ/SK	KB.I1700.417
	Keyboard EM-7T HM50/70 Internal 17 Standard 100KS Black Belgium	KB.I1700.415
	Keyboard EM-7T HM50/70 Internal 17 Standard 100KS Black Danish	KB.I1700.419
	Keyboard EM-7T HM50/70 Internal 17 Standard 100KS Black Italian	KB.I1700.425
	Keyboard EM-7T HM50/70 Internal 17 Standard 100KS Black French	KB.I1700.421
	Keyboard EM-7T HM50/70 Internal 17 Standard 100KS Black Hungarian	KB.I1700.424
	Keyboard EM-7T HM50/70 Internal 17 Standard 100KS Black Norwegian	KB.I1700.428
	Keyboard EM-7T HM50/70 Internal 17 Standard 100KS Black Portuguese	KB.I1700.429
	Keyboard EM-7T HM50/70 Internal 17 Standard 100KS Black Spanish	KB.I1700.432
	Keyboard EM-7T HM50/70 Internal 17 Standard 100KS Black Turkish	KB.I1700.436
	Keyboard EM-7T HM50/70 Internal 17 Standard 100KS Black Sweden	KB.I1700.433
	Keyboard EM-7T HM50/70 Internal 17 Standard 100KS Black SLO/CRO	KB.I1700.431
Keyboard EM-7T HM50/70 Internal 17 Standard 100KS Black Nordic	KB.I1700.427	



CATEGORY	Description	AcerPN
<b>LCD</b>		
	ASSY LCD MODULE 15.6 IN. WXGA GLARE W/ ANTENNA*2, CCD 0.3M	6M.N2802.001
	LCD AUO 15.6" WXGA Glare B156XW01-V0 LF 220nit 8ms	LK.15605.001
	CCFL LCD AUO 15.6"W WXGA Glare B156XW01 V0 1A LF 220nit 8ms 500:1	LK.15605.002
	CCFL LCD SAMSUNG 15.6"W WXGA Glare LTN156AT01-A01 LF 220nit 8ms 600:1	LK.15606.001
	CCFL LCD LPL 15.6" WXGA Glare LP156WH1-TLA1 LF 220nit 8ms 400:1	LK.15608.001
	LCD CMO 15.6" WXGA Glare N156B3-L02 LF 220nit 8ms	LK.1560D.001
	LCD COVER	60.N2802.004
	ANTENNA-AUX	50.N2802.002
	ANTENNA-MAIN	50.N2802.003
	LCD BEZEL FOR W/CCD F	60.N2802.005
	LCD CABLE FOR W/CCD F	50.N2802.005
	LCD BRACKET R&L FOR LCD	33.N2802.004
	CAMERA 0.3	57.N2802.001
	INVERTER	19.N2802.001



CATEGORY	Description	AcerPN
	ASSY LCD MODULE 15.6 IN. WXGA GLARE W/O CCD	6M.N3202.001
	LCD AUO 15.6" WXGA Glare B156XW01-V0 LF 220nit 8ms	LK.15605.001
	CCFL LCD AUO 15.6"W WXGA Glare B156XW01 V0 1A LF 220nit 8ms 500:1	LK.15605.002
	CCFL LCD SAMSUNG 15.6"W WXGA Glare LTN156AT01-A01 LF 220nit 8ms 600:1	LK.15606.001
	CCFL LCD LPL 15.6" WXGA Glare LP156WH1-TLA1 LF 220nit 8ms 400:1	LK.15608.001
	LCD CMO 15.6" WXGA Glare N156B3-L02 LF 220nit 8ms	LK.1560D.001
	LCD COVER	60.N2802.004
	ANTENNA-AUX	50.N2802.002
	ANTENNA-MAIN	50.N2802.003
	ANTENNA-MAIN+MIMO	50.N2802.004
	LCD BEZEL FOR W/ CCD F	60.N2802.005
	LCD CABLE FOR W/ CCD F	50.N3202.001
	LCD BRACKET R&L FOR LCD	50.N2802.005
	INVERTER	19.N2802.001

CATEGORY	Description	AcerPN
	ASSY LCD MODULE 15.6 IN. WXGA GLARE W/ ANTENNA*2, W/O CCD	6M.N3202.001
	LCD AUO 15.6" WXGA Glare B156XW01-V0 LF 220nit 8ms	LK.15605.001
	CCFL LCD AUO 15.6"W WXGA Glare B156XW01 V0 1A LF 220nit 8ms 500:1	LK.15605.002
	CCFL LCD SAMSUNG 15.6"W WXGA Glare LTN156AT01-A01 LF 220nit 8ms 600:1	LK.15606.001
	CCFL LCD LPL 15.6" WXGA Glare LP156WH1-TLA1 LF 220nit 8ms 400:1	LK.15608.001
	LCD CMO 15.6" WXGA Glare N156B3-L02 LF 220nit 8ms	LK.1560D.001
	LCD COVER	60.N2802.004
	ANTENNA-AUX	50.N2802.002
	ANTENNA-MAIN	50.N2802.003
	ANTENNA-MAIN+MIMO	50.N2802.004
	LCD BEZEL FOR W/O CCD F	60.N3202.001
	LED CABLE FOR W/O CCD F	50.N3202.001
	LCD BRACKET R&L FOR LCD	33.N2802.004
	CAMERA 0.3	57.N2802.001

CATEGORY	Description	AcerPN
	ASSY LED MODULE 15.6 IN. WXGA GLARE W/ ANTENNA*3 W/O CCD	6M.N5502.001
	LCD AUO 15.6" WXGA Glare B156XW01-V0 LF 220nit 8ms	LK.15605.001
	CCFL LCD AUO 15.6"W WXGA Glare B156XW01 V0 1A LF 220nit 8ms 500:1	LK.15605.002
	CCFL LCD SAMSUNG 15.6"W WXGA Glare LTN156AT01-A01 LF 220nit 8ms 600:1	LK.15606.001
	CCFL LCD LPL 15.6" WXGA Glare LP156WH1-TLA1 LF 220nit 8ms 400:1	LK.15608.001
	LCD CMO 15.6" WXGA Glare N156B3-L02 LF 220nit 8ms	LK.1560D.001
	LCD COVER	60.N2802.004
	ANTENNA-AUX	50.N2802.002
	ANTENNA-MAIN	50.N2802.003
	ANTENNA-MAIN+MIMO	50.N2802.004
	LCD BEZEL FOR W/O CCD F	60.N3202.001
	LED CABLE FOR W/O CCD F	50.N3202.002
	LCD BRACKET R&L FOR LCD	33.N2802.005
<b>Mainboard</b>		
	Mainboard E627 ATI RS780 SB710 8132 V1.0 LF	MB.N6502.001
<b>Memory</b>		

CATEGORY	Description	AcerPN
	Memory NANYA SO-DIMM DDRII 667 1GB NT1GT64UH8D0FN-3C LF 64*16 0.07um	KN.1GB03.026
	Memory MICRON SO-DIMM DDRII 667 1GB MT8HTF12864HDY-667G1 LF 64*16 0.065um	KN.1GB04.010
	Memory ELPIDA SO-DIMM DDRII 667 1GB EBE11UE6ACUA-6E-E LF 64*16 0.065um	KN.1GB09.008
	Memory SAMSUNG SO-DIMM DDRII 667 1GB M470T2864EH3-CE6 LF 64*16 0.055um	KN.1GB0B.027
	Memory HYNIX SO-DIMM DDRII 667 1GB HYMP112S64CP6-Y5 LF	KN.1GB0G.012
	Memory HYNIX SO-DIMM DDRII 667 1GB HMP112S6EFR6C-Y5 LF 64*16 0.055um	KN.1GB0G.022
	Memory NANYA SO-DIMM DDRII 667 2GB NT2GT64U8HD0BN-3C LF 128*8 0.07um	KN.2GB03.011
	Memory MICRON SO-DIMM DDRII 667 2GB MT16HTF25664HY-667G1 LF 128*8 0.065um	KN.2GB04.010
	Memory ELPIDA SO-DIMM DDRII 667 2GB EBE21UE8ACUA-6E-E LF 128*8 0.07um	KN.2GB09.001
	Memory SAMSUNG SO-DIMM DDRII 667 2GB M470T5663EH3-CE6 LF 128*8 0.055um	KN.2GB0B.011
	Memory HYNIX SO-DIMM DDRII 667 2GB HYMP125S64CP8-Y5 LF	KN.2GB0G.004
	Memory HYNIX SO-DIMM DDRII 667 2GB HMP125S6EFR8C-Y5 LF 128*8 0.055um	KN.2GB0G.012
	<b>Heatsink</b>	
	THERMAL MODULE-AMD	60.N6502.001
	FAN	23.N2802.001
<b>Speaker</b>		
	SPEAKER R	23.N2802.002
	SPEAKER L	23.N2802.003
<b>Miscellaneous</b>		
	NAME PLATE-EME627	40.N6502.001
	NAME PLATE-EME427	40.N6502.002



# Model Definition and Configuration

Model	RO	Country	Acer Part No	Description	CPU
eME627-204G50Mi	EME A	Spain	LX.N6502.041	eME627-204G50Mi W7HP64EeTES1 UMACkk 2*2G/500_L/6L2.2/5R/ CB_bg_0.3D_N_HG_ES51	AATF20
eME627-203G25Mi	EME A	Holland	LX.N6502.039	eME627-203G25Mi W7HP64EeTNL1 UMACkk 2G+1G/250/6L2.2/5R/ CB_bg_0.3D_HG_NL11	AATF20
eME627-203G25Mi	EME A	Norway	LX.N6502.040	eME627-203G25Mi W7HP64EeTNO1 UMACkk 2G+1G/250/6L2.2/5R/ CB_bg_0.3D_HG_NO11	AATF20
eME627-203G25Mi	EME A	Denmark	LX.N6502.038	eME627-203G25Mi W7HP64EeTDK1 UMACkk 2G+1G/250/6L2.2/5R/ CB_bg_0.3D_HG_NO11	AATF20
eME627-203G25Mi	EME A	Denmark	LX.N6502.037	eME627-203G25Mi W7HP64EeTDK2 UMACkk 2G+1G/250/6L2.2/5R/ CB_bg_0.3D_HG_ENS1	AATF20
eME627-203G25Mi	EME A	Russia	LX.N6502.004	eME627-203G25Mi W7HP64RUeTRU1 UMACkk 2G+1G/250/6L2.2/5R/ CB_bg_0.3D_HG_RU11	AATF20
eME627-203G25Mi	EME A	Ukraine	LX.N6502.003	eME627-203G25Mi W7HP64RUeTUK1 UMACkk 2G+1G/250/6L2.2/5R/ CB_bg_0.3D_HG_RU61	AATF20
eME627-203G25Mi	EME A	Middle East	LX.N6502.013	eME627-203G25Mi EM W7HP64EMeTME4 UMACkk 2G+1G/ 250/6L2.2/5R/CB_bg_0.3D_HG_ES61	AATF20
eME627-203G25Mi	EME A	Middle East	LX.N6502.011	eME627-203G25Mi EM W7HP64EMeTME2 UMACkk 2G+1G/ 250/6L2.2/5R/CB_bg_0.3D_HG_ES61	AATF20
eME627-203G25Mi	EME A	Middle East	LX.N6502.012	eME627-203G25Mi EM W7HP64EMeTME2 UMACkk 2G+1G/ 250/6L2.2/5R/CB_bg_0.3D_HG_AR11	AATF20
eME627-203G25Mi	EME A	Middle East	LX.N6502.015	eME627-203G25Mi EM W7HP64EMeTME2 UMACkk 2G+1G/ 250/6L2.2/5R/CB_bg_0.3D_HG_AR21	AATF20
eME627-203G25Mi	EME A	Greece	LX.N6502.028	eME627-203G25Mi W7HP64EeTGR1 UMACkk 2G+1G/250/6L2.2/5R/ CB_bg_0.3D_HG_EL31	AATF20
eME627-203G25Mi	EME A	Eastern Europe	LX.N6502.033	eME627-203G25Mi W7HP64EeTEU7 UMACkk 2G+1G/250/6L2.2/5R/ CB_bg_0.3D_HG_ENQ1	AATF20
eME627-203G25Mi	EME A	Eastern Europe	LX.N6502.024	eME627-203G25Mi W7HP64EeTEU7 UMACkk 2G+1G/250/6L2.2/5R/ CB_bg_0.3D_HG_SL11	AATF20
eME627-203G25Mi	EME A	Spain	LX.N6502.016	eME627-203G25Mi W7HP64EeTES1 UMACkk 2G+1G/250/6L2.2/5R/ CB_bg_0.3D_HG_ES51	AATF20

Model	RO	Country	Acer Part No	Description	CPU
eME627-203G25Mi	EME A	Luxembourg	LX.N6502.035	eME627-203G25Mi W7HP64EeTLU3 UMACKk 2G+1G/250/6L2.2/5R/CB_bg_0.3D_HG_IT41	AATF20
eME627-203G25Mi	EME A	Switzerland	LX.N6502.018	eME627-203G25Mi W7HP64EeTCH1 UMACKk 2G+1G/250/6L2.2/5R/CB_bg_0.3D_HG_IT41	AATF20
eME627-203G25Mi	EME A	Algeria	LX.N6502.008	eME627-203G25Mi EM W7HP64EMeTDZ1 UMACKk 2G+1G/250/6L2.2/5R/CB_bg_0.3D_HG_ES81	AATF20
eME627-203G25Mi	EME A	Middle East	LX.N6502.009	eME627-203G25Mi EM W7HP64EMeTME9 UMACKk 2G+1G/250/6L2.2/5R/CB_bg_0.3D_HG_ES81	AATF20
eME627-203G25Mi	EME A	South Africa	LX.N6502.006	eME627-203G25Mi EM W7HP64EMeTZA1 UMACKk 2G+1G/250/6L2.2/5R/CB_bg_0.3D_HG_ES81	AATF20
eME627-203G25Mi	EME A	Middle East	LX.N6502.014	eME627-203G25Mi EM W7HP64EMeTME3 UMACKk 2G+1G/250/6L2.2/5R/CB_bg_0.3D_HG_ES81	AATF20
eME627-203G25Mi	EME A	Austria	LX.N6502.034	eME627-203G25Mi W7HP64EeTAT1 UMACKk 2G+1G/250/6L2.2/5R/CB_bg_0.3D_HG_DE61	AATF20
eME627-203G25Mi	EME A	Germany	LX.N6502.030	eME627-203G25Mi W7HP64EeTDE1 UMACKk 2G+1G/250/6L2.2/5R/CB_bg_0.3D_HG_DE11	AATF20
eME627-203G25Mi	EME A	Italy	LX.N6502.019	eME627-203G25Mi W7HP64EeTIT1 UMACKk 2G+1G/250/6L2.2/5R/CB_bg_0.3D_HG_IT11	AATF20
eME627-203G25Mi	EME A	Belgium	LX.N6502.036	eME627-203G25Mi W7HP64EeTBE1 UMACKk 2G+1G/250/6L2.2/5R/CB_bg_0.3D_HG_NL11	AATF20
eME627-203G25Mi	EME A	Czech	LX.N6502.031	eME627-203G25Mi W7HP64EeTCZ2 UMACKk 2G+1G/250/6L2.2/5R/CB_bg_0.3D_HG_SK11	AATF20
eME627-203G25Mi	EME A	Sweden	LX.N6502.032	eME627-203G25Mi W7HP64EeTSE1 UMACKk 2G+1G/250/6L2.2/5R/CB_bg_0.3D_HG_FI11	AATF20
eME627-203G25Mi	EME A	Eastern Europe	LX.N6502.023	eME627-203G25Mi W7HP64EeTEU4 UMACKk 2G+1G/250/6L2.2/5R/CB_bg_0.3D_HG_SV21	AATF20
eME627-203G25Mi	EME A	Finland	LX.N6502.026	eME627-203G25Mi W7HP64EeTFI2 UMACKk 2G+1G/250/6L2.2/5R/CB_bg_0.3D_HG_FI11	AATF20
eME627-203G25Mi	EME A	Turkey	LX.N6502.005	eME627-203G25Mi EM W7HP64EMeTTR1 UMACKk 2G+1G/250/6L2.2/5R/CB_bg_0.3D_HG_TR31	AATF20
eME627-203G25Mi	EME A	Cyprus	LX.N6502.020	eME627-203G25Mi W7HP64EeTCY1 UMACKk 2G+1G/250/6L2.2/5R/CB_bg_0.3D_HG_ES61	AATF20
eME627-203G25Mi	EME A	UK	LX.N6502.017	eME627-203G25Mi W7HP64EeTGB1 UMACKk 2G+1G/250/6L2.2/5R/CB_bg_0.3D_HG_EN11	AATF20



Model	RO	Country	Acer Part No	Description	CPU
eME627-203G25Mi	EME A	South Africa	LX.N6502.007	eME627-203G25Mi EM W7HP64EMeTZA2 UMACkk 2G+1G/250/6L2.2/5R/CB_bg_0.3D_HG_ES61	AATF20
eME627-203G25Mi	EME A	Middle East	LX.N6502.010	eME627-203G25Mi EM W7HP64EMeTME6 UMACkk 2G+1G/250/6L2.2/5R/CB_bg_0.3D_HG_ES61	AATF20
eME627-203G25Mi	EME A	Eastern Europe	LX.N6502.022	eME627-203G25Mi W7HP64EeTEU5 UMACkk 2G+1G/250/6L2.2/5R/CB_bg_0.3D_HG_RO11	AATF20
eME627-203G25Mi	EME A	Eastern Europe	LX.N6502.025	eME627-203G25Mi W7HP64EeTEU5 UMACkk 2G+1G/250/6L2.2/5R/CB_bg_0.3D_HG_PL71	AATF20
eME627-203G25Mi	EME A	Poland	LX.N6502.029	eME627-203G25Mi W7HP64EeTPL1 UMACkk 2G+1G/250/6L2.2/5R/CB_bg_0.3D_HG_PL11	AATF20
eME627-203G25Mi	EME A	Portugal	LX.N6502.027	eME627-203G25Mi W7HP64EeTPT1 UMACkk 2G+1G/250/6L2.2/5R/CB_bg_0.3D_HG_PT11	AATF20
eME627-203G25Mi	EME A	Hungary	LX.N6502.021	eME627-203G25Mi W7HP64EeTHU1 UMACkk 2G+1G/250/6L2.2/5R/CB_bg_0.3D_HG_HU11	AATF20
eME627-203G25Mi	EME A	France	LX.N6502.002	eME627-203G25Mi W7HP64EeTFR1 UMACkk 2G+1G/250/6L2.2/5R/CB_bg_0.3D_HG_FR21	AATF20
eME627-202G25Mi	EME A	UK	LX.N6502.001	eME627-202G25Mi W7HP64EeTGB1 UMACkk 1*2G/250/6L2.2/5R/CB_bg_0.3D_HG_EN11	AATF20
eME627-202G16Mi	AAP	Australia/ New Zealand	LX.N650Y.005	eME627-202G16Mi VHB32eTAU1 UMACkk 1*2G/160/6L2.2/5R/CB_bg_0.3D_HG_EN12	AATF20
eME627-202G16Mi	AAP	Australia/ New Zealand	LX.N650X.009	eME627-202G16Mi VHP32eTAU1 UMACkk 1*2G/160/6L2.2/5R/CB_bg_0.3D_HG_EN13	AATF20
eME627-202G25Mi	AAP	Australia/ New Zealand	LX.N650Y.004	eME627-202G25Mi VHB32eTAU1 UMACkk 1*2G/250/6L2.2/5R/CB_bg_0.3D_HG_EN12	AATF20
eME627-201G16Mi	AAP	Australia/ New Zealand	LX.N650Y.003	eME627-201G16Mi VHB32eTAU1 UMACkk 1*1G/160/6L2.2/5R/CB_bg_0.3D_HG_EN12	AATF20
eME627-6C4G25Mi	AAP	Australia/ New Zealand	LX.N650X.008	eME627-6C4G25Mi VHP32eTAU1 UMACkk 2*2G/250/6L2.2/5R/CB_bg_0.3D_HG_EN13	AATK42
eME627-6C2G25Mi	AAP	Australia/ New Zealand	LX.N650X.005	eME627-6C2G25Mi VHP32eTAU1 UMACkk 1*2G/250/6L2.2/5R/CB_bg_0.3D_HG_EN13	AATK42
eME627-202G32Mi	AAP	Australia/ New Zealand	LX.N650X.003	eME627-202G32Mi VHP32eTAU1 UMACkk 1*2G/320/6L2.2/5R/CB_bg_0.3D_HG_EN13	AATF20
eME627-6C4G32Mi	AAP	Australia/ New Zealand	LX.N650X.007	eME627-6C4G32Mi VHP32eTAU1 UMACkk 2*2G/320/6L2.2/5R/CB_bg_0.3D_HG_EN13	AATK42

Model	RO	Country	Acer Part No	Description	CPU
eME627-6C2G32Mi	AAP	Australia/ New Zealand	LX.N650X.004	eME627-6C2G32Mi VHP32eTAU1 UMACKk 1*2G/320/6L2.2/5R/ CB_bg_0.3D_HG_EN13	AATK42
eME627-202G25Mi	AAP	Australia/ New Zealand	LX.N650X.006	eME627-202G25Mi VHP32eTAU1 UMACKk 1*2G/250/6L2.2/5R/ CB_bg_0.3D_HG_EN13	AATF20
eME627-204G16Mi	AAP	Australia/ New Zealand	LX.N650X.002	eME627-204G16Mi VHP32eTAU1 UMACKk 2*2G/160/6L2.2/5R/ CB_bg_0.3D_HG_EN13	AATF20
eME627-204G25Mi	AAP	Australia/ New Zealand	LX.N650X.001	eME627-204G25Mi VHP32eTAU1 UMACKk 2*2G/250/6L2.2/5R/ CB_bg_0.3D_HG_EN13	AATF20
eME627-6C1G16Mi	AAP	India	LX.N650C.002	eME627-6C1G16Mi LIMPUSelN1 UMACKk 1*1G/160/6L2.2/5R/ CB_bg_0.3D_HG_EN11	AATK42
eME627-6C2G32Mi	AAP	India	LX.N650C.001	eME627-6C2G32Mi LIMPUSelN1 UMACKk 1*2G/320/6L2.2/5R/ CB_bg_0.3D_HG_EN11	AATK42
eME627-6C2G25Mi	AAP	India	LX.N650C.003	eME627-6C2G25Mi LIMPUSelN1 UMACKk 1*2G/250/6L2.2/5R/ CB_bg_0.3D_HG_EN11	AATK42
eME627-201G16Mi	AAP	India	LX.N650C.006	eME627-201G16Mi LIMPUSelN1 UMACKk 1*1G/160/6L2.2/5R/ CB_bg_0.3D_HG_EN11	AATF20
eME627-202G25Mi	AAP	India	LX.N650C.004	eME627-202G25Mi LIMPUSelN1 UMACKk 1*2G/250/6L2.2/5R/ CB_bg_0.3D_HG_EN11	AATF20
eME627-201G25Mi	AAP	India	LX.N650C.005	eME627-201G25Mi LIMPUSelN1 UMACKk 1*1G/250/6L2.2/5R/ CB_bg_0.3D_HG_EN11	AATF20
eME627-6C4G32Mi	AAP	Australia/ New Zealand	LX.N650Y.002	eME627-6C4G32Mi VHB32eTAU1 UMACKk 2*2G/320/6L2.2/5R/ CB_bg_0.3D_HG_EN12	AATK42
eME627-202G16Mi	PA	USA	LX.N650Y.001	eME627-202G16Mi VHB32eTUS1 UMACKk 1*2G/160/6L2.2/5R/ CB_bg_0.3D_HG_EN31	AATF20
eME627-202G16Mi	WW	WW	S2.N650Y.001	eME627-202G16Mi VHB32eWW1 UMACKk 2*1G/160/6L2.2/5R/ CB_bg_0.3D_HG_EN13	AATF20
eME627-312G16Mi	PA	Canada	LX.N6402.009	eME627-312G16Mi W7HP64eTCA2 UMAKk 2*1G/160/6L2.2/5R/ CB_bg_HG_FR84	AAL310
eME627-312G25Mi	PA	USA	LX.N6402.004	eME627-312G25Mi W7HP64eTUS1 UMAKk 2*1G/250/6L2.2/5R/ CB_bg_HG_FRB1	AAL310
eME627-312G16Mi	PA	USA	LX.N6402.006	eME627-312G16Mi W7HP64eTUS1 UMAKk 2*1G/160/6L2.2/5R/ CB_bg_HG_FRB1	AAL310
eME627-202G16Mi	PA	USA	LX.N6402.008	eME627-202G16Mi W7HP64eTUS1 UMAKk 2*1G/160/6L2.2/5R/ CB_bg_HG_FRB1	AATF20

Model	RO	Country	Acer Part No	Description	CPU
eME627-312G25Mi	PA	Canada	LX.N6402.005	eME627-312G25Mi W7HP64eTCA2 UMAKk 2*1G/250/6L2.2/5R/ CB_bg_HG_FR81	AAL310
eME627-312G16Mi	PA	Canada	LX.N6402.007	eME627-312G16Mi W7HP64eTCA2 UMAKk 2*1G/160/6L2.2/5R/ CB_bg_HG_FR81	AAL310
eME627-202G16Mi	PA	Canada	LX.N6402.001	eME627-202G16Mi W7HP64eTCA2 UMAKk 2*1G/160/6L2.2/5R/ CB_bg_HG_FR81	AATF20
eME627-313G16Mi	PA	Canada	LX.N6402.003	eME627-313G16Mi W7HP64eTCA2 UMAKk 2G+1G/160/6L2.2/5R/ CB_bg_HG_FR81	AAL310
eME627-313G16Mi	PA	USA	LX.N6402.002	eME627-313G16Mi W7HP64eTUS1 UMAKk 2G+1G/160/6L2.2/5R/ CB_bg_HG_FRB1	AAL310
eME627-201G25Mi	AAP	Australia/ New Zealand	LX.N640Y.001	eME627-201G25Mi VHB32eTAU1 UMAKk 1*1G/250/6L2.2/5R/ CB_bg_HG_EN12	AATF20
eME627-201G16Mi	AAP	Australia/ New Zealand	LX.N640Y.002	eME627-201G16Mi VHB32eTAU1 UMAKk 1*1G/160/6L2.2/5R/ CB_bg_HG_EN12	AATF20
eME627-202G16Mi	WW	WW	S2.N640X.001	eME627-202G16Mi VHP32eWW1 UMAKk 2*1G/160/6L2.2/5R/ CB_bg_HG_EN12	AATF20

Model	LCD	VGA Chip	VRAM 1	Memory 1	Memory 2
eME627-204G50Mi	N15.6WXGAG	UMA	N	SO2GBII6	SO2GBII6
eME627-203G25Mi	N15.6WXGAG	UMA	N	SO2GBII6	SO1GBII6
eME627-203G25Mi	N15.6WXGAG	UMA	N	SO2GBII6	SO1GBII6
eME627-203G25Mi	N15.6WXGAG	UMA	N	SO2GBII6	SO1GBII6
eME627-203G25Mi	N15.6WXGAG	UMA	N	SO2GBII6	SO1GBII6
eME627-203G25Mi	N15.6WXGAG	UMA	N	SO2GBII6	SO1GBII6
eME627-203G25Mi	N15.6WXGAG	UMA	N	SO2GBII6	SO1GBII6
eME627-203G25Mi	N15.6WXGAG	UMA	N	SO2GBII6	SO1GBII6
eME627-203G25Mi	N15.6WXGAG	UMA	N	SO2GBII6	SO1GBII6
eME627-203G25Mi	N15.6WXGAG	UMA	N	SO2GBII6	SO1GBII6
eME627-203G25Mi	N15.6WXGAG	UMA	N	SO2GBII6	SO1GBII6
eME627-203G25Mi	N15.6WXGAG	UMA	N	SO2GBII6	SO1GBII6
eME627-203G25Mi	N15.6WXGAG	UMA	N	SO2GBII6	SO1GBII6
eME627-203G25Mi	N15.6WXGAG	UMA	N	SO2GBII6	SO1GBII6
eME627-203G25Mi	N15.6WXGAG	UMA	N	SO2GBII6	SO1GBII6
eME627-203G25Mi	N15.6WXGAG	UMA	N	SO2GBII6	SO1GBII6
eME627-203G25Mi	N15.6WXGAG	UMA	N	SO2GBII6	SO1GBII6
eME627-203G25Mi	N15.6WXGAG	UMA	N	SO2GBII6	SO1GBII6
eME627-203G25Mi	N15.6WXGAG	UMA	N	SO2GBII6	SO1GBII6
eME627-203G25Mi	N15.6WXGAG	UMA	N	SO2GBII6	SO1GBII6
eME627-203G25Mi	N15.6WXGAG	UMA	N	SO2GBII6	SO1GBII6
eME627-203G25Mi	N15.6WXGAG	UMA	N	SO2GBII6	SO1GBII6

Model	LCD	VGA Chip	VRAM 1	Memory 1	Memory 2
eME627-203G25Mi	N15.6WXGAG	UMA	N	SO2GBII6	SO1GBII6
eME627-203G25Mi	N15.6WXGAG	UMA	N	SO2GBII6	SO1GBII6
eME627-203G25Mi	N15.6WXGAG	UMA	N	SO2GBII6	SO1GBII6
eME627-203G25Mi	N15.6WXGAG	UMA	N	SO2GBII6	SO1GBII6
eME627-203G25Mi	N15.6WXGAG	UMA	N	SO2GBII6	SO1GBII6
eME627-203G25Mi	N15.6WXGAG	UMA	N	SO2GBII6	SO1GBII6
eME627-203G25Mi	N15.6WXGAG	UMA	N	SO2GBII6	SO1GBII6
eME627-203G25Mi	N15.6WXGAG	UMA	N	SO2GBII6	SO1GBII6
eME627-203G25Mi	N15.6WXGAG	UMA	N	SO2GBII6	SO1GBII6
eME627-203G25Mi	N15.6WXGAG	UMA	N	SO2GBII6	SO1GBII6
eME627-203G25Mi	N15.6WXGAG	UMA	N	SO2GBII6	SO1GBII6
eME627-203G25Mi	N15.6WXGAG	UMA	N	SO2GBII6	SO1GBII6
eME627-203G25Mi	N15.6WXGAG	UMA	N	SO2GBII6	SO1GBII6
eME627-203G25Mi	N15.6WXGAG	UMA	N	SO2GBII6	SO1GBII6
eME627-203G25Mi	N15.6WXGAG	UMA	N	SO2GBII6	SO1GBII6
eME627-203G25Mi	N15.6WXGAG	UMA	N	SO2GBII6	SO1GBII6
eME627-203G25Mi	N15.6WXGAG	UMA	N	SO2GBII6	SO1GBII6
eME627-203G25Mi	N15.6WXGAG	UMA	N	SO2GBII6	SO1GBII6
eME627-203G25Mi	N15.6WXGAG	UMA	N	SO2GBII6	SO1GBII6
eME627-203G25Mi	N15.6WXGAG	UMA	N	SO2GBII6	SO1GBII6
eME627-202G25Mi	N15.6WXGAG	UMA	N	SO2GBII6	N
eME627-202G16Mi	N15.6WXGAG	UMA	N	SO2GBII6	N
eME627-202G16Mi	N15.6WXGAG	UMA	N	SO2GBII6	N
eME627-202G25Mi	N15.6WXGAG	UMA	N	SO2GBII6	N
eME627-201G16Mi	N15.6WXGAG	UMA	N	SO1GBII6	N
eME627-6C4G25Mi	N15.6WXGAG	UMA	N	SO2GBII6	SO2GBII6
eME627-6C2G25Mi	N15.6WXGAG	UMA	N	SO2GBII6	N
eME627-202G32Mi	N15.6WXGAG	UMA	N	SO2GBII6	N
eME627-6C4G32Mi	N15.6WXGAG	UMA	N	SO2GBII6	SO2GBII6
eME627-6C2G32Mi	N15.6WXGAG	UMA	N	SO2GBII6	N
eME627-202G25Mi	N15.6WXGAG	UMA	N	SO2GBII6	N
eME627-204G16Mi	N15.6WXGAG	UMA	N	SO2GBII6	SO2GBII6
eME627-204G25Mi	N15.6WXGAG	UMA	N	SO2GBII6	SO2GBII6
eME627-6C1G16Mi	N15.6WXGAG	UMA	N	SO1GBII6	N
eME627-6C2G32Mi	N15.6WXGAG	UMA	N	SO2GBII6	N
eME627-6C2G25Mi	N15.6WXGAG	UMA	N	SO2GBII6	N
eME627-201G16Mi	N15.6WXGAG	UMA	N	SO1GBII6	N
eME627-202G25Mi	N15.6WXGAG	UMA	N	SO2GBII6	N
eME627-201G25Mi	N15.6WXGAG	UMA	N	SO1GBII6	N
eME627-6C4G32Mi	N15.6WXGAG	UMA	N	SO2GBII6	SO2GBII6
eME627-202G16Mi	N15.6WXGAG	UMA	N	SO2GBII6	N
eME627-202G16Mi	N15.6WXGAG	UMA	N	SO1GBII6	SO1GBII6

Model	LCD	VGA Chip	VRAM 1	Memory 1	Memory 2
eME627-312G16Mi	N15.6WXGAG	UMA	N	SO1GBII6	SO1GBII6
eME627-312G25Mi	N15.6WXGAG	UMA	N	SO1GBII6	SO1GBII6
eME627-312G16Mi	N15.6WXGAG	UMA	N	SO1GBII6	SO1GBII6
eME627-202G16Mi	N15.6WXGAG	UMA	N	SO1GBII6	SO1GBII6
eME627-312G25Mi	N15.6WXGAG	UMA	N	SO1GBII6	SO1GBII6
eME627-312G16Mi	N15.6WXGAG	UMA	N	SO1GBII6	SO1GBII6
eME627-202G16Mi	N15.6WXGAG	UMA	N	SO1GBII6	SO1GBII6
eME627-313G16Mi	N15.6WXGAG	UMA	N	SO2GBII6	SO1GBII6
eME627-313G16Mi	N15.6WXGAG	UMA	N	SO2GBII6	SO1GBII6
eME627-201G25Mi	N15.6WXGAG	UMA	N	SO1GBII6	N
eME627-201G16Mi	N15.6WXGAG	UMA	N	SO1GBII6	N
eME627-202G16Mi	N15.6WXGAG	UMA	N	SO1GBII6	SO1GBII6

Model	HDD 1(GB)	HDD 2(GB)	ODD	Media Processor	Extra SW1	Card Reader
eME627-204G50Mi	N500GB 5.4KS	N	NSM8XS	N	NIS	5 in 1-Build in
eME627-203G25Mi	N250GB 5.4KS	N	NSM8XS	N	NIS	5 in 1-Build in
eME627-203G25Mi	N250GB 5.4KS	N	NSM8XS	N	NIS	5 in 1-Build in
eME627-203G25Mi	N250GB 5.4KS	N	NSM8XS	N	NIS	5 in 1-Build in
eME627-203G25Mi	N250GB 5.4KS	N	NSM8XS	N	NIS	5 in 1-Build in
eME627-203G25Mi	N250GB 5.4KS	N	NSM8XS	N	NIS	5 in 1-Build in
eME627-203G25Mi	N250GB 5.4KS	N	NSM8XS	N	NIS	5 in 1-Build in
eME627-203G25Mi	N250GB 5.4KS	N	NSM8XS	N	NIS	5 in 1-Build in
eME627-203G25Mi	N250GB 5.4KS	N	NSM8XS	N	NIS	5 in 1-Build in
eME627-203G25Mi	N250GB 5.4KS	N	NSM8XS	N	NIS	5 in 1-Build in
eME627-203G25Mi	N250GB 5.4KS	N	NSM8XS	N	NIS	5 in 1-Build in
eME627-203G25Mi	N250GB 5.4KS	N	NSM8XS	N	NIS	5 in 1-Build in
eME627-203G25Mi	N250GB 5.4KS	N	NSM8XS	N	NIS	5 in 1-Build in
eME627-203G25Mi	N250GB 5.4KS	N	NSM8XS	N	NIS	5 in 1-Build in
eME627-203G25Mi	N250GB 5.4KS	N	NSM8XS	N	NIS	5 in 1-Build in



Model	HDD 1(GB)	HDD 2(GB)	ODD	Media Processor	Extra SW1	Card Reader
eME627-203G25Mi	N250GB 5.4KS	N	NSM8XS	N	NIS	5 in 1-Build in
eME627-202G25Mi	N250GB 5.4KS	N	NSM8XS	N	NIS	5 in 1-Build in
eME627-202G16Mi	N160GB 5.4KS	N	NSM8XS	N	NIS	5 in 1-Build in
eME627-202G16Mi	N160GB 5.4KS	N	NSM8XS	N	NIS	5 in 1-Build in
eME627-202G25Mi	N250GB 5.4KS	N	NSM8XS	N	NIS	5 in 1-Build in
eME627-201G16Mi	N160GB 5.4KS	N	NSM8XS	N	NIS	5 in 1-Build in
eME627-6C4G25Mi	N250GB 5.4KS	N	NSM8XS	N	NIS	5 in 1-Build in
eME627-6C2G25Mi	N250GB 5.4KS	N	NSM8XS	N	NIS	5 in 1-Build in
eME627-202G32Mi	N320GB 5.4KS	N	NSM8XS	N	NIS	5 in 1-Build in
eME627-6C4G32Mi	N320GB 5.4KS	N	NSM8XS	N	NIS	5 in 1-Build in
eME627-6C2G32Mi	N320GB 5.4KS	N	NSM8XS	N	NIS	5 in 1-Build in
eME627-202G25Mi	N250GB 5.4KS	N	NSM8XS	N	NIS	5 in 1-Build in
eME627-204G16Mi	N160GB 5.4KS	N	NSM8XS	N	NIS	5 in 1-Build in
eME627-204G25Mi	N250GB 5.4KS	N	NSM8XS	N	NIS	5 in 1-Build in
eME627-6C1G16Mi	N160GB 5.4KS	N	NSM8XS	N	N	5 in 1-Build in
eME627-6C2G32Mi	N320GB 5.4KS	N	NSM8XS	N	N	5 in 1-Build in
eME627-6C2G25Mi	N250GB 5.4KS	N	NSM8XS	N	N	5 in 1-Build in
eME627-201G16Mi	N160GB 5.4KS	N	NSM8XS	N	N	5 in 1-Build in
eME627-202G25Mi	N250GB 5.4KS	N	NSM8XS	N	N	5 in 1-Build in
eME627-201G25Mi	N250GB 5.4KS	N	NSM8XS	N	N	5 in 1-Build in
eME627-6C4G32Mi	N320GB 5.4KS	N	NSM8XS	N	NIS	5 in 1-Build in
eME627-202G16Mi	N160GB 5.4KS	N	NSM8XS	N	NIS	5 in 1-Build in
eME627-202G16Mi	N160GB 5.4KS	N	NSM8XS	N	NIS	5 in 1-Build in
eME627-312G16Mi	N160GB 5.4KS	N	NSM8XS	N	NIS	5 in 1-Build in





Model	Wireless LAN	Wireless LAN1	Bluetooth
eME627-203G25Mi	3rd WiFi BG	3rd WiFi BG	N
eME627-203G25Mi	3rd WiFi BG	3rd WiFi BG	N
eME627-203G25Mi	3rd WiFi BG	3rd WiFi BG	N
eME627-203G25Mi	3rd WiFi BG	3rd WiFi BG	N
eME627-203G25Mi	3rd WiFi BG	3rd WiFi BG	N
eME627-203G25Mi	3rd WiFi BG	3rd WiFi BG	N
eME627-203G25Mi	3rd WiFi BG	3rd WiFi BG	N
eME627-203G25Mi	3rd WiFi BG	3rd WiFi BG	N
eME627-203G25Mi	3rd WiFi BG	3rd WiFi BG	N
eME627-203G25Mi	3rd WiFi BG	3rd WiFi BG	N
eME627-203G25Mi	3rd WiFi BG	3rd WiFi BG	N
eME627-203G25Mi	3rd WiFi BG	3rd WiFi BG	N
eME627-203G25Mi	3rd WiFi BG	3rd WiFi BG	N
eME627-203G25Mi	3rd WiFi BG	3rd WiFi BG	N
eME627-203G25Mi	3rd WiFi BG	3rd WiFi BG	N
eME627-203G25Mi	3rd WiFi BG	3rd WiFi BG	N
eME627-203G25Mi	3rd WiFi BG	3rd WiFi BG	N
eME627-203G25Mi	3rd WiFi BG	3rd WiFi BG	N
eME627-203G25Mi	3rd WiFi BG	3rd WiFi BG	N
eME627-202G25Mi	3rd WiFi BG	3rd WiFi BG	N
eME627-202G16Mi	3rd WiFi BG	3rd WiFi BG	N
eME627-202G16Mi	3rd WiFi BG	3rd WiFi BG	N
eME627-202G25Mi	3rd WiFi BG	3rd WiFi BG	N
eME627-201G16Mi	3rd WiFi BG	3rd WiFi BG	N
eME627-6C4G25Mi	3rd WiFi BG	3rd WiFi BG	N
eME627-6C2G25Mi	3rd WiFi BG	3rd WiFi BG	N
eME627-202G32Mi	3rd WiFi BG	3rd WiFi BG	N
eME627-6C4G32Mi	3rd WiFi BG	3rd WiFi BG	N
eME627-6C2G32Mi	3rd WiFi BG	3rd WiFi BG	N
eME627-202G25Mi	3rd WiFi BG	3rd WiFi BG	N
eME627-204G16Mi	3rd WiFi BG	3rd WiFi BG	N
eME627-204G25Mi	3rd WiFi BG	3rd WiFi BG	N
eME627-6C1G16Mi	3rd WiFi BG	3rd WiFi BG	N
eME627-6C2G32Mi	3rd WiFi BG	3rd WiFi BG	N
eME627-6C2G25Mi	3rd WiFi BG	3rd WiFi BG	N
eME627-201G16Mi	3rd WiFi BG	3rd WiFi BG	N
eME627-202G25Mi	3rd WiFi BG	3rd WiFi BG	N
eME627-201G25Mi	3rd WiFi BG	3rd WiFi BG	N
eME627-6C4G32Mi	3rd WiFi BG	3rd WiFi BG	N
eME627-202G16Mi	3rd WiFi BG	3rd WiFi BG	N
eME627-202G16Mi	3rd WiFi BG	3rd WiFi BG	N

<b>Model</b>	<b>Wireless LAN</b>	<b>Wireless LAN1</b>	<b>Bluetooth</b>
eME627-312G16Mi	3rd WiFi BG	3rd WiFi BG	N
eME627-312G25Mi	3rd WiFi BG	3rd WiFi BG	N
eME627-312G16Mi	3rd WiFi BG	3rd WiFi BG	N
eME627-202G16Mi	3rd WiFi BG	3rd WiFi BG	N
eME627-312G25Mi	3rd WiFi BG	3rd WiFi BG	N
eME627-312G16Mi	3rd WiFi BG	3rd WiFi BG	N
eME627-202G16Mi	3rd WiFi BG	3rd WiFi BG	N
eME627-313G16Mi	3rd WiFi BG	3rd WiFi BG	N
eME627-313G16Mi	3rd WiFi BG	3rd WiFi BG	N
eME627-201G25Mi	3rd WiFi BG	3rd WiFi BG	N
eME627-201G16Mi	3rd WiFi BG	3rd WiFi BG	N
eME627-202G16Mi	3rd WiFi BG	3rd WiFi BG	N



# Test Compatible Components

---

This computer's compatibility is tested and verified by Acer's internal testing department. All of its system functions are tested under Windows® XP Home, Windows® XP Pro environment.

Refer to the following lists for components, adapter cards, and peripherals which have passed these tests. Regarding configuration, combination and test procedures, please refer to the eMachines E627 Compatibility Test Report released by the Acer Mobile System Testing Department.

# Microsoft® Windows® Vista Environment Test

Vendor	Type	Description
Adapter		
DELTA	65W	Adapter DELTA 65W 19V 1.7x5.5x11 Yellow ADP-65JH DB A, LV5 LED LF
LITE-ON	65W	Adapter LITE-ON 65W 19V 1.7x5.5x11 Yellow PA-1650-22AC LV5 LED LF
HIPRO	65W	Adapter HIPRO 65W 19V 1.7x5.5x11 Yellow HP-A0652R3B 1LF, LV5 LED LF
Battery		
SANYO	6CELL2.2	Battery SANYO AS-2009A Li-Ion 3S2P SANYO 6 cell 4400mAh Main COMMON 2.2Ah(A)
SONY	6CELL2.2	Battery SONY AS-2009A Li-Ion 3S2P SONY 6 cell 4400mAh Main COMMON 2.2Ah(G6F)
PANASONIC	6CELL2.2	Battery PANASONIC AS-2009A Li-Ion 3S2P PANASONIC 6 cell 4400mAh Main COMMON 2.2Ah(CG )
SAMSUNG	6CELL2.2	Battery SAMSUNG AS-2009A Li-Ion 3S2P SAMSUNG 6 cell 4400mAh Main COMMON 2.2Ah(F)
SIMPLO	6CELL2.2	Battery SIMPLO AS-2009A Li-Ion 3S2P PANASONIC 6 cell 4400mAh Main COMMON Panasonic 2.2Ah ( CG )
SIMPLO	6CELL2.2	Battery SIMPLO AS-2009A Li-Ion 3S2P LGC 6 cell 4400mAh Main COMMON LGC 2.2Ah(S3 )
SIMPLO	6CELL2.2	Battery SIMPLO AS-2009A Li-Ion 3S2P SAMSUNG 6 cell 4400mAh Main COMMON SDI 2.2Ah(F)
CPU		
AMD	AATF20	CPU AMD Athlon TF20 PGA 1.6G 512K 638 15W G2
AMD	AATK42	CPU AMD AthlonX2 TK42 1.6G 1M 638 20W G2
HDD		
SEAGATE	N160GB5.4KS	HDD SEAGATE 2.5" 5400rpm 160GB ST9160310AS Crockett SATA LF F/W:0303
TOSHIBA	N160GB5.4KS	HDD TOSHIBA 2.5" 5400rpm 160GB MK1655GSX Libra SATA LF F/W: FG011J
HGST	N160GB5.4KS	HDD HGST 2.5" 5400rpm 160GB HTS543216L9A300 Falcon-B SATA LF F/W:C40C
WD	N160GB5.4KS	HDD WD 2.5" 5400rpm 160GB WD1600BEVT-22ZCTO ML160 SATA LF F/W:11.01A11
SEAGATE	N250GB5.4KS	HDD SEAGATE 2.5" 5400rpm 250GB ST9250315AS Wyatt SATA LF F/W:0001SDM1
TOSHIBA	N250GB5.4KS	HDD TOSHIBA 2.5" 5400rpm 250GB MK2555GSX Libra SATA LF F/W:FG001J
HGST	N250GB5.4KS	HDD HGST 2.5" 5400rpm 250GB HTS545025B9A300 Panther B SATA LF F/W:C60F
WD	N250GB5.4KS	HDD WD 2.5" 5400rpm 250GB WD2500BEVT-22ZCTO ML160 SATA LF F/W:11.01A11
SEAGATE	N320GB5.4KS	HDD SEAGATE 2.5" 5400rpm 320GB ST9320320AS Crockett SATA LF F/W:0303
TOSHIBA	N320GB5.4KS	HDD TOSHIBA 2.5" 5400rpm 320GB MK3255GSX Libra SATA LF F/W:FG011J

Vendor	Type	Description
HGST	N320GB5.4KS	HDD HGST 2.5" 5400rpm 320GB HTS545032B9A300 Panther B SATA LF F/W: C60F
WD	N320GB5.4KS	HDD WD 2.5" 5400rpm 320GB WD3200BEVT-22ZCT0 ML160 SATA LF F/W:11.01A11
SEAGATE	N500GB5.4KS	HDD SEAGATE 2.5" 5400rpm 500GB ST9500325AS Wyatt SATA LF F/W:0001SDM1
HGST	N500GB5.4KS	HDD HGST 2.5" 5400rpm 500GB HTS545050B9A300 Panther B SATA LF F/W:C60F
WD	N500GB5.4KS	HDD WD 2.5" 5400rpm 500GB WD5000BEVT-22ZAT0 ML250 SATA LF F/W:01.01A01
LCD		
AUO	N15.6WXGAG	LCD AUO 15.6" WXGA Glare B156XW01-V0 LF 220nit 8ms
AUO	N15.6WXGAG	CCFL LCD AUO 15.6"W WXGA Glare B156XW01 V0 1A LF 220nit 8ms 500:1
SAMSUNG	N15.6WXGAG	CCFL LCD SAMSUNG 15.6"W WXGA Glare LTN156AT01-A01 LF 220nit 8ms 600:1
LPL	N15.6WXGAG	CCFL LCD LPL 15.6" WXGA Glare LP156WH1-TLA1 LF 220nit 8ms 400:1
CMO	N15.6WXGAG	LCD CMO 15.6" WXGA Glare N156B3-L02 LF 220nit 8ms
MEM		
NANYA	SO1GBII6	Memory NANYA SO-DIMM DDRII 667 1GB NT1GT64UH8D0FN-3C LF 64*16 0.07um
MICRON	SO1GBII6	Memory MICRON SO-DIMM DDRII 667 1GB MT8HTF12864HDY-667G1 LF 64*16 0.065um
SAMSUNG	SO1GBII6	Memory SAMSUNG SO-DIMM DDRII 667 1GB M470T2864EH3-CE6 LF 64*16 0.055um
HYNIX	SO1GBII6	Memory HYNIX SO-DIMM DDRII 667 1GB HYMP112S64CP6-Y5 LF
HYNIX	SO1GBII6	Memory HYNIX SO-DIMM DDRII 667 1GB HMP112S6EFR6C-Y5 LF 64*16 0.055um
NANYA	SO2GBII6	Memory NANYA SO-DIMM DDRII 667 2GB NT2GT64U8HD0BN-3C LF 128*8 0.07um
MICRON	SO2GBII6	Memory MICRON SO-DIMM DDRII 667 2GB MT16HTF25664HY-667G1 LF 128*8 0.065um
SAMSUNG	SO2GBII6	Memory SAMSUNG SO-DIMM DDRII 667 2GB M470T5663EH3-CE6 LF 128*8 0.055um
HYNIX	SO2GBII6	Memory HYNIX SO-DIMM DDRII 667 2GB HYMP125S64CP8-Y5 LF
HYNIX	SO2GBII6	Memory HYNIX SO-DIMM DDRII 667 2GB HMP125S6EFR8C-Y5 LF 128*8 0.055um
ODD		
TOSHIBA	NSM8XS	ODD TOSHIBA Super-Multi DRIVE 12.7mm Tray DL 8X TS-L633B LF W/O bezel SATA
PANASONIC	NSM8XS	ODD PANASONIC Super-Multi DRIVE 12.7mm Tray DL 8X UJ880A LF W/O bezel SATA
HLDS	NSM8XS	ODD HLDS Super-Multi DRIVE 12.7mm Tray DL 8X GT20N LF W/O bezel SATA
SONY	NSM8XS	ODD SONY Super-Multi DRIVE 12.7mm Tray DL 8X AD-7580S LF W/O bezel SATA



Vendor	Type	Description
PLDS	NSM8XS	ODD PLDS Super-Multi DRIVE 12.7mm Tray DL 8X DS-8A3S LF W/O bezel SATA
VGA Chip		
None	UMA	UMA (AMD)
NB Chipset		
AMD	AMDRS780MN	AMDRS780MN
SB Chipset		
ATI	AMDSB710	AMDSB710
Keyboard		
eMACHINES	EM-7T	Keyboard eMACHINES EM-7T HM50/70 Internal 17 Standard Black
LAN		
Atheros	AR8132L	Atheros AR8132L
WiFi Antenna		
WNC	PIFA	PIFA
Audio Codec		
Realtek	ALC272X	Realtek Audio Codec ALC272X
A cover		
Quanta Wistron	Normal wi IMR	Normal wi IMR
B cover		
	Mirror w/Camera	Mirror w/Camera
Camera		
Suyin	0.3M DV	Suyin 0.3M DV Camellia_2G
Chicony	0.3M DV	Chicony 0.3M DV Calla_2G
Card Reader		
	5 in 1-Build in	5 in 1-Build in MS, MS Pro, SD, SC, XD
Software		
	NIS	Antivirus application NIS
Wireless LAN		
Foxconn	3rd WiFi BG	Foxconn FOX_ATH_XB63 Foxconn Atheros XB63 minicard b/g
Foxconn	3rd WiFi BG	Foxconn Wireless LAN Broadcom 4312 minicard b/g

# Online Support Information

---

This section describes online technical support services available to help you repair your Acer Systems.

If you are a distributor, dealer, ASP or TPM, please refer your technical queries to your local Acer branch office. Acer Branch Offices and Regional Business Units may access our website. However some information sources will require a user i.d. and password. These can be obtained directly from Acer CSD Taiwan.

Acer's Website offers you convenient and valuable support resources whenever you need them.

In the Technical Information section you can download information on all of Acer's Notebook, Desktop and Server models including:

- Service guides for all models
- User's manuals
- Training materials
- Bios updates
- Software utilities
- Spare parts lists
- TABs (Technical Announcement Bulletin)

For these purposes, we have included an Acrobat File to facilitate the problem-free downloading of our technical material.

Also contained on this website are:

- Detailed information on Acer's International Traveler's Warranty (ITW)
- Returned material authorization procedures
- An overview of all the support services we offer, accompanied by a list of telephone, fax and email contacts for all your technical queries.

We are always looking for ways to optimize and improve our services, so if you have any suggestions or comments, please do not hesitate to communicate these to us.



---

## A

AFLASH Utility 33

Antennas

Removing 86

Replacing 89

## B

Battery

Replacing 119

Battery Pack

Removing 44

BIOS

ROM type 18

vendor 17

Version 17

BIOS Utility 25–33

Boot 31

Exit 32

Navigating 25

Onboard Device Configuration 29

Save and Exit 32

Security 28

System Security 32

Board Layout

Top View 139

brightness

hotkeys 14

## C

Camera Module

Removing 81

Replacing 94

caps lock

on indicator 6, 10

Common Problems 122

computer

on indicator 6, 10

CPU

Removing 78

Replacing 97

CPU Fan

Removing 76

Replacing 98

## D

DIMM Modules

Removing 49

Replacing 116

Display 4

display

hotkeys 14

## E

EasyTouch Failure 132

Euro 15

External Module Disassembly

Flowchart 43

## F

Features 1

Flash Utility 33

FPC Cable

Removing 84

FRU (Field Replaceable Unit) List 145

## H

Hard Disk Drive

Removing 52

Replacing 114

HDTV Switch Failure 133

Hibernation mode

hotkey 14

Hot Keys 12

## I

Indicators 10

Intermittent Problems 134

Internal Speaker Failure 126

## J

Jumper and Connector Locations 139

## K

Keyboard

Removing 56

Replacing 113

Keyboard Failure 125

## L

LCD Bezel

---

- Removing 80
- Replacing 95
- LCD Brackets
  - Removing 84
  - Replacing 92
- LCD Cable
  - Replacing 92
- LCD Failure 125
- LCD Module
  - Removing 57
  - Replacing 108
- LCD Module Disassembly
  - Flowchart 79
- LCD Module Reassembly Procedure 89
- LCD Panel
  - Removing 82
  - Replacing 92
- Left Speaker Module
  - Removing 66
- Lower Covers
  - Removing 46
  - Replacing 117

## M

- Main Unit Disassembly
  - Flowchart 54
- Mainboard
  - Removing 72
  - Replacing 99
- media access
  - on indicator 6, 10
- Memory
  - Removing 49
  - Replacing 116
- Memory Check 122
- Model Definition 160

## N

- No Display Issue 123
- Notebook Manager
  - hotkey 14
- num lock
  - on indicator 6, 10

## O

- ODD Failure 129
- Online Support Information 177
- Optical Disk Drive
  - Replacing 117
- Optical Drive Module
  - Removing 47

## P

- Panel 5
  - Bottom 8
- PC Card 10
- Power Board
  - Removing 65
  - Replacing 104
- Power On Failure 122

## R

- Right Speaker Module
  - Removing 68
  - Replacing 102
- RTC Battery
  - Removing 73

## S

- SD Dummy Card
  - Removing 45
  - Replacing 118
- Speakers
  - Removing 66, 68
- speakers
  - hotkey 14
- Switch Cover
  - Removing 55
  - Replacing 114
- System
  - Block Diagram 4

## T

- Test Compatible Components 173
- Thermal Module
  - Removing 74
  - Replacing 98
- Thermal Unit Failure 132
- TouchPad
  - hotkey 14

---

- Removing 70
- TouchPad Bracket
  - Removing 70
  - Replacing 100
- TouchPad Failure 126
- Troubleshooting
  - Built-in KB Failure 125
  - EasyTouch Buttons 132
  - HDTV Switch 133
  - Internal Speakers 126
  - LCD Failure 125
  - No Display 123
  - ODD 129
  - Other Failures 133
  - Power On 122
  - Thermal Unit 132
  - TouchPad 126
  - WLAN 132

## U

- Undetermined Problems 134
- Upper Cover
  - Removing 61
  - Replacing 104
- utility
  - BIOS 25–33

## W

- Windows 2000 Environment Test 174
- Wireless Function Failure 132
- WLAN Module
  - Removing 50
  - Replacing 116

