

# Dell™ Latitude™ X200 Service Manual

## [Before You Begin](#)

[Preparing to Work Inside the Computer](#)

[Recommended Tools](#)

[Computer Orientation](#)

[Screw Identification](#)

## [System Components](#)

[Battery](#)

[Memory Module and Mini PCI Card](#)

[Memory Module](#)

[Mini PCI Card](#)

[Keyboard](#)

[Palm Rest](#)

[Hard Drive](#)

[Hinge Covers and Display Assembly](#)

[Hinge Covers](#)

[Display Assembly](#)

[Keyboard Tray](#)

[Reserve Battery](#)

[Speakers](#)

[Cooling Fan](#)

[System Board](#)

[Modem Daughter Card](#)

[Battery Latches](#)

[Flashing the BIOS](#)

[Pin Assignments for I/O Connectors](#)

[Pin Assignments for the Computer](#)

[Pin Assignments for the Media Base](#)

---

## **Notes, Notices, and Cautions**



**NOTE:** A NOTE indicates important information that helps you make better use of your computer.



**NOTICE:** A NOTICE indicates either potential damage to hardware or loss of data and tells you how to avoid the problem.



**CAUTION:** A CAUTION indicates a potential for property damage, personal injury, or death.

---

Trademarks used in this text: *Dell*, the *DELL* logo, *AccessDirect*, and *Latitude* are trademarks of Dell Computer Corporation.

Other trademarks and trade names may be used in this document to refer to either the entities claiming the marks and names or their products. Dell Computer Corporation disclaims any proprietary interest in trademarks and trade names other than its own.

**April 2002 Rev. A00**

[Back to Contents Page](#)

# Before You Begin

## Dell™ Latitude™ X200 Service Manual

- [Preparing to Work Inside the Computer](#)
  - [Recommended Tools](#)
  - [Computer Orientation](#)
  - [Screw Identification](#)
- 

## Preparing to Work Inside the Computer

 **CAUTION:** Before working inside your computer, read "**Safety and EMC Instructions: Portable Computers**" in your *System Information Guide*.

 **NOTICE:** Only a certified service technician should perform repairs on your computer. Damage due to servicing that is not authorized by Dell is not covered by your warranty.

 **NOTICE:** To avoid damaging the computer, perform the following steps before you begin working inside the computer.

1. Ensure that the work surface is flat and clean to prevent scratching the computer cover.
2. Save any work in progress and exit all open programs.
3. Turn off the computer and all attached devices.

 **NOTE:** Ensure that the computer is turned off and not in suspend or hibernate mode. If you cannot shut down the computer using the computer operating system, press and hold the power button for 4 seconds.

4. Ensure that the computer is undocked.

5. Disconnect the computer from the electrical outlet.
  6. To avoid possible damage to the system board, wait 10 to 20 seconds and then disconnect any attached devices.
  7. Disconnect all other external cables from the computer.
  8. Remove any installed PC Cards or plastic blanks from the PC Card slot.
  9. Close the display and turn the computer upside down on a flat work surface.
-  **NOTICE:** To avoid damaging the system board, you must remove the battery before you service the computer.
10. Remove the battery from the battery bay.
  11. To dissipate any static electricity while you work, use a wrist grounding strap or periodically touch an unpainted metal surface.
  12. Handle components and cards with care. Do not touch the components or contacts on a card. Hold a card by its edges or by its metal mounting bracket. Hold a component such as a microprocessor by its edges, not by its pins.
- 

## Recommended Tools

The procedures in this manual require the following tools:

- #1 magnetized Phillips screwdriver
  - ¼-inch flat-blade screwdriver
  - Small plastic scribe
- 

## Computer Orientation



1	back
2	right
3	front
4	left

## Screw Identification

When you are removing and replacing components, photocopy the placemat as a tool to lay out and keep track of the screws. The placemat provides the number of screws and their sizes.



**NOTICE:** When reinstalling a screw, you must use a screw of the correct diameter and length. Ensure that the screw is properly aligned with its corresponding hole, and avoid overtightening.

Keyboard:

(6 each)



Palm Rest:

(4 each)



Display Assembly:

(2 each)



Keyboard Tray:

(7 each)



**Hard Drive:**

(3 each)



**System Board:**

(4 each)



**Modem Daughter Card:**

(1 each)



**Cooling Fan:**

(4 each)



**Speaker:**

(1 each)







[Back to Contents Page](#)

# System Components

## Dell™ Latitude™ X200 Service Manual

- ➔ **NOTICE:** Only a certified service technician should perform repairs on your computer. Damage due to servicing that is not authorized by Dell is not covered by your warranty.
- ➔ **NOTICE:** Unless otherwise noted, each procedure in this manual assumes that a part can be replaced by performing the removal procedure in reverse order.

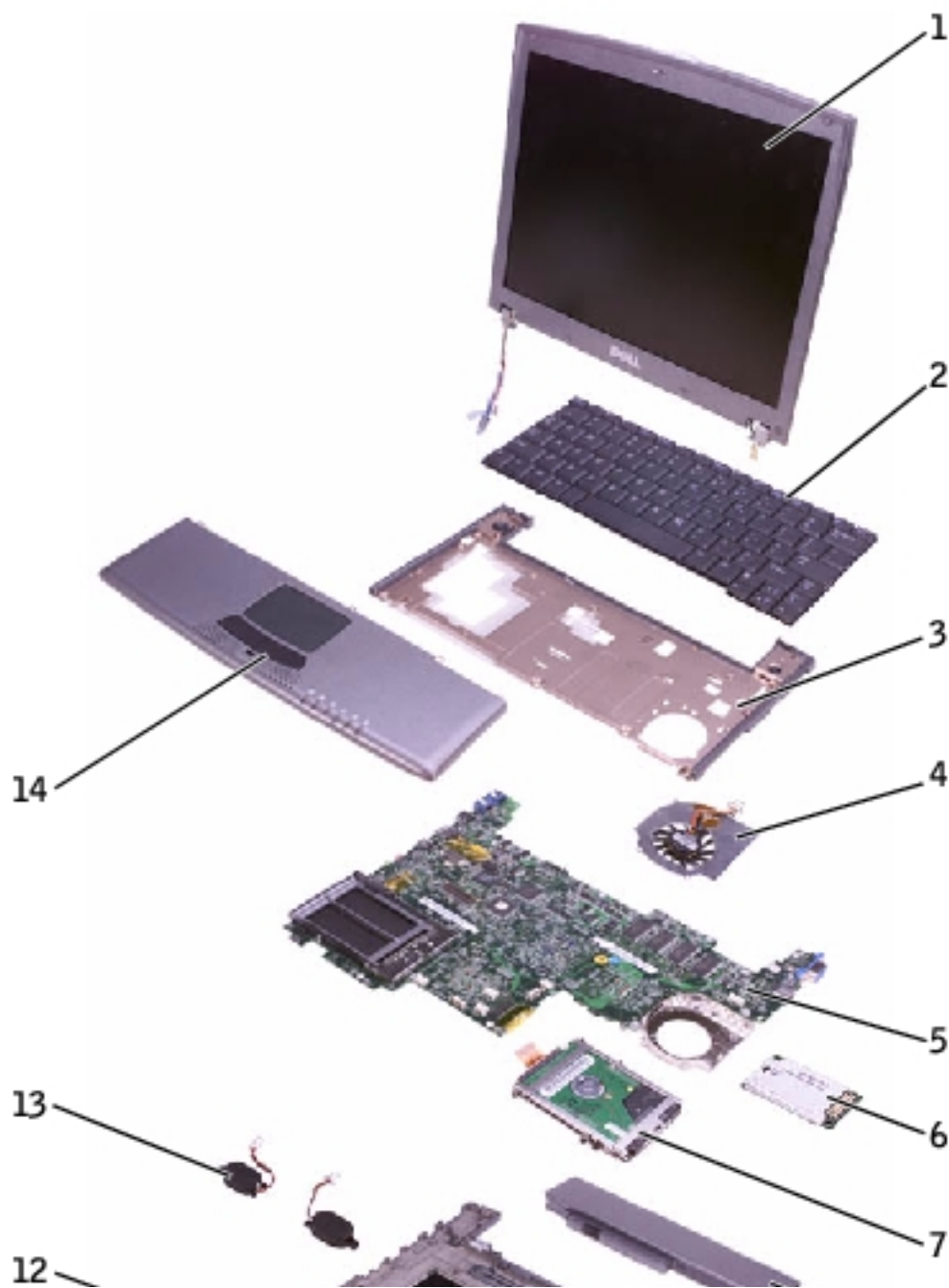

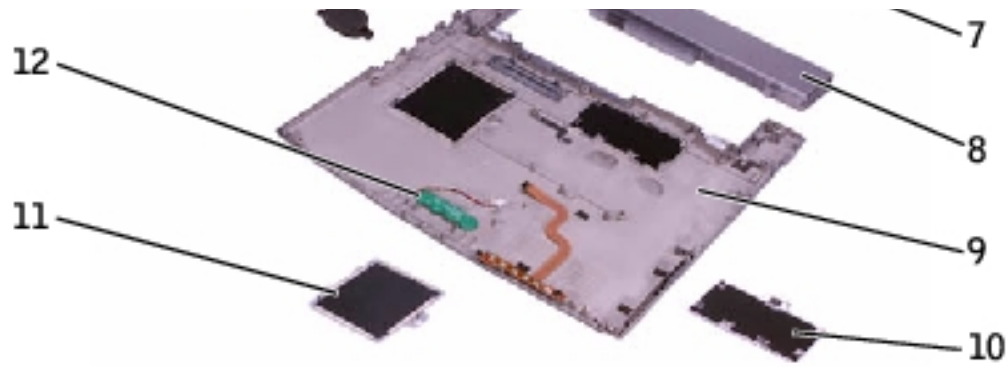

1	display	8	battery
2	keyboard	9	bottom case
3	keyboard tray	10	memory module cover
4	cooling fan	11	Mini PCI card cover
5	system board	12	reserve battery
6	modem daughter card	13	speakers (2)
7	hard drive	14	palm rest

---

[Back to Contents Page](#)

[Back to Contents Page](#)

# Battery

## Dell™ Latitude™ X200 Service Manual

### Removing the Battery

 **NOTICE:** If you choose to replace the battery with the computer in standby mode, you have up to 1 minute to complete the battery replacement before the computer shuts down and loses any unsaved data.

1. Ensure that the computer is turned off, suspended in a power management mode, or connected to an electrical outlet.
2. If the computer is docked, undock it.
3. Slide the battery lock latch on the bottom of the computer to the unlock position.
4. Slide and hold the battery latch release on the bottom of the computer, and then remove the battery from the bay.

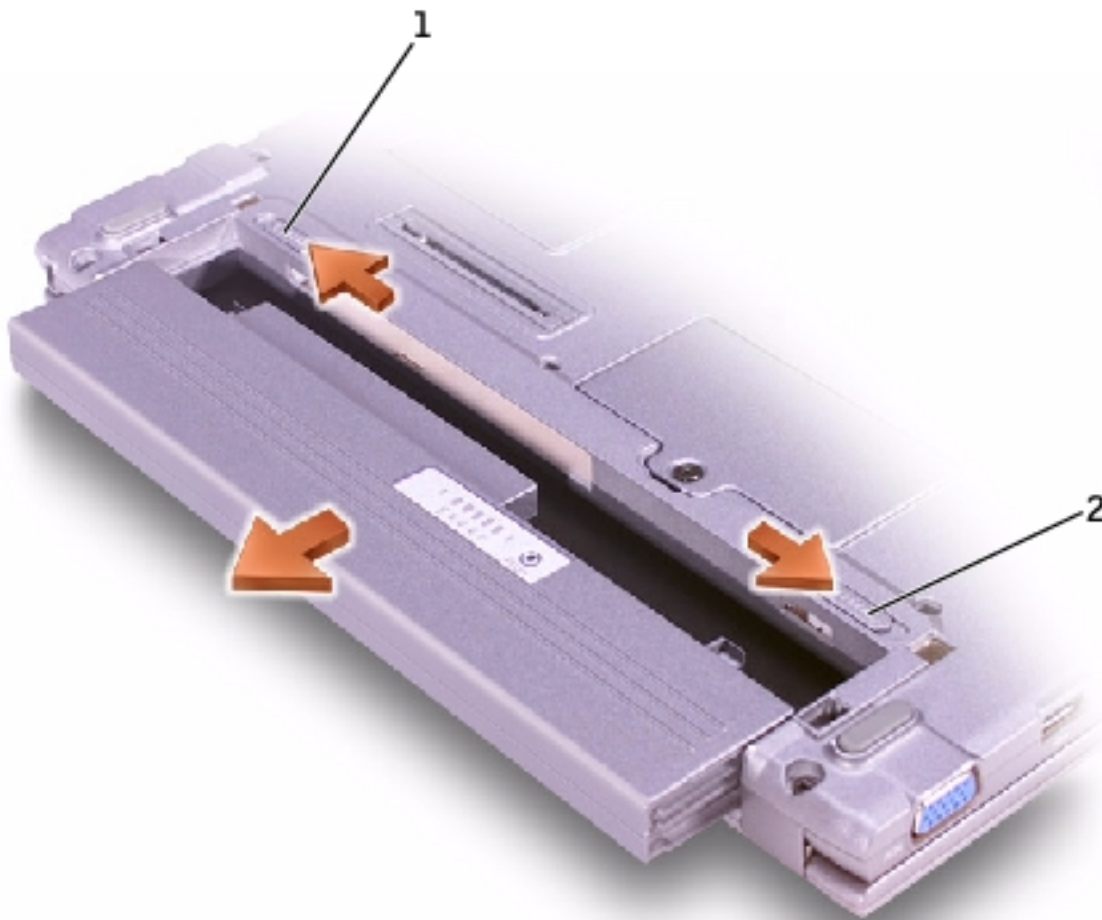

1	battery lock latch
2	battery latch release

## Replacing the Battery



**CAUTION:** Use only Dell™ battery modules that are approved for use with this computer. Use of other types may increase the risk of fire or explosion.

1. Slide the battery into the bay until the latch release clicks.
2. Slide the battery lock latch into the lock position.

[Back to Contents Page](#)

[Back to Contents Page](#)

# Memory Module and Mini PCI Card

## Dell™ Latitude™ X200 Service Manual

• [Memory Module](#)

• [Mini PCI Card](#)

---

## Memory Module

### Removing the Memory Module Cover

- ➔ **NOTICE:** Disconnect the computer and any attached devices from electrical outlets, and remove any installed batteries.
  - ➔ **NOTICE:** To avoid ESD, ground yourself by using a wrist grounding strap or by touching an unpainted metal surface on the computer.
  - ➔ **NOTICE:** Read "[Preparing to Work Inside the Computer](#)" before performing the following procedure.
1. If the computer is docked, undock it.
  2. Turn the computer over, loosen the captive screw from the memory module cover, and lift the cover.

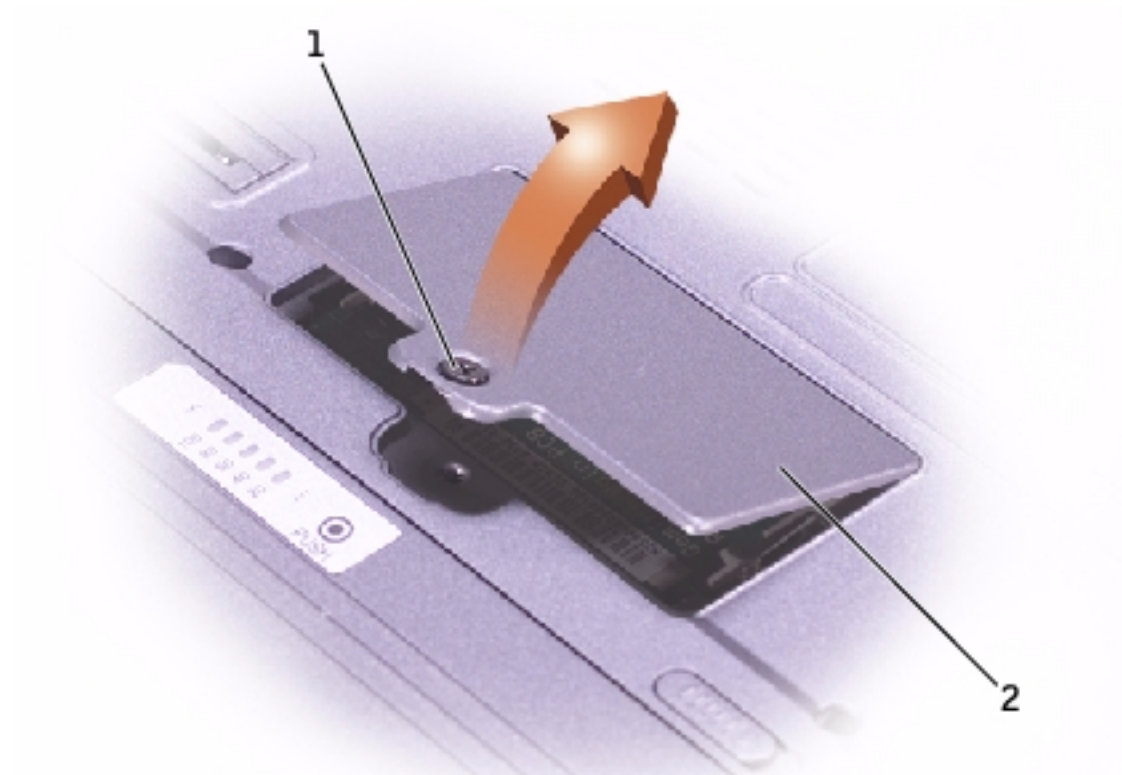

1	captive screw
2	memory module cover

## Removing the Memory Module

- ➔ **NOTICE:** To prevent damage to the memory module connector, do not use tools to spread the inner metal tabs that secure the memory module.
- ➔ **NOTICE:** Handle memory modules by their edges, and do not touch the components on a module.

1. Use your fingertips to spread apart the securing clips on each end of the memory module connector.

The module should pop up.

2. Remove the module from the connector.

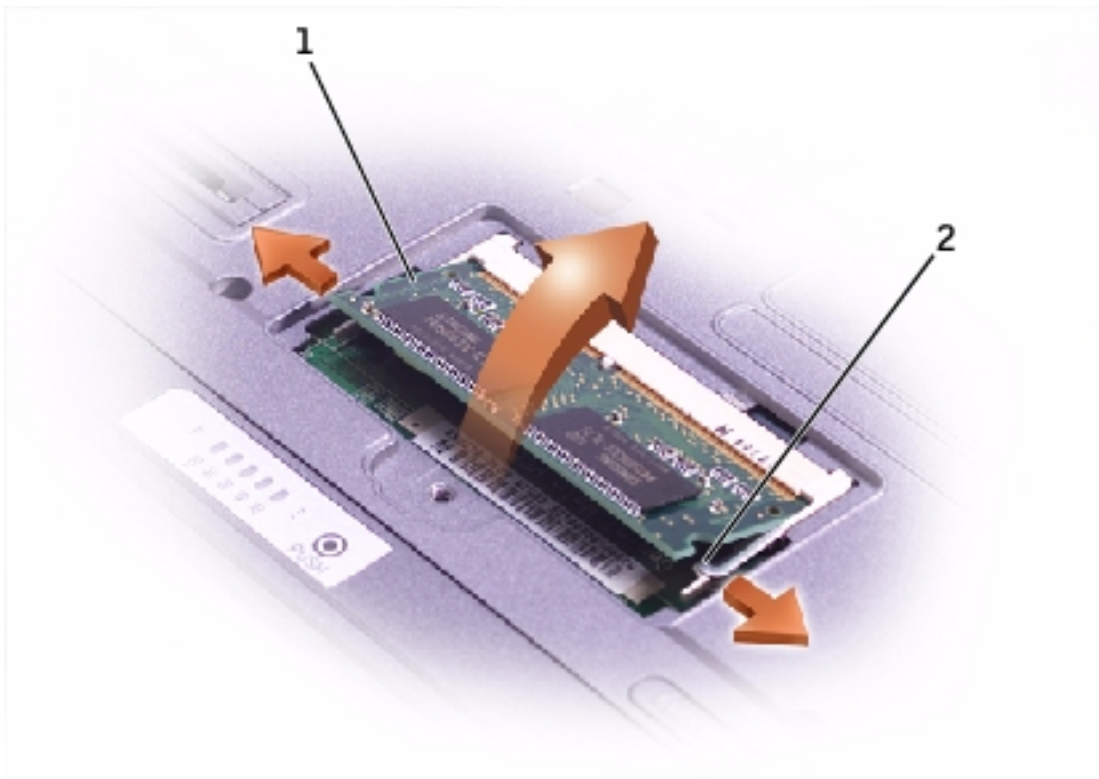

1	memory module
2	securing clips (2)

## Replacing the Memory Module

1. Ground yourself and install the new memory module:
  - a. Align the notch in the module with the slot in the center of the connector.
  - b. Slide the edge of the module firmly into the connector, and rotate the module down until you hear a click. If you do not hear the click, remove the module and reinstall it.



**NOTE:** If the memory module is not installed properly, the computer does not boot. No error message indicates this failure.



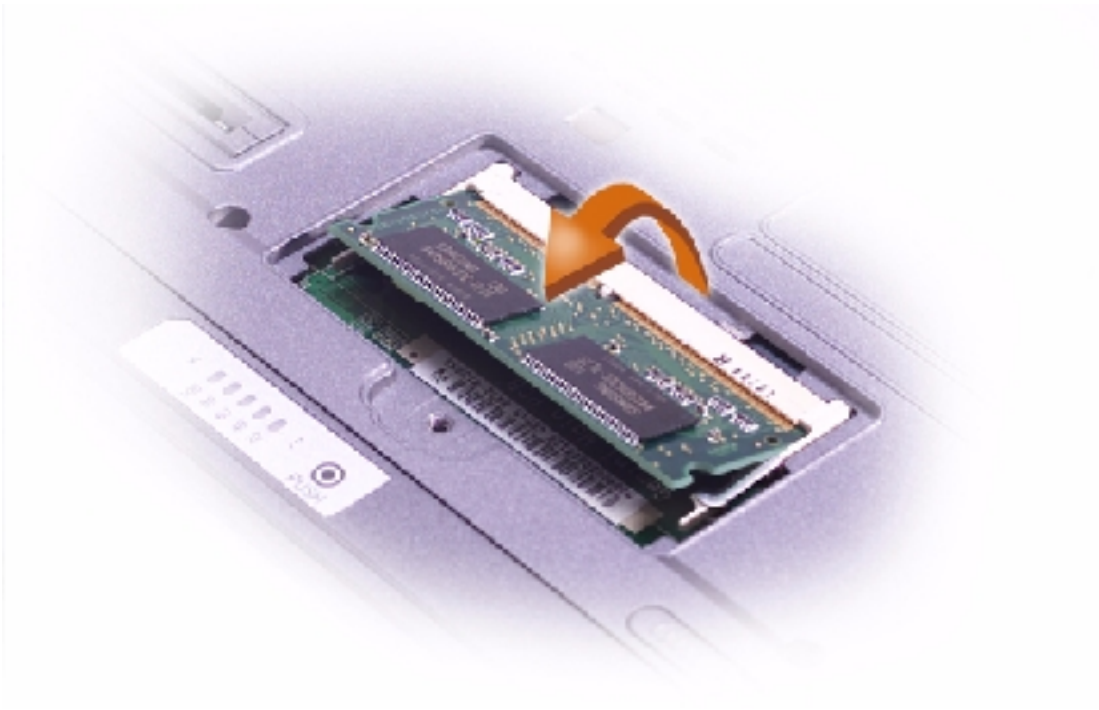

2. Replace the memory module cover and tighten the captive screw.

➔ **NOTICE:** If the memory module cover is difficult to close, remove the module and reinstall it. Forcing the cover to close may damage your computer.

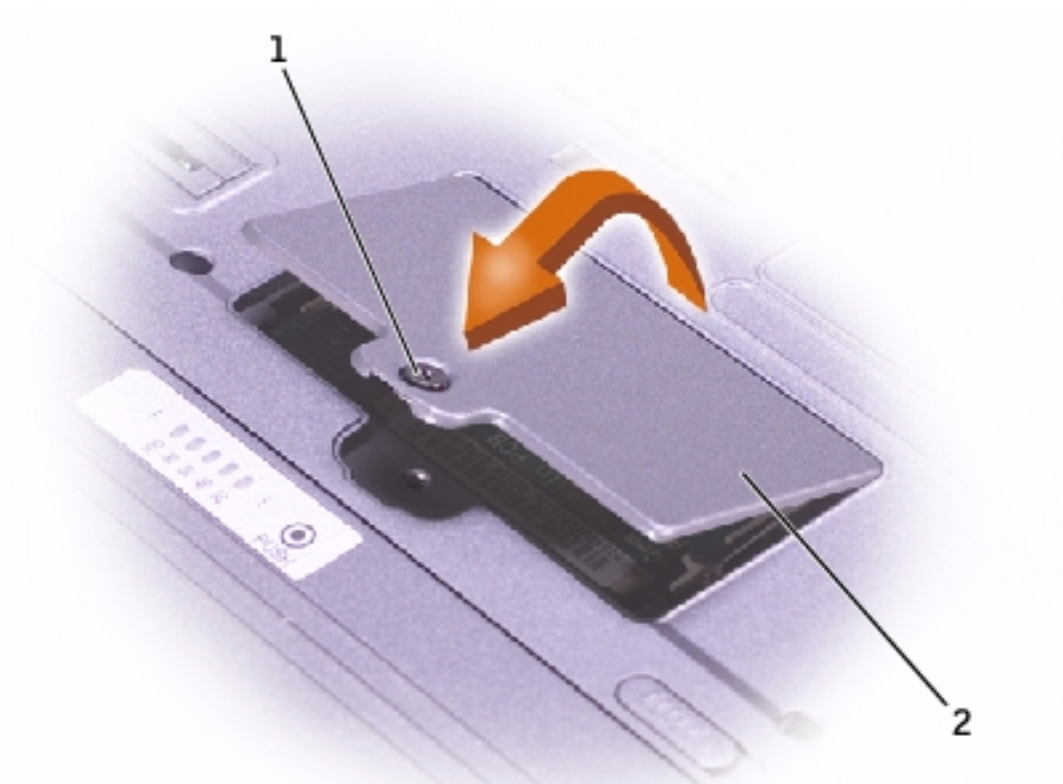

1	captive screw
2	memory module cover

3. Insert the battery into the battery bay, or connect the AC adapter to your computer and an electrical outlet.
4. Turn on the computer.

As the computer boots, it detects the additional memory and automatically updates the system configuration information.

---

## Mini PCI Card

### Removing the Mini PCI Card Cover

- ➡ **NOTICE:** Disconnect the computer and any attached devices from electrical outlets, and remove any installed batteries.
  - ➡ **NOTICE:** To avoid ESD, ground yourself by using a wrist grounding strap or by touching an unpainted metal surface on the computer.
  - ➡ **NOTICE:** Read "[Preparing to Work Inside the Computer](#)" before performing the following procedure.
1. If the computer is docked, undock it.
  2. Turn the computer over, loosen the captive screw from the Mini PCI card cover, and lift the cover.

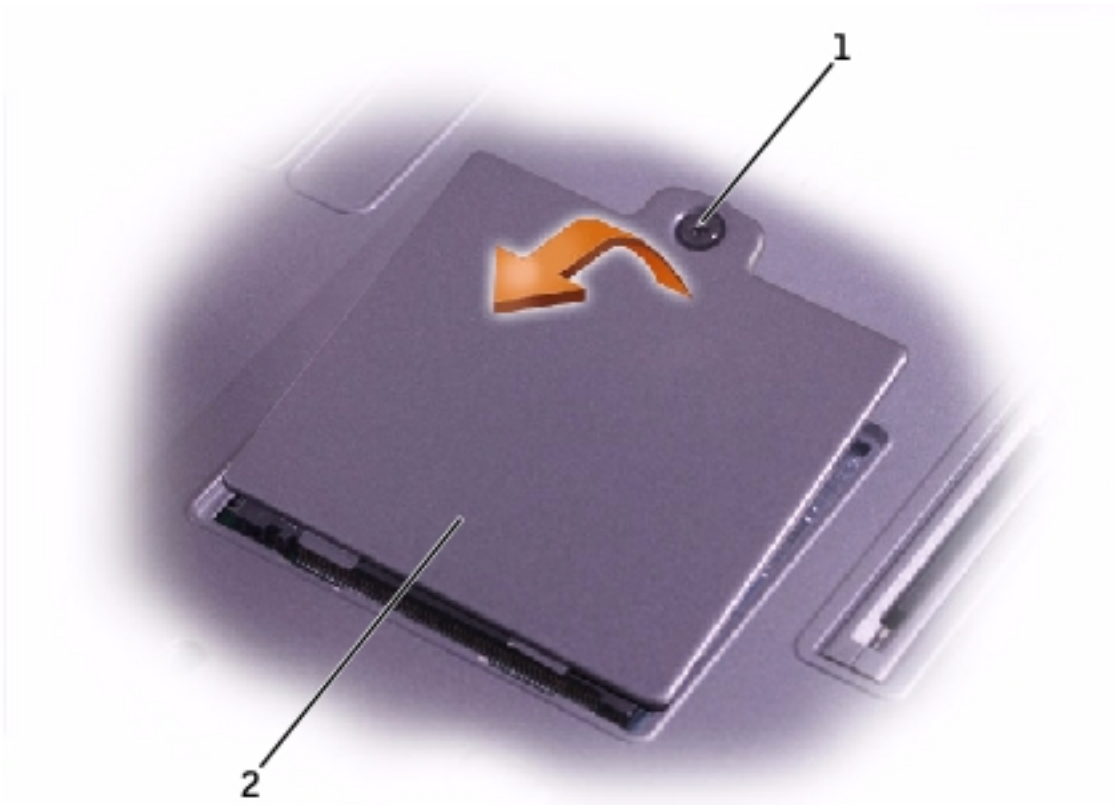

1	captive screw
2	Mini PCI card cover

## Removing the Mini PCI Card

1. Disconnect the antenna cable from the Mini PCI card.
2. Release the Mini PCI card by spreading the metal securing tabs until the card pops up slightly.
3. Lift the Mini PCI card out of its connector.



## Replacing the Mini PCI Card

1. Align the Mini PCI card with the connector at a 45-degree angle, and press the Mini PCI card into the connector.
2. Connect the antenna cable to the antenna connector on the Mini PCI card.

 **NOTICE:** The connectors are keyed for correct insertion; do not force the connections.

3. Lower the Mini PCI card toward the inner tabs to approximately a 20-degree angle.
4. Continue lowering the Mini PCI card until it snaps into the inner tabs of the connector.
5. Replace the cover and tighten the captive screw.

[Back to Contents Page](#)

[Back to Contents Page](#)

# Keyboard

## Dell™ Latitude™ X200 Service Manual

### Removing the Keyboard

- ➔ **NOTICE:** Disconnect the computer and any attached devices from electrical outlets.
  - ➔ **NOTICE:** To avoid ESD, ground yourself by using a wrist grounding strap or by touching an unpainted metal surface on the computer.
  - ➔ **NOTICE:** Read "[Preparing to Work Inside the Computer](#)" before performing the following procedure.
1. Remove the [battery](#).
  2. Remove the six M2 x 4-mm screws labeled with an arrow (one of the six screws is labeled "K" with an arrow) from the bottom of the computer.

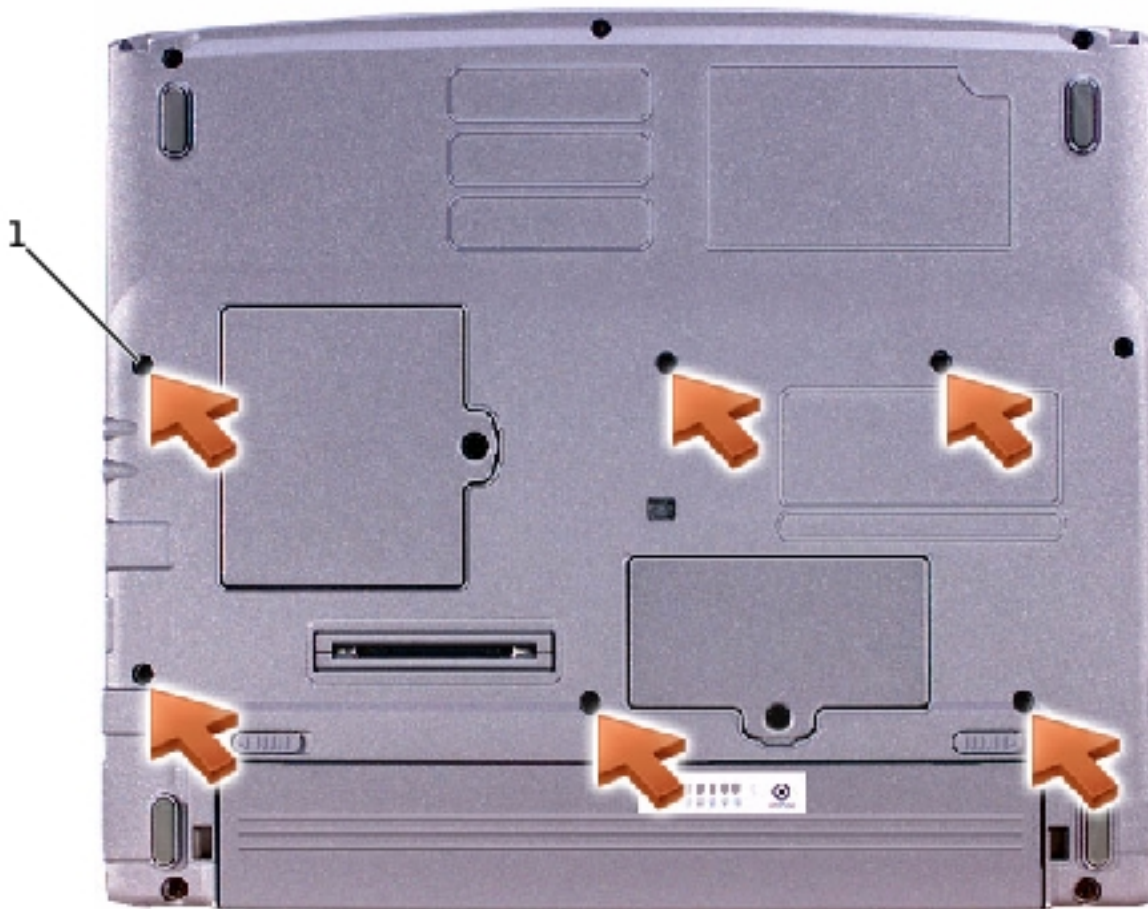

1	M2 x 4-mm screws (6)
---	----------------------

**NOTICE:** The keycaps on the keyboard are fragile, easily dislodged, and time-consuming to replace. Be careful when removing and handling the keyboard.

3. Turn the computer over, and insert a ¼-inch flat-blade screwdriver into the slot to the right of the keyboard locator tab.





1	keyboard locator tab
2	keyboard securing tabs (4)

4. Pry up the keyboard locator tab, and the keyboard pops up.



5. Pull the keyboard a small distance toward the front of the computer to release the four securing tabs located across the back edge of the keyboard.
6. Rotate the keyboard toward the front of the computer and place it face-down on the palm rest.

➔ **NOTICE:** Do not pull on the keyboard flex cable.

7. Open the ZIF connector on the system board by pulling the ZIF connector tabs toward the back of the computer.

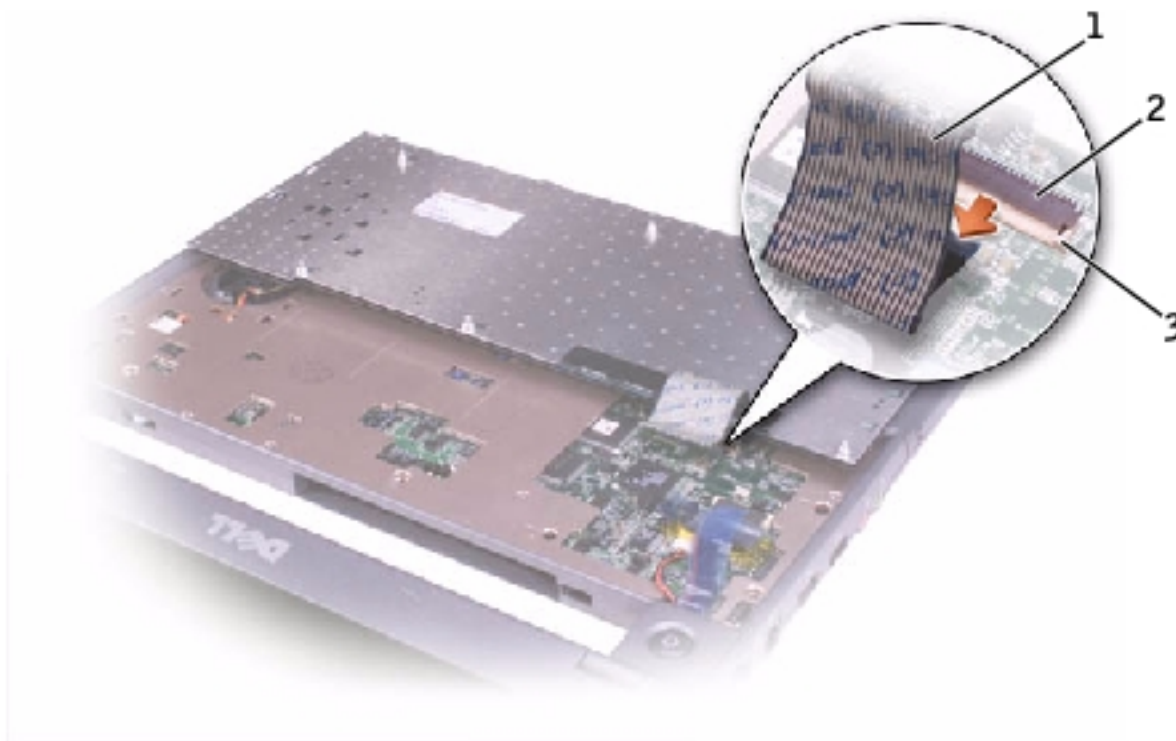

1	keyboard flex cable
2	ZIF connector
3	ZIF connector tabs (2)

8. Remove the keyboard flex cable from the ZIF connector.
9. Lift the keyboard up and out of the computer.

# Replacing the Keyboard

1. Place the keyboard face-down on the palm rest, with the keyboard flex cable pointing toward the back of the computer.

 **NOTICE:** To avoid damage to the connector pins, insert the keyboard flex cable evenly into the ZIF connector on the system board, and do not reverse the keyboard flex cable.

2. Ensure that the ZIF connector is open by pulling the ZIF connector tabs toward the back of the computer.
3. Press the keyboard flex cable into the ZIF connector.
4. Close the ZIF connector by pushing the ZIF connector tabs toward the front of the computer.

To aid with proper flex cable connection, a blue locator line has been added near the end of the flex cable. Press the cable into the connector until the blue line disappears and hold the cable steady while you close the ZIF connector. (The blue line may reappear after the connector is closed, which should not indicate a problem with the connection.)

 **NOTICE:** Position the keyboard flex cable so that it is not pinched when you replace the keyboard in the bottom case.

5. Rotate the keyboard back and fit it into the bottom case.
6. Ensure that all four keyboard securing tabs are engaged in their respective slots before trying to completely seat the keyboard. Press down on the left and right



keys to help control tab/slot alignment.

When the keyboard appears to be completely seated, confirm that the front edge of the keyboard is aligned with the edge of the palm rest before proceeding.

7. Replace the six M2 x 4-mm screws on the bottom of the computer.

[Back to Contents Page](#)

[Back to Contents Page](#)

# Palm Rest

## Dell™ Latitude™ X200 Service Manual

### Removing the Palm Rest

- ➔ **NOTICE:** Disconnect the computer and any attached devices from electrical outlets.
  - ➔ **NOTICE:** To avoid ESD, ground yourself by using a wrist grounding strap or by touching an unpainted metal surface on the computer.
  - ➔ **NOTICE:** Read "[Preparing to Work Inside the Computer](#)" before performing the following procedure.
1. Remove the [battery](#).
  2. Remove the [keyboard](#).
  3. Turn the computer over, and remove the four M2 x 4-mm screws from the bottom of the computer.

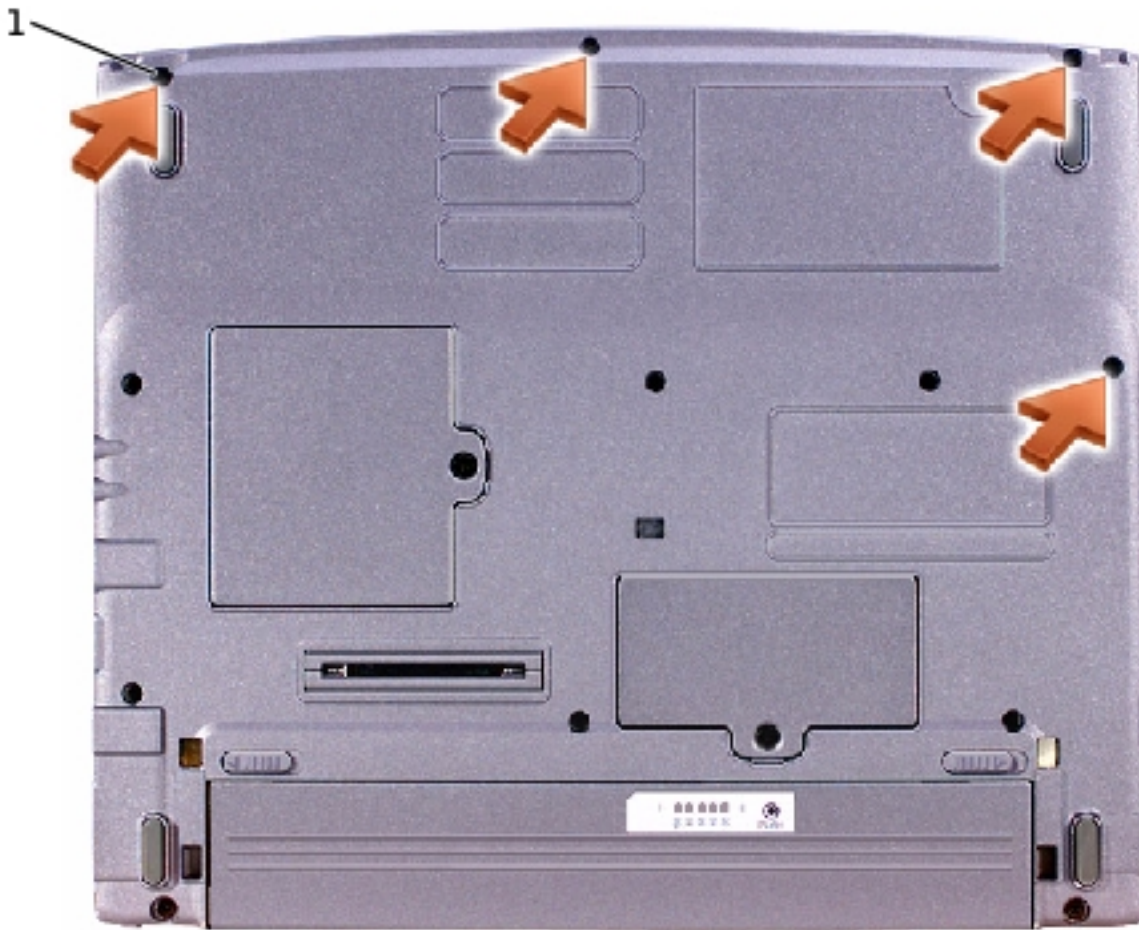

1	M2 x 4-mm screws (4)
---	----------------------

4. Turn the computer over, and open the display (if you have not already removed the display).
5. Lift the back edge of the palm rest, and rotate the palm rest forward.
6. Lift the ZIF connector, and disconnect the palm-rest flex cable from its ZIF connector on the system board.

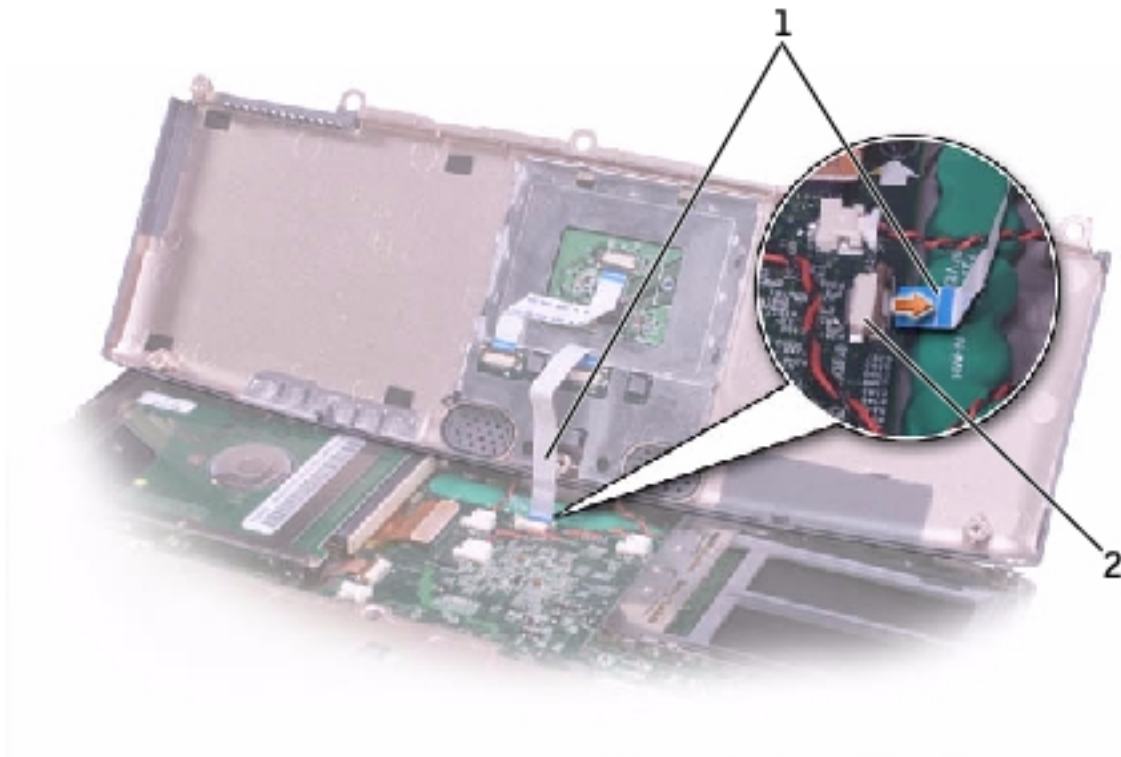

1	palm-rest flex cable
---	----------------------

2	ZIF connector
---	---------------

7. Lift the palm rest up and out of the computer.

## Replacing the Palm Rest

To aid with proper flex cable connection, a blue locator line has been added near the end of the palm-rest flex cable. When replacing the palm-rest flex cable, press the cable into the connector until the blue line aligns with the system board and hold it steady while you snap the ZIF connector down. (The blue line may reappear after the connector is closed, which should not indicate a problem with the connection.)

[Back to Contents Page](#)





[Back to Contents Page](#)

# Hard Drive

## Dell™ Latitude™ X200 Service Manual

### Removing the Hard Drive

-  **NOTICE:** Disconnect the computer and any attached devices from electrical outlets.
-  **NOTICE:** To avoid ESD, ground yourself by using a wrist grounding strap or by touching an unpainted metal surface on the computer.
-  **NOTICE:** Read "[Preparing to Work Inside the Computer](#)" before performing the following procedure.

1. Remove the [battery](#).
2. Remove the [keyboard](#).
3. Remove the [palm rest](#).
4. Loosen the three M2 x 5.5-mm screws that secure the hard drive to the bottom case.

Rubber grommets secure each screw to the hard drive so that you do not need to completely remove the screws.

-  **NOTE:** Each hard drive screw has an arrow beside it.



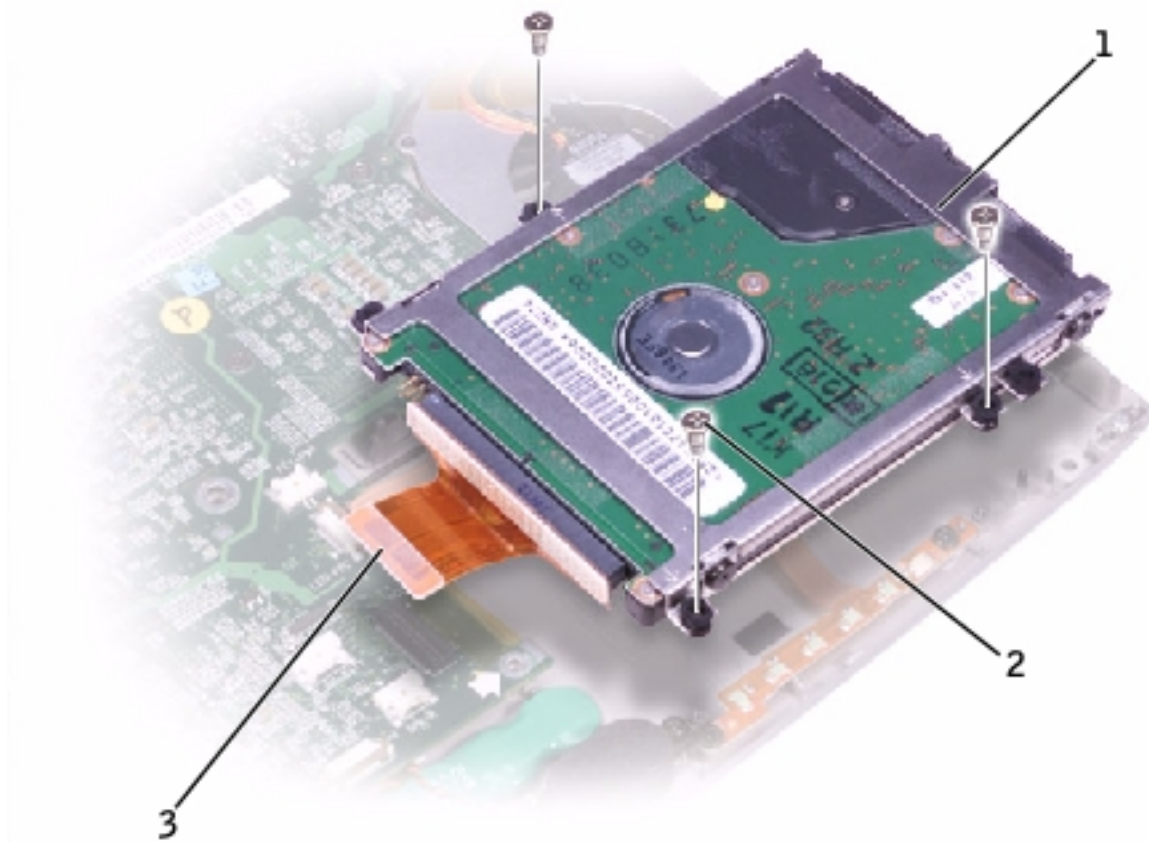

1	hard drive
2	M2 x 5.5-mm screws (3)
3	hard drive connector

5. Disconnect the hard drive connector from the system board.
6. Lift the hard drive up and out of the bottom case.

---

[Back to Contents Page](#)

[Back to Contents Page](#)

# Hinge Covers and Display Assembly

## Dell™ Latitude™ X200 Service Manual

• [Hinge Covers](#)

• [Display Assembly](#)

---

## Hinge Covers

### Removing the Hinge Covers

1. Remove the [battery](#).
2. On the inside of the battery bay, use your fingers to unhook the hinge covers from the back of the computer.



1	hinge covers (2)
---	------------------

3. Open the display 180 degrees.
4. Push up on the hinge covers to remove them from the computer.

## Replacing the Hinge Covers

1. Open the computer all the way (180 degrees) so that it lies flat against your work surface.
2. Place the hinge covers over the display hinges:
  - a. The left hinge cover fits over the power button and the right hinge cover fits over the Dell™ AccessDirect™ button. Both hinge covers pass through the display hinges to the back of the computer.
  - b. Ensure that the two securing tabs on the outer edge of each hinge cover are engaged in their respective slots.
3. Press down on the top of each hinge cover to snap the hinge covers into place.
4. Close the display.
5. Press the back of each hinge cover into the back of the computer.



**NOTE:** The back of each hinge cover has a tab that snaps into a slot on the back of the computer.

---

## Display Assembly

## Removing the Display Assembly



**NOTICE:** Disconnect the computer and any attached devices from electrical outlets.

- ➔ **NOTICE:** To avoid ESD, ground yourself by using a wrist grounding strap or by touching an unpainted metal surface on the computer.
- ➔ **NOTICE:** Read "[Preparing to Work Inside the Computer](#)" before performing the following procedure.

1. Remove the [battery](#).
2. Remove the [keyboard](#).
3. Remove the two M2 x 6-mm screws by the display hinges on the top of the computer.

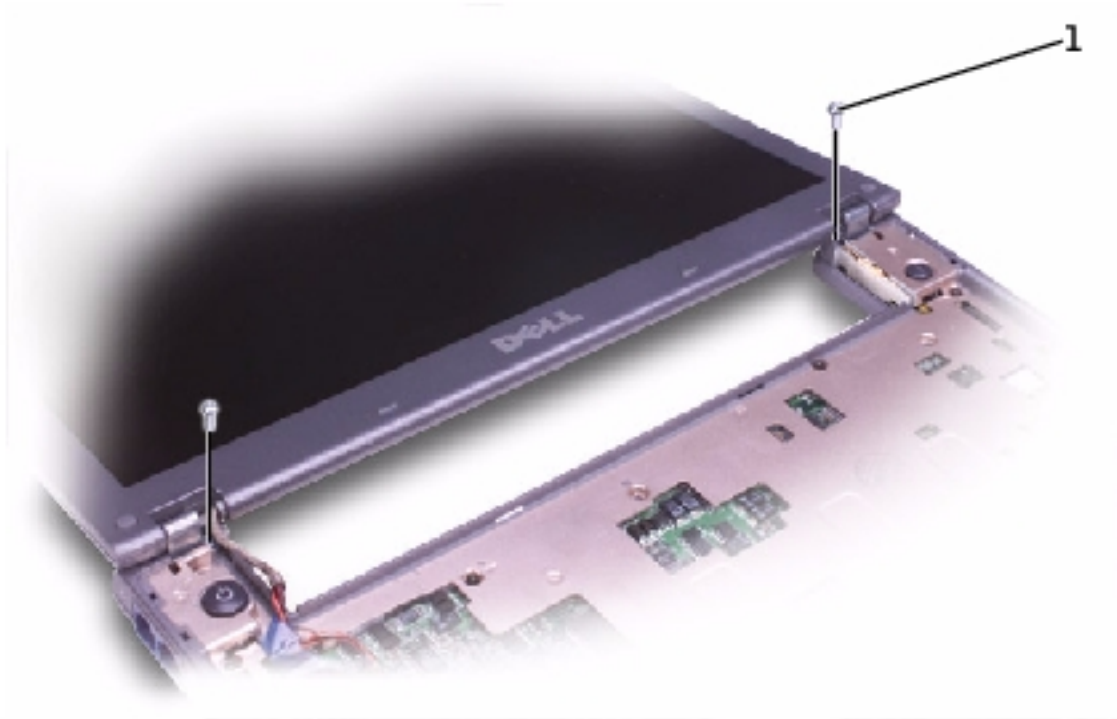

1	M2 x 6-mm screws (2)
---	----------------------

4. Turn the computer over, and remove the two M3 x 5-mm screws from the bottom of the computer.

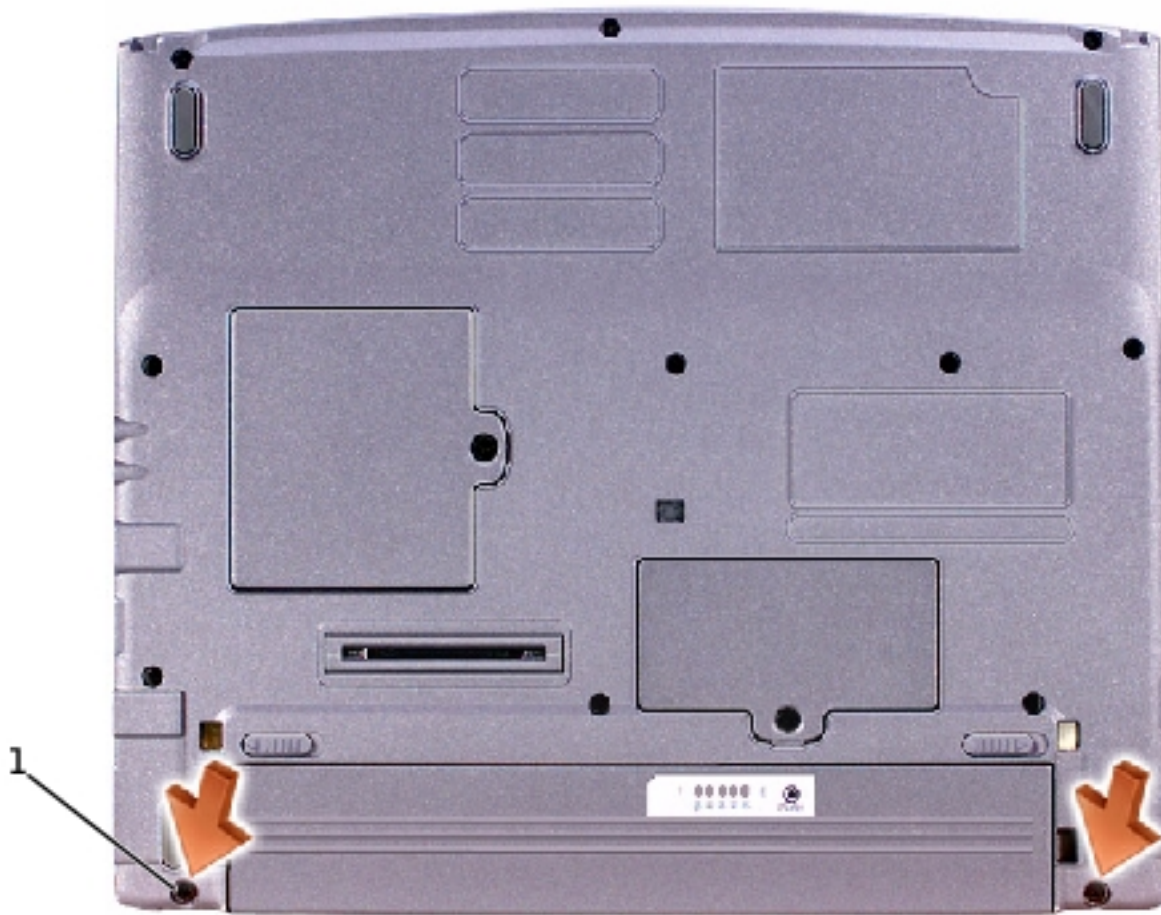

1	M3 x 5-mm screws (2)
---	----------------------

5. Turn the computer over, and open the display 180 degrees.
6. Disconnect the antenna connector.



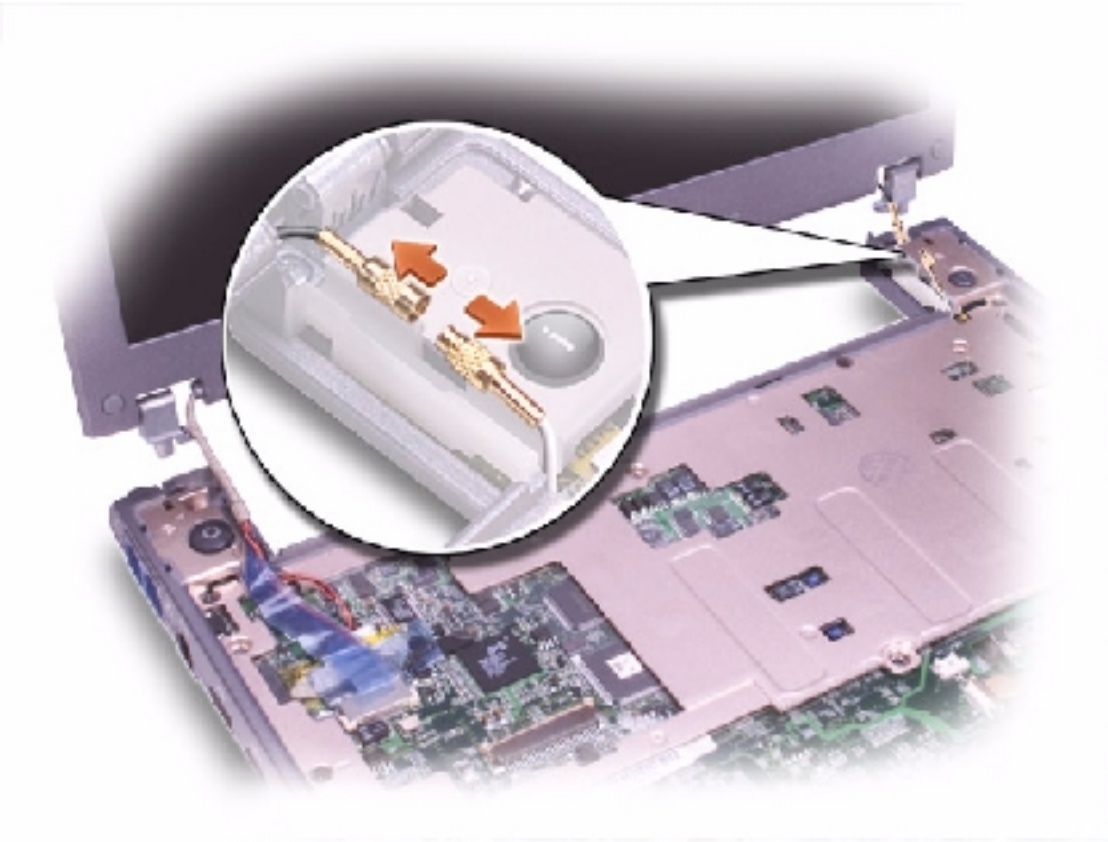

➔ **NOTICE:** Do not pull on the signal cable and inverter cable. Pull from the signal connector and inverter connector to disconnect the cables.

7. Disconnect the signal cable from the system board.
8. Remove the tape that secures the inverter connector, and then disconnect the inverter cable from the system board.

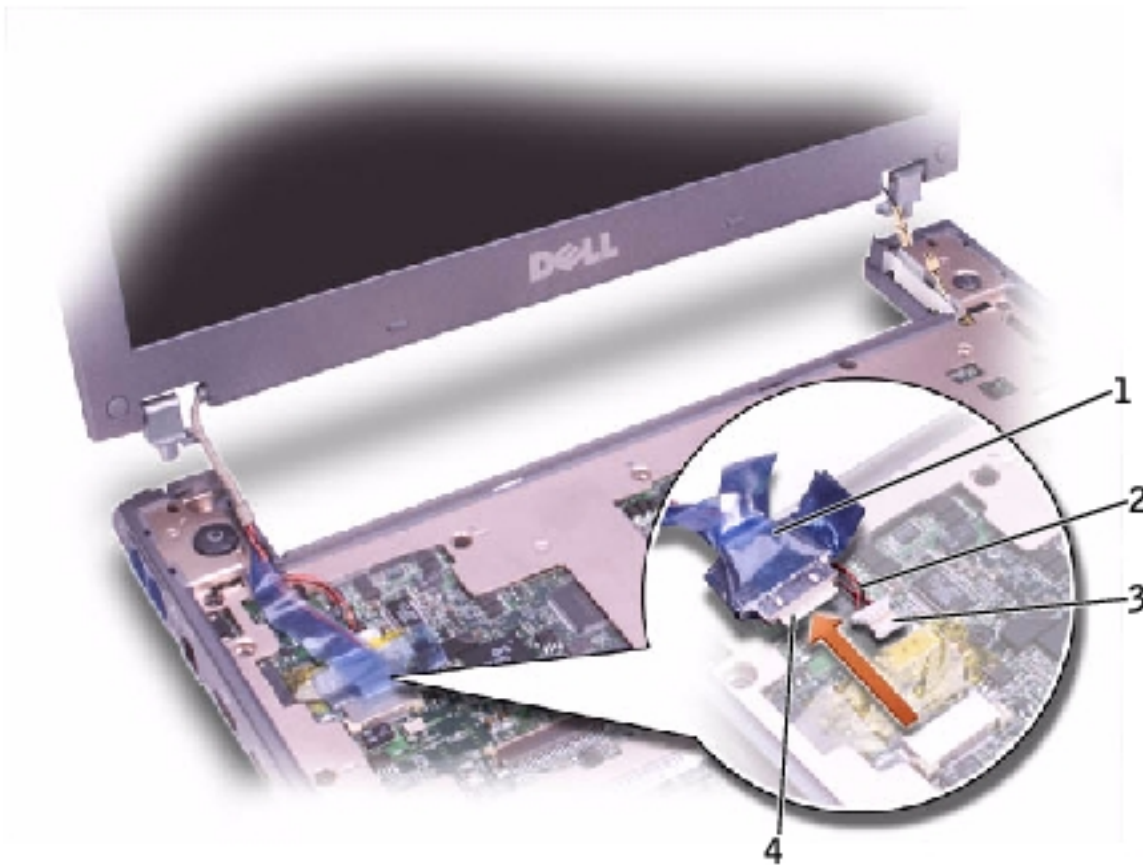

1	signal cable
2	inverter cable
3	inverter connector
4	signal connector

9. Move the display assembly to an upright position and pull it up out of the bottom case.

[Back to Contents Page](#)







[Back to Contents Page](#)

# Keyboard Tray

## Dell™ Latitude™ X200 Service Manual

### Removing the Keyboard Tray

-  **NOTICE:** Disconnect the computer and any attached devices from electrical outlets.
-  **NOTICE:** To avoid ESD, ground yourself by using a wrist grounding strap or by touching an unpainted metal surface on the computer.
-  **NOTICE:** Read "[Preparing to Work Inside the Computer](#)" before performing the following procedure.

1. Remove the [battery](#).
2. Remove the [keyboard](#).
3. Remove the [palm rest](#).
4. Remove the [hinge covers](#).
5. Remove the [display assembly](#).
6. Remove the seven M2 x 4-mm screws that secure the keyboard tray to the system board.

 **NOTE:** Each keyboard tray screw has an arrow beside it.

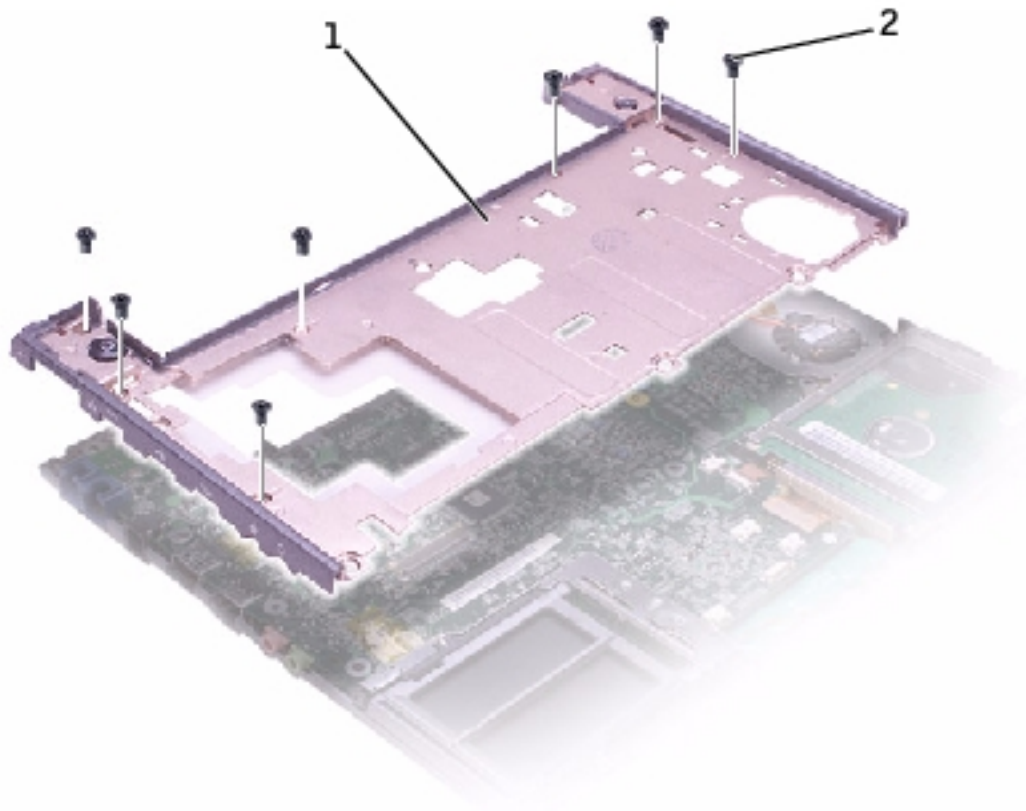

1	keyboard tray
2	M2 x 4-mm screws (7)

7. Lift the keyboard tray up and out of the bottom case.



**NOTE:** The air vent on the right side of the computer comes loose when the keyboard tray is removed.

## Replacing the Keyboard Tray

1. Replace the air vent:

- a. Align the two pin holes on the bottom of the air vent with the pins on the bottom case by the cooling fan.
- b. Slide the air vent into the bottom case.

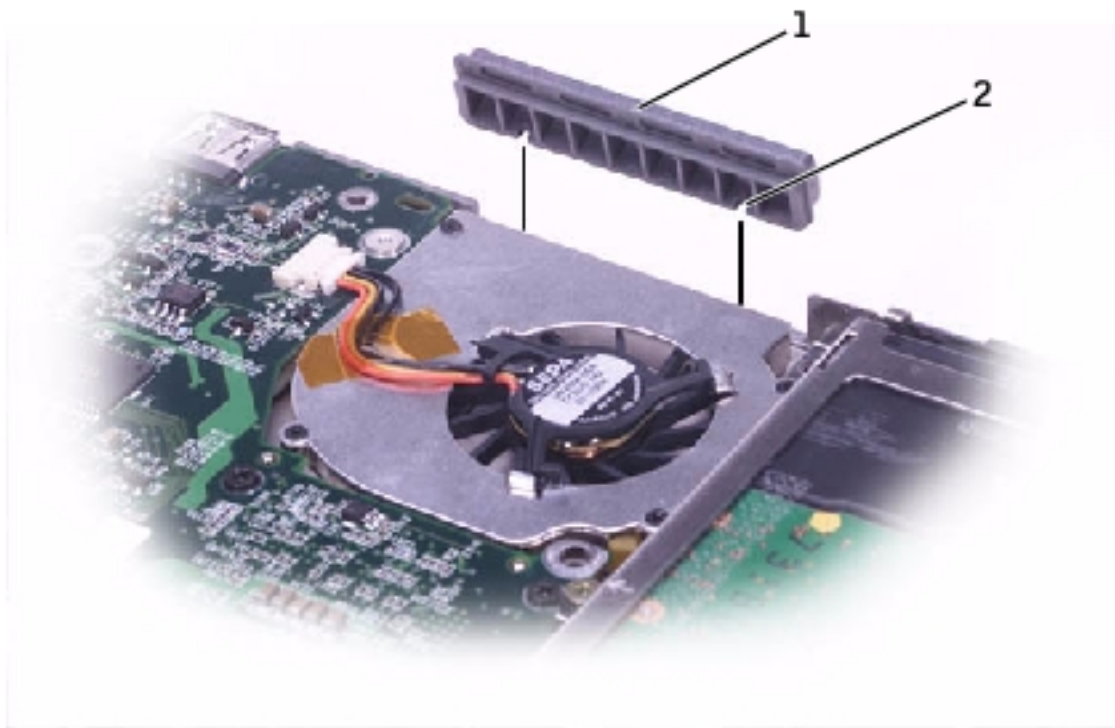

1	air vent
2	pin holes (2)

2. Replace the keyboard tray.
3. Reinstall the seven M2 x 4-mm screws that secure the keyboard tray to the system board.

---

[Back to Contents Page](#)

[Back to Contents Page](#)

# Reserve Battery

## Dell™ Latitude™ X200 Service Manual

### Removing the Reserve Battery

- ➔ **NOTICE:** Disconnect the computer and any attached devices from electrical outlets.
- ➔ **NOTICE:** To avoid ESD, ground yourself by using a wrist grounding strap or by touching an unpainted metal surface on the computer.
- ➔ **NOTICE:** Read "[Preparing to Work Inside the Computer](#)" before performing the following procedure.
  1. Remove the [battery](#).
  2. Remove the [keyboard](#).
  3. Remove the [palm rest](#).
- ➔ **NOTICE:** Do not pull on the reserve battery cable. Pull from the reserve battery connector to disconnect the cable.
  4. Disconnect the reserve battery cable from the system board connector.

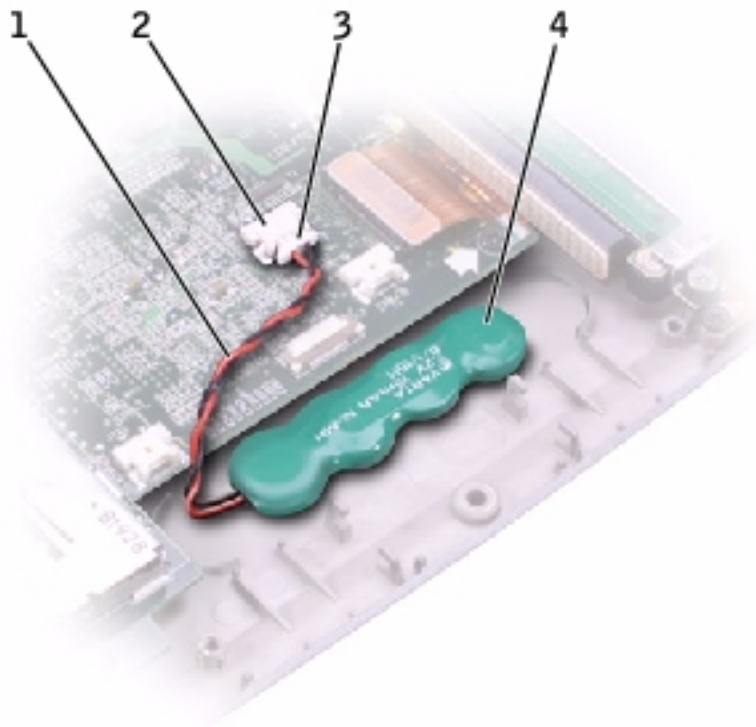

1	reserve battery cable
2	system board connector
3	reserve battery connector
4	reserve battery

5. Pry the reserve battery free from the bottom case. The reserve battery is attached to the bottom case with a piece of adhesive tape.
6. Remove any remnants of the adhesive tape from the bottom case.

## Replacing the Reserve Battery

1. Connect the reserve battery connector to the system board connector.
2. Press the reserve battery into place on the bottom case.
3. Update the BIOS using a flash BIOS update program. For instructions on how to flash the BIOS, see "[Flashing the BIOS](#)."



[Back to Contents Page](#)

[Back to Contents Page](#)

# Speakers

## Dell™ Latitude™ X200 Service Manual

### Removing the Speakers

-  **NOTICE:** Disconnect the computer and any attached devices from electrical outlets.
-  **NOTICE:** To avoid ESD, ground yourself by using a wrist grounding strap or by touching an unpainted metal surface on the computer.
-  **NOTICE:** Read "[Preparing to Work Inside the Computer](#)" before performing the following procedure.

1. Remove the [battery](#).
2. Remove the [keyboard](#).
3. Remove the [palm rest](#).
4. Remove the M2 x 4-mm screw that secures the speaker to the bottom case.

 **NOTE:** The left and right speakers are interchangeable.

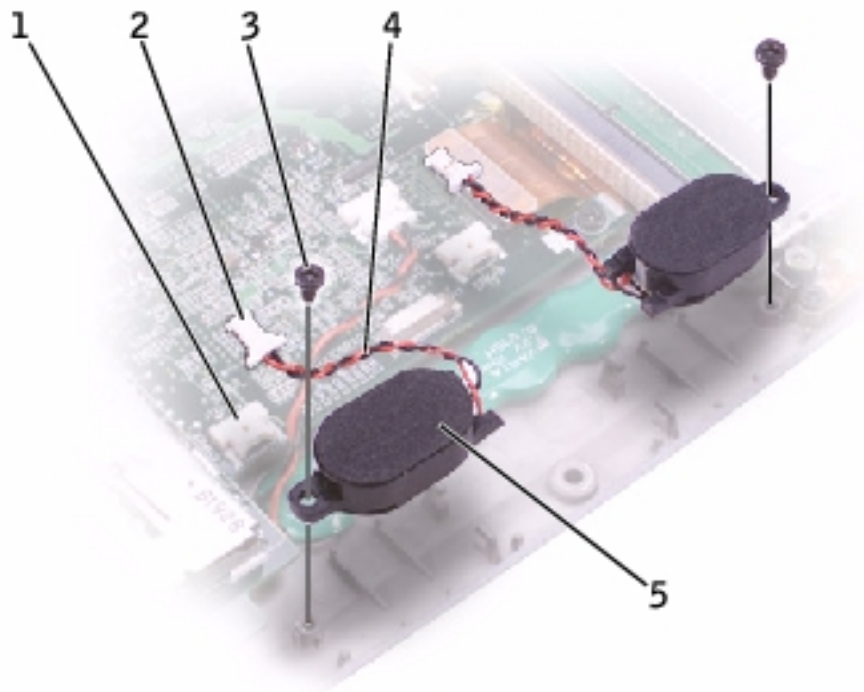

1	system board connector (1 per speaker)
2	speaker connector (1 per speaker)
3	M2 x 4-mm screw (1 per speaker)
4	speaker cable (1 per speaker)
5	speakers (2)

➡ **NOTICE:** Do not pull on the speaker cable. Pull from the speaker connector to disconnect the cable.

5. Disconnect the speaker cable from the system board connector.

➡ **NOTICE:** Handle the speakers with care to avoid damaging them.

6. Remove the speaker by pulling it straight up and out of the bottom case.



[Back to Contents Page](#)

[Back to Contents Page](#)

# Cooling Fan

## Dell™ Latitude™ X200 Service Manual

### Removing the Cooling Fan

- ➔ **NOTICE:** Disconnect the computer and any attached devices from electrical outlets.
- ➔ **NOTICE:** To avoid ESD, ground yourself by using a wrist grounding strap or by touching an unpainted metal surface on the computer.
- ➔ **NOTICE:** Read "[Preparing to Work Inside the Computer](#)" before performing the following procedure.

1. Remove the [battery](#).
2. Remove the [keyboard](#).
3. Remove the [palm rest](#).
4. Remove the [hinge covers](#).
5. Remove the [display assembly](#).
6. Remove the [keyboard tray](#).
7. Remove the four M2 x 3-mm screws that secure the cooling fan to the system board.

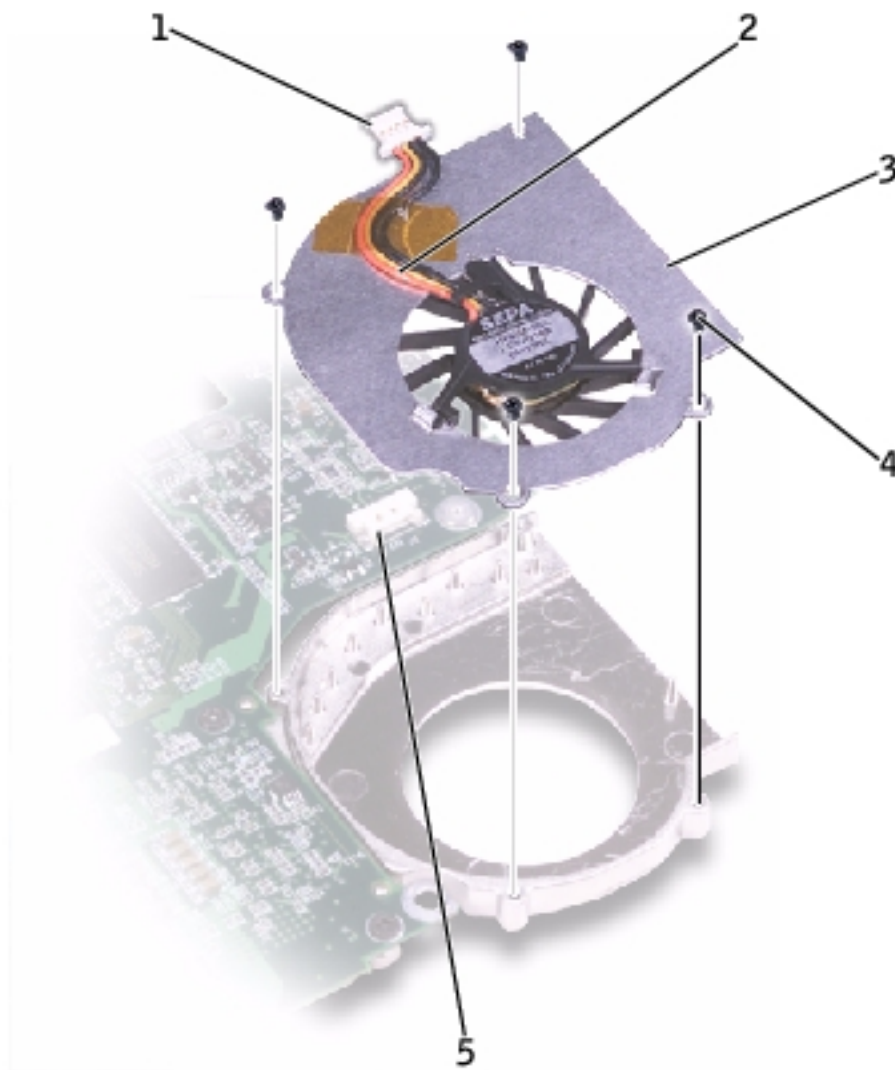

1	cooling fan connector
2	cooling fan cable
3	cooling fan
4	M2 x 3-mm screws (4)
5	system board connector

8. Remove the tape that secures the cooling fan cable to the fan.

➔ **NOTICE:** Do not pull on the cooling fan cable. Pull from the cooling fan connector to disconnect the cable.

9. Disconnect the cooling fan cable from the system board connector.

**10. Lift the cooling fan up and out of the bottom case.**

---



[Back to Contents Page](#)

[Back to Contents Page](#)

# System Board

## Dell™ Latitude™ X200 Service Manual

### Removing the System Board

-  **NOTICE:** Disconnect the computer and any attached devices from electrical outlets.
-  **NOTICE:** To avoid ESD, ground yourself by using a wrist grounding strap or by touching an unpainted metal surface on the computer.
-  **NOTICE:** Read "[Preparing to Work Inside the Computer](#)" before performing the following procedure.

1. Remove the [battery](#).
2. Remove the [keyboard](#).
3. Remove the [palm rest](#).
4. Remove the [hinge covers](#).
5. Remove the [display assembly](#).
6. Remove the [keyboard tray](#).
7. Remove the [hard drive](#).
8. Remove the [memory module](#).
9. Remove the [Mini PCI card](#), if present.
10. Remove the four M2 x 4-mm screws that secure the system board to the bottom case.

 **NOTE:** Each system board screw has an arrow beside it.

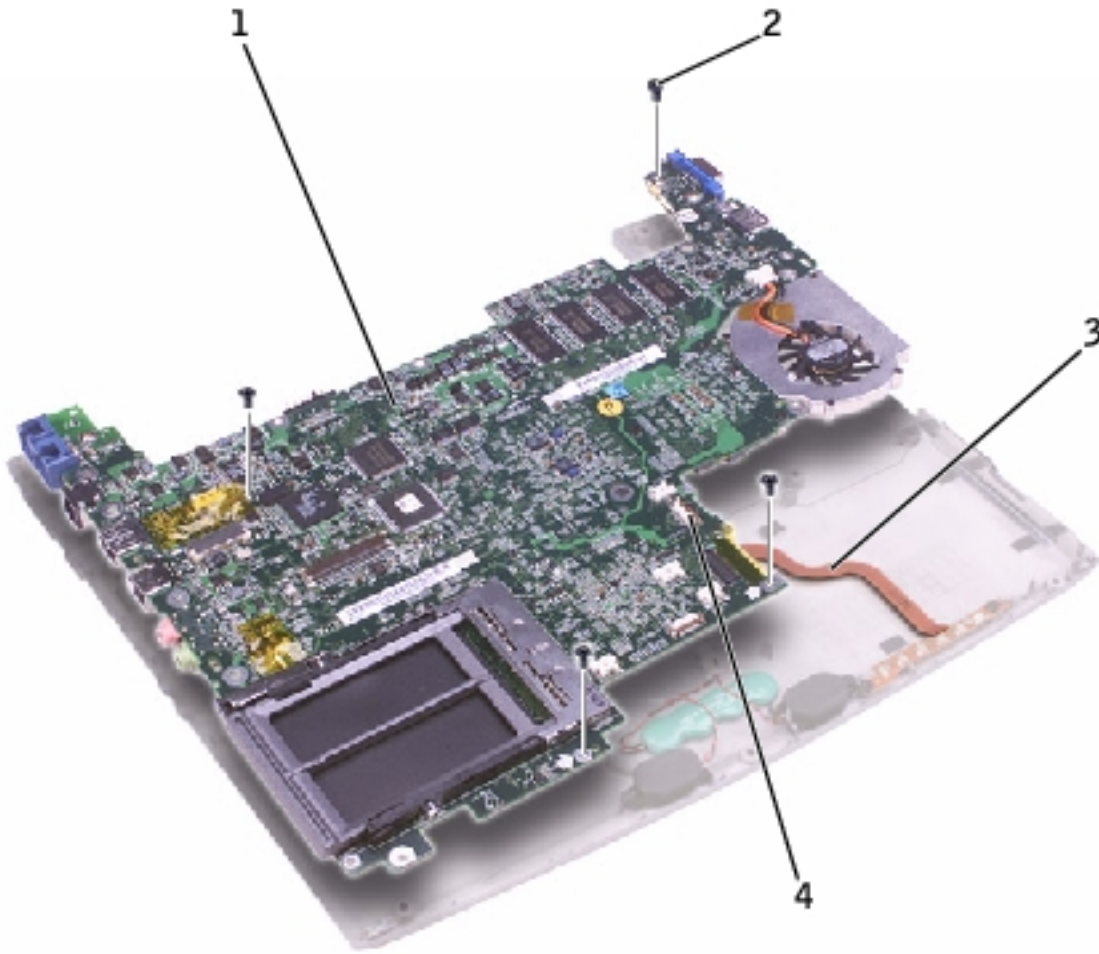

1	system board
2	M2 x 4-mm screws (4)
3	status light (LED) cable
4	ZIF connector

11. Disconnect the [left and right speakers](#) from their system board connectors.
12. Disconnect the [reserve battery](#) connector from the system board connector.
13. Lift the ZIF connector, and remove the status light (LED) cable from its ZIF connector on the system board.
14. Lift the system board up and out of the bottom case.

15. [Remove the modem daughter card](#), and set it aside to install in the replacement system board.

## Replacing the System Board

1. [Install the modem daughter card](#) that you removed from the old system board in the replacement system board.
2. Place the system board in the bottom case.



**NOTE:** Route cables so that they will not be crimped or pinched when the complete assembly is put back together.

3. Reconnect the status light (LED) cable to the system board ZIF connector.
4. Reinstall the four M2 x 4-mm screws that secure the system board to the bottom case.



**NOTE:** After replacing the system board, enter the computer service tag sequence into the BIOS of the replacement system board.

---

[Back to Contents Page](#)

[Back to Contents Page](#)

# Modem Daughter Card

## Dell™ Latitude™ X200 Service Manual

### Removing the Modem Daughter Card

- ➔ **NOTICE:** Disconnect the computer and any attached devices from electrical outlets.
- ➔ **NOTICE:** To avoid ESD, ground yourself by using a wrist grounding strap or by touching an unpainted metal surface on the computer.
- ➔ **NOTICE:** Read "[Preparing to Work Inside the Computer](#)" before performing the following procedure.

1. Remove the [battery](#).
2. Remove the [keyboard](#).
3. Remove the [palm rest](#).
4. Remove the [hinge covers](#).
5. Remove the [display assembly](#).
6. Remove the [keyboard tray](#).
7. Remove the [hard drive](#).
8. Remove the [system board](#).
9. Turn the system board over, and remove the M2 x 4-mm screw that secures the modem daughter card to the system board.
10. Use the pull tab to pull the modem daughter card straight up out of its connector.



**NOTICE:** Do not pull on the modem cable. Pull from the modem connector to disconnect the cable.

11. Disconnect the modem cable from the modem daughter card.

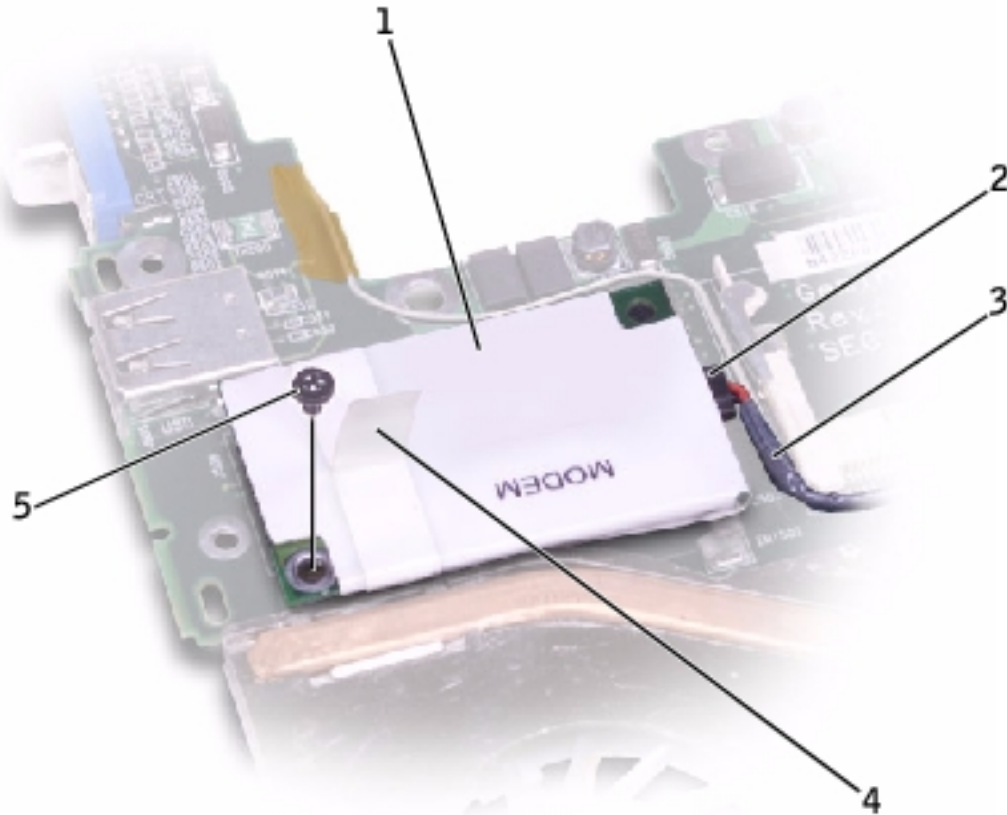

1	modem daughter card
2	modem connector
3	modem cable
4	pull tab
5	M2 x 4-mm screw

## Replacing the Modem Daughter Card

1. Connect the modem cable to the modem.



**NOTICE:** The connectors are keyed for correct insertion; do not force the connections.

2. Align the modem with the screw hole and press the modem into the connector on the system board.
  3. Use the screw hole to align the card, and press the card into its connector on the system board.
  4. Install the M2 x 4-mm screw that secures the modem to the system board.
- 

[Back to Contents Page](#)

[Back to Contents Page](#)

# Battery Latches

## Dell™ Latitude™ X200 Service Manual

### Removing the Battery Latches

- ➔ **NOTICE:** Disconnect the computer and any attached devices from electrical outlets.
- ➔ **NOTICE:** To avoid ESD, ground yourself by using a wrist grounding strap or by touching an unpainted metal surface on the computer.
- ➔ **NOTICE:** Read "[Preparing to Work Inside the Computer](#)" before performing the following procedure.

1. Remove the [battery](#).
2. Remove the [keyboard](#).
3. Remove the [palm rest](#).
4. Remove the [hinge covers](#).
5. Remove the [display assembly](#).
6. Remove the [keyboard tray](#).
7. Remove the [hard drive](#).
8. Remove the [memory module](#).
9. Remove the [Mini PCI card](#), if present.
10. Remove the [system board](#).
11. On the inside of the bottom case, use your fingers to unhook the latch from the bottom case and the snap tabs, catching the latch button on the outside of the bottom case.

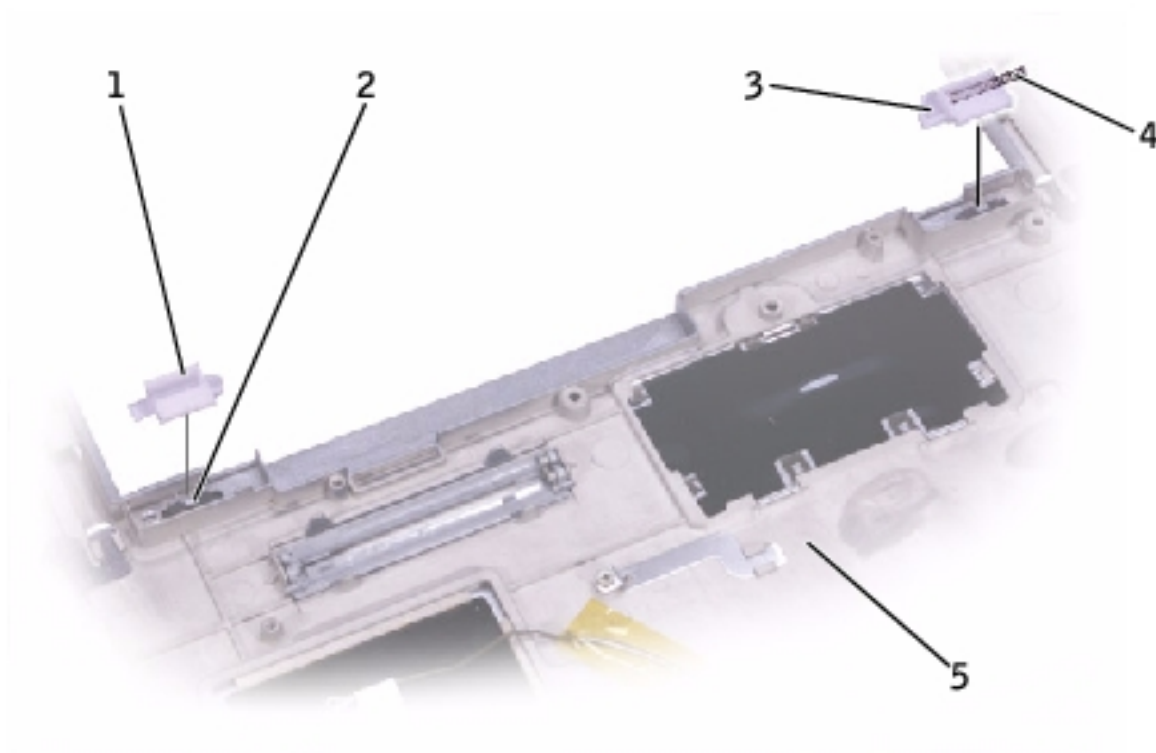

1	battery lock latch
2	snap tabs (3 per latch button)
3	battery latch release
4	spring
5	bottom case

## Replacing the Battery Latches

1. Snap in the new latch button from behind the bottom case, making certain that the snap tabs are fully engaged in the latch.



**NOTE:** The battery latch release has a spring and should be installed on the right side of the bottom case.

2. Ensure that the newly installed latch moves smoothly and freely when pushed and released.

[Back to Contents Page](#)

[Back to Contents Page](#)

# Flashing the BIOS

## Dell™ Latitude™ X200 Service Manual

To update the basic input/output system (BIOS):

1. Go to **support.dell.com**. If this is your first time to use the website, complete the one-time registration.
2. Enter the service tag sequence for your computer or select the appropriate Dell™ computer.

Click **Go**.

3. Click **Downloads**.
4. Select the appropriate operating system and language for your computer.
5. Select the **FlashBIOS Updates** download category.

Click **Go**.

6. Click the BIOS link and follow the instructions to download the BIOS to your computer.

---

[Back to Contents Page](#)

[Back to Contents Page](#)

# Pin Assignments for I/O Connectors

## Dell™ Latitude™ X200 Service Manual

- [Pin Assignments for the Computer](#)
  - [Pin Assignments for the Media Base](#)
- 

## Pin Assignments for the Computer

### USB Connector

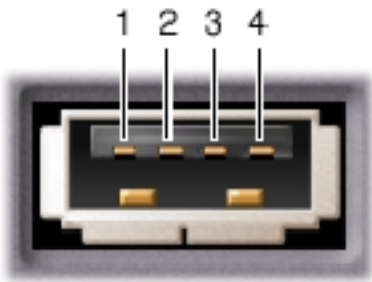

Pin	Signal
1	VCC
2	-Data
3	+Data
4	Ground

### Video Connector



Pin	Signal	Pin	Signal
1	RED	9	CRT_VCC
2	GREEN	10	GND
3	BLUE	11	NC
4	NC	12	DAT_DDC2
5	GND	13	HSYNC
6	GND	14	VSYNC
7	GND	15	CLK_DDC2
8	GND		

## IEEE 1394 Connector



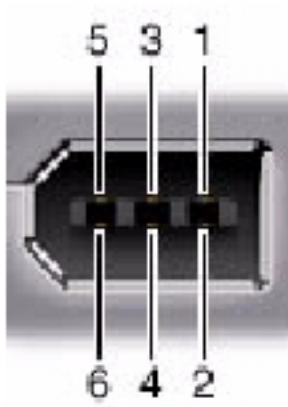

1	TPA-
2	TPB-
3	P12V
4	GND
5	TPB+
6	TPA+

---

## **Pin Assignments for the Media Base Docking Connector**

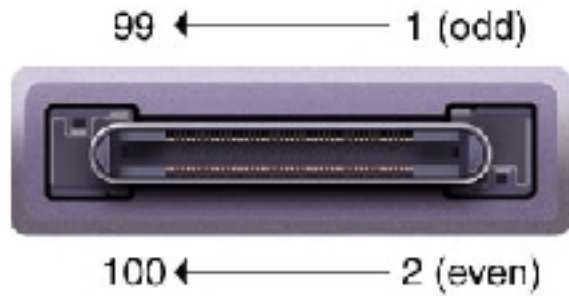

Pin	Signal	Pin	Signal
1	DCK3_DOCK_IN2	51	P3.3V_LAN
2	KBC3_DCKRST	52	FDD3_STEP
3	ADID	53	PS25_KCLK
4	DCK_DCIN	54	FDD3_WGATE
5	PIO3_STROBE	55	PS25_KDATA
6	VGA3_RED	56	FDD3_WP
7	PIO3_ACK	57	PS25_MCLK
8	VGA3_GREEN	58	FDD3_HDSEL
9	PIO3_BUSY	59	PS25_MDATA
10	VGA3_BLUE	60	NC
11	PIO3_PE	61	SIO3_DTR1
12	VGA5_DDCD	62	1394_TPB-
13	NC	63	SIO3_TXD1
14	VGA5_DDCC	64	1394_TPB+
15	PIO3_SLCT	65	SIO3_RTS1
16	VGA5_HSYNC	66	NC
17	PIO3_AUTOFD	67	NC

18	VGA5_VSYNC	68	1394_TPA-
19	PIO3_ERROR	69	SIO3_CTS1
20	NC	70	1394_TPA+
21	PIO3_INIT	71	SIO3_RI1
22	KBC3_EJECT	72	NC
23	PIO3_SLCTIN	73	SIO3_RXD1
24	CHP3_DCKSTS	74	DCK5_SPKR_MUTE
25	NC	75	SIO3_DSR1
26	USB3_P2+	76	CD5_L
27	PIO3_PD(0)	77	SIO3_DCD1
28	USB3_P2-	78	CD5_R
29	PIO3_PD(1)	79	NC
30	NC	80	CD5_COM
31	PIO3_PD(2)	81	KBC3_DCKDCEN
32	FDD3_INDEX	82	DCK5_LINE_OUT_L
33	PIO3_PD(3)	83	AUD3_SPDIF
34	FDD3_DSKCHG	84	DCK5_LINE_OUT_R
35	PIO3_PD(4)	85	NC
36	FDD3_DIR	86	NC
37	PIO3_PD(5)	87	USB3_P5+
38	FDD3_WDATA	88	LAN3_RX+
39	PIO3_PD(6)	89	USB3_P5-
40	FDD3_TRK0	90	LAN3_RX-
41	PIO3_PD(7)	91	NC
42	FDD3_RDATA	92	NC
43	NC	93	USB3_P4+
44	NC	94	LAN3_TX+

45	LAN3_EECLK	95	USB3_P4-
46	FDD3_J3MODE	96	LAN3_TX-
47	LAN3_DTOEE	97	NC
48	FDD3_DS0	98	NC
49	LAN3_DFRMEE	99	KBC3_DCKPWRON
50	FDD3_MTR0	100	DCK3_DOCK_IN1

## PS/2 Connector

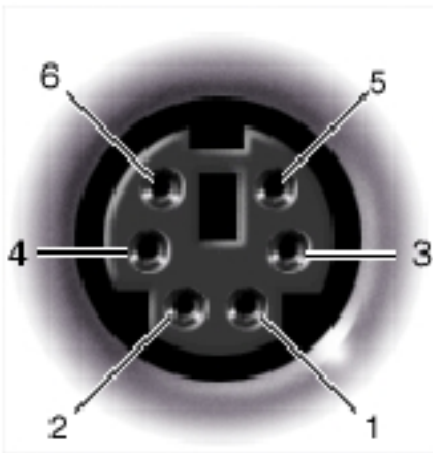

Pin	Signal
1	DAT_KBD
2	DAT_SM1
3	GND
4	PS2VCC
5	CLK_KBD
6	CLK_SM1

## USB Connector

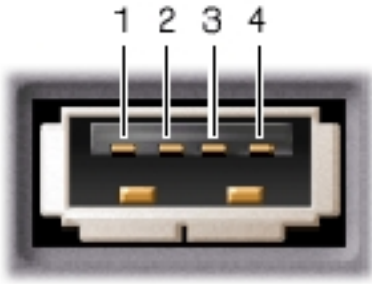

Pin	Signal
1	VCC
2	-Data
3	+Data
4	Ground

## IEEE 1394 Connector



1	TPB-
2	TPB+
3	TPA-
4	TPA-

## Serial Connector



1 2 3 4 5  
6 7 8 9

Pin	Signal	Pin	Signal
1	DCD	6	DSR
2	RXDA	7	RTS
3	TXDA	8	CTS
4	DTR	9	RI
5	GND		

## Parallel Connector



13 12 11 10 9 8 7 6 5 4 3 2 1  
25 24 23 22 21 20 19 18 17 16 15 14

Pin	Signal	Pin	Signal
1	STRB#/5V	10	ACK#/DRV#
2	PD0/INDEX#	11	BUSY/MTR#
3	PD1/TRK0#	12	PE/WDATA#
4	PD2/WP#	13	SLCT/WGATE#
5	PD3/RDATA#	14	AUTOFD#
6	PD4/DSKCHG#	15	ERROR#/HDSEL#
7	PD5F	16	INIT#/DIR#
8	PD6F	17	SLCT_IN/#STEP#
9	PD7F	18-25	GND

## Video Connector



Pin	Signal	Pin	Signal
1	RED	9	CRT_VCC
2	GREEN	10	GND
3	BLUE	11	NC
4	NC	12	DAT_DDC2
5	GND	13	HSYNC

<b>6</b>	<b>GND</b>	<b>14</b>	<b>VSYNC</b>
<b>7</b>	<b>GND</b>	<b>15</b>	<b>CLK_DDC2</b>
<b>8</b>	<b>GND</b>		

---

[Back to Contents Page](#)