

Thank you for purchasing this Factory Service Manual CD/DVD from servicemanuals4u.com.

Please check out our eBay auctions for more great deals on Factory Service Manuals:

[servicemanuals4u](http://servicemanuals4u.com)

Dell™ Latitude™ C610/C510 Service Manual

[Before You Begin](#)

[System Components](#)

[Hard Drive](#)

[Memory Modules, Mini PCI Card, and Modem](#)

[Keyboard](#)

[Display Assembly, Display Latch, and Hinge Covers](#)

[Palm Rest](#)

[Microprocessor Thermal Cooling Assembly](#)

[Microprocessor Module](#)

[Hybrid Cooling Fan](#)

[Reserve Battery](#)

[Flashing the BIOS](#)

[Speaker Assemblies](#)

[System Board](#)

[Battery and Module Bay Latches](#)

[Pin Assignments for I/O Connectors](#)

Notes, Notices, and Cautions



NOTE: A NOTE indicates important information that helps you make better use of your computer.



NOTICE: A NOTICE indicates either potential damage to hardware or loss of data and tells you how to avoid the problem.



CAUTION: A CAUTION indicates a potential for property damage, personal injury, or death.

Information in this document is subject to change without notice.

© 2002 Dell Computer Corporation. All rights reserved.

Trademarks used in this text: *Dell*, the *DELL* logo, and *Latitude* are trademarks of Dell Computer Corporation; *Intel* is a registered trademark of Intel Corporation; *Microsoft* and *Windows* are registered trademarks of Microsoft Corporation.

Other trademarks and trade names may be used in this document to refer to either the entities claiming the marks and names or their products. Dell Computer Corporation disclaims any proprietary interest in trademarks and trade names other than its own.

January 2002 Rev. A01

[Back to Contents Page](#)

Before You Begin

Dell™ Latitude™ C610/C510 Service Manual

- [Preparing to Work Inside the Computer](#)
 - [Recommended Tools](#)
 - [Screw Identification](#)
-

Preparing to Work Inside the Computer



CAUTION: Before working inside your computer, read "Safety and EMC Instructions: Portable Computers" in your *System Information Guide*.



NOTICE: Only a certified service technician should perform repairs on your computer. Damage due to servicing that is not authorized by Dell is not covered by your warranty.



NOTICE: To avoid damaging the computer, perform the following steps before you begin working inside the computer.

1. Make sure that the work surface is clean to prevent scratching the computer cover.
2. Save any work in progress and close all open programs.
3. Turn off the computer and all attached devices.



NOTE: Make sure the computer is turned off and not in suspend-to-disk or hibernate mode. If you cannot shut down the computer using the computer operating system, press and hold the power button for 4 seconds.

4. Make sure the computer is undocked.
5. Disconnect the computer from the electrical outlet.
6. To avoid possible damage to the system board, wait 10 to 20 seconds and then disconnect any attached devices.
7. Disconnect all other external cables from the computer.
8. Remove any installed PC Cards or plastic blanks from the PC Card slot.
9. Close the display and turn the computer upside down on a flat work surface.



NOTICE: To avoid damaging the system board, you must remove the main battery and secondary battery (if present) before you service the computer.

10. Remove the primary battery from the battery bay and the secondary battery from the module bay, if a secondary battery is in use.
 11. Remove any installed device in the module bay.
 12. To dissipate any static electricity while you work, use a wrist grounding strap or periodically touch an unpainted metal surface.
 13. Handle components and cards with care. Do not touch the components or contacts on a card. Hold a card by its edges or by its metal mounting bracket. Hold a component such as a microprocessor by its edges, not by its pins.
-

Recommended Tools

The procedures in this manual require the following tools:

- #1 magnetized Phillips screwdriver
- ¼-inch flat-blade screwdriver
- Small plastic scribe
- Microprocessor extractor
- Flash BIOS update program floppy disk or CD

Computer Orientation

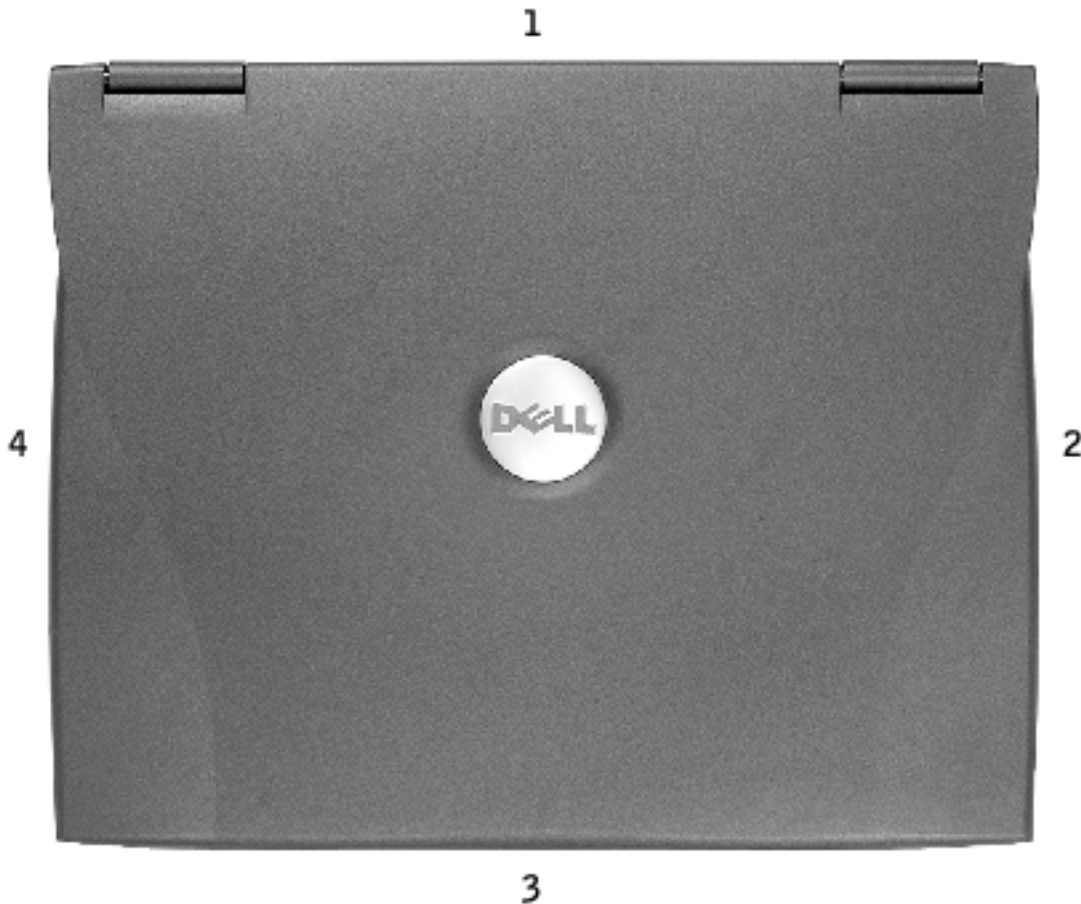

1	back
2	right
3	front
4	left

Screw Identification

When you are removing and replacing components, photocopy the placemat as a tool to lay out and keep track of the screws. The placemat provides the number of screws and their sizes.

Screw Identification

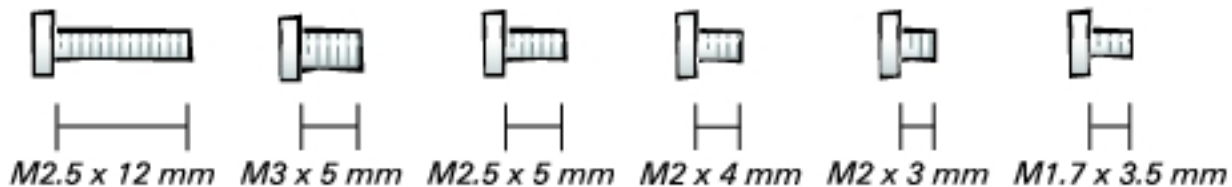

NOTICE: When reinstalling a screw, you must use a screw of the correct diameter and length. Make sure that the screw is properly aligned with its corresponding hole, and avoid over tightening.

Hard Drive Door:

(1 each)

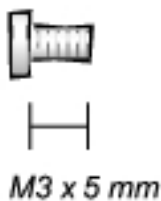

Keyboard to
Bottom Case:

(5 each)



Display Bezel:

(6 each)

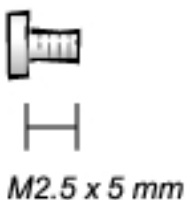

Hinge Bracket to Bottom Case:

(5 each)

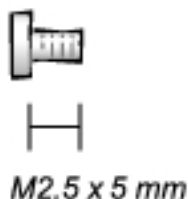

Rubber Screw Covers (6 each)

Display Assembly to Top Cover:

(5 each)



M2 x 4 mm

Display-Feed Flex Cable:

(4 each)



M2 x 3 mm

Palm Rest to Bottom Case:

(5 each) (3 each)



M2 x 3 mm

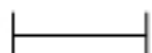

M2.5 x 12 mm

Hybrid Cooling Fan:

(2 each) (1 each)



M2.5 x 5 mm



M2 x 3 mm

System Board to Bottom Case:

(10 each)



M2.5 x 5 mm

Modem to System Board:

(2 each)



M2 x 3 mm

Display Latch:

(2 each) (2 each)



M2.5 x 5 mm



M1.7 x 3.5 mm

Memory Module Cover:

(2 captive screws)

(1 each)

NOTE: The single screw is one of the five keyboard screws.

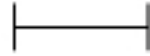

M2.5 x 12 mm



[Back to Contents Page](#)

[Back to Contents Page](#)

System Components

Dell™ Latitude™ C610/C510 Service Manual

Exploded View

-  **NOTICE:** Only a certified service technician should perform repairs on your computer. Damage due to servicing that is not authorized by Dell is not covered by your warranty.
-  **NOTICE:** Unless otherwise noted, each procedure in this manual assumes that a part can be replaced by performing the removal procedure in reverse order.

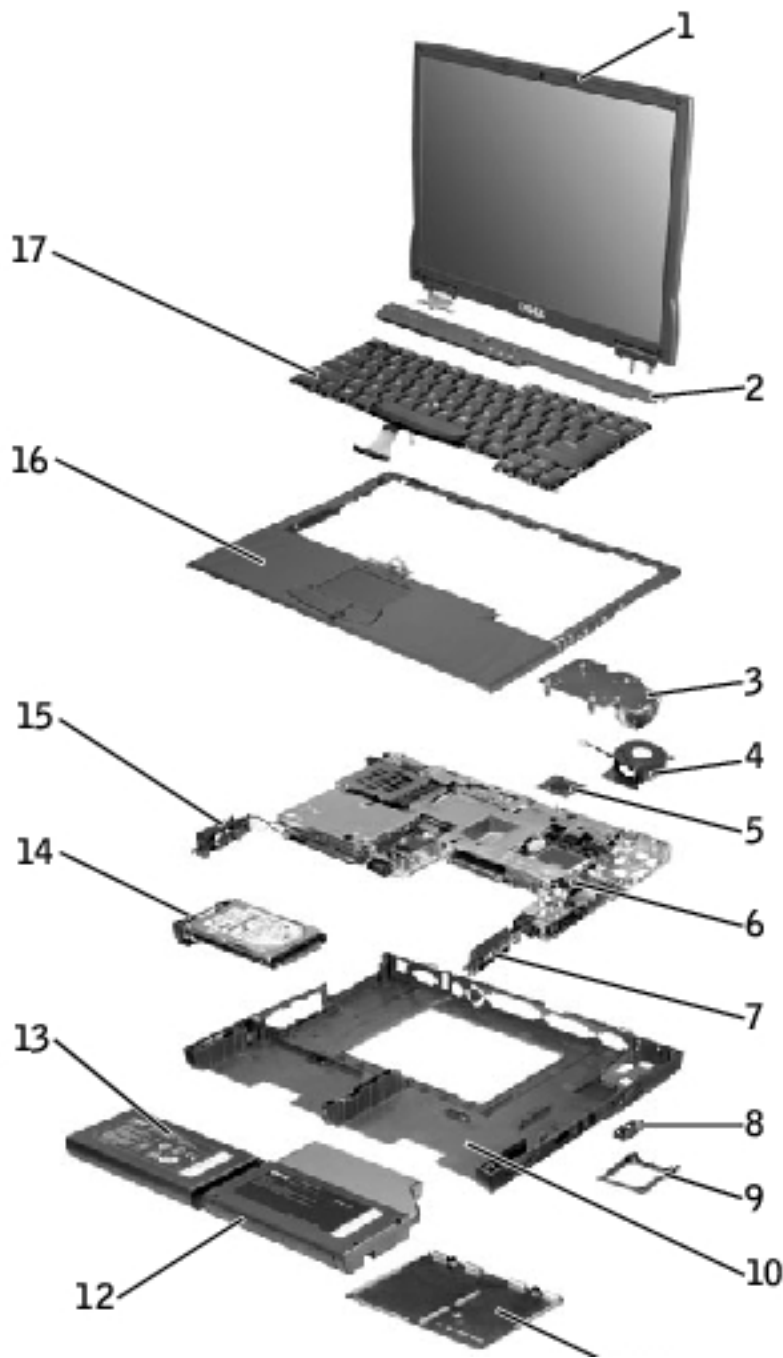

12



11

1	display assembly	10	bottom case
2	center control cover	11	memory module cover
3	microprocessor thermal cooling assembly	12	module bay device
4	hybrid cooling fan	13	main battery
5	microprocessor	14	hard drive
6	system board	15	left speaker
7	right speaker	16	palm rest
8	modem and network-adapter connector covers	17	keyboard
9	fan guard		

[Back to Contents Page](#)

[Back to Contents Page](#)

Hard Drive

Dell™ Latitude™ C610/C510 Service Manual

 [Removing the Hard Drive](#)

 [Replacing the Hard Drive](#)

Removing the Hard Drive

1. Save and close any open files, exit any open programs, and shut down the computer.



NOTICE: Disconnect the computer and any attached devices from electrical outlets, and remove any installed batteries.



NOTICE: The hard drive is very sensitive to shock. Handle the hard drive by its edges (do not squeeze the top of the hard drive case), and avoid dropping it.



NOTICE: Read "[Preparing to Work Inside the Computer](#)" before performing the following procedure.



NOTICE: To prevent data loss, turn off your computer before removing the hard drive. Do not remove the hard drive while the computer is running, in standby mode, or in hibernate mode.



CAUTION: If you remove the hard drive from the computer when the drive is hot, *do not touch* the metal housing of the hard drive.

2. Ground yourself by touching a metal connector on the back of the computer.
3. Turn the computer over. Remove the M3 x 5-mm screw from the hard drive door.

Hard Drive Removal

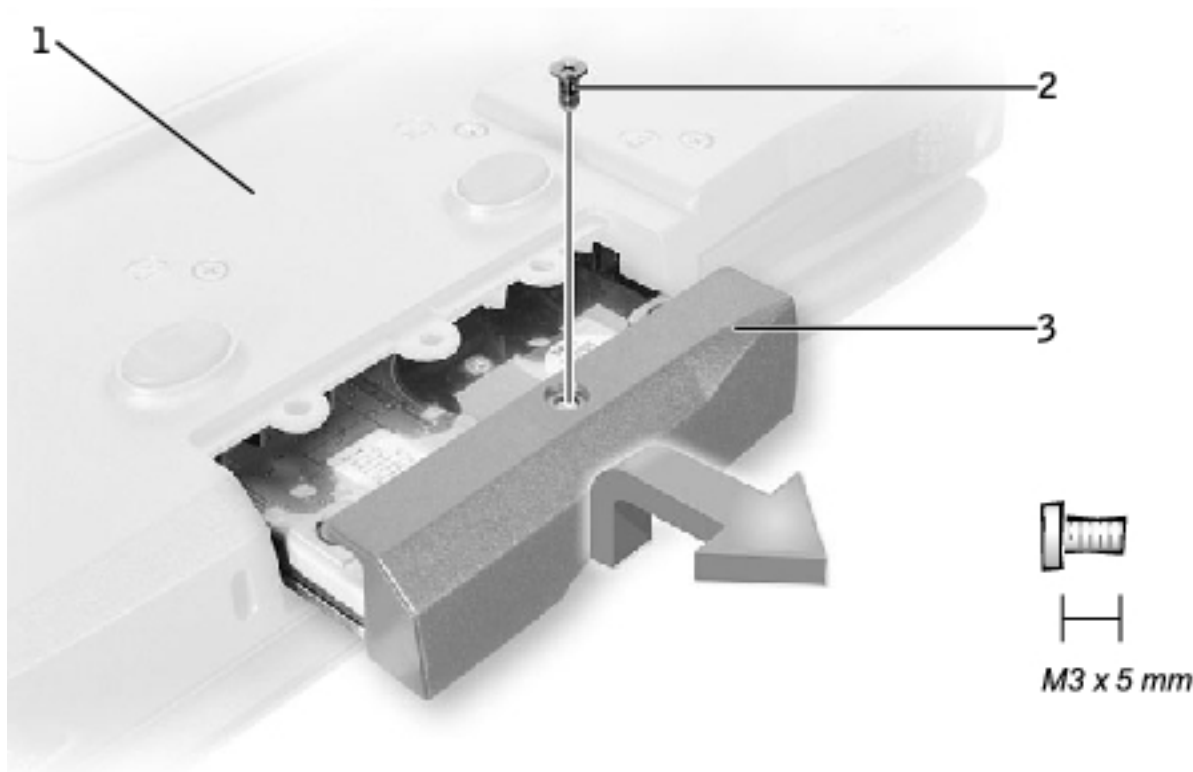

1	bottom of computer
2	M3 x 5-mm screw
3	hard drive door

4. Lift up the hard drive door until you hear a click.
5. Slide the hard drive out of the computer.

Replacing the Hard Drive



NOTICE: Use firm and even pressure to slide the hard drive into place. If you force the hard drive into place using excessive force, you may damage the connector.

1. Lift up the hard drive door until you hear a click. Push the hard drive into the drive bay until it is fully seated in the bay.
2. Press the hard drive door down.
3. Replace the M3 x 5-mm screw in the hard drive door.

[Back to Contents Page](#)

[Back to Contents Page](#)

Memory Modules, Mini PCI Card, and Modem

Dell™ Latitude™ C610/C510 Service Manual



 [Memory Modules](#)

 [Mini PCI Card](#)

 [Modem](#)

Memory Modules

Removing the Memory Module Cover

-  **NOTICE:** Disconnect the computer and any attached devices from electrical outlets, and remove any installed batteries.
 -  **NOTICE:** To avoid ESD, ground yourself by using a wrist grounding strap or by touching an unpainted metal surface on the computer.
 -  **NOTICE:** Read "[Preparing to Work Inside the Computer](#)" before performing the following procedure.
1. Turn the computer over, and use a flat-blade screwdriver to release the two captive screws from the memory module cover.
 2. Remove the M2.5 x 12-mm screw labeled "circle K." (The screw is one of the five keyboard screws.)
 3. Place your finger under the cover at the indentation and lift and slide the cover open.

Memory Module Cover

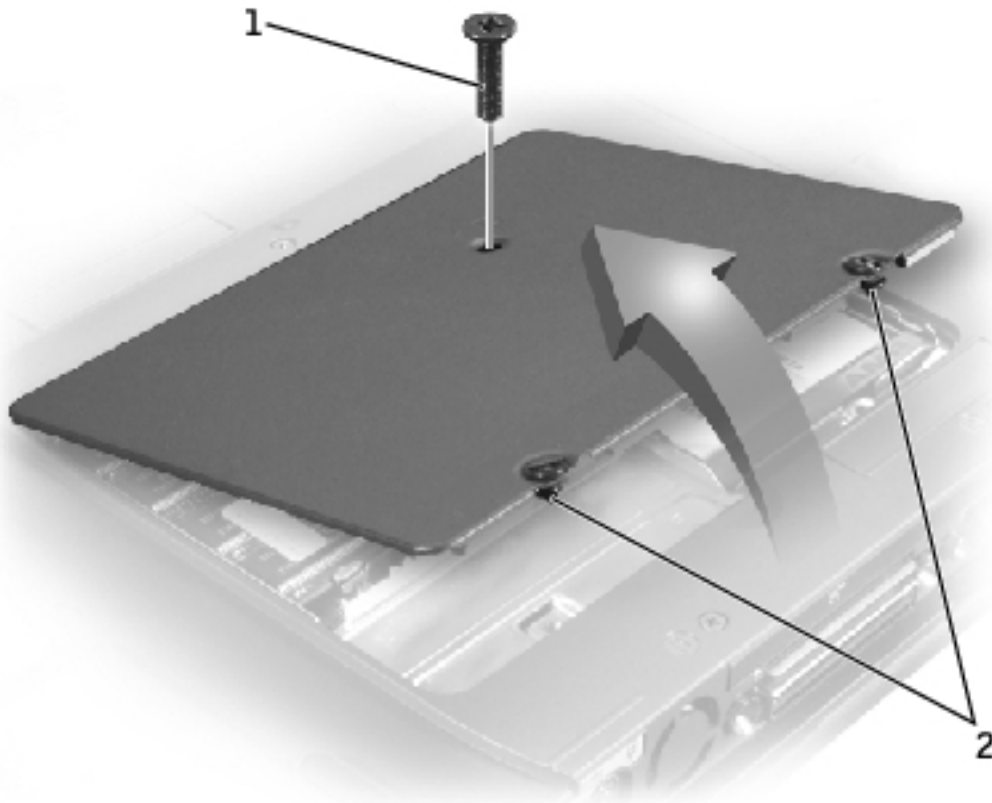

1	M2.5 x 12-mm screw (1)
---	------------------------

2	captive screws (2)
---	--------------------

Removing the Memory Modules

- ➔ **NOTICE:** Disconnect the computer and any attached devices from electrical outlets, and remove any installed batteries.
 - ➔ **NOTICE:** To avoid ESD, ground yourself by using a wrist grounding strap or by touching an unpainted metal surface on the computer.
 - ➔ **NOTICE:** Read "[Preparing to Work Inside the Computer](#)" before performing the following procedure.
1. Remove the [memory module cover](#).
- ➔ **NOTICE:** To prevent damage to the memory module connector, do not use tools to spread the inner metal tabs that secure the memory module.
2. Use your fingertips to carefully spread apart the inner tabs on each end of the memory module socket.

The module should pop up.

Memory Module Removal

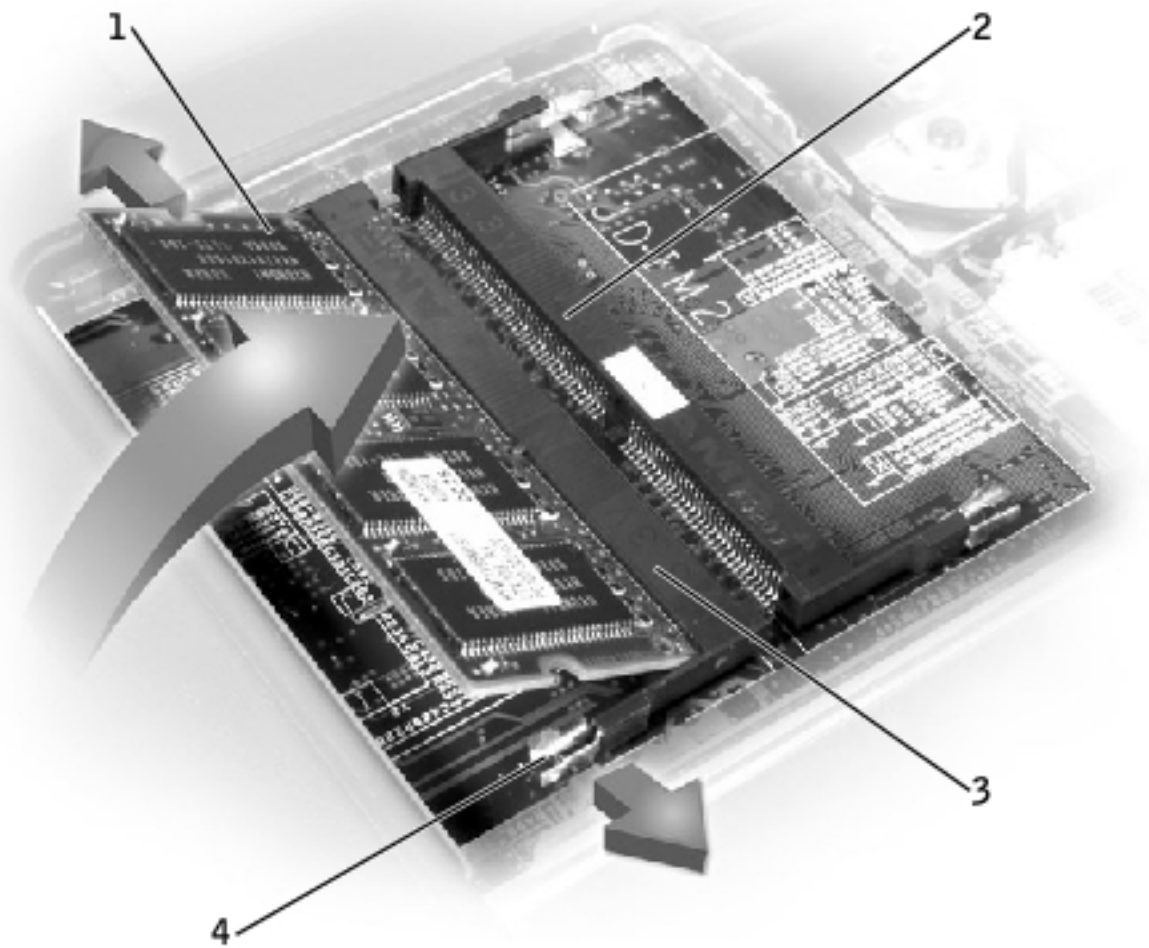

1	JDIM 1
2	JDIM 2
3	memory module sockets (2)
4	inner tabs (2 per socket)

3. Lift the memory module out of its socket.

Replacing the Memory Modules

1. If you only have one memory module, install it in the connector labeled "JDIM1" on the system board. Install a second memory module in the connector labeled "JDIM2."



NOTE: Memory modules are keyed, or designed to fit into their sockets, in only one direction.



NOTICE: The memory module must be inserted at a 45-degree angle to avoid damaging the connector.

2. Align the notch in the memory module with the slot in the center of the socket.
3. Slide the edge connector of the module firmly into the socket at a 45-degree angle, and rotate the module down until you hear a click. If you do not hear the click, remove the module and reinstall it.
4. Replace the cover and tighten the two captive screws.

Mini PCI Card

You must remove the Mini PCI card before the system board can be removed.

Removing the Mini PCI Card



NOTICE: Disconnect the computer and any attached devices from electrical outlets, and remove any installed batteries.



NOTICE: To avoid ESD, ground yourself by using a wrist grounding strap or by touching an unpainted metal surface on the computer.



NOTICE: Read "[Preparing to Work Inside the Computer](#)" before performing the following procedure.

1. Remove the [memory module cover](#).
2. Disconnect the Mini PCI card from the antenna cables.
3. To release a Mini PCI card from its socket, spread apart the metal securing tabs until the card pops up slightly.
4. Lift the Mini PCI card out of its connector.

Mini PCI Card

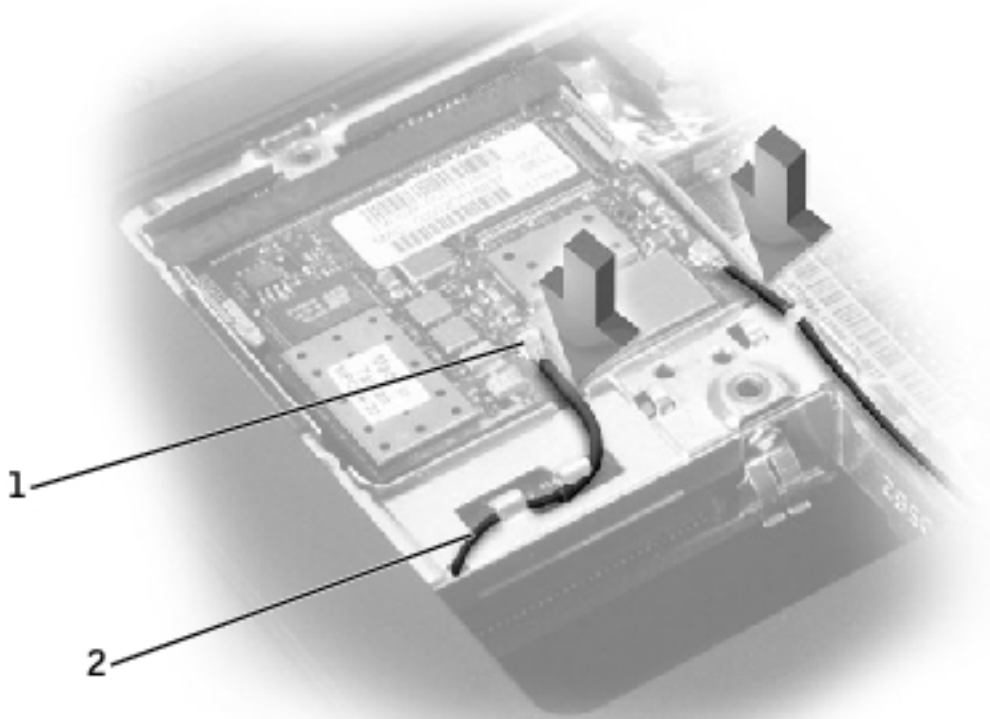

1	antenna connectors on card (2)
2	antenna cables (2)

Replacing the Mini PCI Card

1. Align the Mini PCI card with the socket at a 45-degree angle, and press the Mini PCI card into the socket.







NOTICE: The connectors are keyed for correct insertion; do not force the connections.

2. Lower the Mini PCI card toward the inner tabs to approximately a 20-degree angle.
3. Continue lowering the Mini PCI card until it snaps into the inner tabs of the socket.
4. Attach the antenna cables to the Mini PCI card.
5. Replace the cover and tighten the two captive screws.

Modem

Removing the Modem

-  **NOTICE:** Disconnect the computer and any attached devices from electrical outlets, and remove any installed batteries.
 -  **NOTICE:** To avoid ESD, ground yourself by using a wrist grounding strap or by touching an unpainted metal surface on the computer.
 -  **NOTICE:** Read "[Preparing to Work Inside the Computer](#)" before performing the following procedure.
1. Turn the computer over, and remove the [memory module cover](#).
 2. Remove the two M2 x 3-mm screws that secure the modem to the system board.
-  **NOTICE:** Do not pull on the modem cable. Pull from the modem connector to disconnect the cable.
3. Pull straight up on the attached pull tab to lift the modem out of its connector on the system board and disconnect the modem cable.

Modem Removal

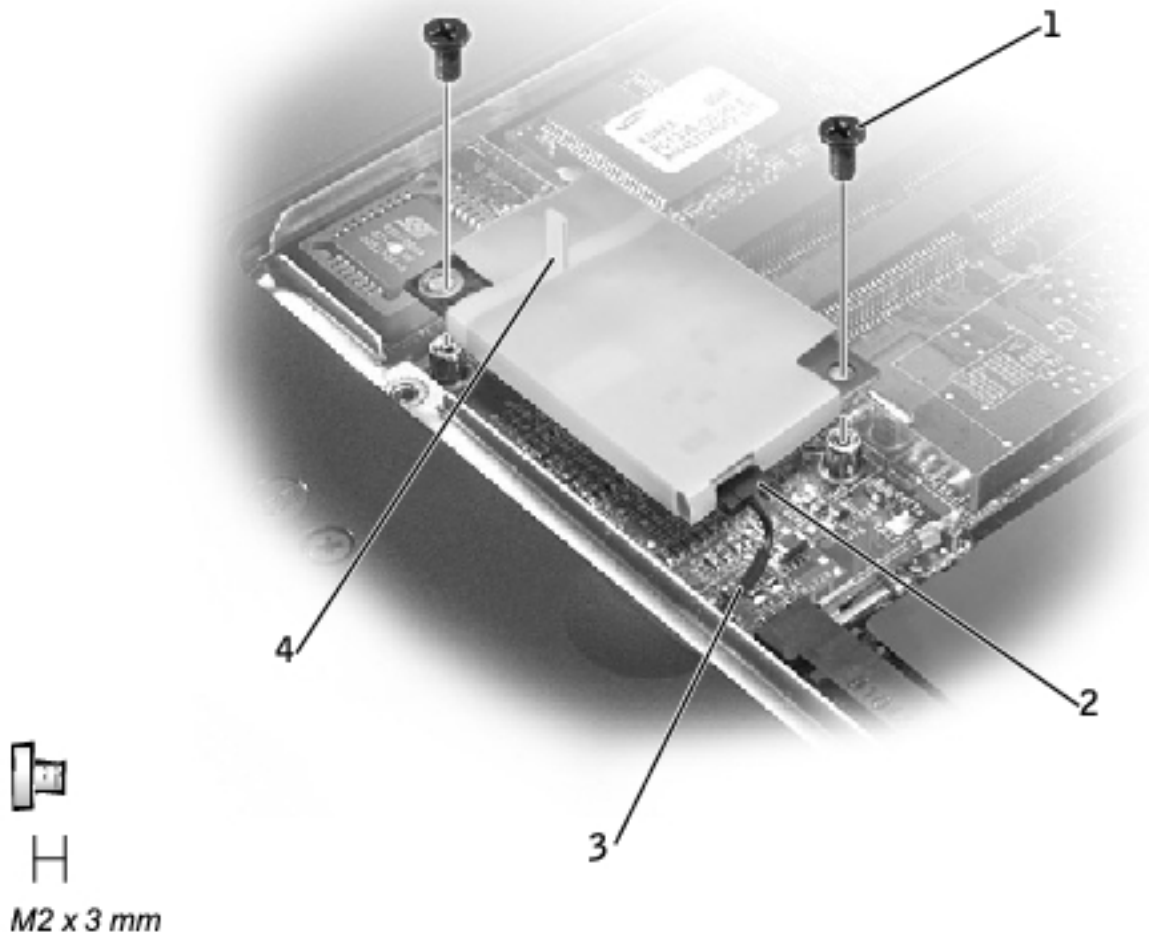

1	M2 x 3-mm screws (2)
2	modem connector
3	modem cable
4	pull tab

Replacing the Modem

1. Connect the modem cable to the modem.



NOTICE: The connectors are keyed for correct insertion; do not force the connections.

2. Align the modem with the screw holes and press the modem into the connector on the system board.
3. Install the two M2 x 3-mm screws that secure the modem to the system board.
4. Replace the [memory module cover](#) and tighten the two captive screws.

[Back to Contents Page](#)

[Back to Contents Page](#)



Keyboard

Dell™ Latitude™ C610/C510 Service Manual

 [Removing the Keyboard](#)

 [Replacing the Keyboard](#)

Removing the Keyboard

-  **NOTICE:** Disconnect the computer and any attached devices from electrical outlets, and remove any installed batteries.
-  **NOTICE:** To avoid ESD, ground yourself by using a wrist grounding strap or by touching an unpainted metal surface on the computer.
-  **NOTICE:** Read "[Preparing to Work Inside the Computer](#)" before performing the following procedure.

1. Remove the [hard drive](#).
2. Turn the computer over, and remove the five M2.5 x 12-mm screws labeled "circle K."

Screw Removal

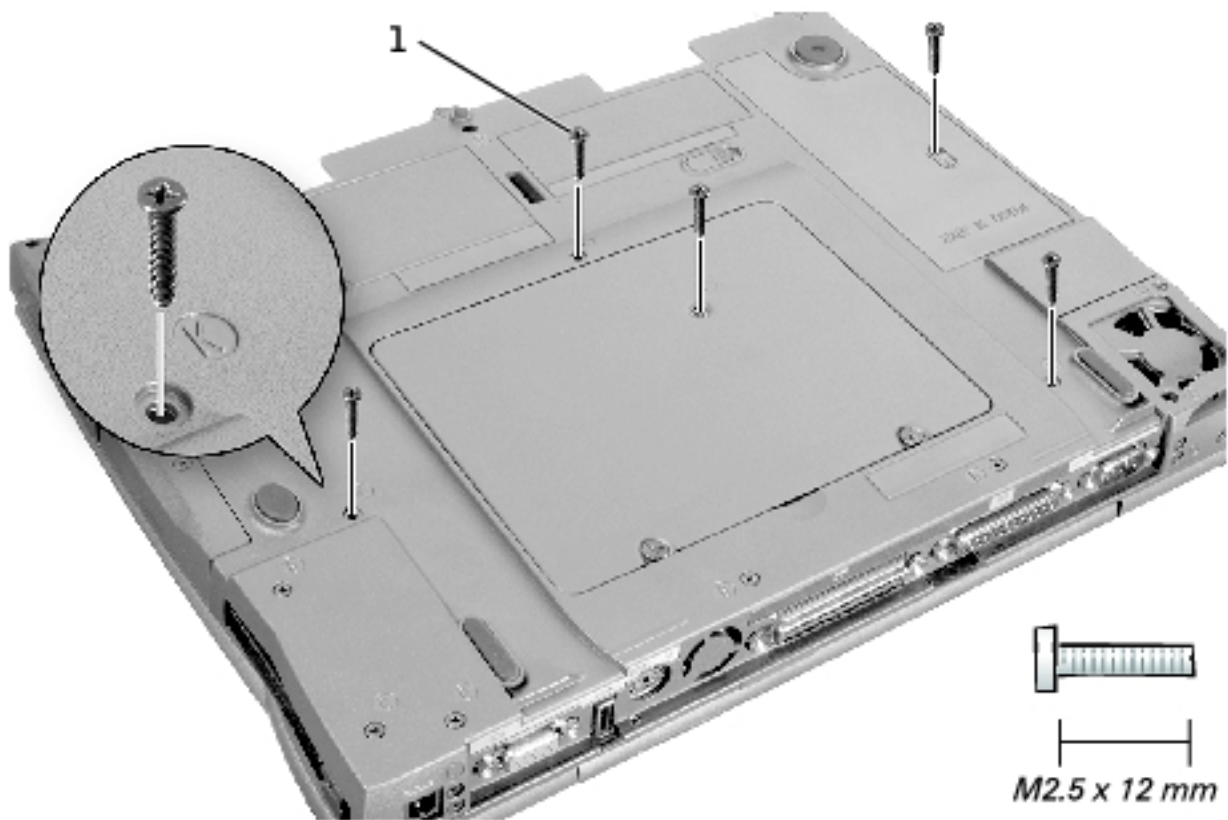

1 M2.5 x 12-mm screws (5)

3. Turn the computer over and open the display.

NOTICE: The key caps on the keyboard are fragile, easily dislodged, and time-consuming to replace. Be careful when removing and handling the keyboard.

4. Remove the center control cover.

- a. Use a small, flat-blade screwdriver or plastic scribe to lift the right edge of the center control cover and pry it loose from the bottom case.
- b. Lift the center control cover up and away from the bottom case.

Center Control Cover Removal



5. To release the keyboard from the palm rest, use a small, flat-blade screwdriver or plastic scribe to pull up on the scalloped edge of the blank key on the keyboard.

Keyboard Removal

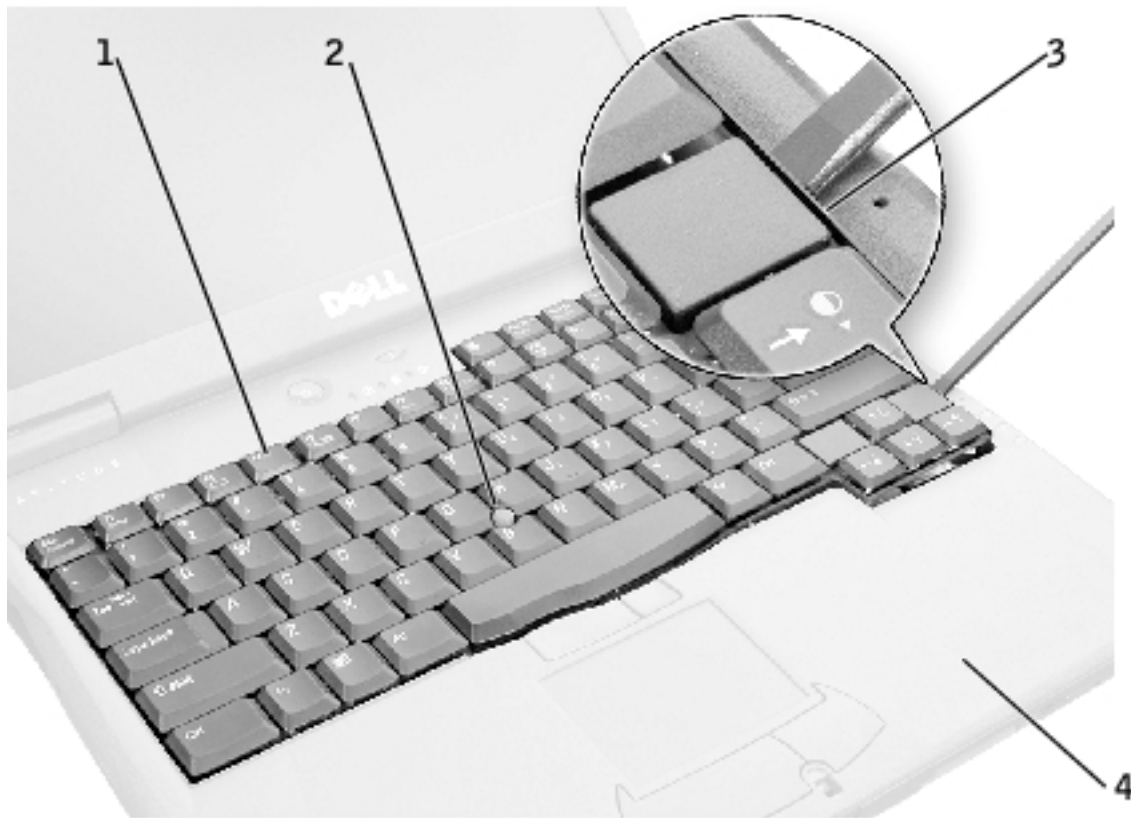

1	keyboard
2	track stick
3	scalloped edge of blank key
4	palm rest

6. Lift the keyboard straight up until it clears the keyboard boss support in the bottom case.
7. Rotate the keyboard forward toward the front of the computer.
8. Rest the key face of the keyboard on the palm rest.

 **NOTICE:** Do not pull on the keyboard flex and track stick cables.

9. Pull up on the keyboard connector to disconnect it from the interface connector on the system board.

Keyboard Connector Removal

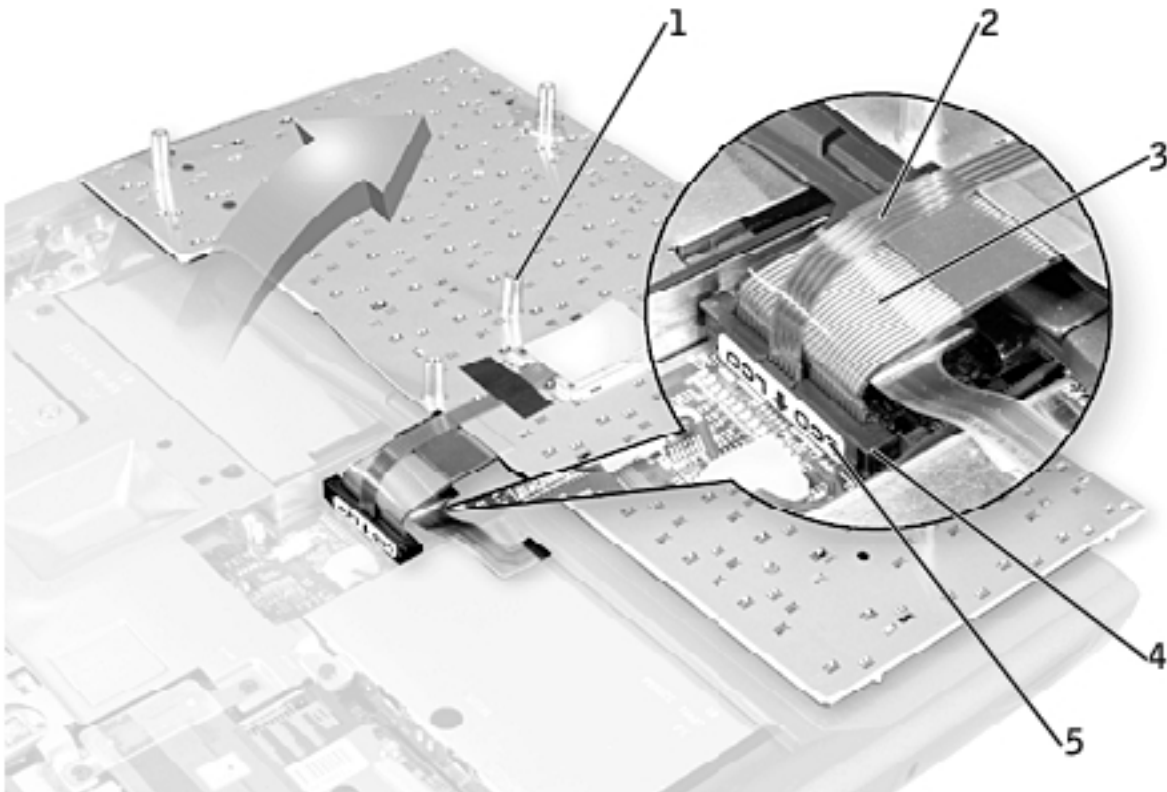

1	boss support (5)
2	track stick cable
3	keyboard flex cable
4	keyboard connector
5	orientation label

10. Remove the keyboard from the bottom case.

Replacing the Keyboard

1. Place the keyboard on the palm rest at the front of the computer with the keys face down and the connector toward the back of the computer.



NOTICE: To avoid damage to the connector pins, press the keyboard connector evenly into the interface connector on the system board, and do not reverse the keyboard connector.

2. Connect the keyboard connector to the interface connector on the system board.

The keyboard connector may have a label on it that shows the correct orientation of the keyboard

connector to the system-board interface connector.

3. Carefully turn the keyboard over. Align the keyboard boss support, fit the left side of the keyboard into place, and then snap the right side of the keyboard into place.



NOTICE: Position the keyboard flex and track stick cables so that they are not pinched when you replace the keyboard in the bottom case.

4. Check that the keyboard is correctly installed. The keys should be flush with the left and right surfaces of the palm rest.
5. Replace the center control cover, close the display assembly, and turn the computer over.
6. Reinstall the five M2.5 x 12-mm screws in the holes labeled "circle K."

[Back to Contents Page](#)

[Back to Contents Page](#)

Display Assembly, Display Latch, and Hinge Covers





Dell™ Latitude™ C610/C510 Service Manual

[Display Assembly](#)

[Display Latch](#)

[Hinge Covers](#)

Display Assembly

-  **NOTICE:** You must remove the display assembly before you remove the palm rest.
-  **NOTICE:** Disconnect the computer and any attached devices from electrical outlets, and remove any installed batteries.
-  **NOTICE:** To avoid ESD, ground yourself by using a wrist grounding strap or by touching an unpainted metal surface on the computer.
-  **NOTICE:** Read "[Preparing to Work Inside the Computer](#)" before performing the following procedure.

Display Assembly

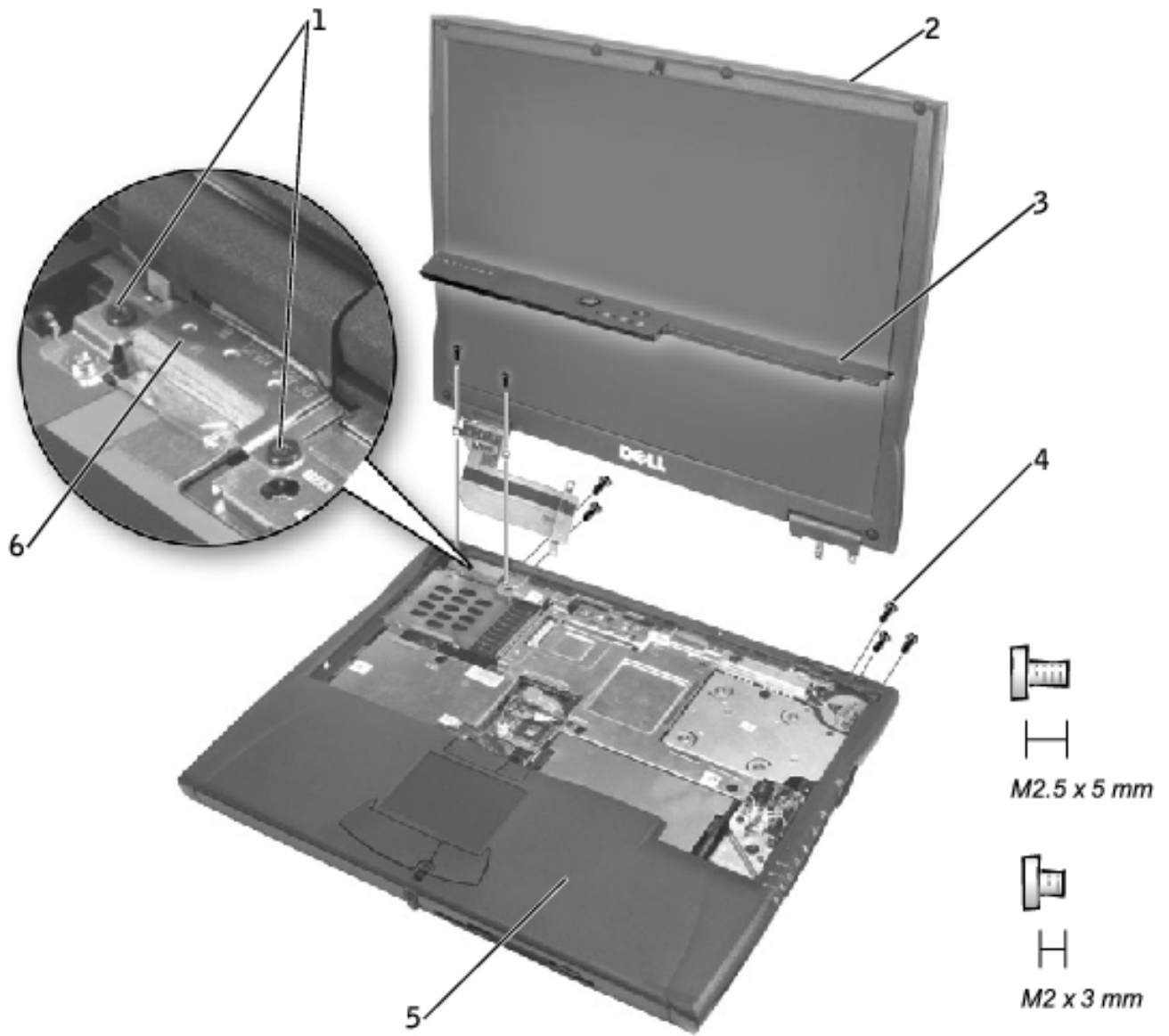

1	M2 x 3-mm screws (4)
2	top cover
3	center control cover
4	M2.5 x 5-mm screws (5)
5	bottom case
6	EMI shield bracket

1. Remove the [hard drive](#).
2. Remove the [center control cover](#).
3. Remove the [keyboard](#).
4. Close the display.
5. From the back of the computer, remove the five M2.5 x 5-mm screws labeled "circle D."

6. Open the display assembly approximately 180 degrees and support the display assembly so that it does not open past this position.
7. Remove the two M2 x 3-mm screws on the EMI shield bracket, which is attached to the display-feed flex cable (see "[Display Assembly](#)").
8. Remove the two M2 x 3-mm screws that secure the display-feed flex cable to the system board (see "[Display-Feed Flex Cable Connector](#)").

Display-Feed Flex Cable Connector

-  **NOTICE:** When reconnecting the display-feed flex cable connector to the system board, push down on the top left and right ends of the connector. Pressing on the center of the connector may damage resistors and compromise EMI protection in the computer.

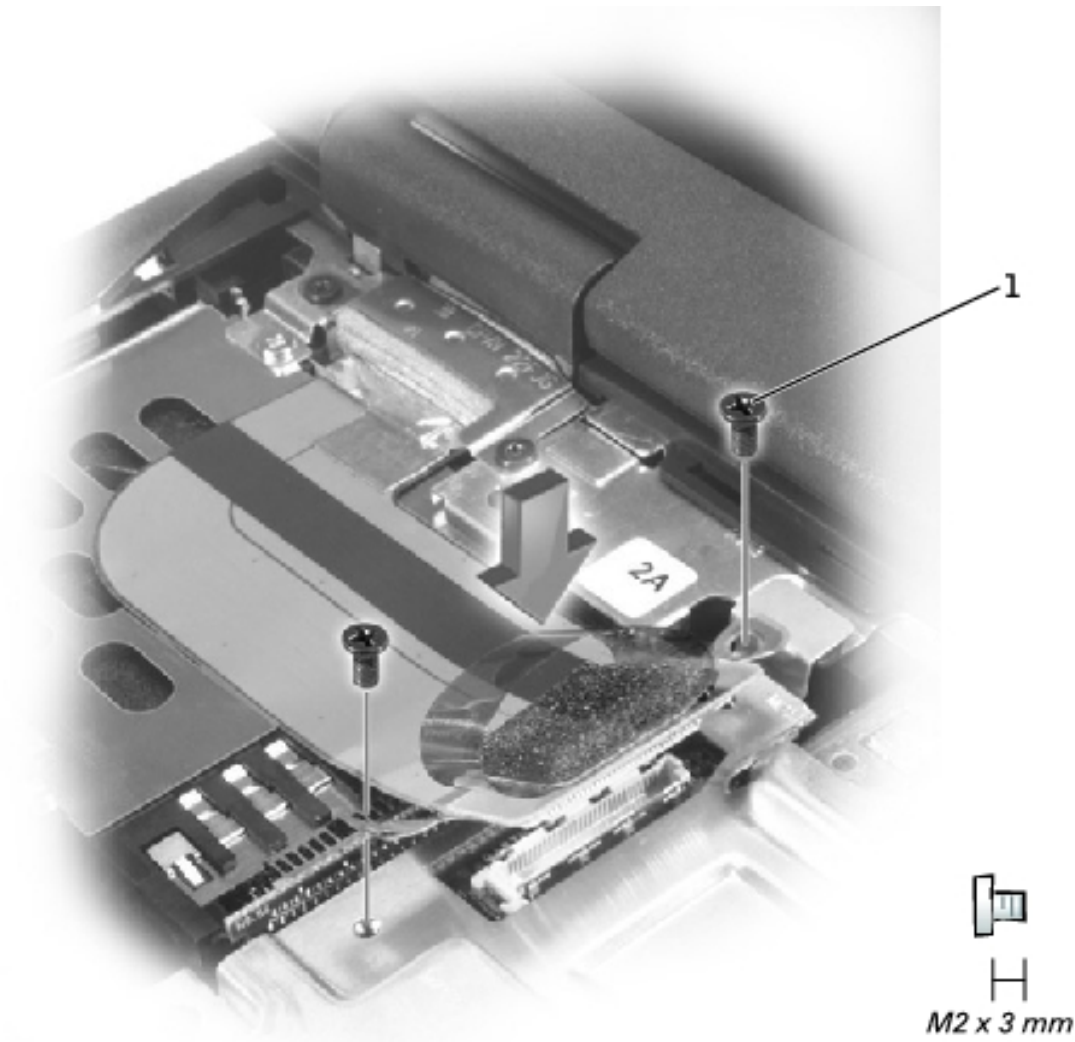

1	M2 x 3-mm screws (2)
---	----------------------

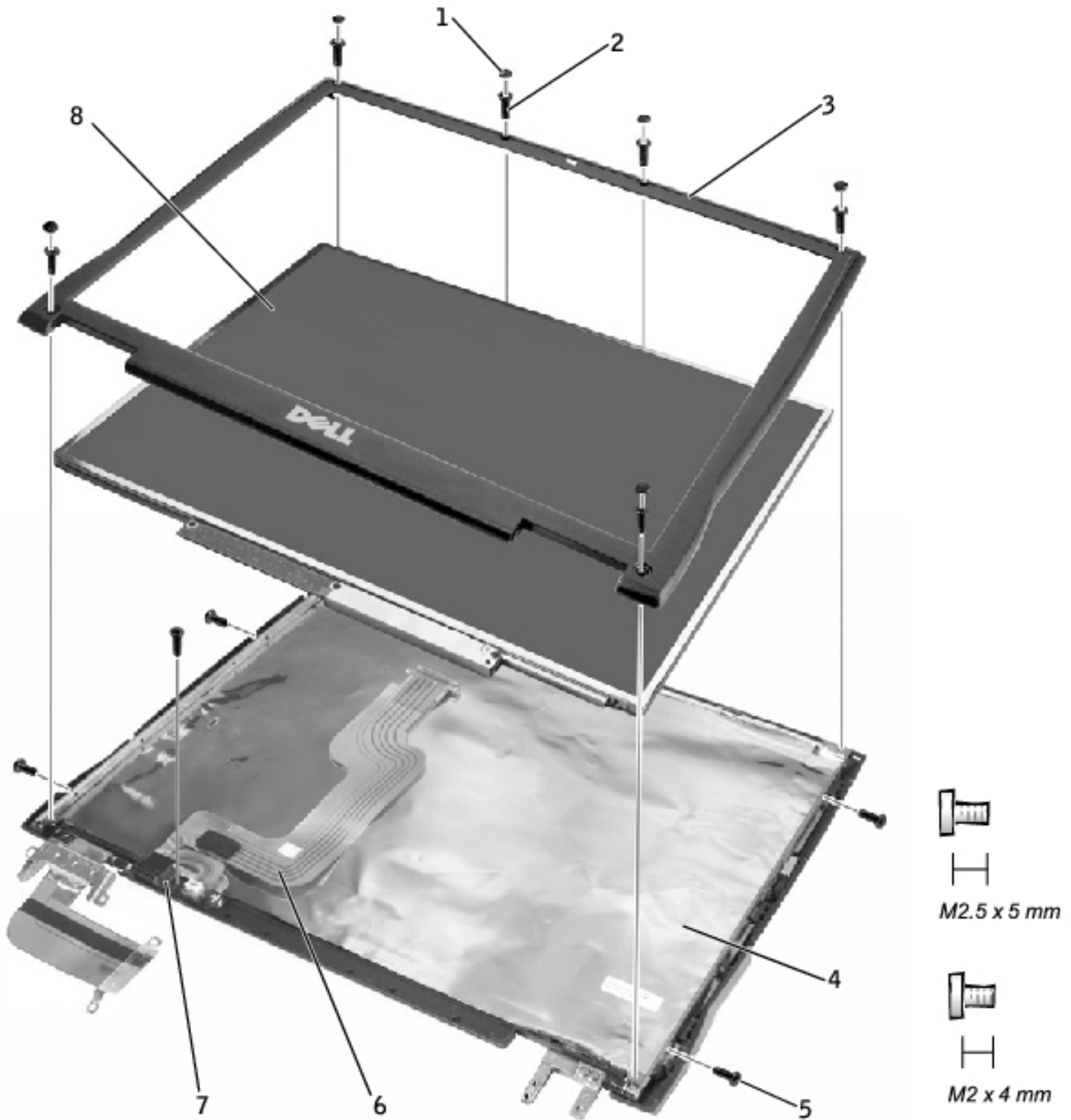

9. Pull up on the pull tab that is attached to the display-feed flex cable connector to remove it from the interface connector on the system board.
10. Lift the display assembly up and out of the bottom case.

14.1-Inch Display Bezel and Panel



1	rubber screw covers (6)	5	M2 x 4-mm screws (5)
2	M2.5 x 5-mm screws (6)	6	display-feed flex cable
3	display bezel	7	flex-cable retention bracket
4	top cover	8	display panel



Removing the 14.1-Inch Display Bezel

-  **NOTICE:** Disconnect the computer and any attached devices from electrical outlets, and remove any installed batteries.
-  **NOTICE:** To avoid ESD, ground yourself by using a wrist grounding strap or by touching an unpainted metal surface on the computer.
-  **NOTICE:** Read "[Preparing to Work Inside the Computer](#)" before performing the following procedure.

1. Remove the [hard drive](#).
2. Remove the [display assembly](#).
3. Use a plastic scribe to pry the six rubber screw covers out of the screw holes located on the front of the bezel.
4. Remove the six M2.5 x 5-mm screws located on the front of the bezel.

-  **NOTICE:** Carefully separate the bezel from the top cover to avoid damage to the bezel.
5. Starting at the bottom of the display panel (by the Dell™ logo), use your fingers to separate the bezel from the top cover by lifting up the inside of the bezel while pushing in on the outside.

Removing the 14.1-Inch Display Panel

-  **NOTICE:** Disconnect the computer and any attached devices from electrical outlets, and remove any installed batteries.
-  **NOTICE:** To avoid ESD, ground yourself by using a wrist grounding strap or by touching an unpainted metal surface on the computer.
-  **NOTICE:** Read "[Preparing to Work Inside the Computer](#)" before performing the following procedure.

1. Remove the [hard drive](#).
2. Remove the [display assembly](#).
3. Remove the [display bezel](#).
4. Remove the [hinge covers](#).
5. Remove the two M2 x 4-mm screws on the left side of the display panel and the two M2 x 4-mm screws on the right side of the display panel.

 **NOTE:** If you have a Hitachi display panel, remove the two M2 x 4-mm screws from the center of the left side of the display panel.

6. Remove the M2 x 4-mm screw that secures the display-feed flex cable to the display assembly through the black plastic flex-cable retention bracket (see "[14.1-Inch Display Bezel and Panel](#)").
7. Lift from the top and rotate the display panel out of the top cover.

8. Disconnect the bottom flex cable connector from the inverter connector by pulling straight up on the attached pull tab (see "[Display-Feed Flex Cable Connections](#)").

Display-Feed Flex Cable Connections

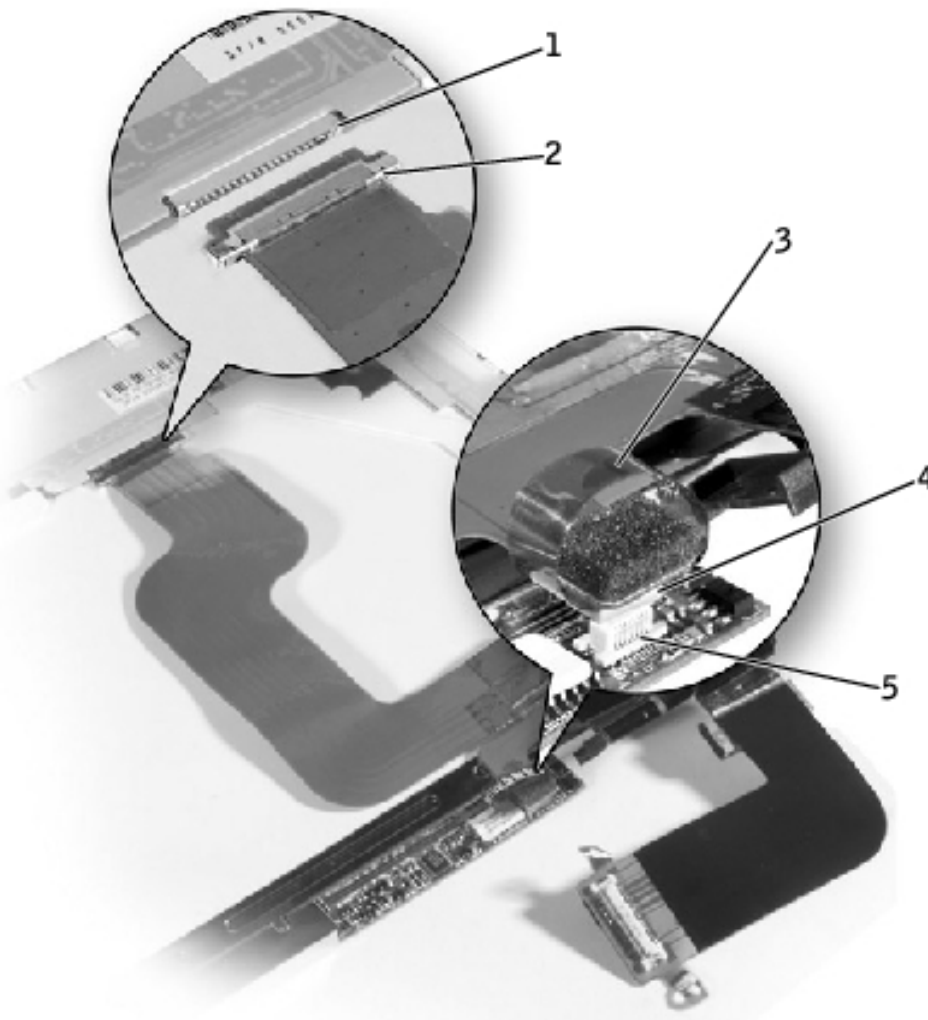

1	display panel connector
2	top flex cable connector
3	pull tab
4	bottom flex cable connector
5	inverter connector

9. Remove the tape that secures the display panel connector and the tape that secures the middle of the display-feed flex cable to the display panel.
10. Pull the top flex cable connector down and away to remove it from the display panel connector.

Replacing the 14.1-Inch Display Panel

1. Reconnect the top flex cable connector to the display panel connector.

2. Reconnect the bottom flex cable connector to the inverter connector.
 3. Replace the tape that secures the display panel connector and the tape that secures the middle of the display-feed flex cable to the display panel.
 4. Place the bottom edge of the display panel in the bottom of the top cover and elevate the top of the panel with your hand.
 5. Lay the display panel in the top cover.
 6. Reinstall the five M2 x 4-mm screws that secure the display panel to the top cover.
-

Display Latch

 **NOTICE:** Disconnect the computer and any attached devices from electrical outlets, and remove any installed batteries.

 **NOTICE:** To avoid ESD, ground yourself by using a wrist grounding strap or by touching an unpainted metal surface on the computer.

Removing the Display Latch

1. Remove the [hard drive](#).
2. Remove the [display assembly](#).
3. Remove the [display bezel](#).
4. Remove the two M2.5 x 5-mm screws and the two M1.7 x 3.5-mm screws that secure the display latch and bracket to the top cover.
5. Lift the display latch and bracket up and out of the top cover.

Display Latch Removal (14.1-Inch XGA Panel Shown)

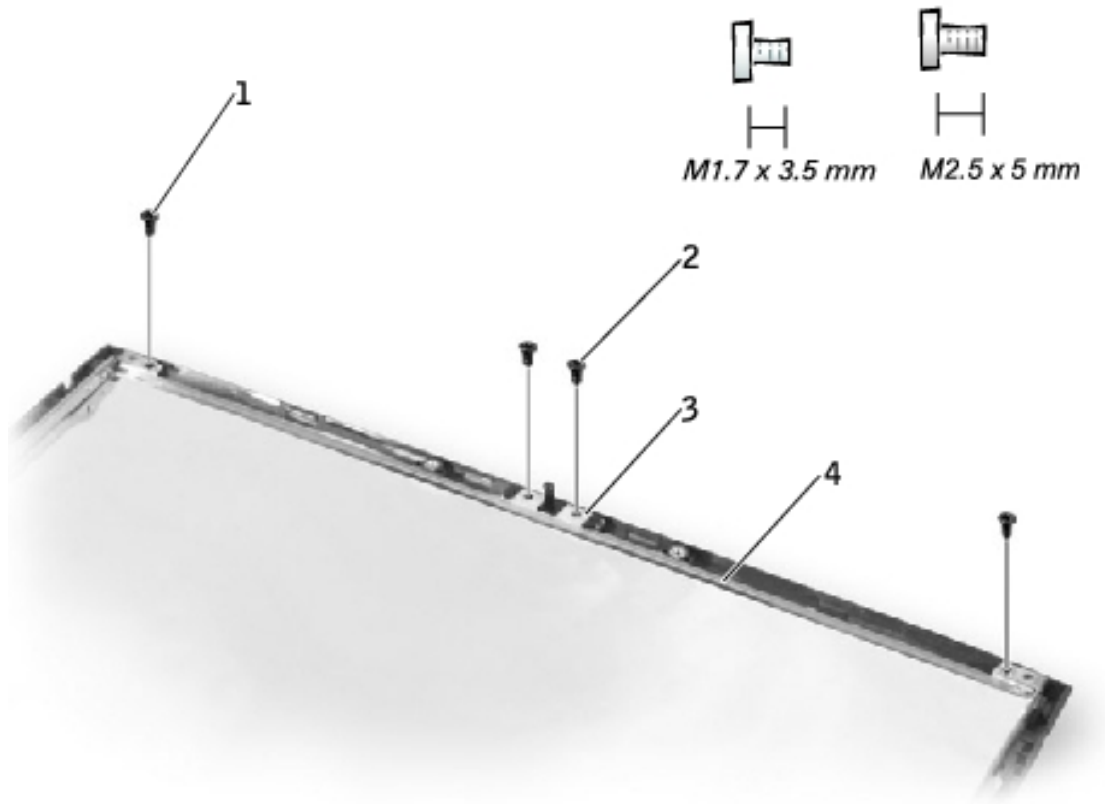

1	M1.7 x 3.5-mm screws (2)
2	M2.5 x 5-mm screws (2)
3	display latch
4	bracket

Replacing the Display Latch

- On 14.1-inch XGA panels, place the display latch on top of its screw holes, and then place the bracket on top of the display latch, aligning the bracket and display latch screw holes.

On 14.1-inch SXGA+ panels, align the screw holes and place the display latch and attached bracket in the top cover.
- Replace the two M2.5 x 5-mm screws and the two M1.7 x 3.5-mm screws that secure the display latch and bracket to the top cover.

Hinge Covers

Removing the Hinge Covers

- Remove the [display assembly](#).

2. Rotate the hinges forward at an angle of approximately 90 degrees to the front of the display assembly.
3. To remove the hinge covers, slide them off the hinges.

Hinge Cover Removal

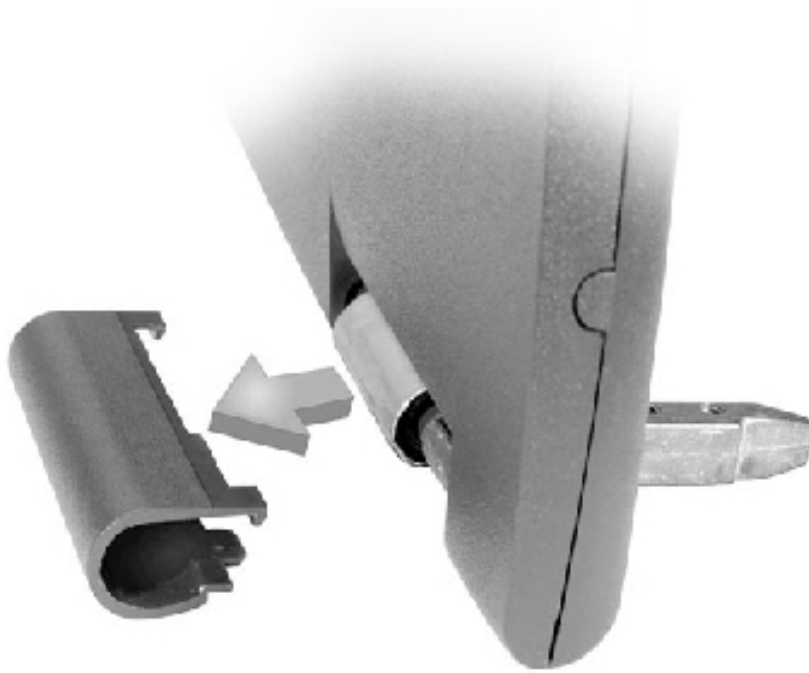

Replacing the Hinge Covers

1. Attach the display assembly to the bottom case.
2. Close the display assembly.
3. Snap the hinge covers in place over the hinges.

 **NOTE:** The right plastic hinge cover label includes an "R," and the left plastic hinge cover label includes an "L." The hinge cover labels face the back of the computer.

Hinge Cover Replacement

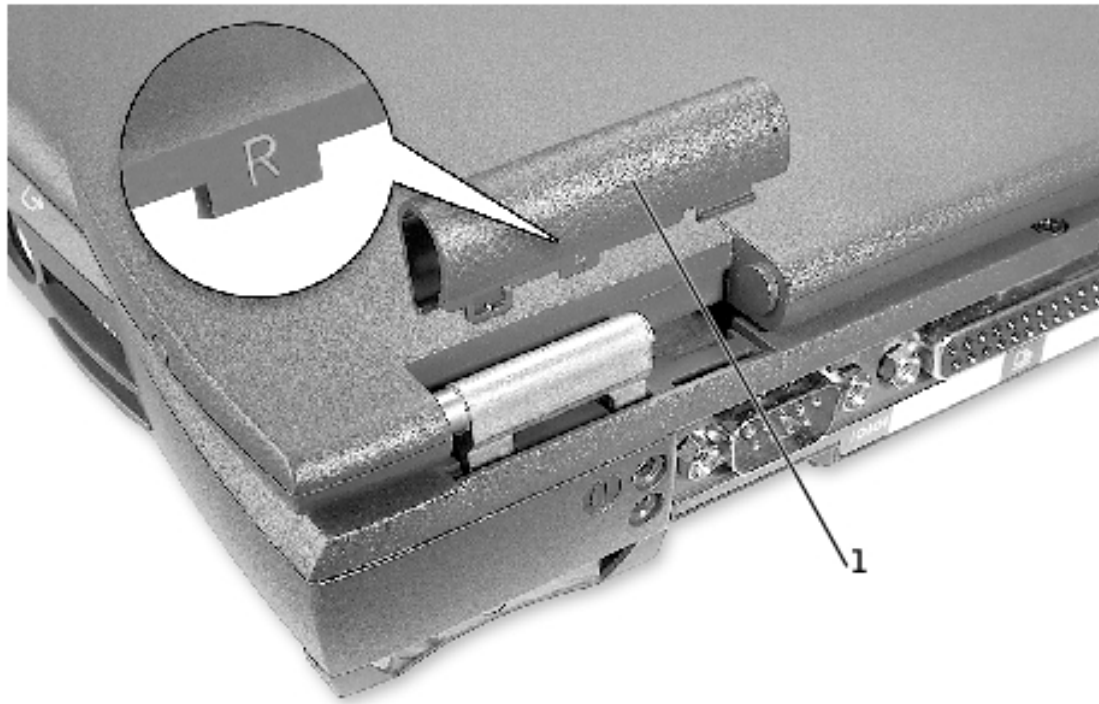

1	right hinge cover
2	left hinge cover

[Back to Contents Page](#)





[Back to Contents Page](#)

Palm Rest

Dell™ Latitude™ C610/C510 Service Manual

 [Removing the Palm Rest](#)

Removing the Palm Rest

-  **NOTICE:** Disconnect the computer and any attached devices from electrical outlets, and remove any installed batteries.
-  **NOTICE:** To avoid ESD, ground yourself by using a wrist grounding strap or by touching an unpainted metal surface on the computer.
-  **NOTICE:** Read "[Preparing to Work Inside the Computer](#)" before performing the following procedure.
 1. Remove the [hard drive](#).
 2. Remove the [keyboard](#).
-  **NOTICE:** You must remove the display assembly before you remove the palm rest; the display hinges pass through the back of the palm rest.
 3. Remove the [display assembly](#) and [hinge covers](#).
 4. Turn the computer over and remove the three M2.5 x 12-mm screws labeled "circle P."

Palm Rest Screw Removal

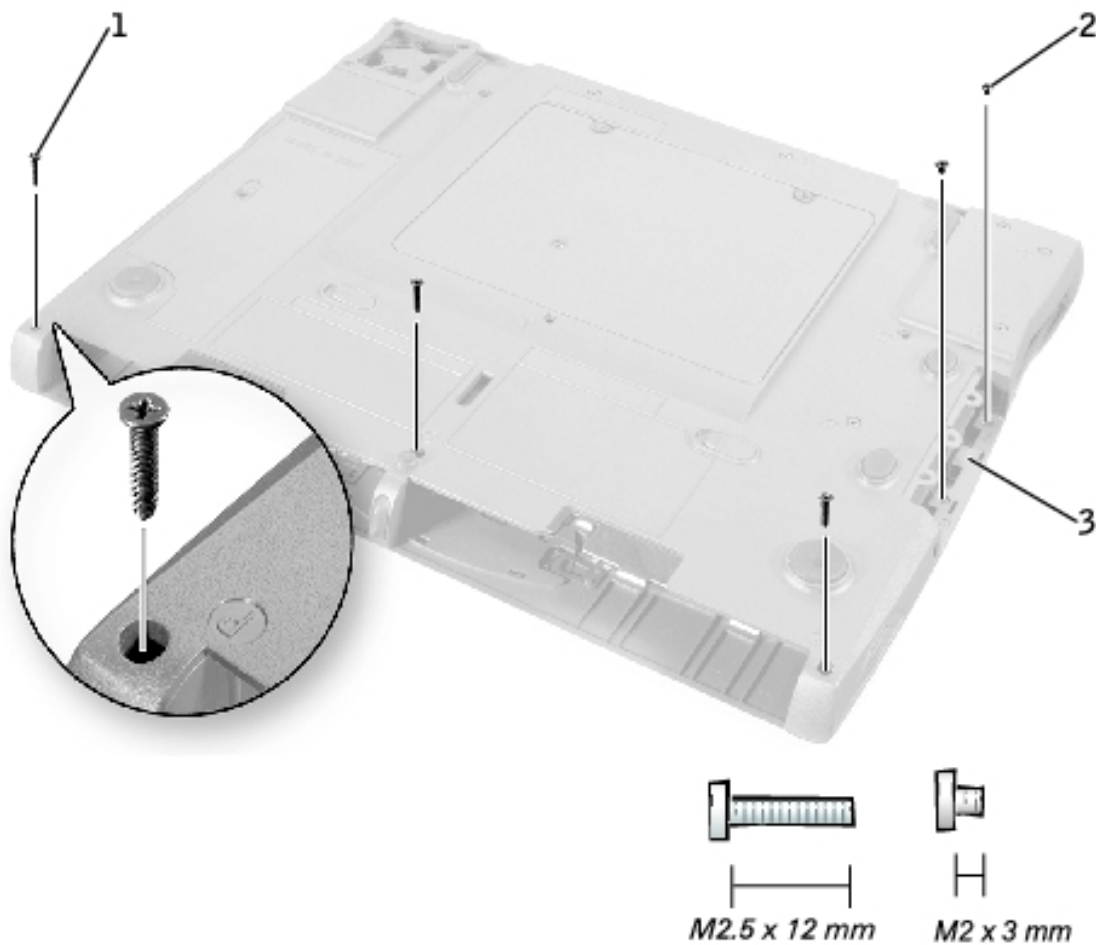

1	M2.5 x 12-mm screws (3)
2	M2 x 3-mm screws (2)
3	hard-drive bay door

5. Remove the two M2 x 3-mm screws that are located in the hard-drive bay door labeled "circle P."
6. Turn the computer over, and remove the three M2 x 3-mm screws that secure the palm rest to the bottom case.
 - a. Remove the two M2 x 3-mm screws that are located on the back edge of the bottom case, underneath the display assembly.
 - b. Remove the M2 x 3-mm screw located underneath the keyboard, on the right side of the bottom case, next to the microprocessor thermal cooling assembly.
7. Pull up on the pull tab that is attached to the palm-rest flex cable connector to remove it from the interface connector on the system board.

Palm Rest Removal

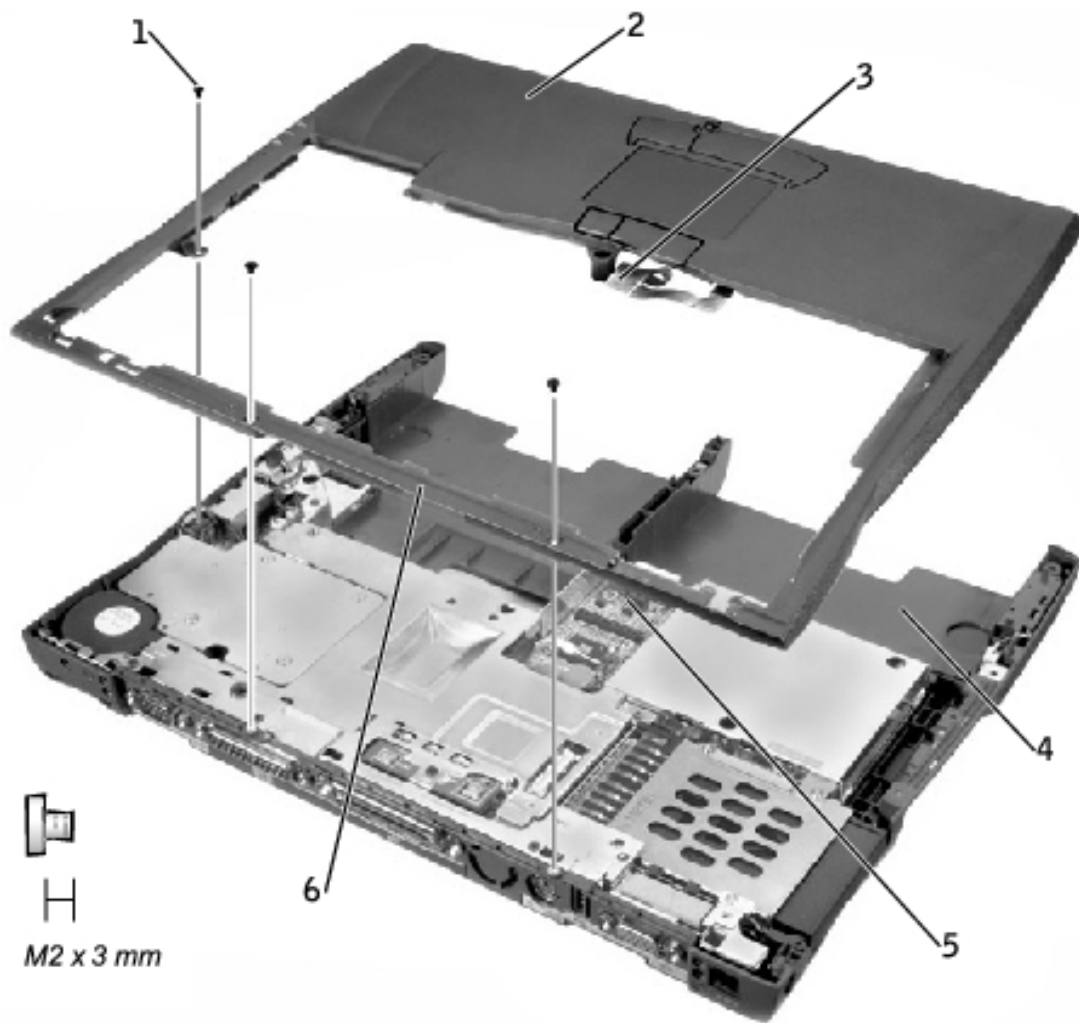

1	M2 x 3-mm screws (3)
2	palm rest
3	palm-rest flex cable
4	bottom case
5	touch pad connector
6	back center of the palm rest

NOTICE: Carefully separate the palm rest from the bottom case to avoid damage to the palm rest.

8. Starting at the back center of the palm rest, use your fingers to separate the palm rest from the bottom case by lifting up the inside of the palm rest while pushing in on the outside.

[Back to Contents Page](#)



[Back to Contents Page](#)

Microprocessor Thermal Cooling Assembly

Dell™ Latitude™ C610/C510 Service Manual

- [Removing the Microprocessor Thermal Cooling Assembly](#)
 - [Replacing the Microprocessor Thermal Cooling Assembly](#)
-

Removing the Microprocessor Thermal Cooling Assembly

-  **NOTICE:** Disconnect the computer and any attached devices from electrical outlets, and remove any installed batteries.
 -  **NOTICE:** To avoid ESD, ground yourself by using a wrist grounding strap or by touching an unpainted metal surface on the computer.
 -  **NOTICE:** Read "[Preparing to Work Inside the Computer](#)" before performing the following procedure.
1. Remove the [hard drive](#).
 2. Remove the [keyboard](#).
 3. Loosen the four captive screws that secure the microprocessor thermal cooling assembly to the system board.

Microprocessor Thermal Cooling Assembly Removal

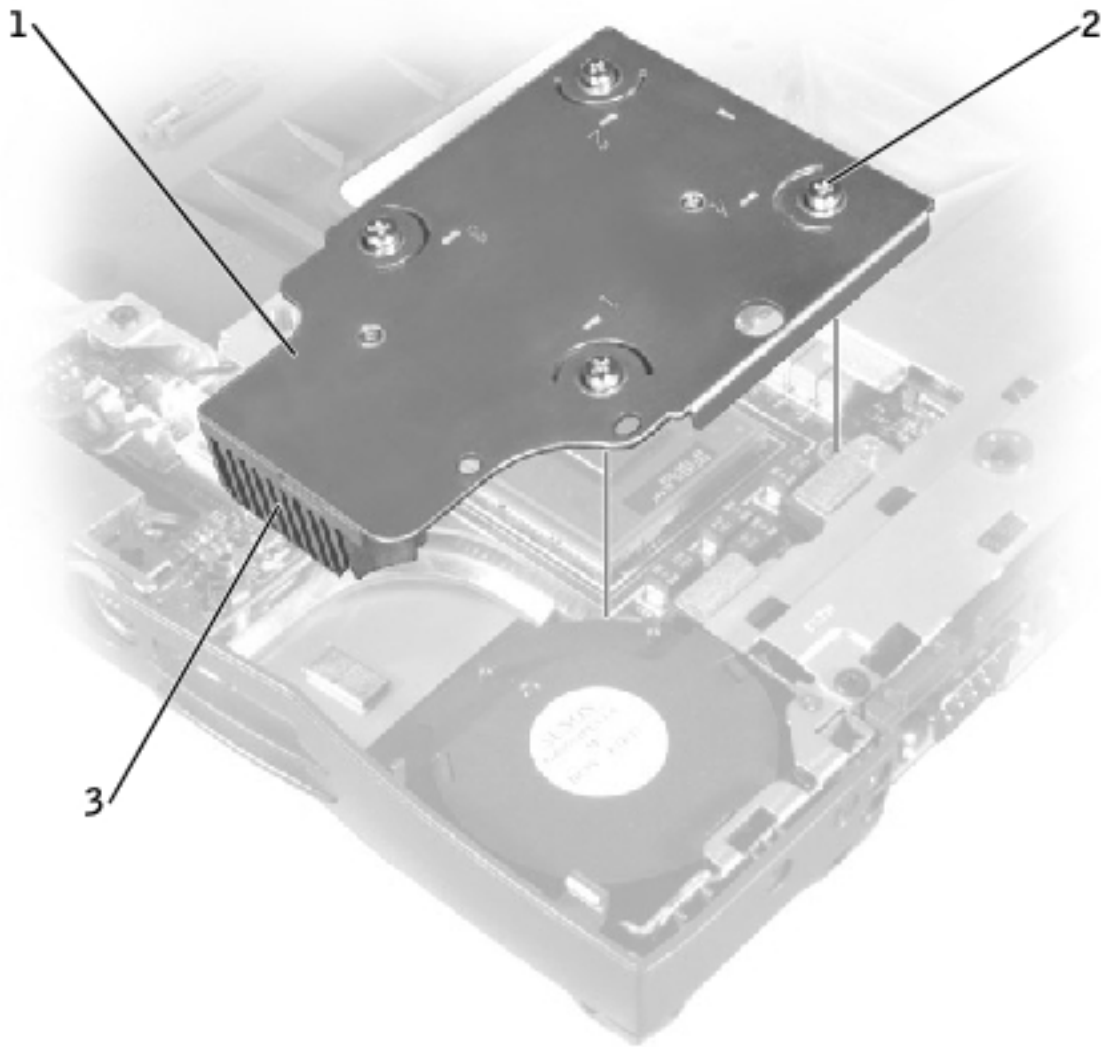

1	microprocessor thermal cooling assembly
2	captive screws (4)
3	right side

4. Lift the microprocessor thermal cooling assembly up and out of the system board.

Replacing the Microprocessor Thermal Cooling Assembly

1. Place the right side of the microprocessor thermal cooling assembly under the palm rest and lower the assembly onto the system board.
2. Tighten the four captive screws, labeled 1 through 4, in consecutive order.

[Back to Contents Page](#)



[Back to Contents Page](#)

Microprocessor Module



Dell™ Latitude™ C610/C510 Service Manual

- [Removing the Microprocessor Module](#)
 - [Replacing the Microprocessor Module](#)
-

Removing the Microprocessor Module

-  **NOTICE:** Disconnect the computer and any attached devices from electrical outlets, and remove any installed batteries.
-  **NOTICE:** To avoid ESD, ground yourself by using a wrist grounding strap or by touching an unpainted metal surface on the computer.
-  **NOTICE:** Read "[Preparing to Work Inside the Computer](#)" before performing the following procedure.

Microprocessor Module Removal

-  **NOTICE:** Do not touch the processor die. Press and hold the microprocessor down on the substrate on which the die is mounted while turning the cam screw to prevent intermittent contact between the cam screw and microprocessor.
-  **NOTICE:** To avoid damage to the microprocessor, hold the screwdriver so that it is perpendicular to the microprocessor when turning the cam screw.

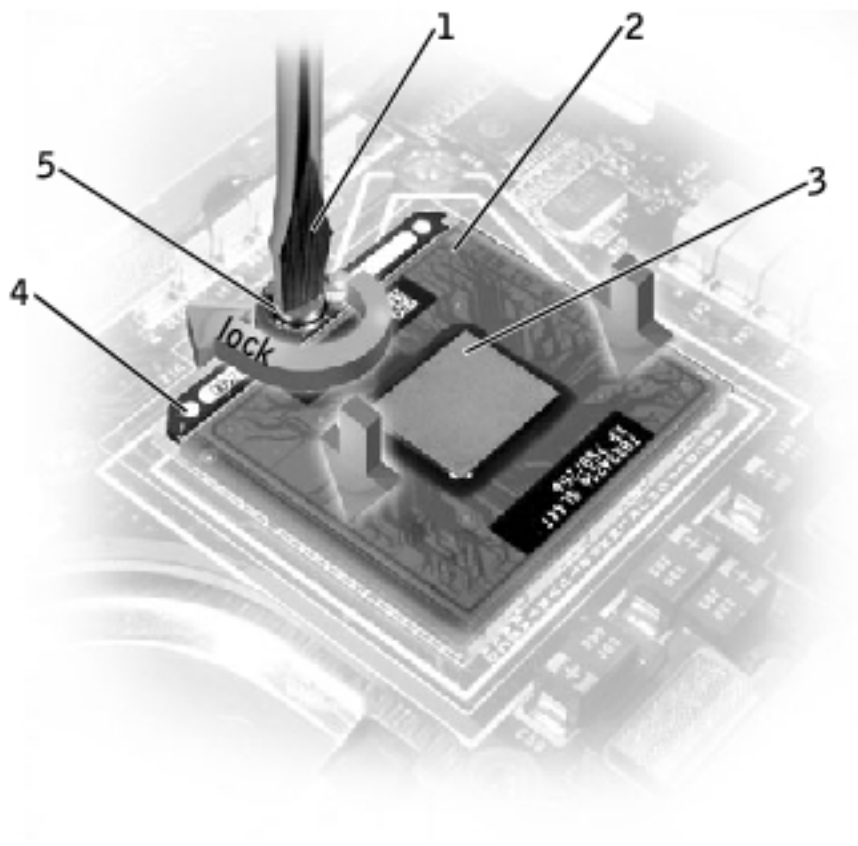

1	screwdriver (perpendicular to microprocessor)
2	pin-1 corner
3	processor die (do not touch)
4	ZIF socket
5	ZIF-socket cam screw

1. Remove the [hard drive](#).
2. Remove the [keyboard](#).

NOTICE: To ensure maximum cooling for the microprocessor, do not touch the heat transfer areas on the microprocessor thermal cooling assembly. The oils in your skin reduce the heat transfer capability of the thermal pads.

3. Remove the [microprocessor thermal cooling assembly](#).

NOTICE: When removing the microprocessor module, pull the module straight up. Be careful not to bend the pins on the microprocessor module.

4. To loosen the ZIF socket, use a small, flat-blade screwdriver and rotate the ZIF-socket cam screw counter-clockwise until it comes to the cam stop.

The ZIF-socket cam screw secures the microprocessor to the system board. Take note of the arrow on the ZIF-socket cam screw (see "[Microprocessor Module Removal](#)").

5. Use a microprocessor extraction tool to remove the microprocessor module.
-

Replacing the Microprocessor Module

 **NOTICE:** Ensure that the cam lock is in the fully open position before seating the microprocessor module. Seating the microprocessor module properly in the ZIF socket does not require force.

 **NOTICE:** A microprocessor module that is not properly seated can result in an intermittent connection, or permanent damage to the microprocessor and ZIF socket.

1. Align the pin-1 corner of the microprocessor module with the pin-1 corner of the ZIF socket, and insert the microprocessor module.

 **NOTE:** The pin-1 corner of the microprocessor module has a triangle that aligns with the triangle on the pin-1 corner of the ZIF socket.

 **NOTICE:** You must position the microprocessor module correctly in the ZIF socket to avoid permanent damage to the module and the socket.

When the microprocessor module is correctly seated, all four corners are aligned at the same height. If one or more corners of the module are higher than the others, the module is not seated correctly.

 **NOTICE:** Hold the microprocessor down while turning the cam screw to prevent intermittent contact between the cam screw and microprocessor (see "[Microprocessor Module Removal](#)").

2. Tighten the ZIF socket by turning the cam screw clockwise to secure the microprocessor module to the system board.
 3. Update the BIOS using a flash BIOS update program floppy disk or CD. For instructions on how to flash the BIOS, see "[Flashing the BIOS.](#)"
-

[Back to Contents Page](#)



[Back to Contents Page](#)

Hybrid Cooling Fan

Dell™ Latitude™ C610/C510 Service Manual

 [Removing the Hybrid Cooling Fan](#)

Removing the Hybrid Cooling Fan

-  **NOTICE:** Disconnect the computer and any attached devices from electrical outlets, and remove any installed batteries.
 -  **NOTICE:** To avoid ESD, ground yourself by using a wrist grounding strap or by touching an unpainted metal surface on the computer.
 -  **NOTICE:** Read "[Preparing to Work Inside the Computer](#)" before performing the following procedure.
1. Remove the [hard drive](#).
 2. Remove the [keyboard](#).
 3. Remove the [display assembly](#).
 4. Remove the [palm rest](#).
 5. Remove the [microprocessor thermal cooling assembly](#).
 6. Remove the two M2.5 x 5-mm screws and one M2 x 3-mm screw that secure the hybrid cooling fan to the system board.

Hybrid Cooling Fan Removal

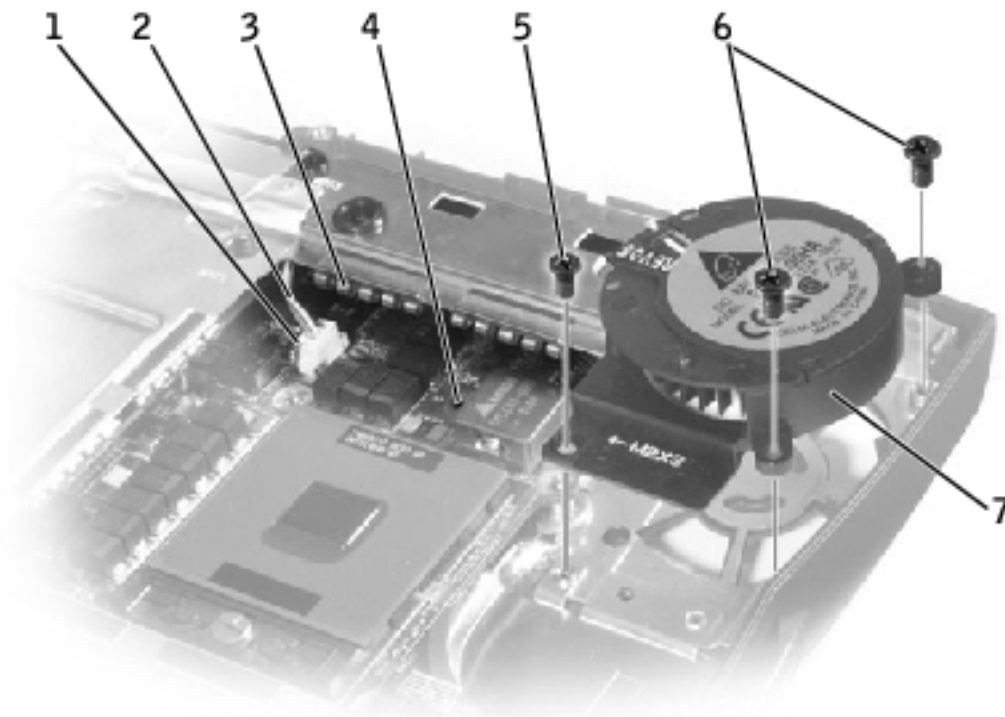

M2.5 x 5 mm



M2 x 3 mm

1	system-board interface connector	5	M2 x 3-mm screw (1)
2	fan power cable	6	M2.5 x 5-mm screws (2)
3	spring fingers	7	hybrid cooling fan
4	keyboard screw hole		

7. Disconnect the fan power cable from the system-board interface connector and remove the hybrid cooling fan.



NOTE: The fan power cable is long, and can be pulled out from under the EMI shield to provide access to the connector.



NOTICE: Do not block the keyboard screw hole when reinstalling the fan. Route the fan power cable under the spring fingers and behind the keyboard screw hole to prevent damage to the fan power cable.

[Back to Contents Page](#)

[Back to Contents Page](#)





Reserve Battery

Dell™ Latitude™ C610/C510 Service Manual

[Removing the Reserve Battery](#)

[Replacing the Reserve Battery](#)

Removing the Reserve Battery

-  **NOTICE:** The reserve battery provides power to the computer's RTC and NVRAM when the computer is turned off. Removing the battery causes the computer to lose the date and time information as well as all user-specified parameters in the BIOS. If possible, make a copy of this information before you remove the reserve battery.
-  **NOTICE:** Disconnect the computer and any attached devices from electrical outlets, and remove any installed batteries.
-  **NOTICE:** To avoid ESD, ground yourself by using a wrist grounding strap or by touching an unpainted metal surface on the computer.
-  **NOTICE:** Read "[Preparing to Work Inside the Computer](#)" before performing the following procedure.

1. Remove the [hard drive](#).
2. Remove the [keyboard](#).
3. Disconnect the reserve battery cable from the system board connector.
4. Pry the reserve battery free from the system board. The reserve battery is attached to the system board with a piece of adhesive tape.
5. Remove any remnants of the adhesive tape from the system board.

Reserve Battery Removal

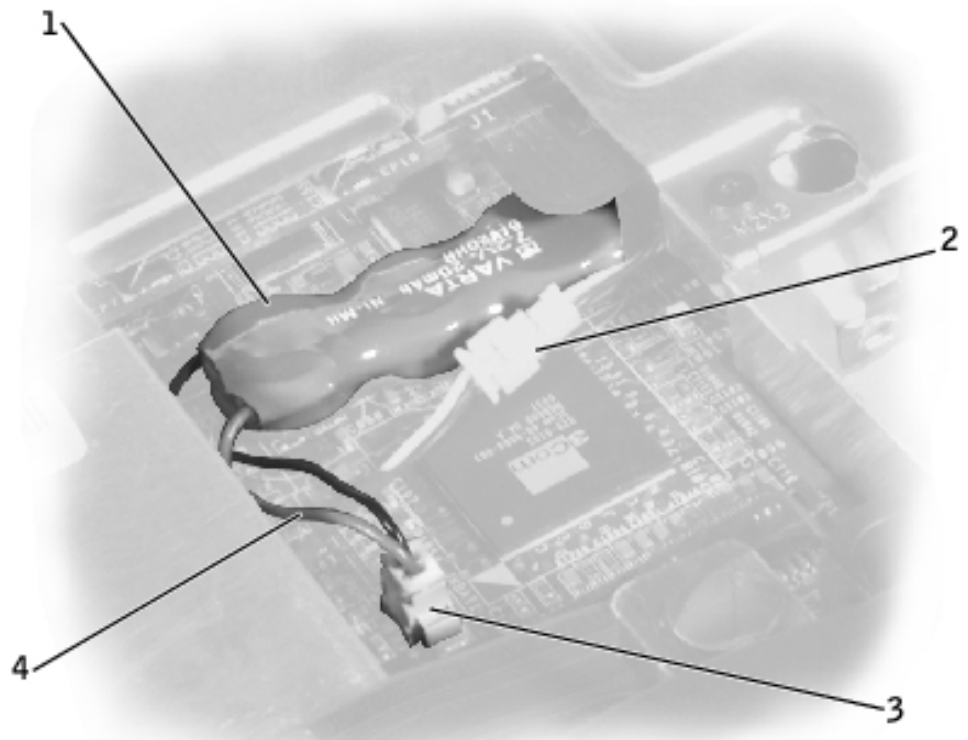

1	reserve battery
2	speaker connector
3	system board connector
4	reserve battery cable

Replacing the Reserve Battery

1. Connect the reserve battery cable to the system board connector.
2. Position the reserve battery above the speaker connector on the system board.
3. Update the BIOS using a flash BIOS update program floppy disk or CD. For instructions on how to flash the BIOS, see "[Flashing the BIOS](#)."

[Back to Contents Page](#)

[Back to Contents Page](#)

Flashing the BIOS

Dell™ Latitude™ C610/C510 Service Manual

 [Flashing the BIOS](#)

Flashing the BIOS

To update the basic input/output system (BIOS):

1. Make sure that the AC adapter is plugged in and that the main battery is installed properly.
2. Turn on the computer. The following error message appears:

```
System hardware failures: #0010
```

```
Strike the F1 key to shutdown
```

3. Instead of pressing <F1>, insert the flash BIOS update floppy disk or CD into the appropriate drive and press <F6>, and then press <F4>. The computer displays the following message on the screen:

```
Failure override
```

```
Processor update failure. Reload current BIOS
```

```
Strike the F1 key to continue, F2 to run the setup utility.
```

4. Press <F1>. The computer continues to boot and updates the new BIOS.
 5. Press <F2> to enter the system setup program and reset the boot sequence with the appropriate drive, if required.
 6. Press <ESC> to exit the system setup program.
 7. Remove the flash BIOS update floppy disk or CD from the drive and restart the computer.
-

[Back to Contents Page](#)



[Back to Contents Page](#)

Speaker Assemblies

Dell™ Latitude™ C610/C510 Service Manual

- [Removing the Speaker Assemblies](#)
 - [Replacing the Speaker Assemblies](#)
-

Removing the Speaker Assemblies

-  **NOTICE:** Disconnect the computer and any attached devices from electrical outlets, and remove any installed batteries.
-  **NOTICE:** To avoid ESD, ground yourself by using a wrist grounding strap or by touching an unpainted metal surface on the computer.
-  **NOTICE:** Read "[Preparing to Work Inside the Computer](#)" before performing the following procedure.

The speakers are located on the front left and right sides of the bottom case. Each speaker assembly is marked with a left or right label. Take note of the speaker and antenna wire routing so that you can replace them properly under their routing clips.

Routing the Left Speaker Cable

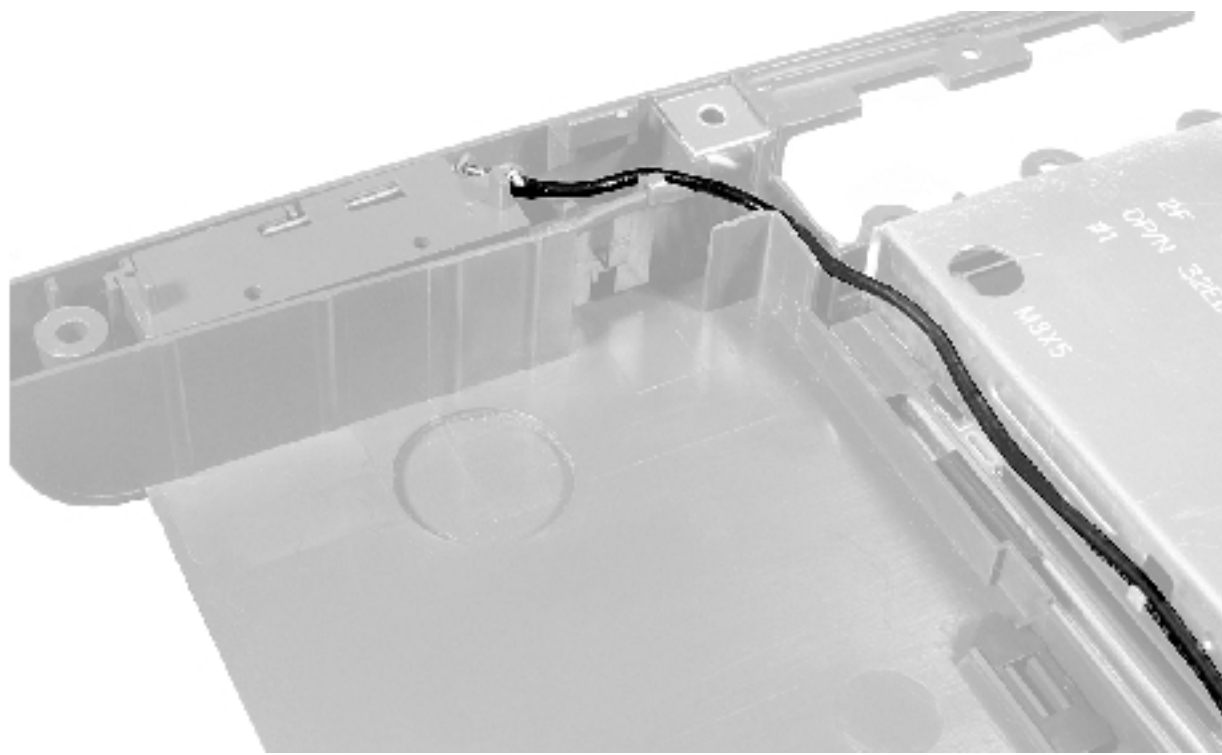

Speaker Orientation

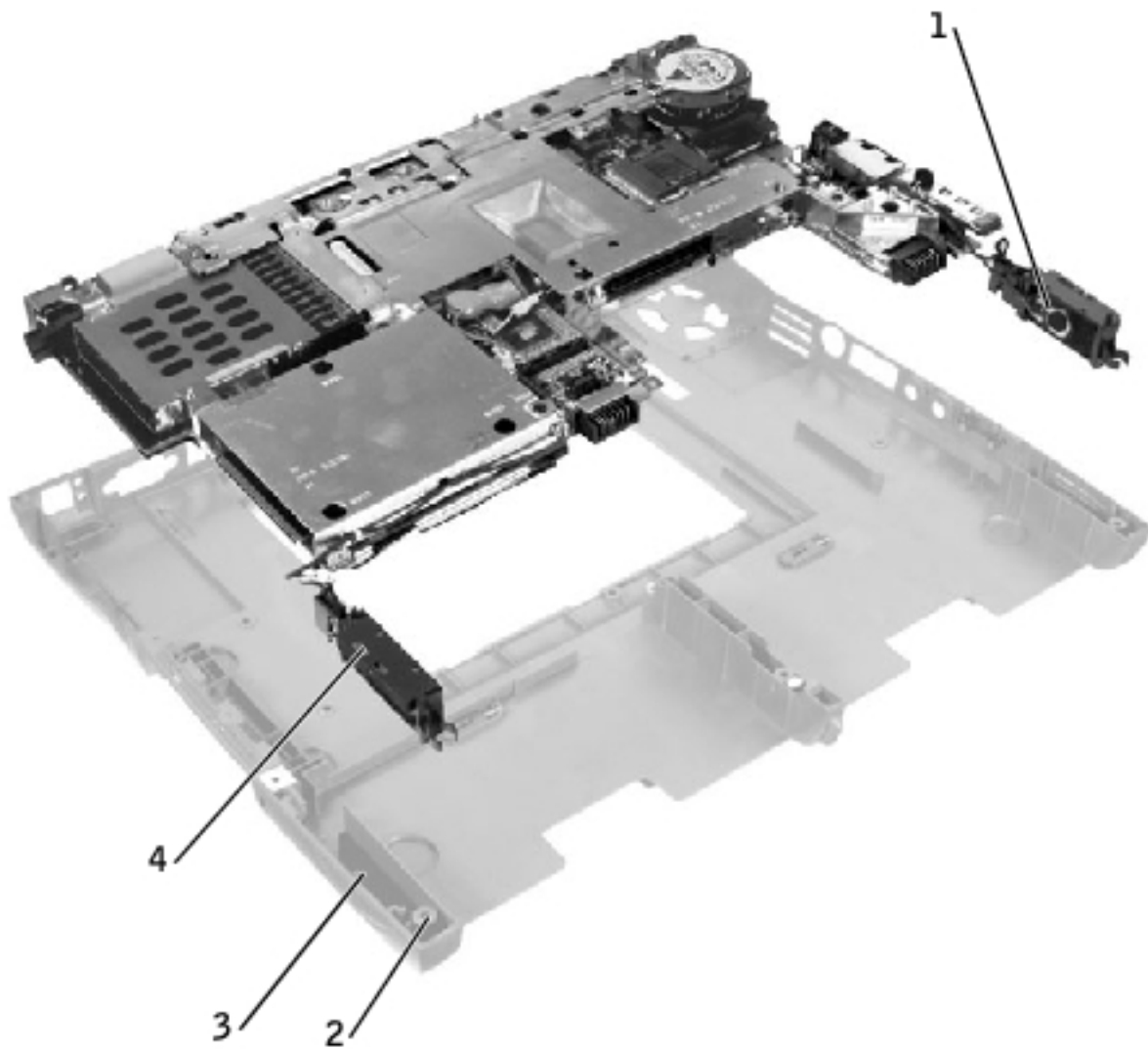

1	right speaker
2	palm-rest screw post
3	bottom case holders (2)
4	left speaker

Speaker Assemblies

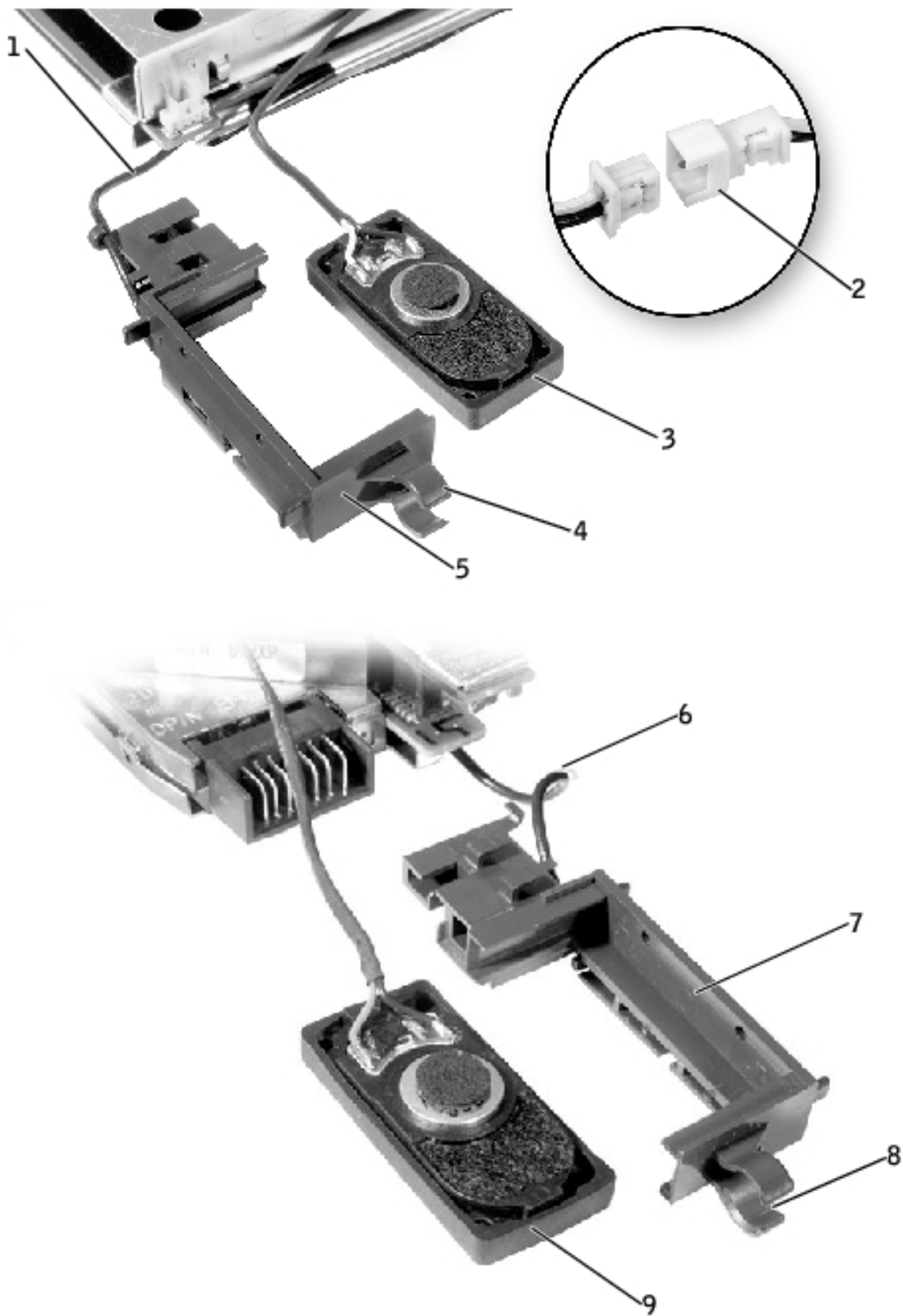



1 antenna cable

6 antenna cable

2	in-line connector	7	right speaker holder
3	left speaker	8	mounting ring
4	mounting ring	9	right speaker
5	left speaker holder		

1. Remove the [hard drive](#).
2. Remove the [keyboard](#).
3. Remove the [display assembly](#).
4. Remove the [palm rest](#).
5. Disconnect the speaker interface cable connectors.

 **NOTICE:** Do not pull the antenna wire when removing the speaker (see "[Speaker Orientation](#)").

 **NOTICE:** Handle the speaker assemblies and speakers with care to avoid damaging the speaker cones.

6. Remove the speaker assemblies by pulling them straight up and out of the bottom case.

 **NOTE:** The left speaker has an in-line connector, and its antenna cable is longer than the antenna cable of the right speaker.

Replacing the Speaker Assemblies

1. Place the mounting ring over the front palm-rest screw post.

 **NOTICE:** Make sure the speaker wires are under their routing clips. Route the left speaker wire properly between the battery bay and hard drive area.

2. Slide the speaker assembly down in to the bottom case.

 **NOTE:** Speakers face out in the bottom case holders.

[Back to Contents Page](#)

[Back to Contents Page](#)

System Board



Dell™ Latitude™ C610/C510 Service Manual

[Removing the System Board](#)

[Replacing the System Board](#)

Removing the System Board

The system board's BIOS chip contains the service tag sequence, which is also visible on a barcode label on the bottom of the computer. The replacement kit for the system board includes a CD that provides a utility for transferring the service tag sequence to the replacement system board.

-  **NOTICE:** Disconnect the computer and any attached devices from electrical outlets, and remove any installed batteries.
-  **NOTICE:** To avoid ESD, ground yourself by using a wrist grounding strap or by touching an unpainted metal surface on the computer.
-  **NOTICE:** Read "[Preparing to Work Inside the Computer](#)" before performing the following procedure.

1. Remove the [hard drive](#).
2. Remove the [keyboard](#).
3. Remove the [display assembly](#).
4. Remove the [palm rest](#).
5. Remove the [microprocessor thermal cooling assembly](#).
6. Remove the [microprocessor](#).
7. Remove the [modem](#), [memory modules](#), and [Mini PCI card](#).
8. Turn the computer over, and remove the six M2.5 x 5-mm screws labeled "circle B" that secure the system board to the bottom case.
9. Remove the three M2.5 x 5-mm screws labeled "circle B" that secure the fan guard to the bottom case.

System Board Screw Removal

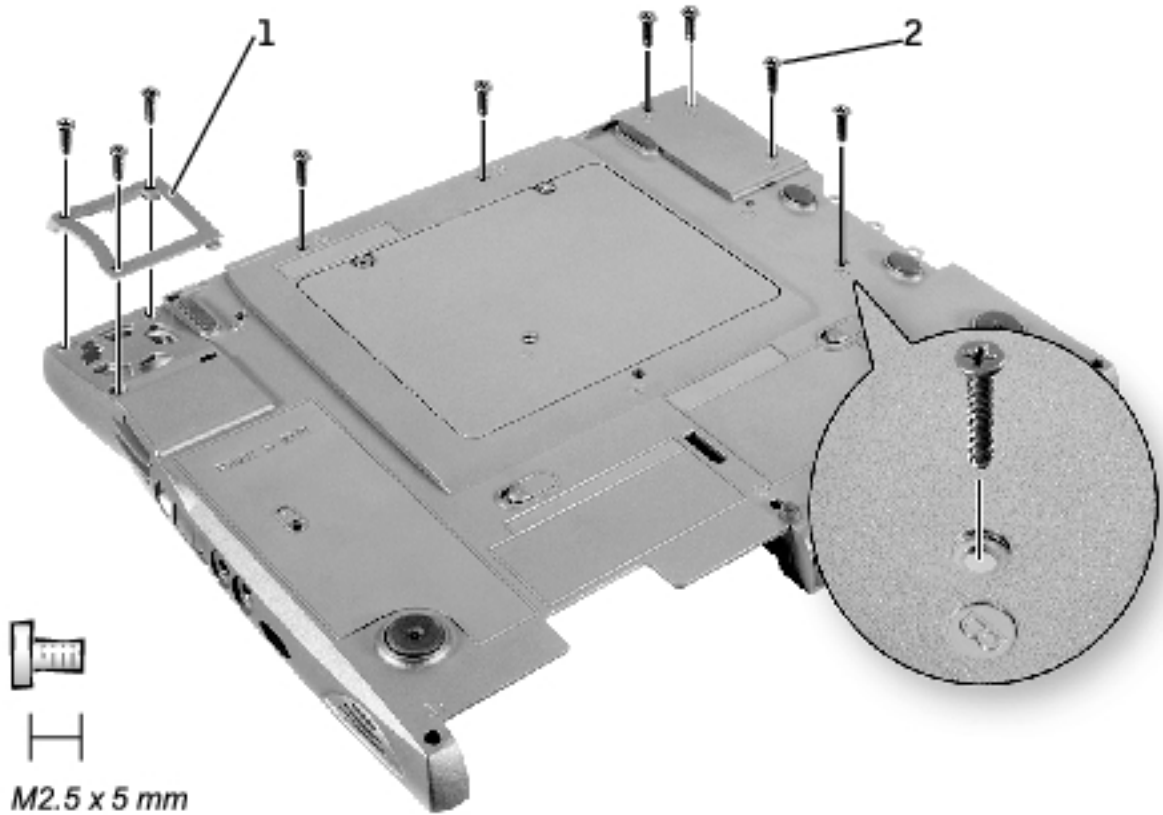

1	fan guard
2	M2.5 x 5-mm screws (9)

10. Turn the computer over and remove the M2.5 x 5-mm screw, which is labeled "circle B" with an arrow on the front center of the system board by the battery connector (see "[System Board Removal](#)").

System Board Removal

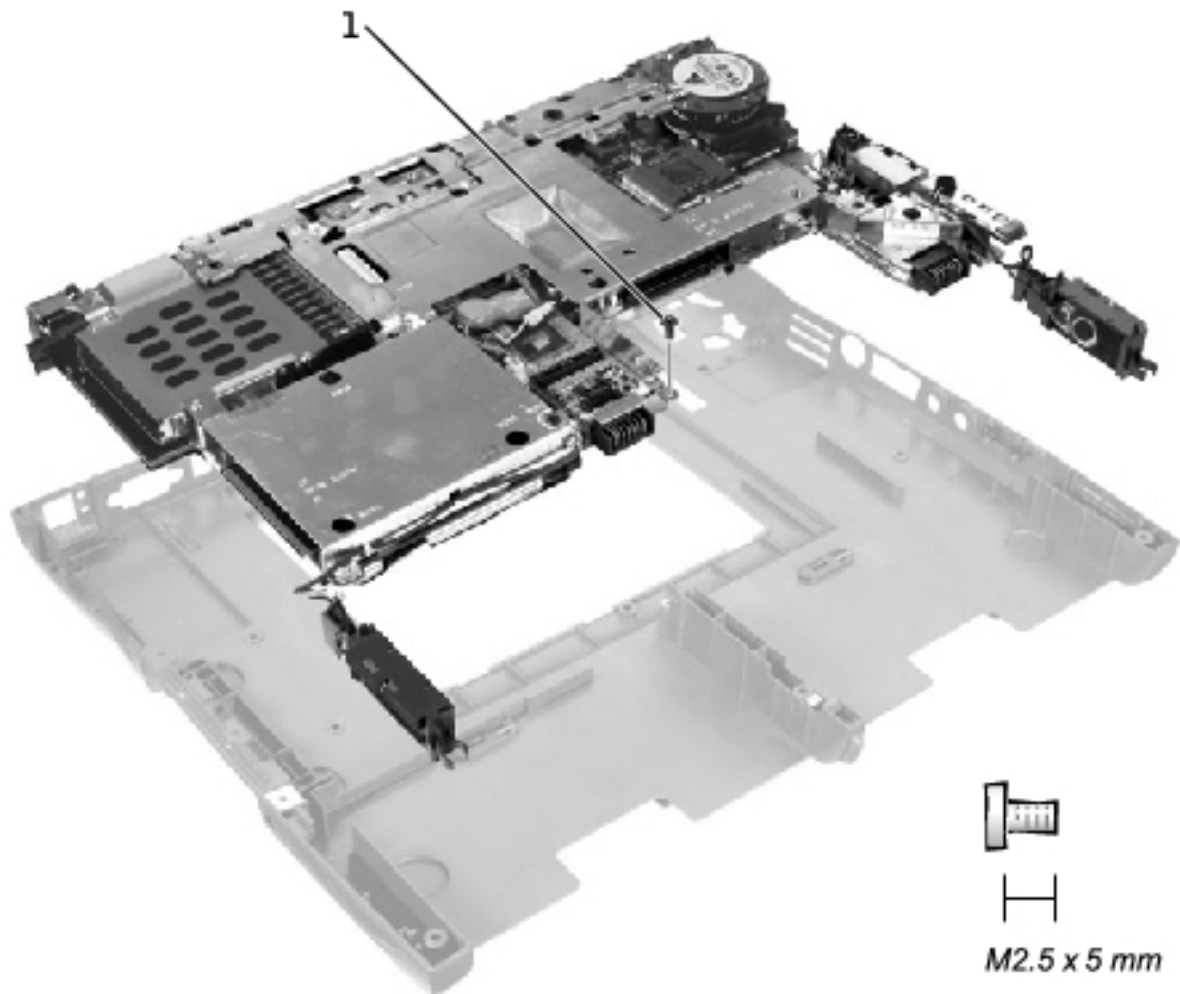

1	M2.5 x. 5-mm screw (1)
---	------------------------

11. Remove the [speakers](#) from the bottom case.
12. Pull the right side of the bottom case, next to the external headphone and microphone connectors, away from the system board as you simultaneously lift the front of the system board out and away from the bottom case.

Replacing the System Board

1. Install the [microprocessor](#) on the replacement system board.
2. Connect the right and left [speakers](#) to the replacement system board.
3. Install the replacement system board.
 - a. Insert the external microphone and headphone connectors through the bottom case.

- b. Replace the six M2.5 x 5-mm screws, starting on the right side of the bottom case (see "[System Board Screw Removal](#)").
 - c. Replace the fan guard, inserting the tab into the bottom case, and replace the three M2.5 x 5-mm screws (see "[System Board Screw Removal](#)"). Replacing the screw opposite the tab first makes it easier to insert and replace the other two screws.
4. Replace the modem, the speaker assemblies, and the microprocessor thermal cooling assembly that you removed from the old system board.



NOTE: Be sure to route cables so that they will not be crimped or pinched when the complete assembly is put back together.

5. Replace the palm rest, the keyboard, the display assembly, and the hard drive.
6. Replace the module bay devices and any PC Cards or plastic blanks in the PC Card slot.
7. Insert the floppy disk or CD that accompanied the replacement system board into the appropriate drive, and turn on the computer. Follow the instructions on the screen.



NOTE: After replacing the system board, be sure to enter the computer service tag sequence into the BIOS of the replacement system board.

[Back to Contents Page](#)



[Back to Contents Page](#)

Battery and Module Bay Latches

Dell™ Latitude™ C610/C510 Service Manual

- [Removing the Battery and Module Bay Latches](#)
 - [Replacing the Battery and Module Bay Latches](#)
-

Removing the Battery and Module Bay Latches

-  **NOTICE:** Disconnect the computer and any attached devices from electrical outlets, and remove any installed batteries.
-  **NOTICE:** To avoid ESD, ground yourself by using a wrist grounding strap or by touching an unpainted metal surface on the computer.
-  **NOTICE:** Read "[Preparing to Work Inside the Computer](#)" before performing the following procedure.

1. Remove the [hard drive](#).
2. Remove the [keyboard](#).
3. Remove the [display assembly](#).
4. Remove the [palm rest](#).
5. Remove the [system board](#).
6. Remove the latch button by using a plastic scribe to push on the snap tabs until the latch button is released from the bottom case.

To prevent the latch assembly from coming loose, apply pressure to the latch and spring while removing the latch button. If the latch assembly *does* come loose from the case:

- a. Slide the spring onto the slider on the latch, and reinstall the latch into the holding features on the inside of the bottom case.
- b. Ensure that the slider is inserted into the hole, that the side of the latch with the two bumps is facing the back of the case, and that the side with the wear rib is facing the front of the case.

NOTE: The latch will not function properly if the slider is oriented incorrectly.

Battery and Module Bay Latches

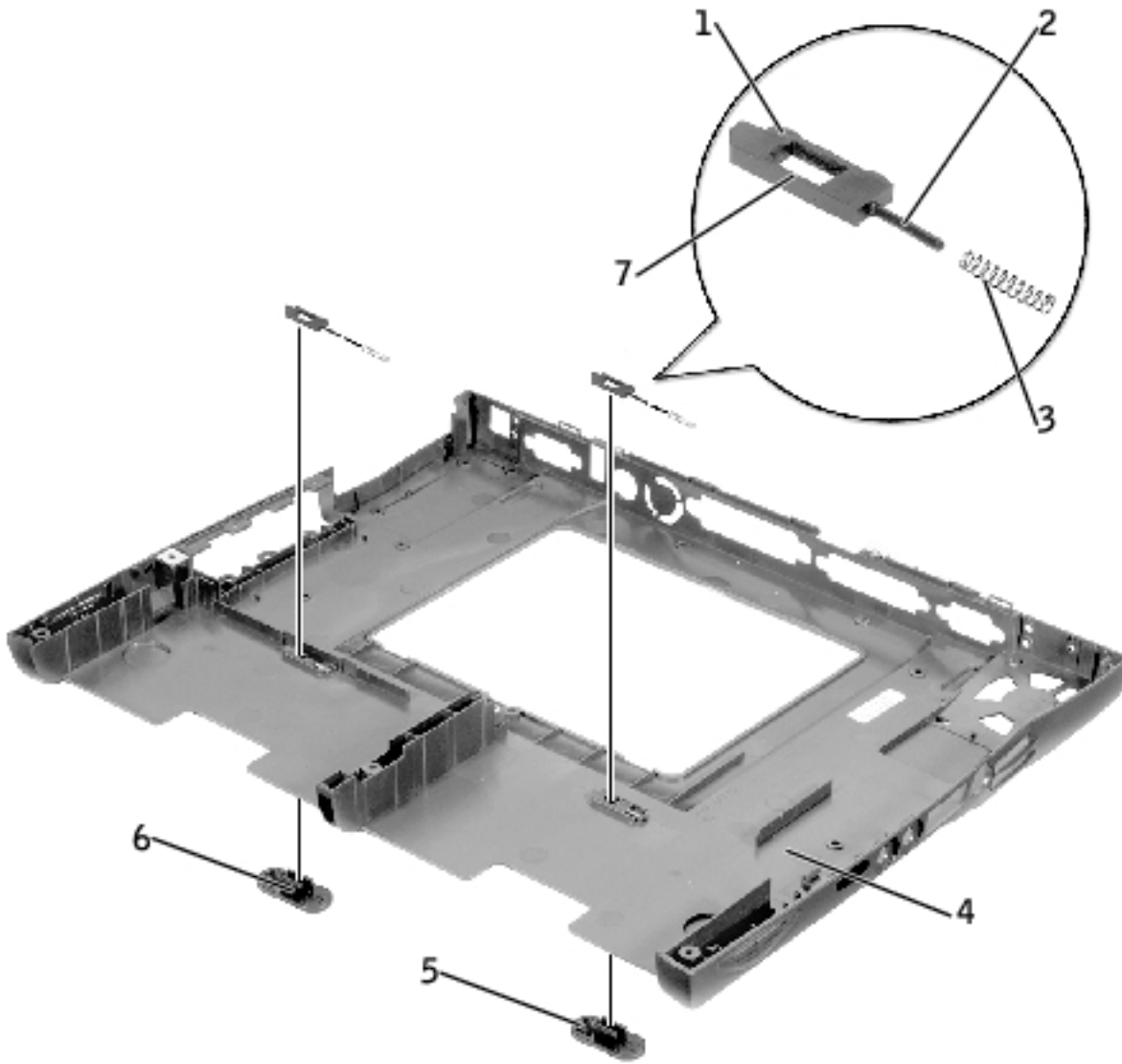

1	bumps (2 per latch)	5	latch buttons (2)
2	slider	6	snap tabs (2 per latch button)
3	spring	7	wear rib
4	bottom case		

Replacing the Battery and Module Bay Latches

1. Snap in the new latch button from behind the bottom case, making certain that the snap tabs are fully engaged in the latch.

To prevent the latch assembly from coming loose, apply pressure to the latch and spring while replacing the latch button.

2. Ensure that the newly installed latch moves smoothly and freely when pushed and released.
-

[Back to Contents Page](#)

[Back to Contents Page](#)

Pin Assignments for I/O Connectors

Dell™ Latitude™ C610/C510 Service Manual

USB Connector

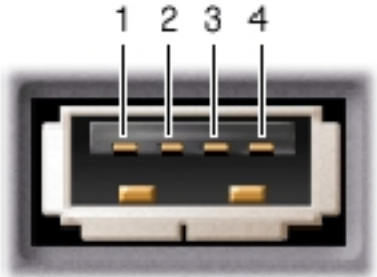

Pin	Signal
1	VCC
2	-Data
3	+Data
4	Ground

Serial Connector



1 2 3 4 5
6 7 8 9

Pin	Signal	Pin	Signal
1	DCD	6	DSR
2	RXDA	7	RTS
3	TXDA	8	CTS
4	DTR	9	RI
5	GND		

Parallel Connector



13 12 11 10 9 8 7 6 5 4 3 2 1
25 24 23 22 21 20 19 18 17 16 15 14

Pin	Signal	Pin	Signal
1	STRB#/5V	11	BUSY/MTR#

2	PD0/INDEX#	12	PE/WDATA#
3	PD1/TRK0#	13	SLCT/WGATE#
4	PD2/WP#	14	AFDF#
5	PD3/RDATA#	15	ERROR#HDSEL#
6	PD4/DSKCHG#	16	INIT#/DIR#
7	PD5F	17	SLCT_IN#STEP#
8	PD6F	18-23	GND
9	PD7F	24	DFDD/LPT#
10	ACK#/DRV#	25	GND

Video Connector



Pin	Signal	Pin	Signal
1	RED	9	CRT_VCC
2	GREEN	10	GND
3	BLUE	11	MSEN#
4	NC	12	DAT_DDC2
5	GND	13	HSYNC
6	GND	14	VSYNC
7	GND	15	CLK_DDC2
8	GND		

PS/2 Connector

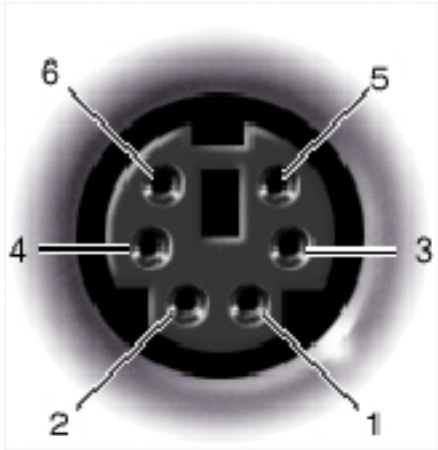

Pin	Signal
1	DAT_KBD
2	DAT_SM1
3	GND
4	PS2VCC
5	CLK_KBD
6	CLK_SM1

S-Video TV-Out Connector

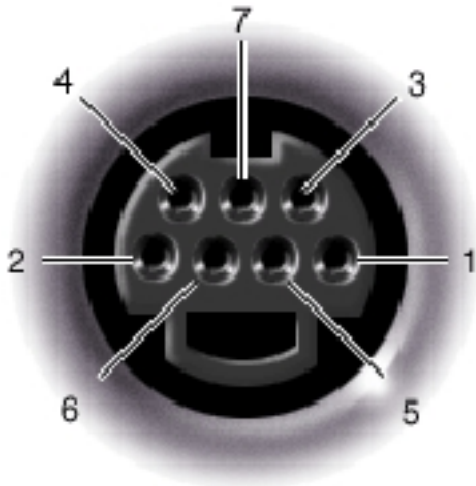

S-Video	
Pin	Signal
1	GND
2	GND
3	DLUMA-L
4	DCRMA-L

Composite Video	
Pin	Signal
5	NC
6	DCMPS-L
7	GND

Docking Connector

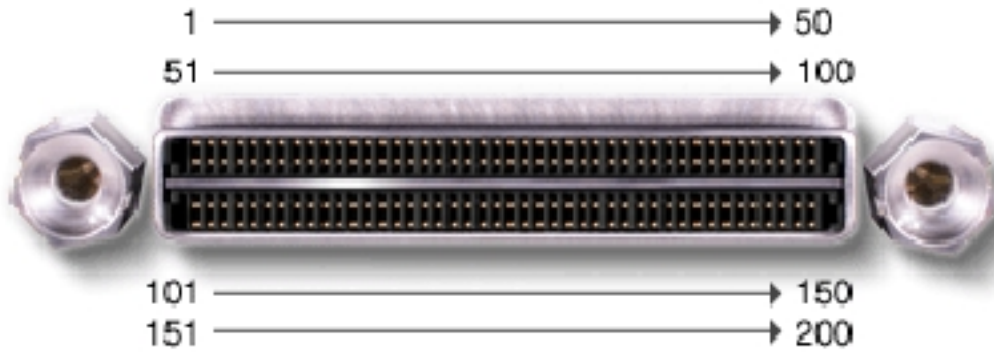

Pin	Signal	Pin	Signal
1	STRB#/5V	101	VGA_GRN
2	PDO	102	GND

3	PD1	103	VGA_RED
4	PD2	104	GND
5	PD3	105	VGA_BLU
6	PD4	106	DOCK_SD/MODE
7	PD5	107	D_IRTX
8	PD6	108	D_IRRX
9	PD7	109	GND
10	GND	110	SPIRQB#
11	DOCK_SPKR	111	SPIRQC#
12	DOCK_MIC	112	DAT_DDC2
13	DOCK_LINE	113	CLK_DDC2
14	DOCK_CDROM	114	SPAR
15	GND	115	SPME#
16	M_SEN#	116	GND
17	POWER_SW#	117	SSERR#
18	QPCIEN#	118	SPERR#
19	S1.6M_EN#	119	SLOCK#
20	DFDD/LPT#	120	SSTOP#
21	GND	121	GND
22	NC	122	SDEVSEL#
23	NC	123	STRDY#
24	D_ATCTLED	124	SIRDY#
25	D_PWRLED	125	SFRAME#
26	DOCK_PWR_SRC	126	SCLKRUN#
27	DOCK_PWR_SRC	127	GND
28	DOCK_PWR_SRC	128	SGNTA#
29	GND	129	SREQA#
30	+5VDOCK	130	SGNT0#
31	+5VDOCK	131	SREQ0#
32	+5VDOCK	132	SPCIRST#
33	+5VDOCK	133	SH1SEL#

34	+5VDOCK	134	GND
35	GND	135	SWRPRT#
36	DOCK_PWR_SRC	136	SDSKCHG#/DRQ
37	DOCK_PWR_SRC	137	SDIR#
38	DOCK_PWR_SRC	138	STRK0#
39	DOCK_PWR_SRC	139	SSTEP#
40	GND	140	SDRV1#
41	DOCK_+DC_IN	141	GND
42	DOCK_+DC_IN	142	SMRT1#
43	DOCK_+DC_IN	143	SWRDATA#
44	DOCK_+DC_IN	144	SWGATE#
45	DOCK_+DC_IN	145	SRDATA#
46	DOCK_+DC_IN	146	SINDEX#
47	DOCK_+DC_IN	147	GND
48	DOCK_+DC_IN	148	NC
49	GND	149	+5VALW
50	LOW_PWR	150	NC
51	HSYNC	151	GND
52	VSYNC	152	CLK_SPCI
53	GND	153	GND
54	DOCKED	154	SAD0
55	USB_VD1+	155	SAD1
56	USB_VD1-	156	SAD2
57	GND	157	SAD3
58	USB_VD2+	158	SAD4
59	USB_VD2-	159	SAD5
60	DOCKOCI#	160	SAD6
61	RUN_ON#	161	GND
62	GND	162	SAD7
63	NC	163	SAD8
64	DOCK_SCLK	164	SC/BE0#

65	DOCK_LRCK	165	SAD9
66	DOCK_MCLK	166	SAD10
67	GND	167	SAD11
68	+12V	168	SAD12
69	AFD#	169	GND
70	ERROR#	170	SAD13
71	ACK#	171	SAD14
72	GND	172	SAD15
73	INIT#	173	SAD16
74	SLCT_IN#	174	SC/BE1#
75	BUSY	175	CD/BE2#
76	PE	176	GND
77	SLCT	177	SAD17
78	GND	178	SAD18
79	DAT_SMB	179	SAD19
80	DCLK_SMB	180	SAD20
81	SMB_INIT#	181	SAD21
82	GND	182	GND
83	DAT_DOCKSM1	183	SAD22
84	CLK_DOCKSM1	184	SAD23
85	DAT_DOCKKBD	185	SAD24
86	CLK_DOCKKBD	186	SC/BE3#
87	GND	187	SAD25
88	RI0	188	GND
89	CTS0	189	SAD26
90	RTS0	190	SAD27
91	DSR0	191	SAD28
92	GND	192	SAD29
93	DTR0	193	SAD30
94	TXD0#	194	SAD31
95	RXD0#	195	GND

96	DCD0	196	NC
97	NC	197	NC
98	+5VSUS	198	NC
99	NC	199	NC
100	NC	200	GND

[Back to Contents Page](#)