

Thank you for purchasing this Factory Service Manual CD/DVD from [servicemanuals4u.com](http://servicemanuals4u.com).

Please check out our eBay auctions for more great deals on Factory Service Manuals:

[servicemanuals4u](http://servicemanuals4u.com)

# Dell™ Inspiron™ 8500/8600 Service Manual

[Before You Begin](#)

[System Components](#)

[Memory Module, Mini PCI Card, Modem, and Modules](#)

[Color Insert Cover](#)

[Hard Drive](#)

[Bluetooth™ Card](#)

[Fan](#)

[Docking Doors](#)

[Keyboard](#)

[Display Assembly](#)

[Video Card](#)

[Microprocessor Thermal-Cooling Assembly](#)

[Palm Rest](#)

[Microprocessor Module](#)

[Flashing the BIOS](#)

[Reserve Battery](#)

[System Board](#)

[Speakers](#)

[Base Latch](#)

[Pin Assignments for I/O Connectors](#)

---

## Notes, Notices, and Cautions



**NOTE:** A NOTE indicates important information that helps you make better use of your computer.



**NOTICE:** A NOTICE indicates either potential damage to hardware or loss of data and tells you how to avoid the problem.



**CAUTION:** A CAUTION indicates a potential for property damage, personal injury, or death.

---

Information in this document is subject to change without notice.

© 2003 Dell Inc. All rights reserved.

Reproduction in any manner whatsoever without the written permission of Dell Inc. is strictly forbidden.

Trademarks used in this text: *Dell*, the *DELL* logo, and *Inspiron* are trademarks of Dell Inc.; *Intel* is a registered trademark of Intel Corporation; *Microsoft* and *Windows* are registered trademarks of Microsoft Corporation; *Bluetooth* is a trademark owned by Bluetooth SIG, Inc. and is used by Dell Inc. under license.

Other trademarks and trade names may be used in this document to refer to either the entities claiming the marks and names or their products. Dell Inc. disclaims any proprietary interest in trademarks and trade names other than its own.

**Model PP02X**

**August 2003 Rev. A02**

[Back to Contents Page](#)

# Before You Begin

## Dell™ Inspiron™ 8500/8600 Service Manual

- [Preparing to Work Inside the Computer](#)
  - [Recommended Tools](#)
  - [Computer Orientation](#)
  - [Screw Identification](#)
- 

## Preparing to Work Inside the Computer

 **CAUTION:** Only a certified service technician should perform repairs on your computer. Damage due to servicing that is not authorized by Dell is not covered by your warranty. Read and follow applicable instructions in the safety instructions in the *Owner's Manual* that came with the computer.

 **CAUTION:** To prevent static damage to components inside your computer, discharge static electricity from your body before you touch any of your computer's electronic components. You can do so by touching an unpainted metal surface.

 **CAUTION:** Handle components and cards with care. Do not touch the components or contacts on a card. Hold a card by its edges or by its metal mounting bracket. Hold a component such as a microprocessor by its edges, not by its pins.

 **NOTICE:** To avoid damaging the computer, perform the following steps before you begin working inside the computer.

1. Ensure that the work surface is flat and clean to prevent scratching the computer cover.
2. Save any work in progress and exit all open programs.
3. Turn off the computer and all attached devices.

 **NOTE:** Ensure that the computer is off and not in a power management mode. If you cannot shut down the computer using the computer operating system, press and hold the power button for 4 seconds.

4. If the computer is connected to a docking station, undock it.
5. Disconnect the computer from the electrical outlet.

6. To avoid possible damage to the system board, wait 10 to 20 seconds and then disconnect any attached devices.
7. Disconnect all other external cables from the computer.
8. Remove any installed PC Cards from the PC Card slot.
9. Close the display and turn the computer upside down on a flat work surface.

 **NOTICE:** To avoid damaging the system board, you must remove the main battery before you service the computer.

10. Slide and hold the battery-bay latch release on the bottom of the computer, and then remove the battery from the bay.



11. Remove any installed [memory modules](#), [Mini PCI cards](#), and [modules](#), including a second battery if one is installed.
12. Remove the [hard drive](#).

---

## Recommended Tools

The procedures in this manual require the following tools:

- #1 Phillips screwdriver
- ¼-inch flat-blade screwdriver

- Small plastic scribe
- Flash BIOS update program floppy disk or CD

---

## Computer Orientation

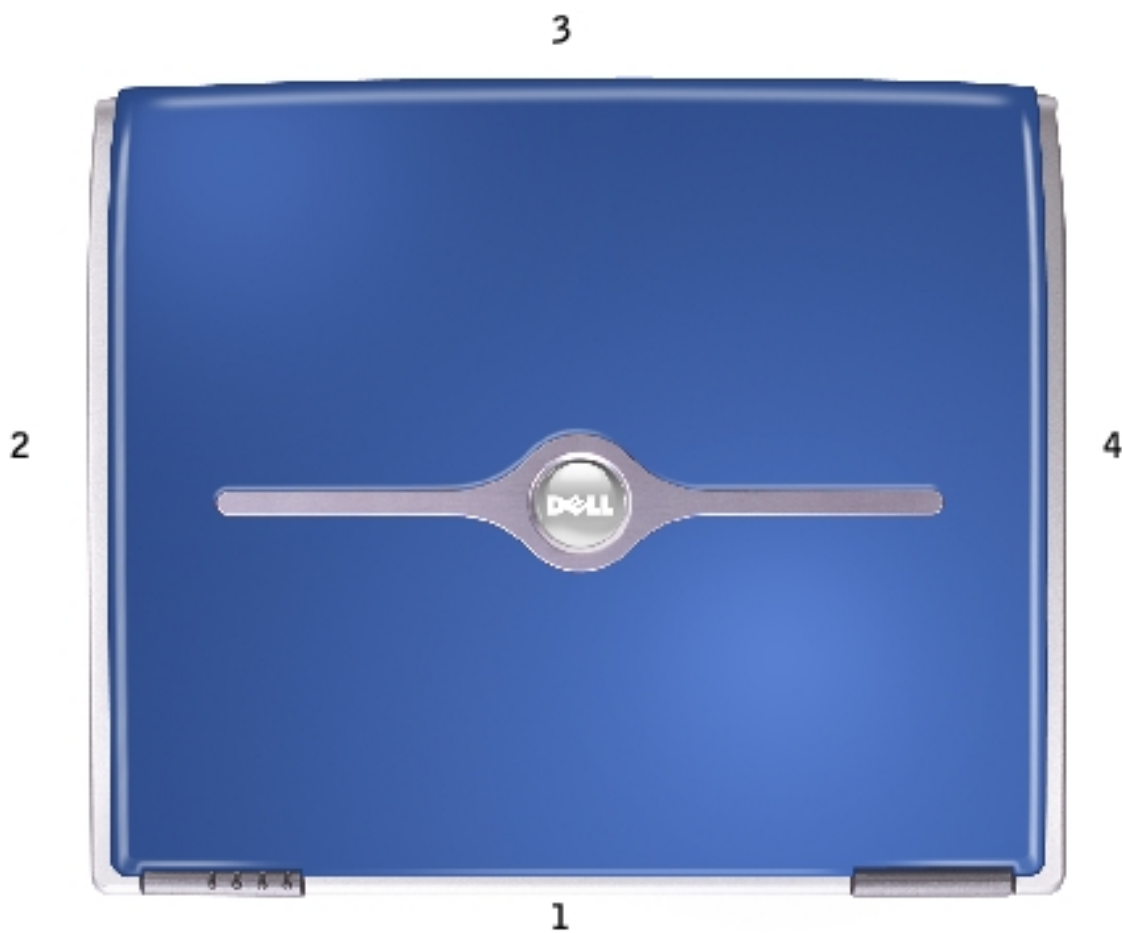

1	back
2	right
3	front
4	left

---

## Screw Identification

When you are removing and replacing components, photocopy "[Screw Identification](#)" as a tool to lay out and keep track of the screws. The placemat provides the number of screws and their sizes.



*M2 x 3 mm    M2 x 3 mm    M2.5 x 3 mm    M2.5 x 4 mm    M2.5 x 4.5 mm*



*M2.5 x 6 mm    M2.5 x 6 mm    M2.5 x 12 mm    M3 x 3 mm*

Optional Module:

(1 each)

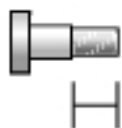

*M2 x 3 mm*

Modem:

(1 each)



*M2 x 3 mm*

Hard Drive:

(1 each)



*M3 x 3 mm*

Fan:

(2 each)

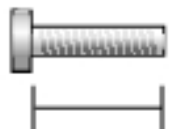

*M2.5 x 12 mm*

Keyboard:

(2 each)

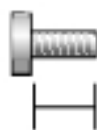

*M2.5 x 6 mm*

Display Assembly:

(2 each)

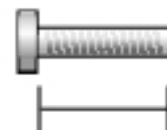

*M2.5 x 12 mm*

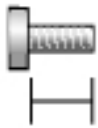

***M2.5 x 6 mm***

**Display Bezel:**

(shoulder screw covers, 2 each)

(display bumpers, 6 each)

(2 each)

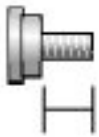

***M2.5 x 4.5 mm***

(6 each)

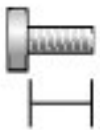

***M2.5 x 6 mm***

**Display Panel:**

(9 each)



***M2 x 3 mm***

**Display Latch:**

(2 each)

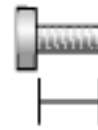

***M2.5 x 6 mm***



Video Card

(4 each)

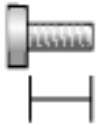

*M2.5 x 6 mm*

Palm Rest:

(2 each)

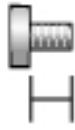

*M2.5 x 4 mm*

Speakers:

(1 each)



*M2.5 x 3 mm*

(13 each)

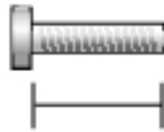

*M2.5 x 12 mm*

System Board:

(3 each)

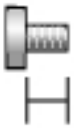

*M2.5 x 4 mm*

(2 each)

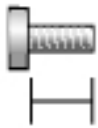

*M2.5 x 6 mm*

(1 each)

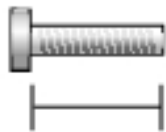

*M2.5 x 12 mm*

[Back to Contents Page](#)

[Back to Contents Page](#)

# System Components

## Dell™ Inspiron™ 8500/8600 Service Manual

 **NOTICE:** Only a certified service technician should perform repairs on your computer. Damage due to servicing that is not authorized by Dell is not covered by your warranty.

 **NOTICE:** Unless otherwise noted, each procedure in this document assumes that a part can be replaced by performing the removal procedure in reverse order.

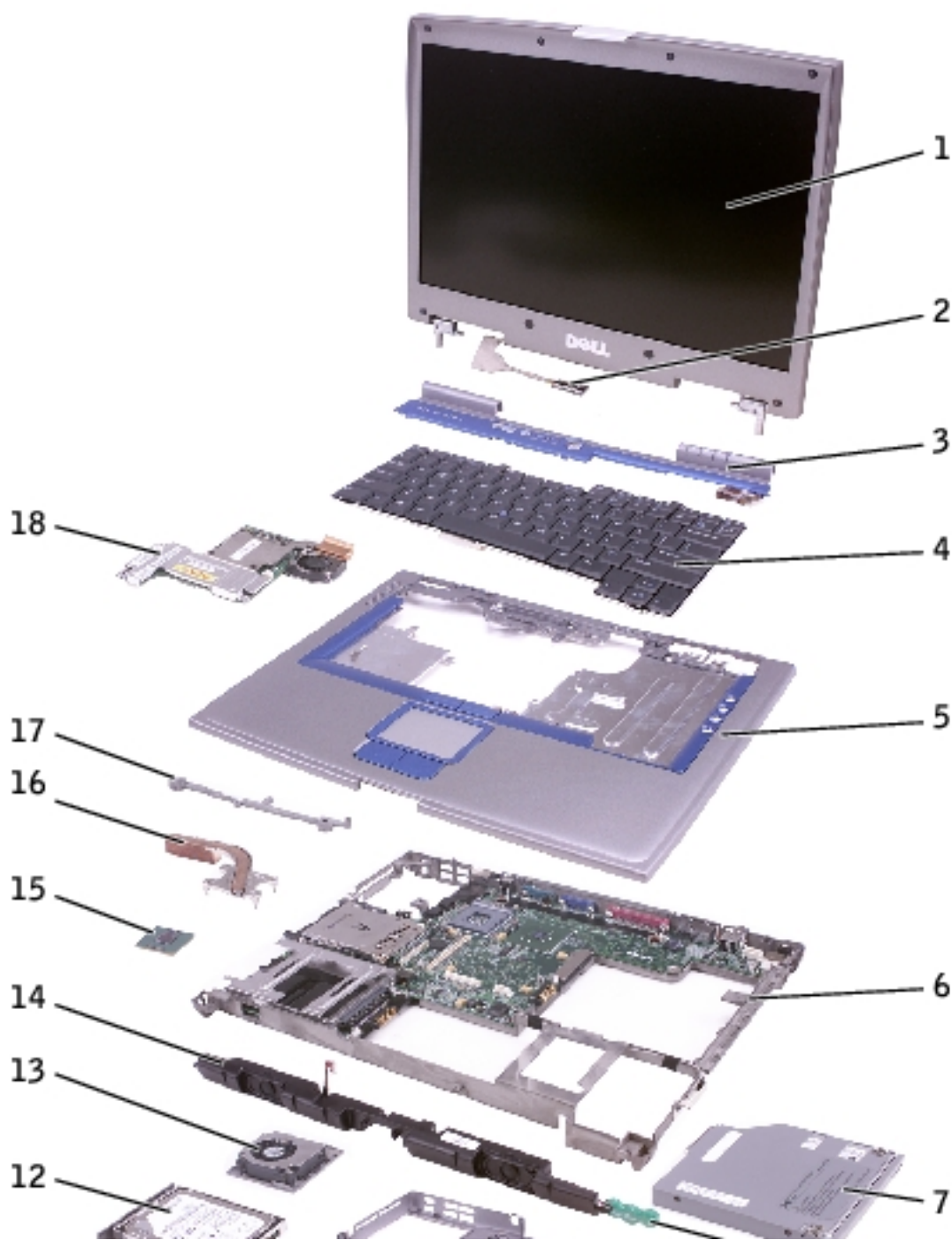

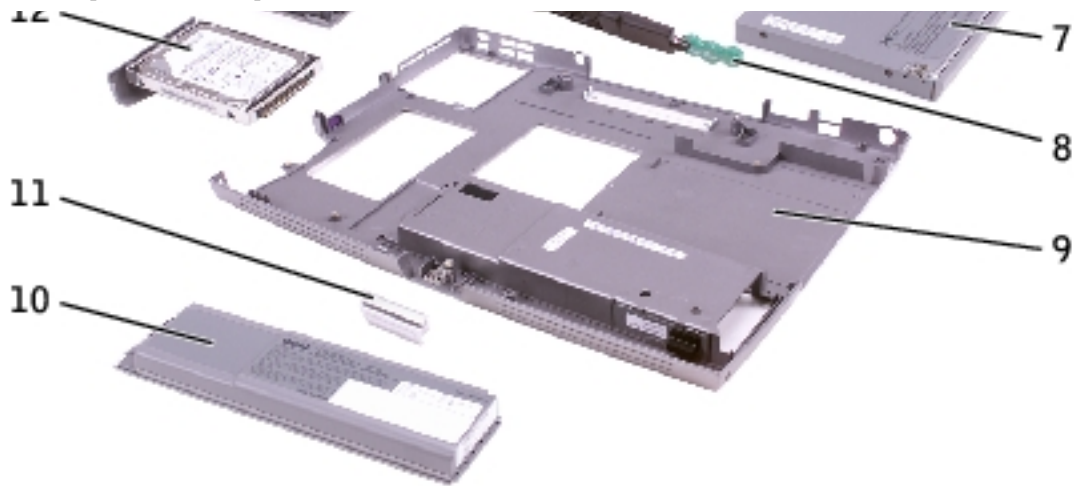

1	display assembly	10	battery
2	display cable	11	release latch
3	center control cover	12	hard drive
4	keyboard	13	fan
5	palm rest	14	speakers
6	system board assembly	15	microprocessor
7	optical drive	16	thermal cooling assembly
8	reserve battery	17	system board support
9	computer base	18	video card

[Back to Contents Page](#)

[Back to Contents Page](#)

# Memory Module, Mini PCI Card, Modem, and Modules

Dell™ Inspiron™ 8500/8600 Service Manual

 [Memory Module](#)

 [Mini PCI Card](#)

 [Modem](#)

 [Modules](#)

---

## Memory Module



**CAUTION:** Before working inside your Dell™ computer, read the safety instructions in your *Owner's Manual*.



**CAUTION:** To prevent static damage to components inside your computer, discharge static electricity from your body before you touch any of your computer's electronic components. You can do so by touching an unpainted metal surface.



**NOTE:** Memory modules purchased from Dell are covered under your computer warranty.

1. Follow the instructions in "[Preparing to Work Inside the Computer](#)."
2. Turn the computer over, loosen the captive screw from the memory module cover, and lift the cover.

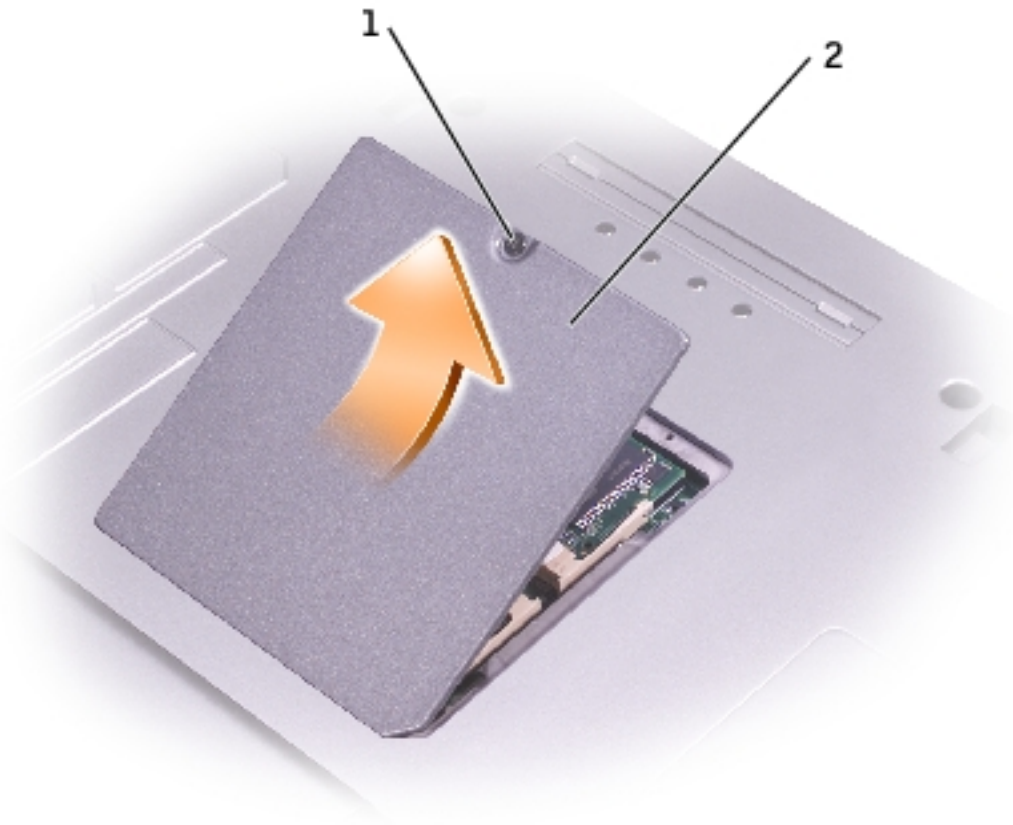

1	captive screw
2	memory module cover

**NOTICE:** To prevent damage to the memory module connector, do not use tools to spread the inner metal tabs that secure the memory module.

3. If you are replacing a memory module, remove the existing module.

**NOTICE:** Handle memory modules by their edges, and do not touch the components on a module.

a. Use your fingertips to carefully spread apart the securing clips on each end of the memory module connector until the module pops up.

b. Remove the module from the connector.

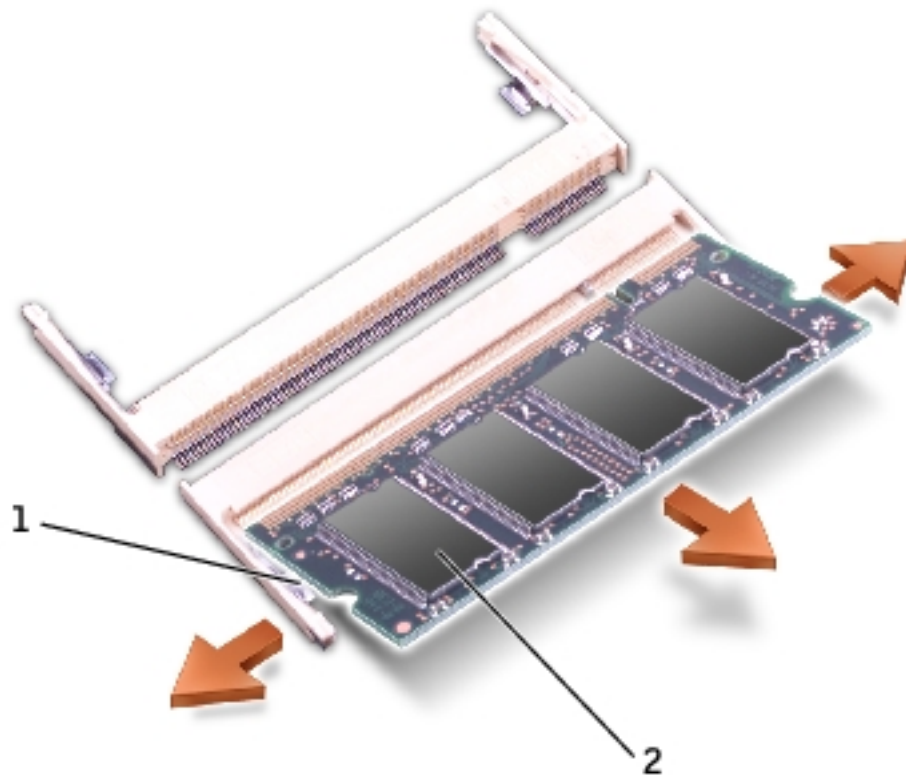

1	securing clips (2 per connector)
2	memory module

**NOTICE:** If you need to install memory modules in two connectors, install a memory module in the connector labeled "DIMMA (Slot 1)" before you install a module in the connector labeled "DIMMB."

4. Ground yourself and install the new memory module:
  - a. Align the notch in the module with the slot in the center of the connector.
  - b. Slide the edge of the module firmly into the connector, and rotate the module down until you feel a click. If you do not feel the click, remove the module and reinstall it.

**NOTE:** If the memory module is not installed properly, the computer does not boot. The Num Lock and Scroll Lock lights blink about ten times.

5. Replace the cover and screw.

**NOTICE:** If the memory module cover is difficult to close, remove the module and reinstall it. Forcing the cover to close may damage your computer.

6. Insert the battery into the battery bay, or connect the AC adapter to your computer and an electrical outlet.
7. Turn on the computer.

As the computer boots, it detects the additional memory and automatically updates the system configuration information.

---

## Mini PCI Card

If you ordered a Mini PCI card at the same time that you ordered your computer, Dell has already installed the card for you.



**CAUTION:** Before working inside your computer, read the safety instructions in your *Owner's Manual*.



**CAUTION:** To prevent static damage to components inside your computer, discharge static electricity from your body before you touch any of your computer's electronic components. You can do so by touching an unpainted metal surface.



**NOTICE:** Handle components and cards by their edges, and avoid touching pins and contacts.

1. Follow the instructions in "[Preparing to Work Inside the Computer](#)."
2. Turn the computer over, and loosen the captive screw on the Mini PCI card/modem cover.



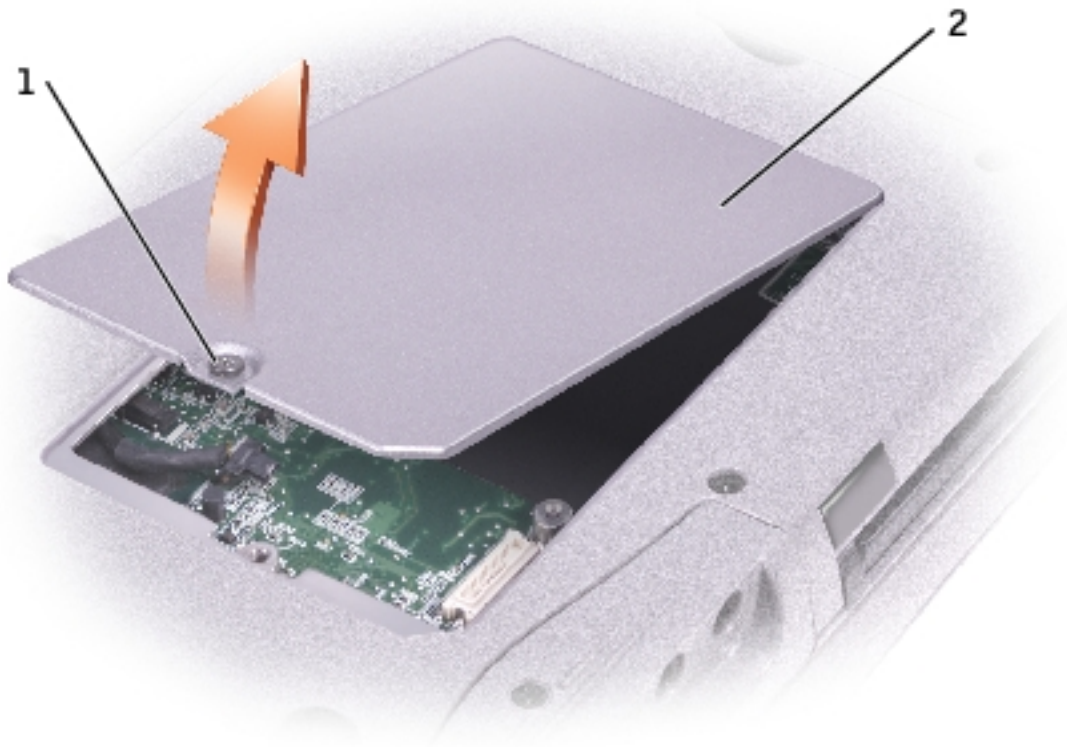

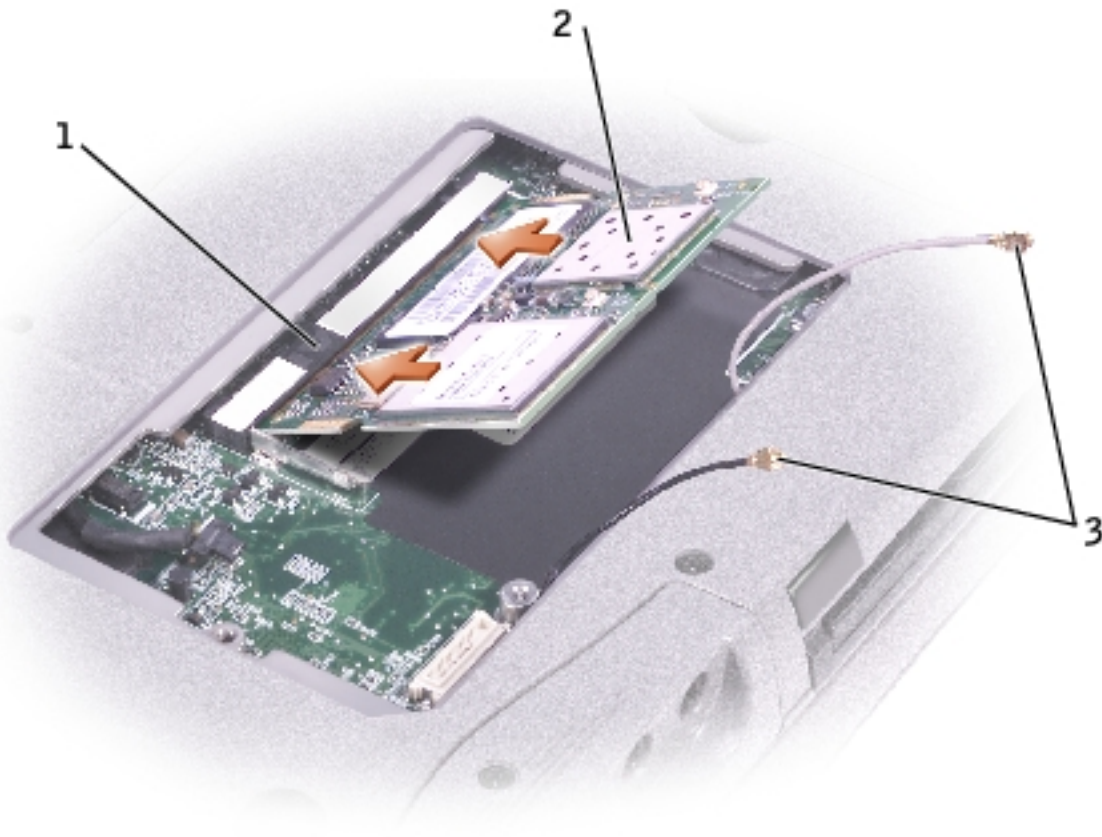

1	captive screw
2	Mini PCI card/modem cover

3. If a Mini PCI card is not already installed, go to [step 4](#). If you are replacing a Mini PCI card, remove the existing card:
  - a. Disconnect the Mini PCI card from any attached cables.
  - b. Release the Mini PCI card by spreading the metal securing tabs until the card pops up slightly.
  - c. Lift the Mini PCI card out of its connector.



1	Mini PCI card connector
2	Mini PCI card
3	antenna cables (2)

 **NOTICE:** To avoid damaging the Mini PCI card, never place cables on top of or under the card.

 **NOTICE:** The connectors are keyed to ensure correct insertion. If you feel resistance, check the connectors and realign the card.

4. Align the Mini PCI card with the connector at a 45-degree angle, and press the Mini PCI card firmly into the connector, and press down until you feel a click.
5. Connect the antenna cables to the Mini PCI.

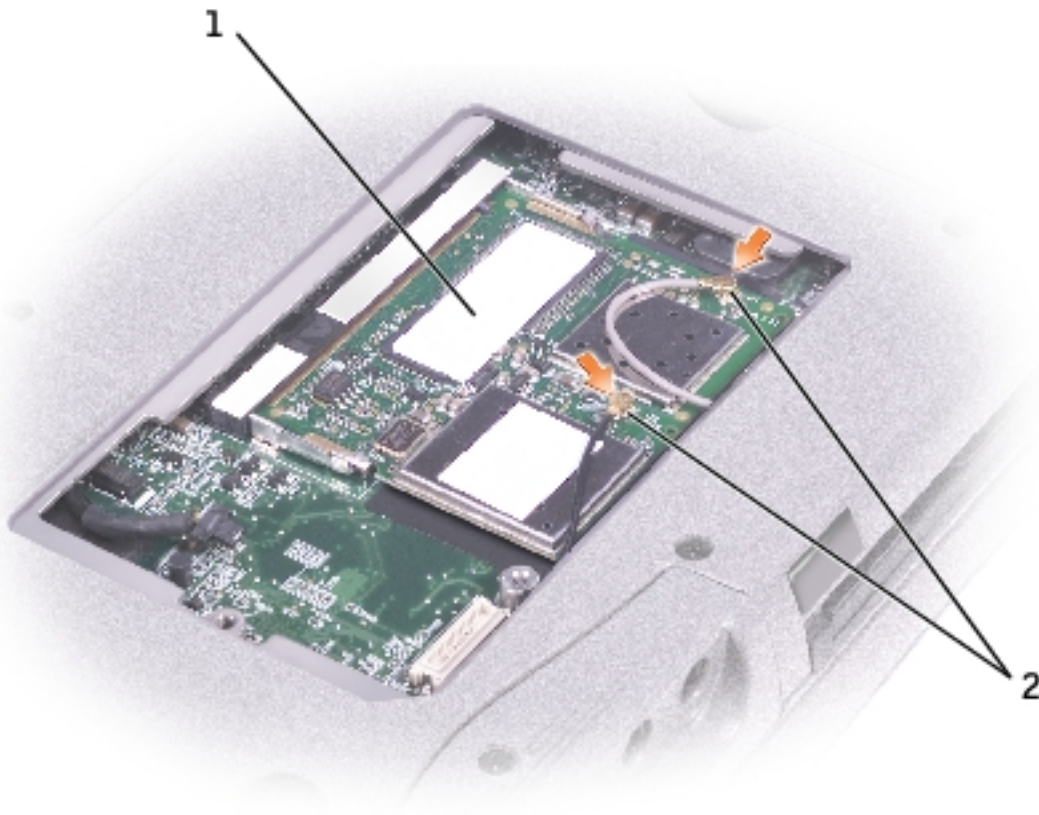

1	Mini PCI card
2	antenna cables (2)

6. Replace the cover and tighten the screw.

## Modem



**CAUTION:** Before working inside your computer, read the safety instructions in your *Owner's Manual*.



**CAUTION:** To prevent static damage to components inside your computer, discharge static electricity from your body before you touch any of your computer's electronic components. You can do so by touching an unpainted metal surface.



**NOTICE:** Handle components and cards by their edges, and avoid touching pins and contacts.

1. Follow the instructions in "[Preparing to Work Inside the Computer](#)."
2. Turn the computer over, and loosen the captive screw from the Mini PCI card/modem cover.

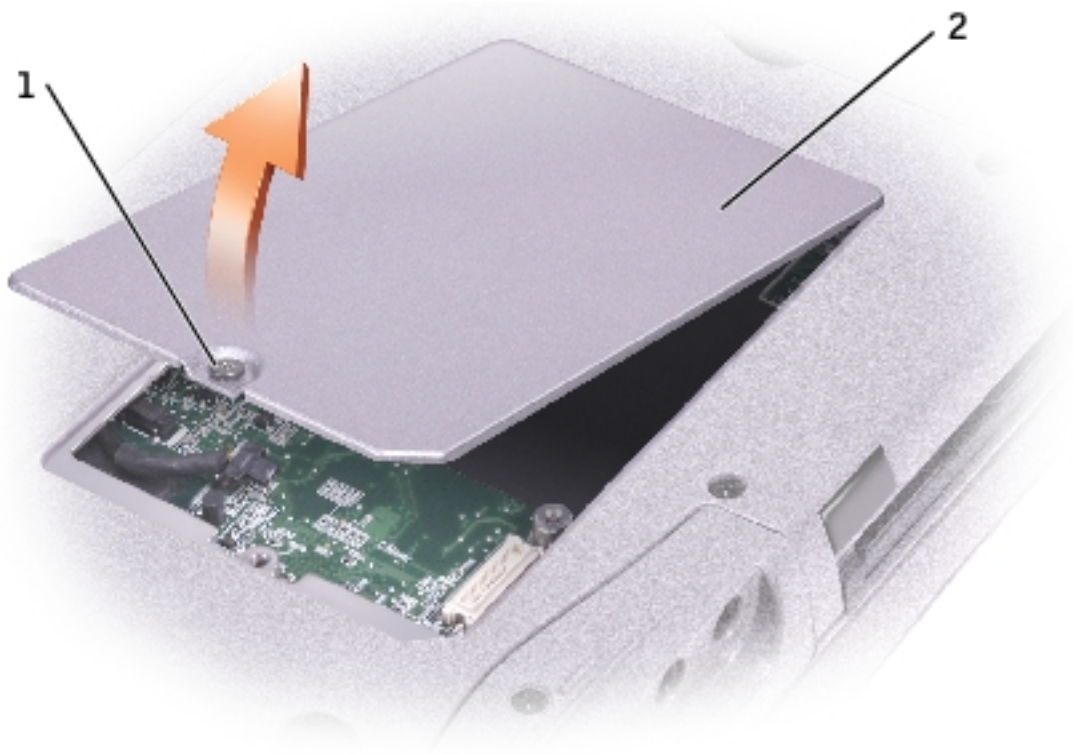

1	captive screw
2	Mini PCI card/modem cover

3. If a modem is not already installed, go to [step 4](#). If you are replacing a modem, remove the existing modem:
  - a. Remove the screws securing the modem to the system board, and set it aside.
  - b. Pull straight up on the attached pull-tab to lift the modem out of its connector on the system board, and disconnect the modem cable.

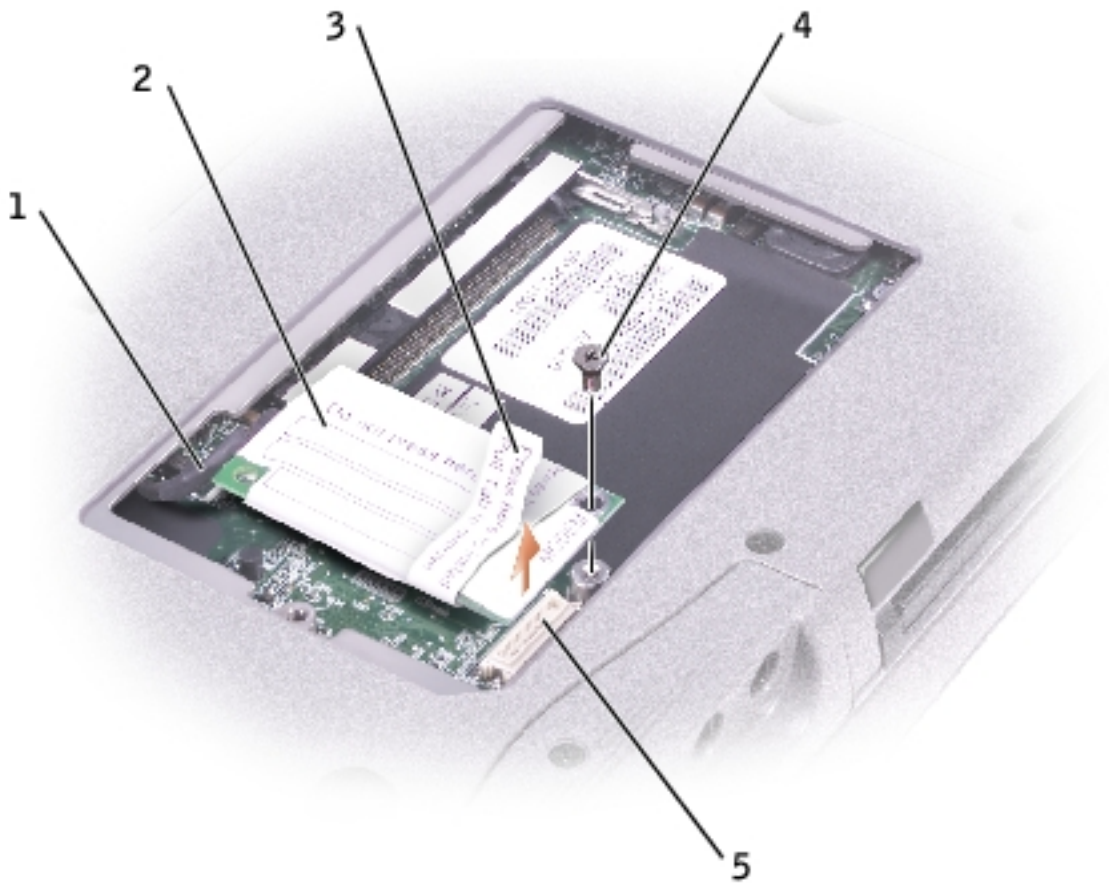

1	modem cable
2	modem
3	pull-tab
4	screw
5	system board connector

**NOTICE:** The cable connectors are keyed for correct insertion; do not force the connections.

4. Connect the modem cable to the modem.

**NOTICE:** To prevent damage to the modem, press the modem into the connector *directly over* the connector.

5. Align the modem with the screw hole, and press the modem into the connector directly over the connector on the system board.

# Modules

Your computer ships with an optical drive installed in the module bay. However, the device screw is not installed in the optical drive but packaged separately. When you install your device in the module bay, you can install the device screw.



**NOTE:** You do not need to install the device screw unless you want to secure the module inside the computer for security purposes.

## If the Device Screw Is Not Installed



**NOTICE:** To prevent damage to devices, place them in a safe, dry place when they are not installed in the computer. Avoid pressing down on them or placing heavy objects on top of them.

1. Press the device latch release so that the latch release pops out.



1	device latch release
---	----------------------

2. Pull the device by the latch release to remove the device from the module bay.



## If the Device Screw Is Installed

1. If the computer is connected to a docking device (docked), undock it. See the documentation that came with your docking device for instructions.

 **NOTICE:** To prevent damage to devices, place them in a safe, dry place when they are not installed in the computer. Avoid pressing down on them or placing heavy objects on top of them.

2. Close the display and turn the computer over.
3. Use a #1 Phillips screwdriver to remove the M2 x 3-mm screw from the bottom of the computer.

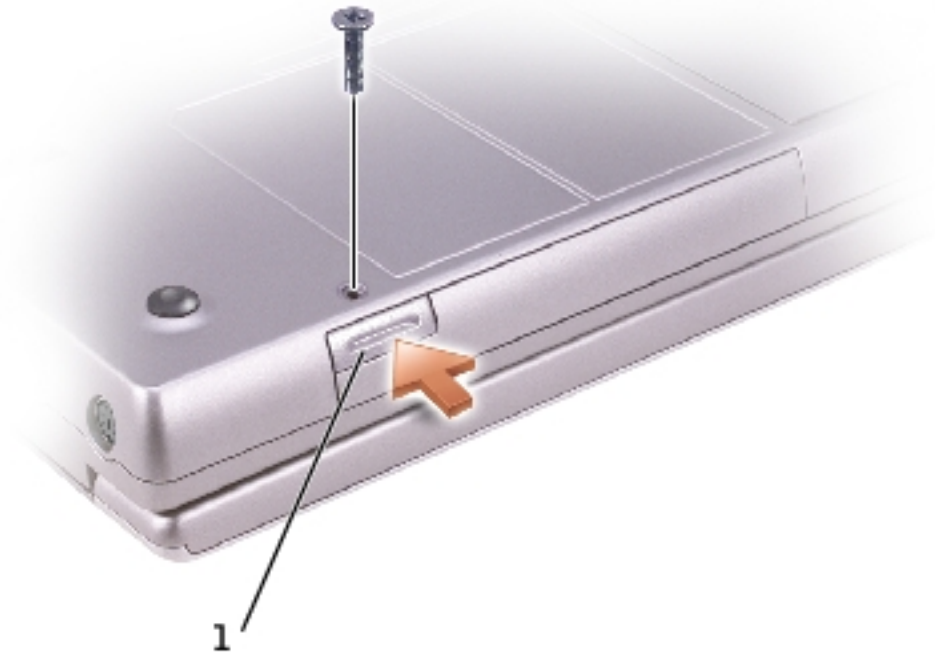

1	device latch release
---	----------------------

4. Press the device latch release so that the latch release pops out.
5. Pull the device by the latch release to remove the device from the module bay.





**NOTICE:** Insert devices into the module bay before you dock and turn on the computer.

---

[Back to Contents Page](#)

[Back to Contents Page](#)

# Color Insert Cover

## Dell™ Inspiron™ 8500/8600 Service Manual

### Removing the Color Insert Cover

1. Press down along the front of the display as shown.



2. Firmly grasp the lip of the cover to detach it from the computer, and pull the cover up.

### Replacing the Color Insert Cover

1. Place the tabs on the cover in the grooves above the display hinges, and lower the cover over the computer.

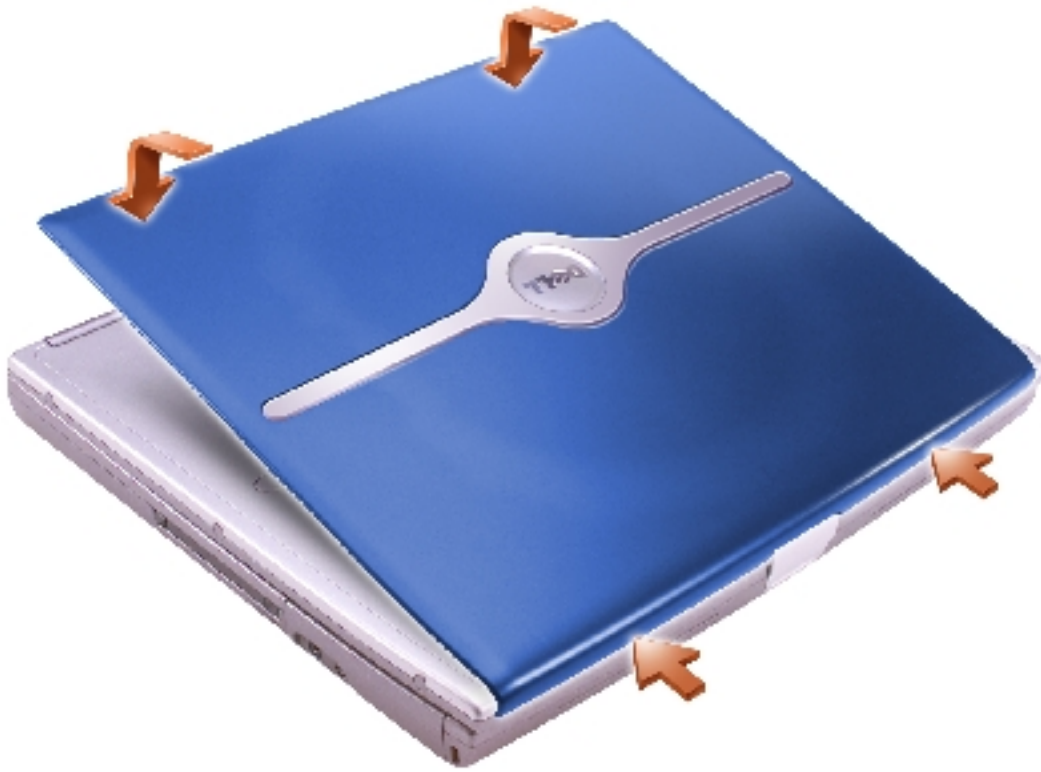

2. Press along the front until the cover snaps into place.

---

[Back to Contents Page](#)

[Back to Contents Page](#)

# Hard Drive

## Dell™ Inspiron™ 8500/8600 Service Manual

 **CAUTION:** If you remove the hard drive from the computer when the drive is hot, do not touch the metal housing of the hard drive.

 **CAUTION:** Before working inside your computer, read the safety instructions in your *Owner's Manual*.

 **NOTICE:** To prevent data loss, shut down your computer before removing the hard drive. Do not remove the hard drive while the computer is on, in standby mode, or in hibernate mode.

 **NOTICE:** Hard drives are extremely fragile; even a slight bump can damage the drive.

 **NOTE:** Dell does not guarantee compatibility or provide support for hard drives from sources other than Dell.

1. Follow the instructions in "[Preparing to Work Inside the Computer](#)."
2. Turn the computer over. Use a standard #1 Phillips screwdriver to remove the M3 x 3-mm screw.



1	M3 x 3-mm screw
---	-----------------



**NOTICE:** When the hard drive is not in the computer, store it in protective antistatic packaging. See "Protecting Against Electrostatic Discharge" in your *Owner's Manual*.

3. Slide the hard drive out of the computer.
- 

[Back to Contents Page](#)

[Back to Contents Page](#)

# Bluetooth™ Card

## Dell™ Inspiron™ 8500/8600 Service Manual



**CAUTION:** Before performing the following procedures, read the safety instructions in your *Owner's Manual*.



**NOTICE:** To avoid electrostatic discharge, ground yourself by using a wrist grounding strap or by periodically touching an unpainted metal surface (such as the back panel) on the computer.

If you ordered a Bluetooth card with your computer, the card is already installed.

1. Remove the [hard drive](#).
2. Pull the Bluetooth card connector out of the system board connector.
3. Pull the cable to remove the Bluetooth card from the computer.

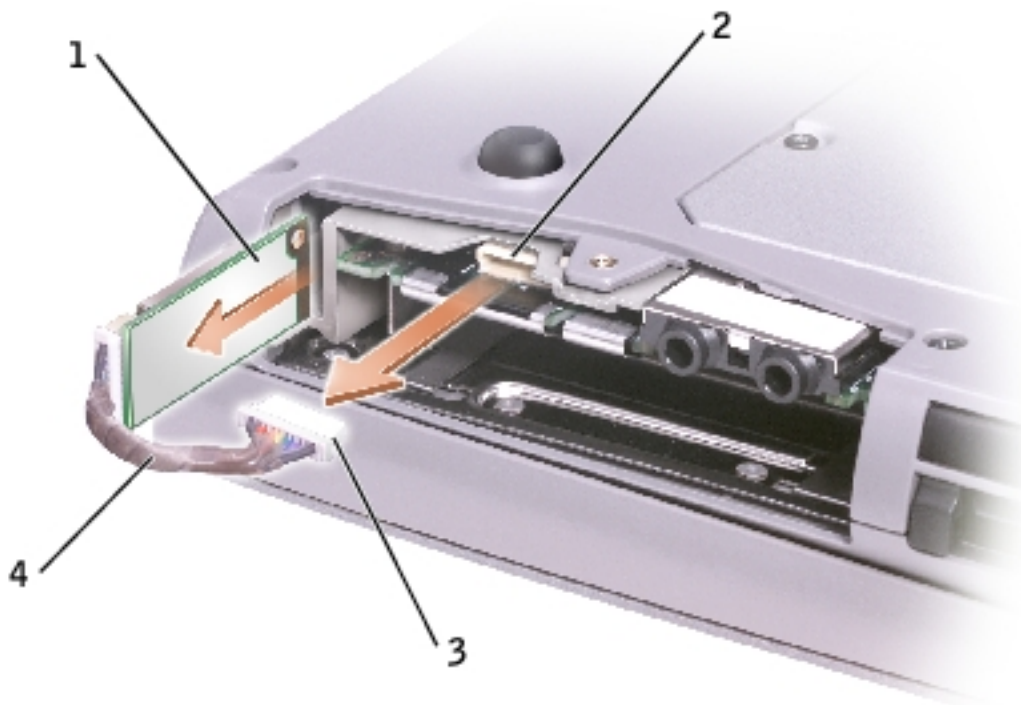

1	Bluetooth card
---	----------------

2	system board connector
3	Bluetooth card connector
4	cable

---

[Back to Contents Page](#)

[Back to Contents Page](#)

# Fan

## Dell™ Inspiron™ 8500/8600 Service Manual



**CAUTION:** Before performing the following procedures, read the safety instructions in your *Owner's Manual*.



**NOTICE:** To avoid electrostatic discharge, ground yourself by using a wrist grounding strap or by periodically touching an unpainted metal surface (such as the back panel) on the computer.

1. Follow the instructions in "[Preparing to Work Inside the Computer](#)."
2. Remove the two M2.5 x 12 screws from the fan cover.

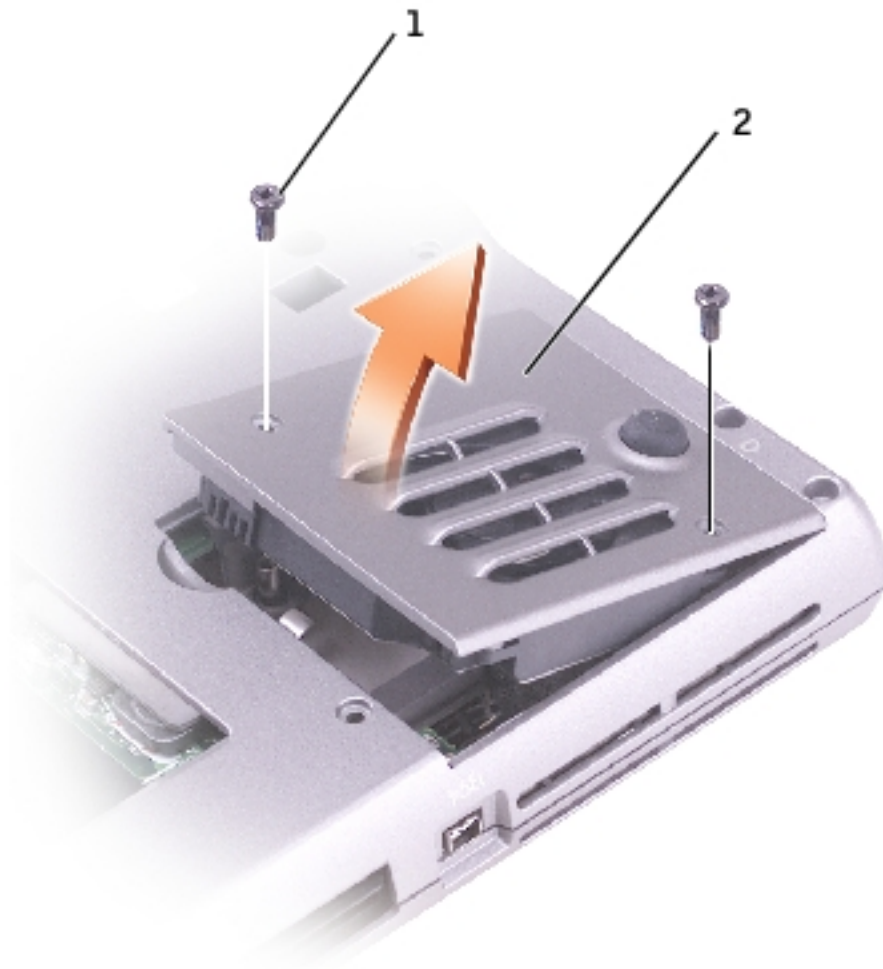



1	M2.5 x 12-mm screws (2)
2	fan cover

3. Lift the fan out of the computer.

---

[Back to Contents Page](#)

[Back to Contents Page](#)

# Docking Doors

## Dell™ Inspiron™ 8500/8600 Service Manual

### Removing the Docking Doors

 **CAUTION:** Before working inside your computer, read the safety instructions in your *Owner's Manual*.

 **NOTICE:** To avoid electrostatic discharge, ground yourself by using a wrist grounding strap or by periodically touching an unpainted metal surface (such as the back panel) on the computer.

1. Follow the instructions in "[Preparing to Work Inside the Computer](#)."
2. Gently bend the docking covers and lift them away from the computer base.



### Installing the Docking Doors

Slide the side of the docking covers with the spring over the longer posts.



1	docking doors with spring
2	longer post

---

[Back to Contents Page](#)

[Back to Contents Page](#)

# Keyboard

## Dell™ Inspiron™ 8500/8600 Service Manual



**CAUTION:** Before performing the following procedures, read the safety instructions in your *Owner's Manual*.



**NOTICE:** To avoid electrostatic discharge, ground yourself by using a wrist grounding strap or by periodically touching an unpainted metal surface (such as the back panel) on the computer.

1. Follow the instructions in "[Preparing to Work Inside the Computer](#)."
2. Turn the computer right-side up and open it.



1	display
---	---------

2	center control cover
3	computer base

3. Remove the center control cover:

- a. Open the display all the way (180 degrees) so that it lies flat against your work surface.
- b. Starting on the left side of the computer, use a plastic scribe or flat-blade screw driver to pry up the center control cover.
- c. Disconnect the center-control-cover flex cable from the system board connector using the pull-tab.
- d. Lift the center control cover away from the computer, and lay it aside.

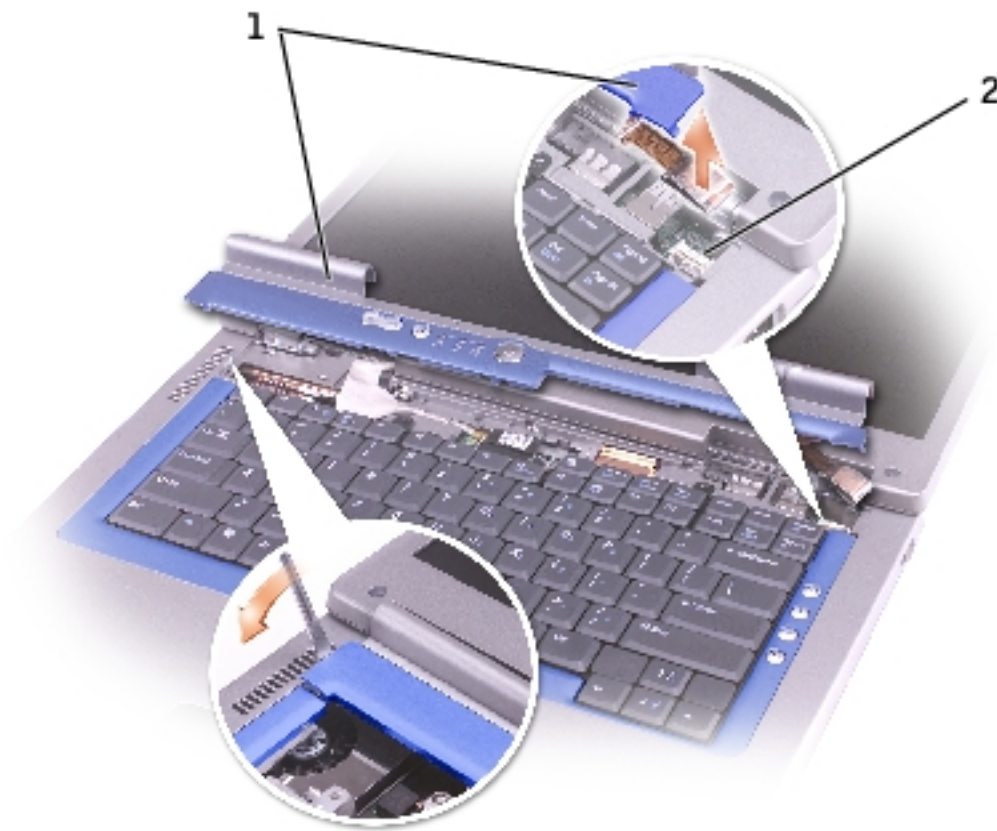

1	center control cover
2	system board connector

4. Remove the keyboard:

- a. Remove the two M2.5 x 6-mm screws across the top of the keyboard.

 **NOTICE:** The keycaps on the keyboard are fragile, easily dislodged, and time-consuming to replace. Be careful when removing and handling the keyboard.

- b. Rotate the keyboard up and slide it forward.
- c. Hold the keyboard up and slightly forward to allow access to the keyboard connector.
- d. Pull up on the keyboard connector tab to disconnect the keyboard connector from the system board.



1	M2.5 x 6-mm screws (2)
2	keyboard
3	palm rest

[Back to Contents Page](#)

[Back to Contents Page](#)

# Display Assembly

## Dell™ Inspiron™ 8500/8600 Service Manual

 [Display Assembly](#)

 [Display Bezel](#)

 [Display Panel](#)

---

## Display Assembly



**CAUTION:** Before performing the following procedures, read the safety instructions in your *Owner's Manual*.



**NOTICE:** To avoid electrostatic discharge, ground yourself by using a wrist grounding strap or by periodically touching an unpainted metal surface (such as the back panel) on the computer.



**NOTICE:** You must remove the display assembly before you remove the palm rest.

1. Follow the instructions in "[Preparing to Work Inside the Computer](#)."
2. Turn the computer over and remove the two M2.5 x 12-mm screws labeled "D" on the bottom of the computer.

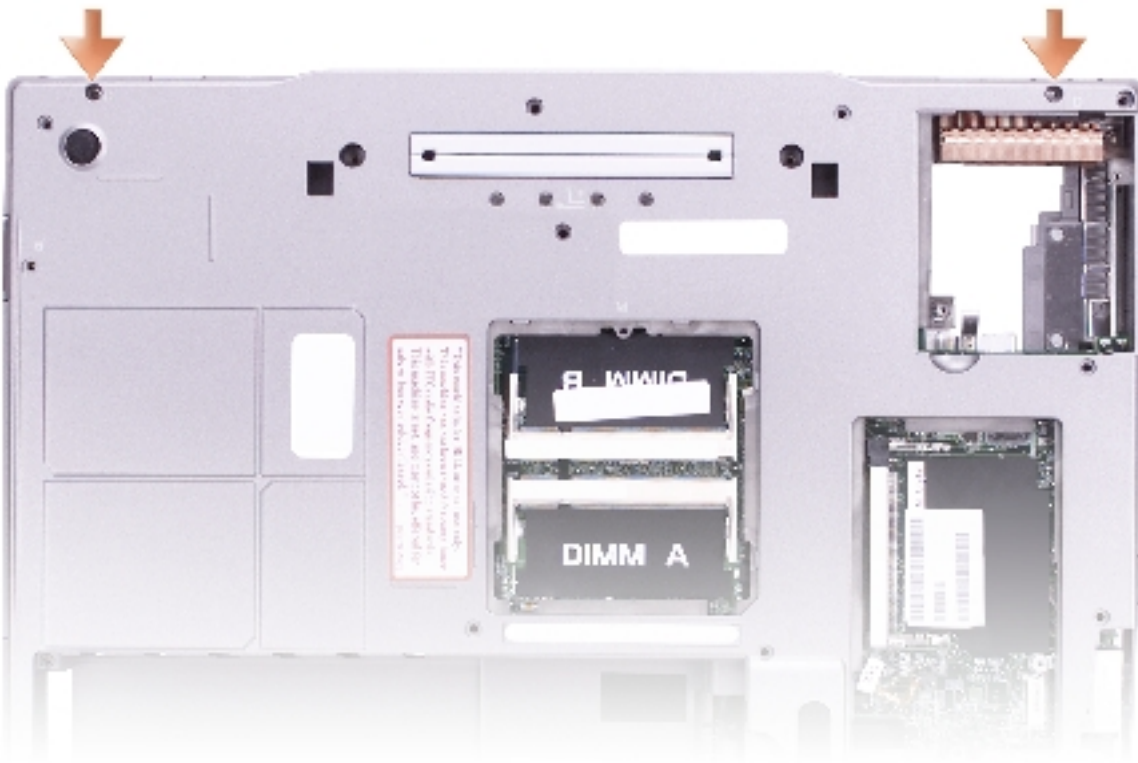

3. Turn over the computer and open the display.
4. Remove the [central control cover](#).
5. Disconnect the display cable using the pull-tab, and release the cable from the four cable-routing clips.



**NOTE:** When you replace the display assembly, ensure that you route the display cable under the EMI clip and cable-routing clips.

6. Lift the display out of the computer.



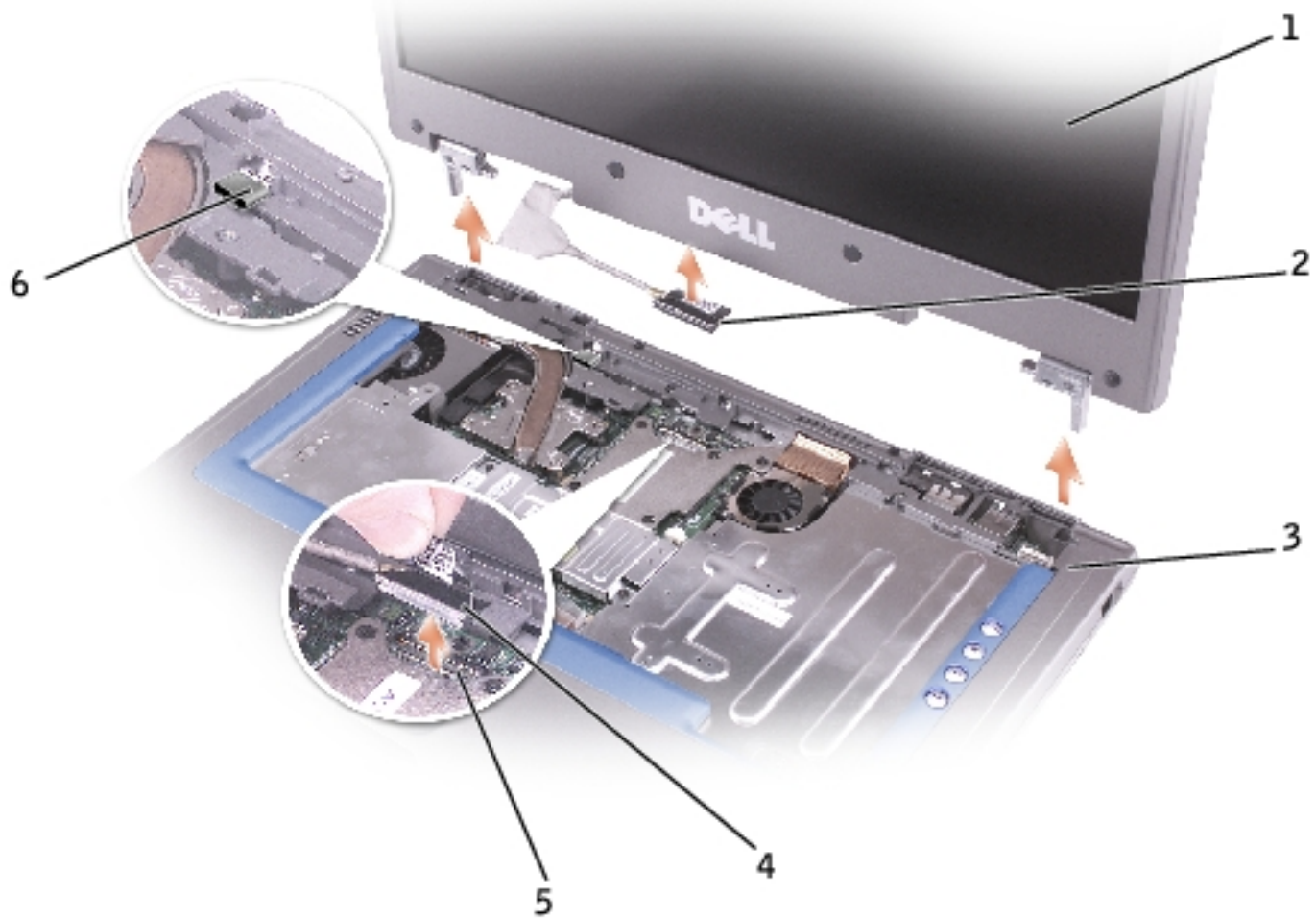

1	display
2	display cable connector
3	computer base
4	pull-tab
5	connector
6	EMI clip

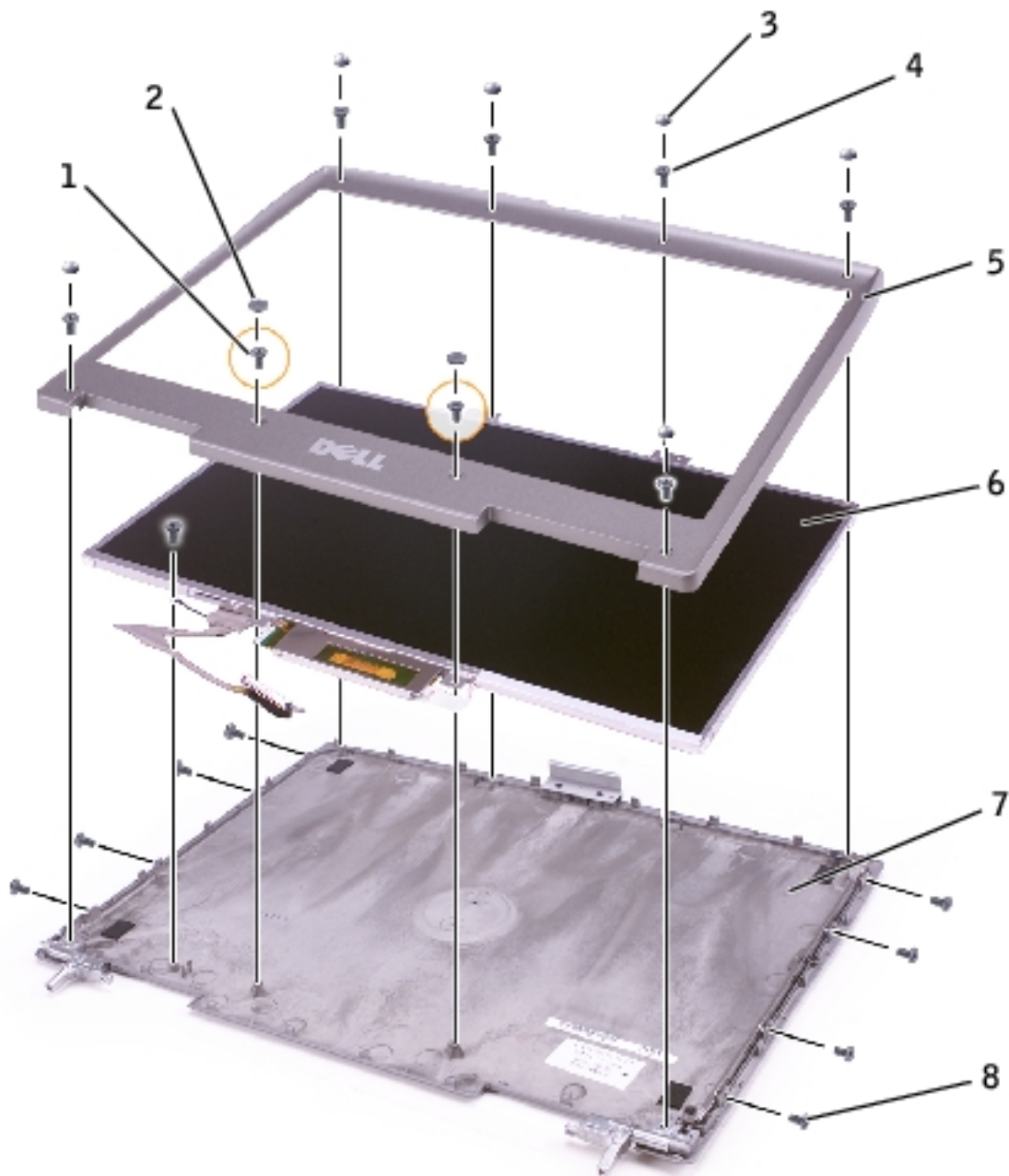

1	M2.5 x 4.5-mm shoulder screws (2)	5	display bezel
2	shoulder screw covers (2)	6	display panel
3	display bumpers (6)	7	top cover
4	M2.5 x 6-mm screws (6)	8	M2 x 3-mm screws (9)

## Display Bezel



**CAUTION:** Before performing the following procedures, read the safety instructions in your *Owner's Manual*.



**NOTICE:** To avoid electrostatic discharge, ground yourself by using a wrist grounding strap or by periodically touching an unpainted metal surface (such as the back panel) on the computer.

1. Follow the instructions in "[Preparing to Work Inside the Computer](#)."
2. Remove the [central control cover](#).
3. Remove the [display assembly](#).
4. Use a plastic scribe to pry the eight display bumpers out of the screw holes located on the front of the bezel.
5. Remove the eight M2.5 x 6-mm screws located on the front of the bezel.



**NOTICE:** Carefully separate the bezel from the top cover to avoid damage to the bezel.

6. Starting at the bottom of the display panel (by the DELL™ logo), use your fingers to separate the bezel from the top cover by lifting the inside edge of the bezel away from the top cover.

---

## Display Panel



**CAUTION:** Before performing the following procedures, read the safety instructions in your *Owner's Manual*.



**NOTICE:** To avoid electrostatic discharge, ground yourself by using a wrist grounding strap or by touching an unpainted metal surface on the computer.

1. Follow the instructions in "[Preparing to Work Inside the Computer](#)."
2. Remove the [central control cover](#).
3. Remove the [display assembly](#).
4. Remove the [display bezel](#).
5. Remove the nine M2 x 3-mm screws from the display panel.
6. Lift the display panel, and rotate the display panel out of the top cover.
7. Remove the yellow tape from the top display connector.
8. Press in the tabs on both sides of the top display-cable connector, and pull the display cable

connector away from the top flex-cable connector.

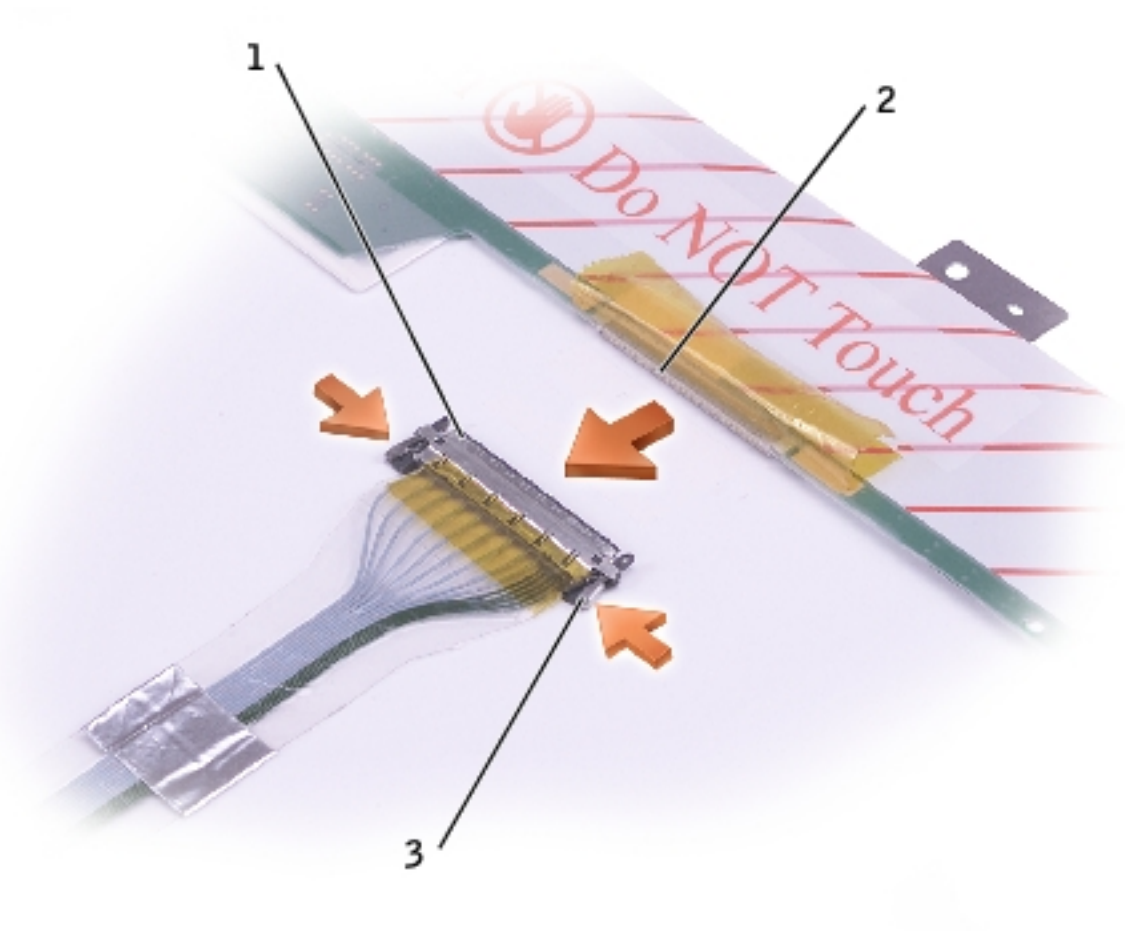

1	top flex-cable connector
2	top display-cable connector
3	tabs

9. Use the pull-tab to disconnect the bottom flex-cable connector from the inverter connector.

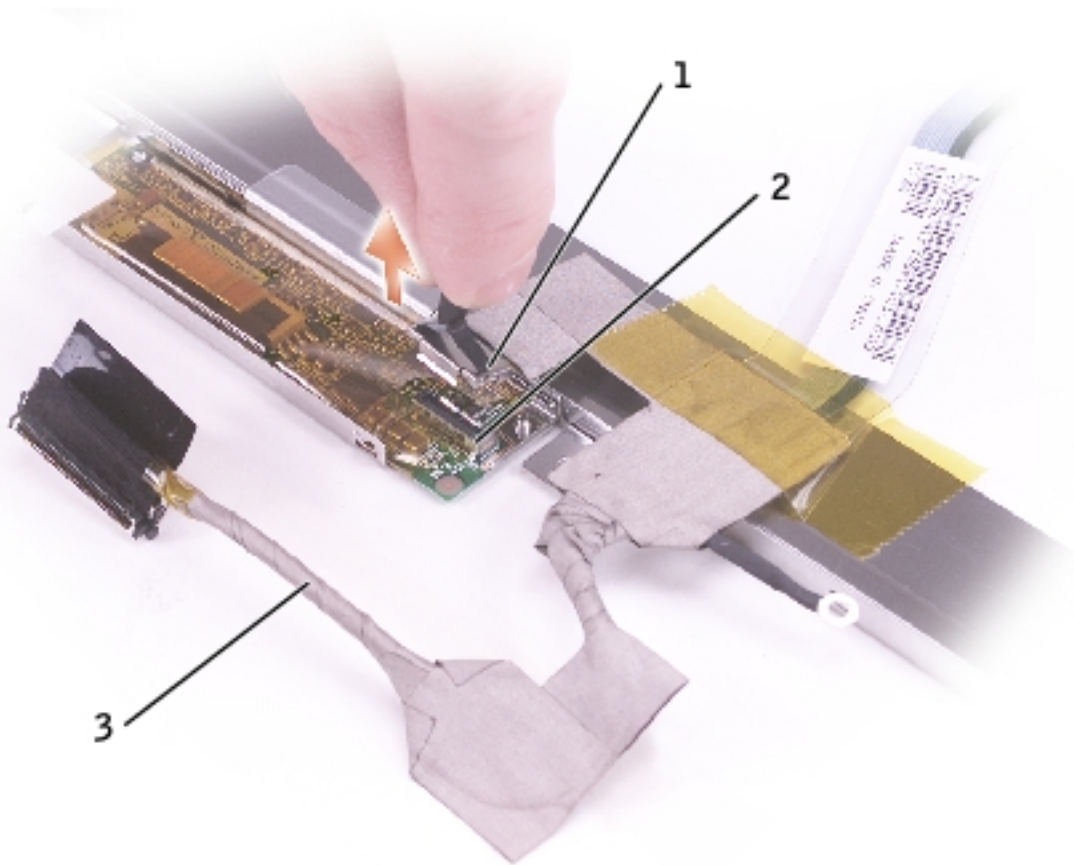

1	top flex-cable connector
2	top display-cable connector
3	pull-tab on bottom flex-cable connector

10. Remove the yellow tape from above the bottom flex-cable connector.

[Back to Contents Page](#)

[Back to Contents Page](#)

# Video Card

## Dell™ Inspiron™ 8500/8600 Service Manual

 **CAUTION:** Before performing the following procedures, read the safety instructions in your *Owner's Manual*.

 **NOTICE:** To avoid electrostatic discharge, ground yourself by using a wrist grounding strap or by periodically touching an unpainted metal surface (such as the back panel) on the computer.

1. Follow the instructions in "[Preparing to Work Inside the Computer](#)."
2. Remove the [keyboard](#).
3. Remove the [display](#).
4. Remove the four M2.5 x 6-mm screws from the video card.

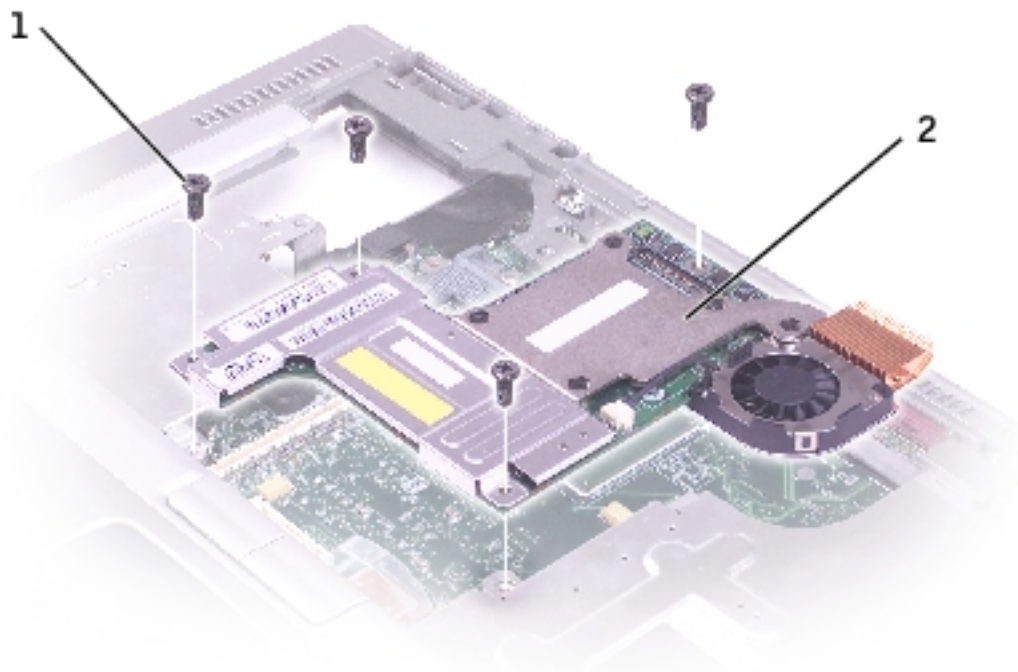

1	M2.5 x 6-mm screws (4)
2	video card

5. Lift the video card out of the computer.
- 

[Back to Contents Page](#)

[Back to Contents Page](#)

# Microprocessor Thermal-Cooling Assembly

Dell™ Inspiron™ 8500/8600 Service Manual

## Removing the Microprocessor Thermal-Cooling Assembly



**CAUTION:** Before performing the following procedures, read the safety instructions in your *Owner's Manual*.



**NOTICE:** To avoid electrostatic discharge, ground yourself by using a wrist grounding strap or by periodically touching an unpainted metal surface (such as the back panel) on the computer.



**NOTICE:** Disconnect the computer and any attached devices from electrical outlets, and remove any installed batteries.

1. Follow the instructions in "[Preparing to Work Inside the Computer](#)."
2. Remove the [keyboard](#).
3. Remove the [fan](#).
4. Loosen in consecutive order the four captive screws, labeled "1" through "4," that secure the microprocessor thermal-cooling assembly to the system board.



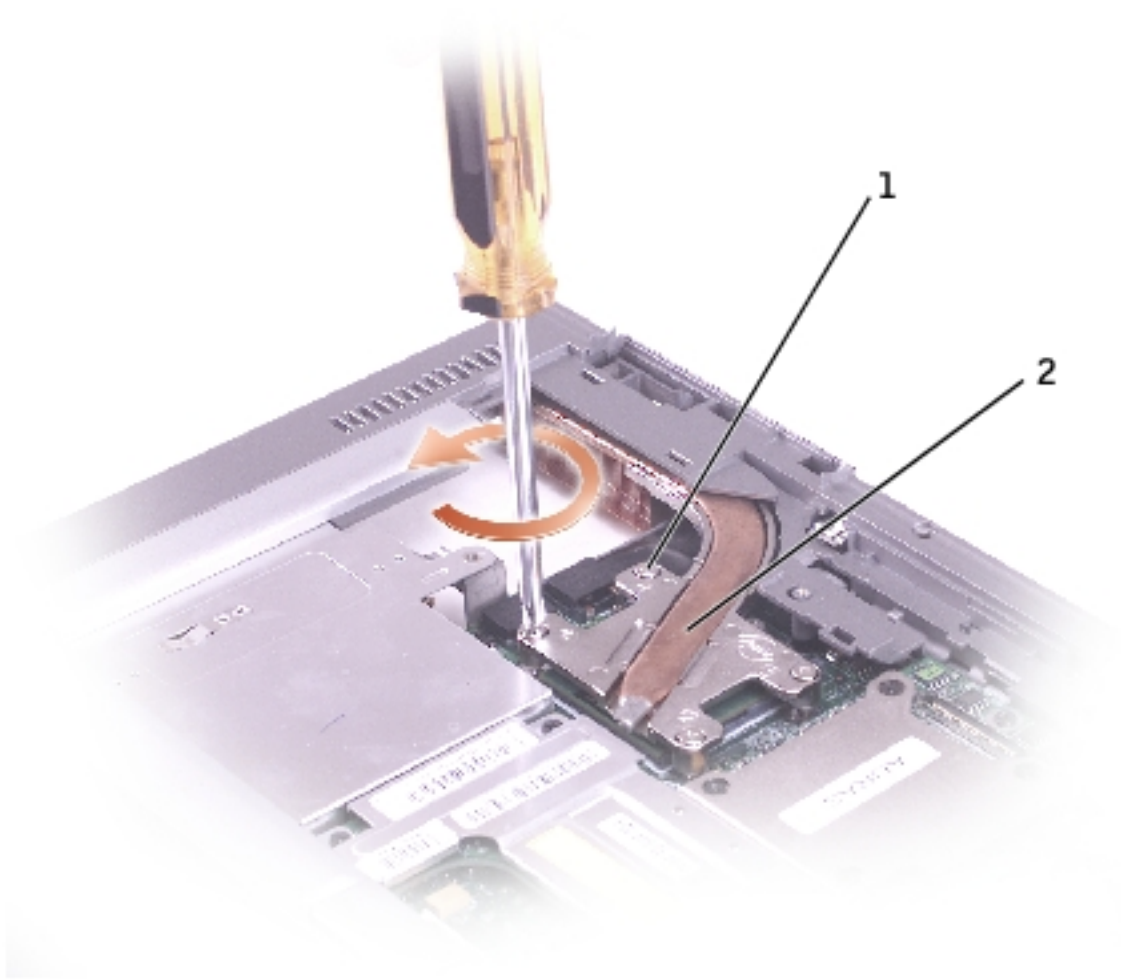

1	captive screws (4)
2	microprocessor thermal-cooling assembly

5. Rotate the microprocessor thermal-cooling assembly up toward the side of the computer and away from the system board.

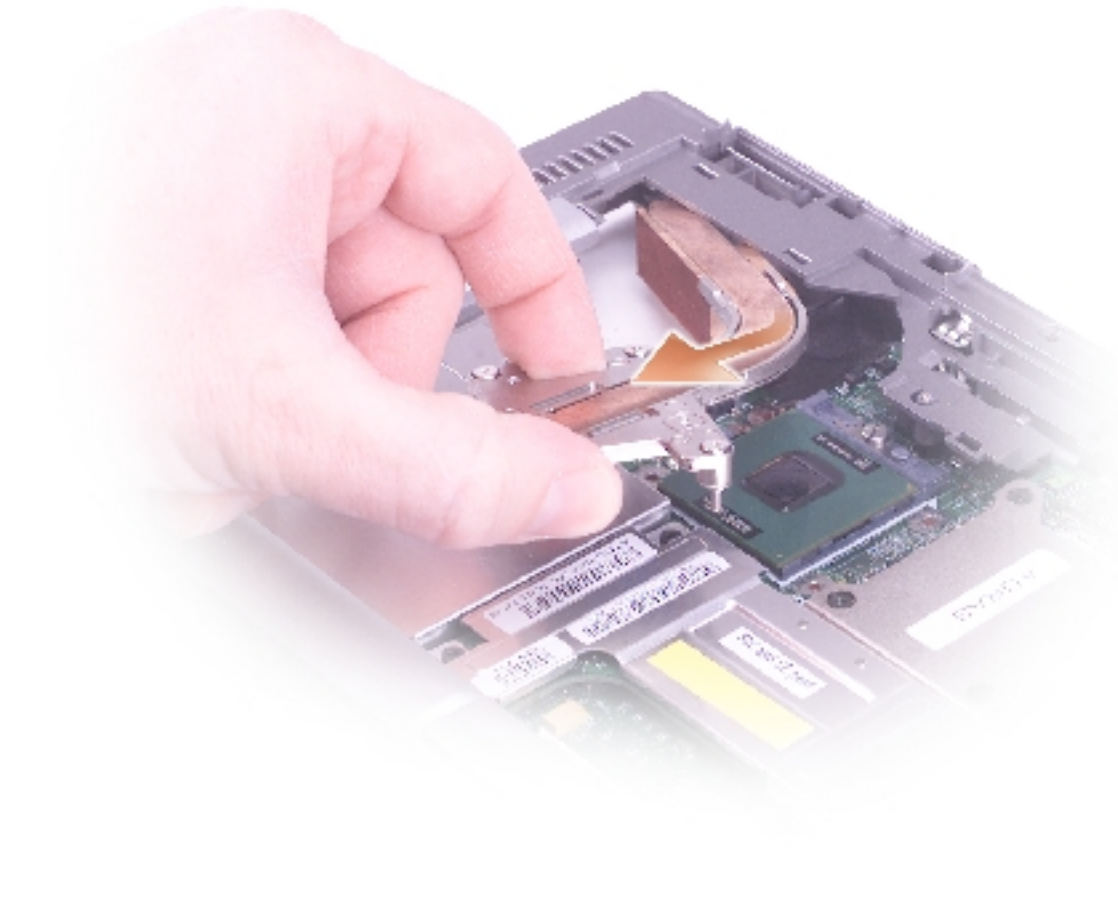

## Installing the Microprocessor Thermal-Cooling Assembly

1. Place the left side of the microprocessor thermal-cooling assembly under the palm rest and rotate the assembly onto the system board.
2. Tighten the four captive screws, labeled "1" through "4," in consecutive order.

---

[Back to Contents Page](#)

[Back to Contents Page](#)

# Palm Rest

## Dell™ Inspiron™ 8500/8600 Service Manual



**CAUTION:** Before performing the following procedures, read the safety instructions in your *Owner's Manual*.



**NOTICE:** To avoid electrostatic discharge, ground yourself by using a wrist grounding strap or by periodically touching an unpainted metal surface (such as the back panel) on the computer.

1. Follow the instructions in "[Preparing to Work Inside the Computer](#)."
2. Remove the [keyboard](#).



**NOTICE:** You must remove the display assembly before you remove the palm rest; the display hinges pass through the back of the palm rest.

3. Remove the [display assembly](#).
4. Remove the [microprocessor thermal-cooling assembly](#).
5. Remove the [video card](#).
6. Remove the 13 M2.5 x 12-mm screws from the bottom of the computer.

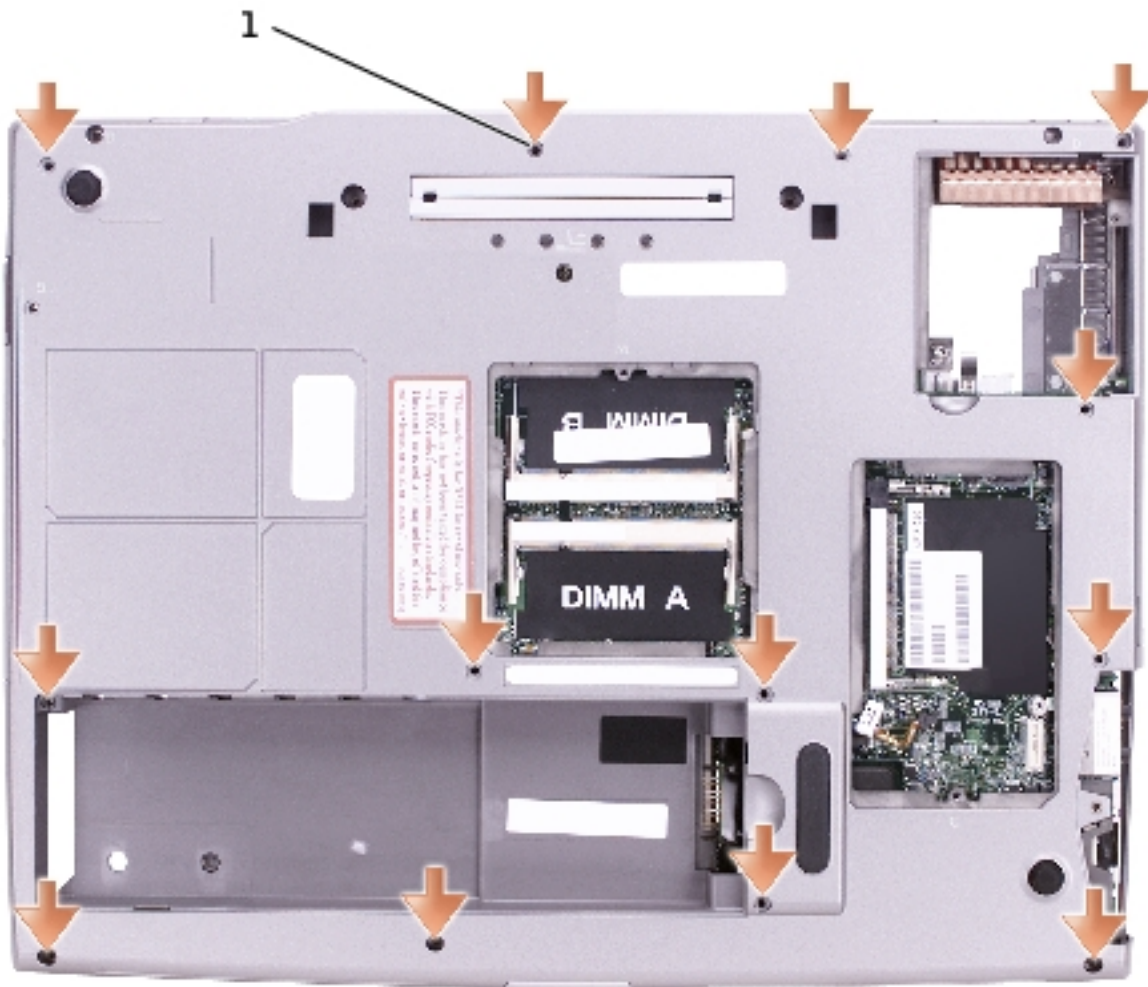

1	M2.5 x 12-mm screws (13)
---	--------------------------

7. Remove the two M2.5 x 4-mm screws from the top of the palm rest.

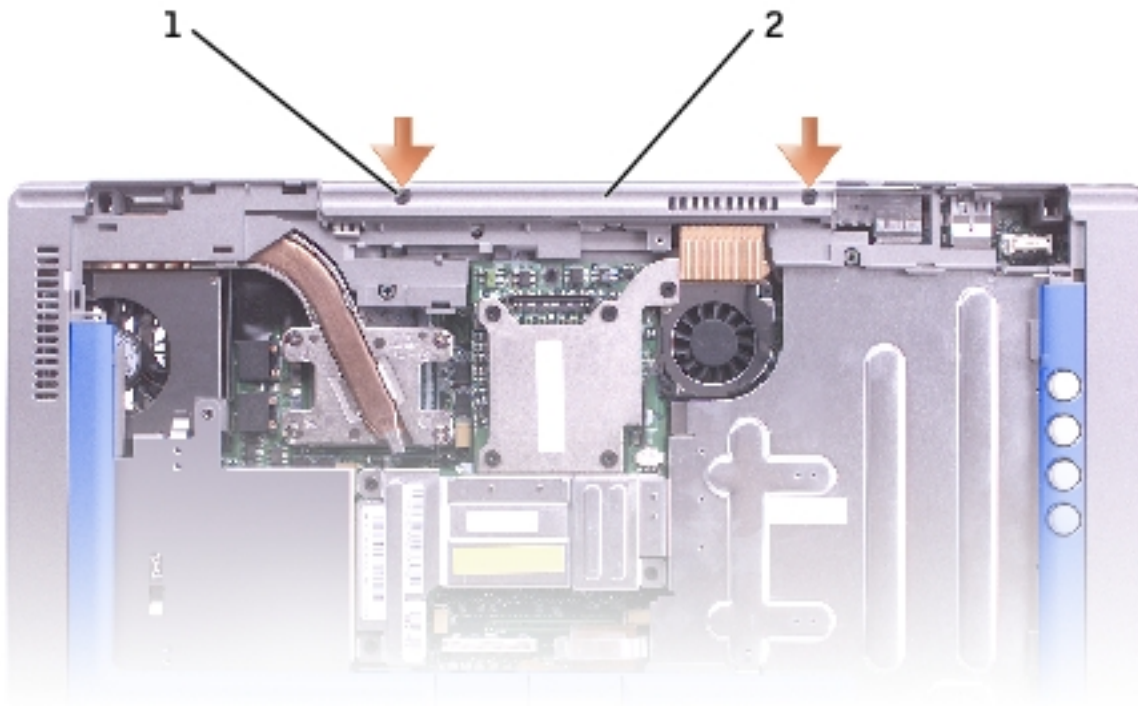

1	M2.5 x 4-mm screws (2)
2	top of the palm rest

8. Disconnect the touch pad connector from the system board.

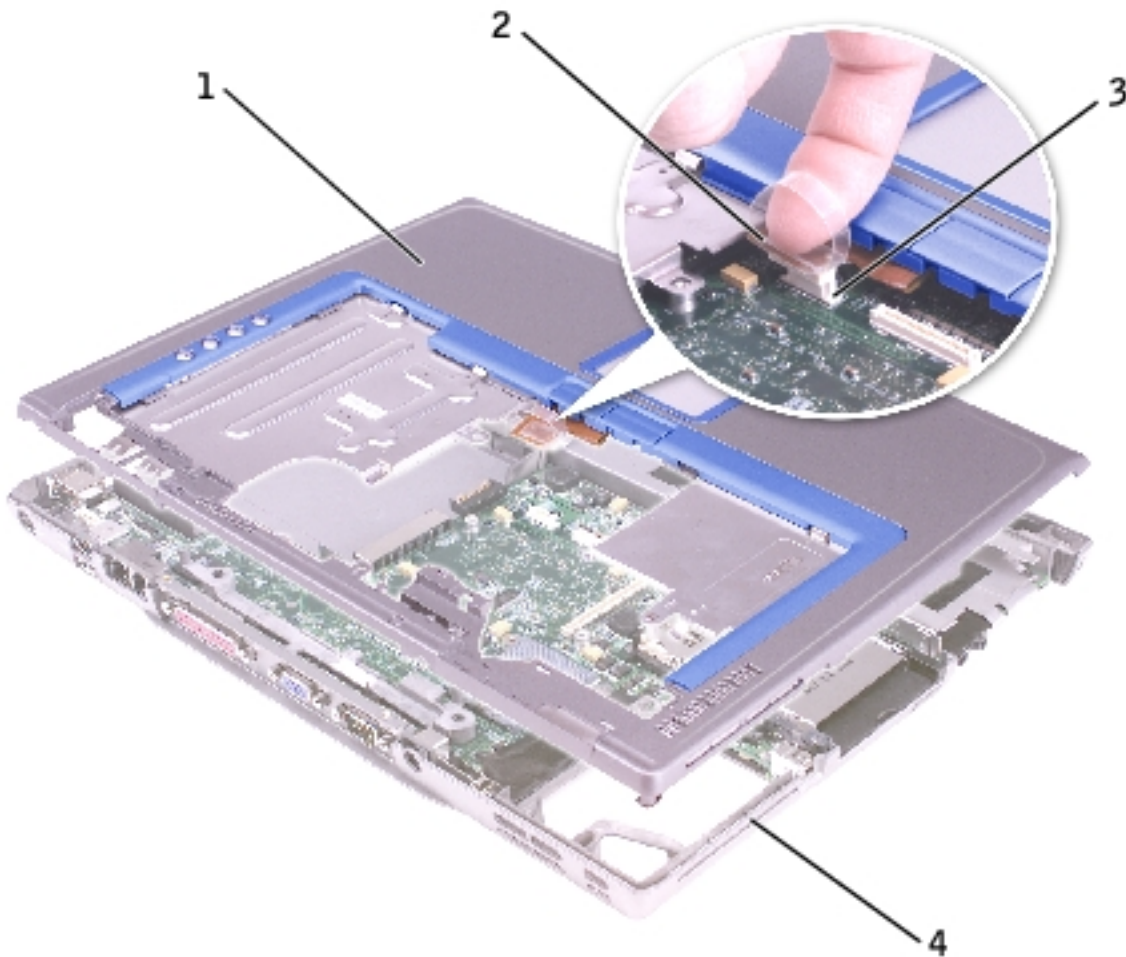

1	back center of the palm rest
2	touch pad connector
3	system board connector
4	computer base

 **NOTICE:** Carefully separate the palm rest from the computer base to avoid damage to the palm rest.

9. Use your fingers to separate the palm rest from the computer base.

---

[Back to Contents Page](#)

[Back to Contents Page](#)

# Microprocessor Module

## Dell™ Inspiron™ 8500/8600 Service Manual

### Removing the Microprocessor Module



**CAUTION:** Before performing the following procedures, read the safety instructions in your *Owner's Manual*.



**NOTICE:** To avoid electrostatic discharge, ground yourself by using a wrist grounding strap or by periodically touching an unpainted metal surface (such as the back panel) on the computer.



**NOTICE:** Do not touch the processor die. Press and hold the microprocessor down on the substrate on which the die is mounted while turning the cam screw to prevent intermittent contact between the cam screw and microprocessor.



**NOTICE:** To avoid damage to the microprocessor, hold the screwdriver so that it is perpendicular to the microprocessor when turning the cam screw.

1. Follow the instructions in "[Preparing to Work Inside the Computer](#)."
2. Remove the [keyboard](#).
3. Remove the [fan](#).



**NOTICE:** To ensure maximum cooling for the microprocessor, do not touch the heat transfer areas on the microprocessor thermal-cooling assembly. The oils in your skin reduce the heat transfer capability of the thermal pads.

4. Remove the [microprocessor thermal-cooling assembly](#).



**NOTICE:** When removing the microprocessor module, pull the module straight up. Be careful not to bend the pins on the microprocessor module.

5. To loosen the ZIF socket, use a small, flat-blade screwdriver and rotate the ZIF-socket cam screw counterclockwise until it comes to the cam stop.

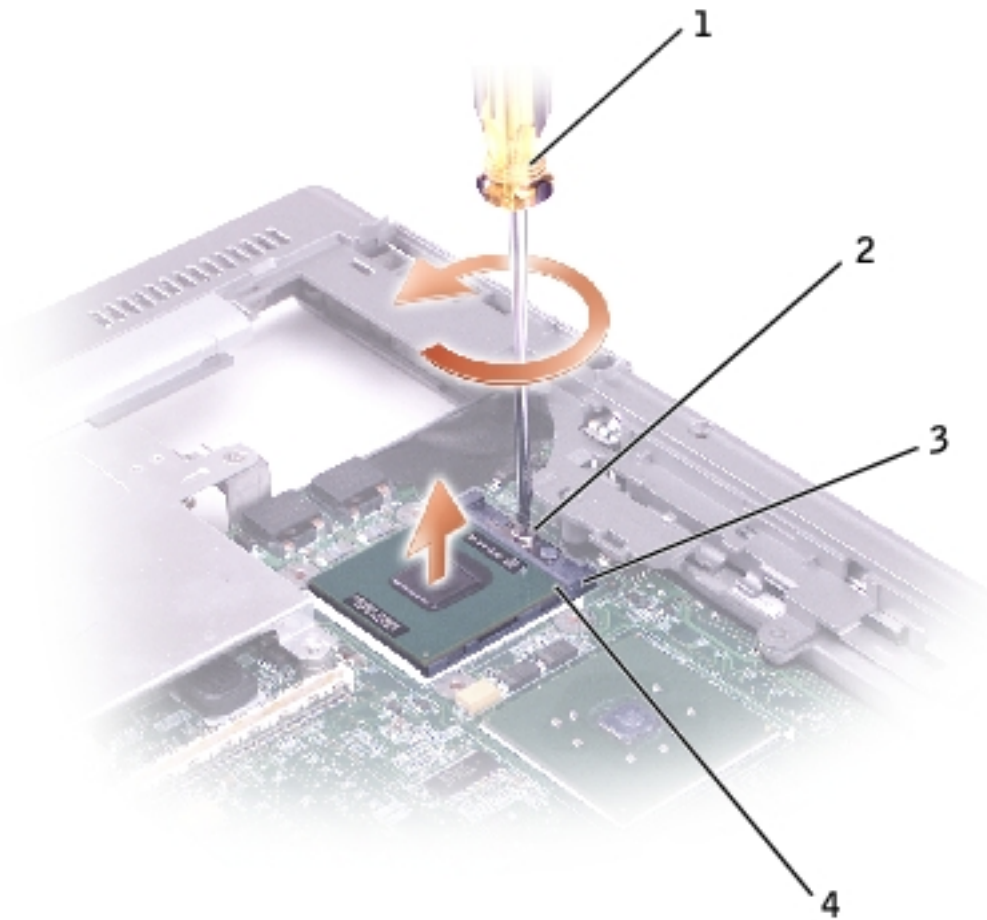

1	screwdriver (perpendicular to microprocessor)
2	ZIF-socket cam screw
3	ZIF socket
4	pin-1 corner



**NOTE:** The ZIF-socket cam screw secures the microprocessor to the system board. Take note of the arrow on the ZIF-socket cam screw, which indicates the direction to turn the cam screw.

6. Lift out the microprocessor module.

## Installing the Microprocessor Module





**NOTICE:** Ensure that the cam lock is in the fully open position before seating the microprocessor module. Seating the microprocessor module properly in the ZIF socket does not require force.



 **NOTICE:** A microprocessor module that is not properly seated can result in an intermittent connection or permanent damage to the microprocessor and ZIF socket.

1. Align the pin-1 corner of the microprocessor module with the pin-1 corner of the ZIF socket, and insert the microprocessor module.

 **NOTE:** The pin-1 corner of the microprocessor module has a triangle that aligns with the triangle on the pin-1 corner of the ZIF socket.

 **NOTICE:** You must position the microprocessor module correctly in the ZIF socket to avoid permanent damage to the module and the socket.

When the microprocessor module is correctly seated, all four corners are aligned at the same height. If one or more corners of the module are higher than the others, the module is not seated correctly.

2. Tighten the ZIF socket by turning the cam screw clockwise to secure the microprocessor module to the system board.
3. Perform the steps in "[Removing the Microprocessor Module](#)" in reverse order, beginning with [step 4](#).
4. Update the BIOS using a flash BIOS update program floppy disk or CD. For instructions on how to flash the BIOS, see "[Flashing the BIOS](#)."

---

[Back to Contents Page](#)





[Back to Contents Page](#)

# Flashing the BIOS

## Dell™ Inspiron™ 8500/8600 Service Manual

1. Ensure that the AC adapter is plugged in and that the main battery is installed properly.
2. Insert the flash BIOS update program floppy disk or CD and turn on the computer.

Follow the instructions that appear on the screen. The computer continues to boot and updates the new BIOS. When the update is complete, the computer will automatically reboot.

3. Press  during POST to enter the system setup program.
4. Press  and  to reset the computer defaults.
5. Press , select **Save changes and reboot**, and press  to save configuration changes.
6. Remove the flash BIOS update program floppy disk or CD from the drive and restart the computer.

---

[Back to Contents Page](#)

[Back to Contents Page](#)

# Reserve Battery

## Dell™ Inspiron™ 8500/8600 Service Manual



**CAUTION:** Before working inside your Dell™ computer, read the safety instructions in your *Owner's Manual*.



**NOTICE:** To avoid electrostatic discharge, ground yourself by using a wrist grounding strap or by periodically touching an unpainted metal surface (such as the back panel) on the computer.

1. Follow the instructions in "[Preparing to Work Inside the Computer](#)."
2. Remove the [battery](#).
3. Depress the battery latch and rotate it out to remove the reserve battery cover.

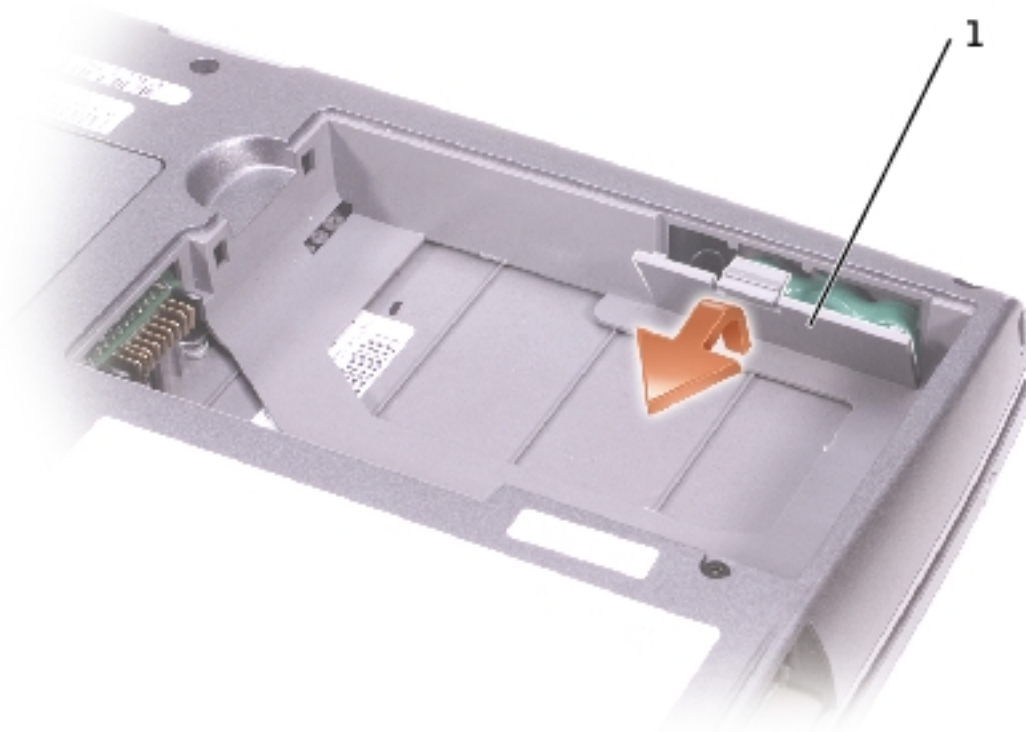

1

reserve battery cover

4. Pull the reserve battery straight out of the computer base.

5. Disconnect the reserve battery cable connector from the speaker connector.

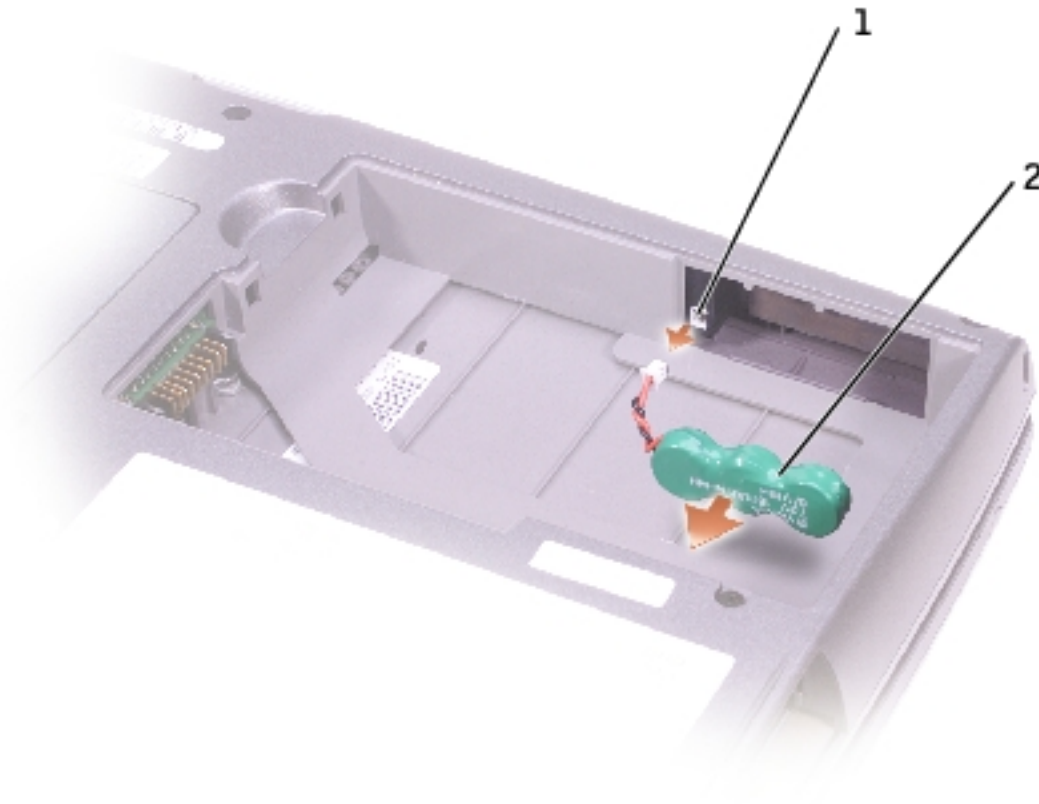

1	speaker connector
2	reserve battery

---

[Back to Contents Page](#)

[Back to Contents Page](#)

# System Board

## Dell™ Inspiron™ 8500/8600 Service Manual

### Removing the System Board



**CAUTION:** Before performing the following procedures, read the safety instructions in your *Owner's Manual*.



**NOTICE:** To avoid electrostatic discharge, ground yourself by using a wrist grounding strap or by periodically touching an unpainted metal surface (such as the back panel) on the computer.

The system board's BIOS chip contains the Service Tag, which is also visible on a barcode label on the bottom of the computer. The replacement kit for the system board includes a CD that provides a utility for transferring the Service Tag to the replacement system board.



**NOTICE:** Disconnect the computer and any attached devices from electrical outlets, and remove any installed batteries.

1. Follow the instructions in "[Preparing to Work Inside the Computer](#)."
2. Remove the [keyboard](#).
3. Remove the [display assembly](#).
4. Remove the [palm rest](#).
5. Remove the [video card](#).
6. Remove the [microprocessor thermal-cooling assembly](#).
7. Remove the [microprocessor](#).
8. Remove the two M2.5 x 6-mm screws from the system board support.

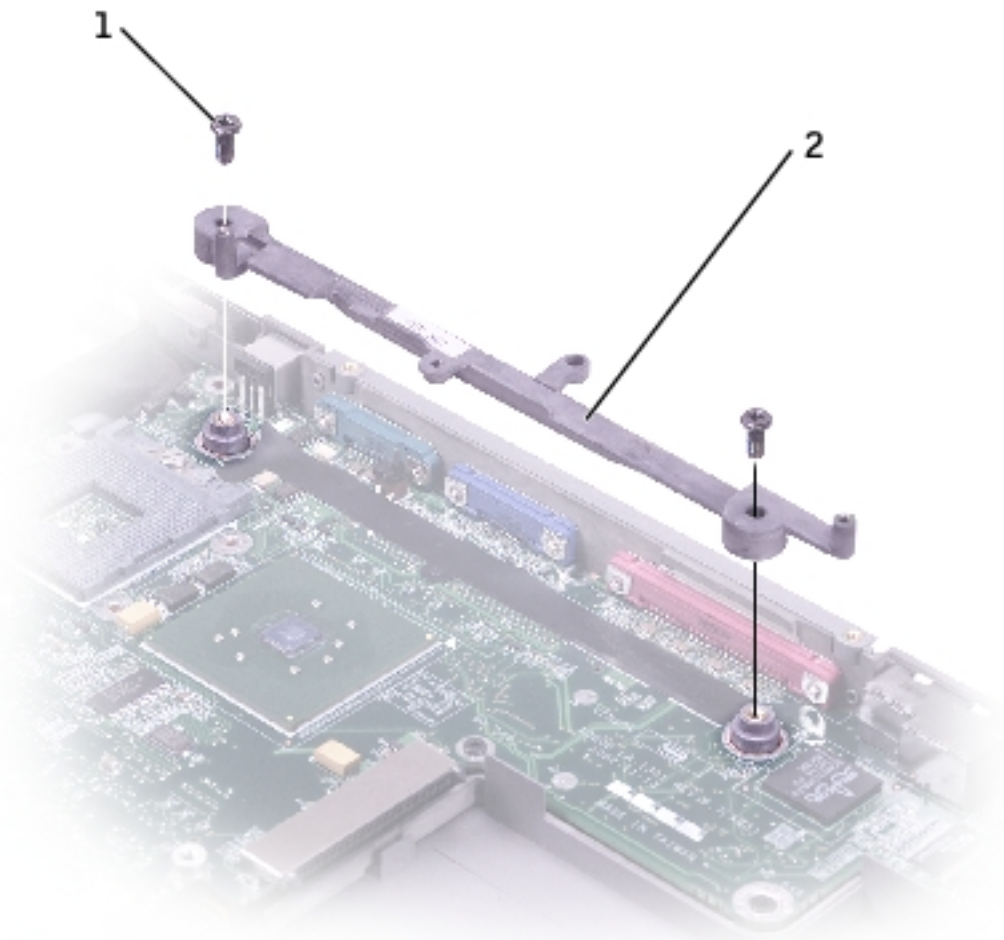

1	M2.5 x 6-mm screws (2)
2	system board support

9. Disconnect the speaker cable.

10. Remove the three M2.5 x 4-mm screws.

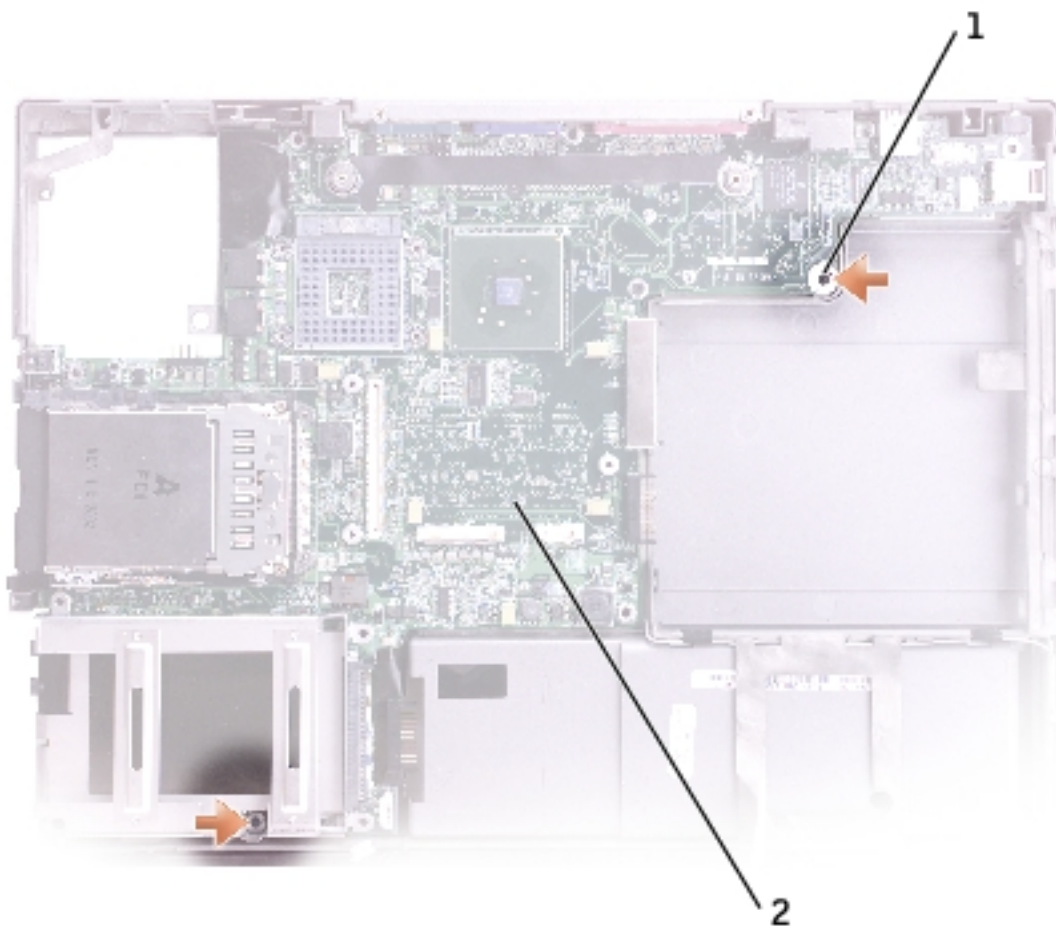

1	M2.5 x 4-mm screws (3)
2	system board

11. Remove the M2.5 x 12-mm screw labeled "circle B" from the computer base.

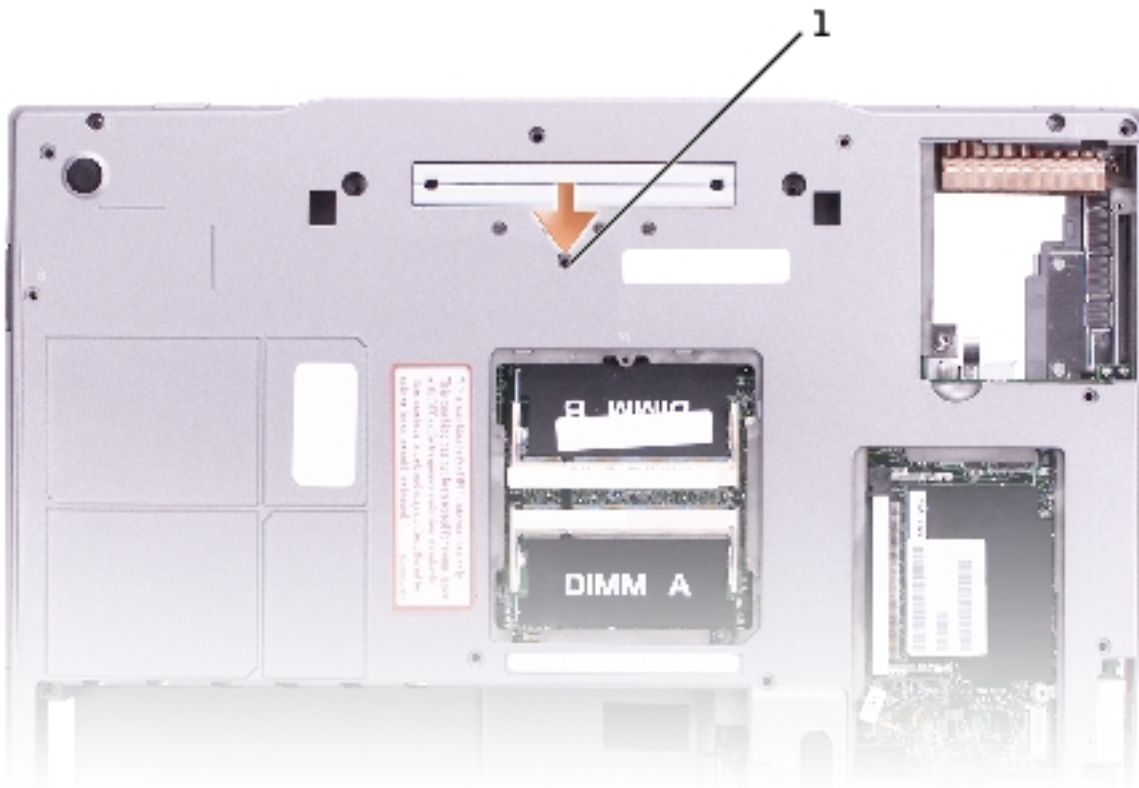

1	M2.5 x 12-mm screw (1)
---	------------------------

12. Remove the system board from the computer base.



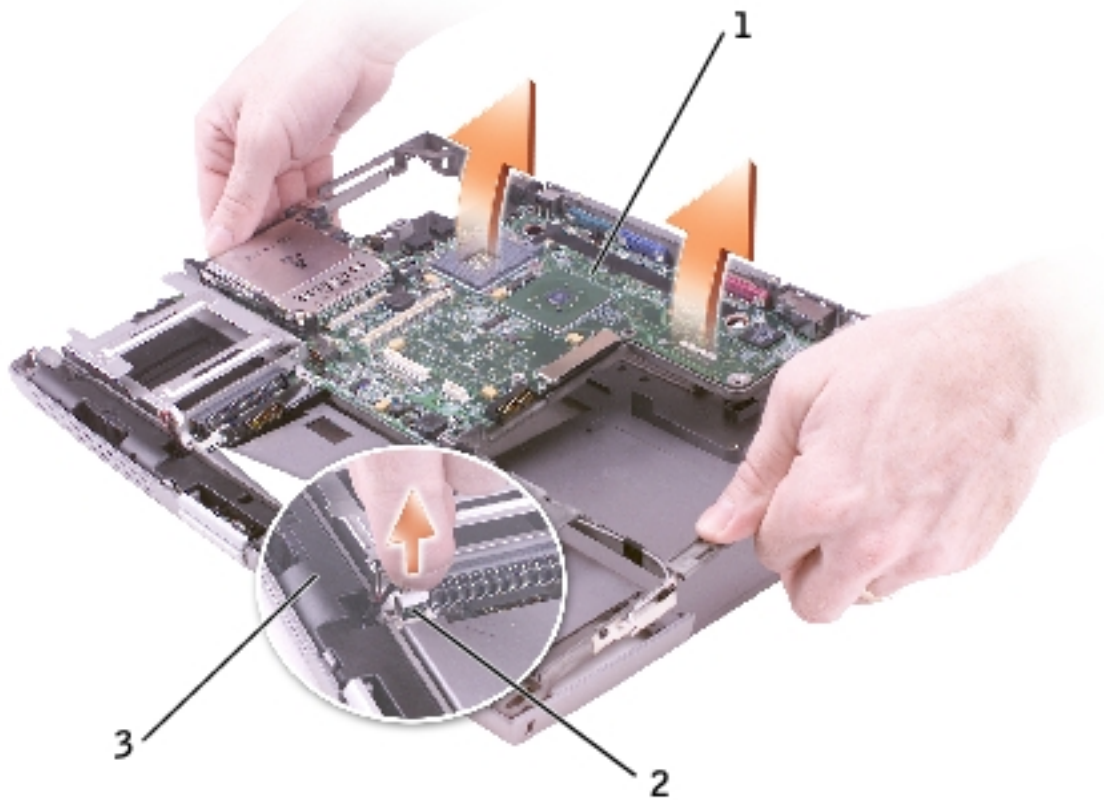

1	system board
2	speaker connector
3	speakers

## Installing the System Board

1. Perform all the steps in "[Removing the System Board](#)" in reverse order.



**NOTICE:** Before turning on the computer, replace all screws and ensure that no stray screws remain inside the computer. Failure to do so may result in damage to the computer.

2. Turn on the computer.



**NOTE:** After replacing the system board, enter the computer Service Tag into the BIOS of the replacement system board.

3. Insert the floppy disk or CD that accompanied the replacement system board into the appropriate drive. Follow the instructions that appear on the screen.

[Back to Contents Page](#)

[Back to Contents Page](#)

# Speakers

## Dell™ Inspiron™ 8500/8600 Service Manual



**CAUTION:** Before performing the following procedures, read the safety instructions in your *Owner's Manual*.



**NOTICE:** To avoid electrostatic discharge, ground yourself by using a wrist grounding strap or by periodically touching an unpainted metal surface (such as the back panel) on the computer.

1. Follow the instructions in "[Preparing to Work Inside the Computer](#)."
2. Remove the [keyboard](#).
3. Remove the [display assembly](#).
4. Remove the [palm rest](#).
5. Remove the [system board](#).



**NOTICE:** Handle the speakers with care to avoid damaging them.

6. Remove the M2.5 x 3-mm screw from the speakers.
7. Remove the [reserve battery](#) from the speakers, and lift out the speakers.

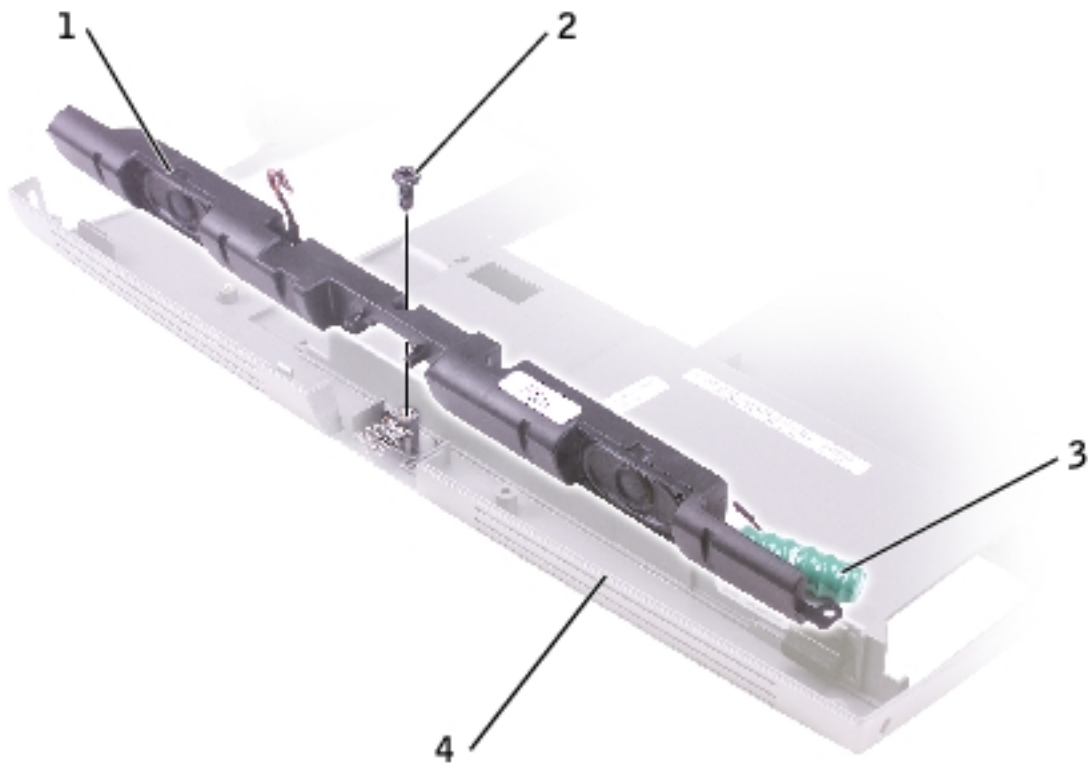

1	speakers
2	M2.5 x 3-mm screw (1)
3	reserve battery
4	computer base

---

[Back to Contents Page](#)

[Back to Contents Page](#)

# Base Latch

## Dell™ Inspiron™ 8500/8600 Service Manual



**CAUTION:** Before performing the following procedures, read the safety instructions in your *Owner's Manual*.



**NOTICE:** To avoid electrostatic discharge, ground yourself by using a wrist grounding strap or by periodically touching an unpainted metal surface (such as the back panel) on the computer.

1. Follow the instructions in "[Preparing to Work Inside the Computer](#)."
2. Remove the [hard drive](#).
3. Remove the [keyboard](#).
4. Remove the [display assembly](#).
5. Remove the [palm rest](#).
6. Remove the [system board](#).
7. Remove the [speakers](#).
8. Pull the base latch out and away from the computer base.

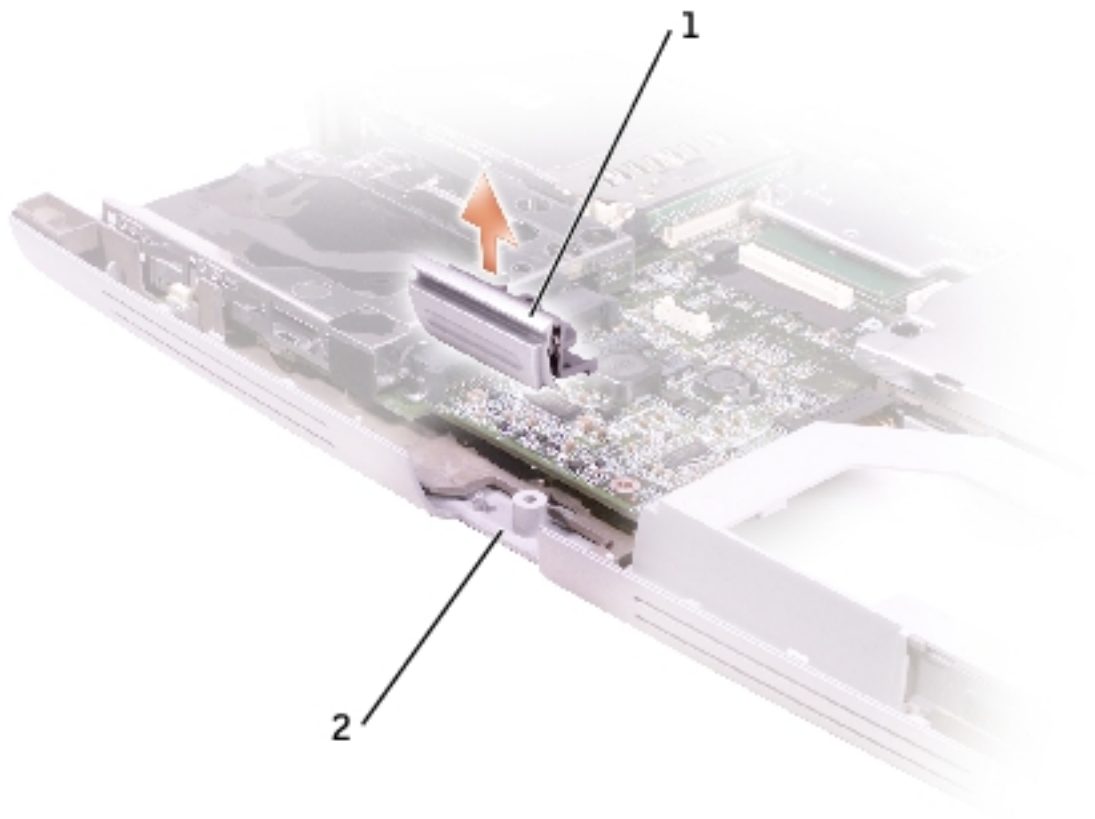

1	base latch
2	computer base

---

[Back to Contents Page](#)

[Back to Contents Page](#)

# Pin Assignments for I/O Connectors

## Dell™ Inspiron™ 8500/8600 Service Manual

- [USB Connector](#)
  - [Video Connector](#)
  - [Parallel Connector](#)
  - [S-Video TV-Out Connector](#)
  - [Serial Connector](#)
- 

## USB Connector



Pin	Signal
1	USB5V+
2	USBP-
3	USBP+
4	GND

---

## Video Connector



5 4 3 2 1  
10 9 8 7 6  
15 14 13 12 11

Pin	Signal	Pin	Signal
1	CRT_R	9	5V+
2	CRT_G	10	GND
3	CRT_B	11	MONITOR_DETECT-
4	NC	12	DDC_DATA
5	GND	13	CRT_HS
6	GND	14	CRT_VS
7	GND	15	DDC_CLK
8	GND		

## Parallel Connector



13 12 11 10 9 8 7 6 5 4 3 2 1  
25 24 23 22 21 20 19 18 17 16 15 14



Pin	Signal	Pin	Signal
1	STROBE-	10	ACK-
2	PD0	11	BUSY
3	PD1	12	PE
4	PD2	13	SLCT
5	PD3	14	AFD/3M-
6	PD4	15	ERROR-
7	PD5	16	INIT-
8	PD6	17	SLIN-
9	PD7	18-25	GND

## S-Video TV-Out Connector

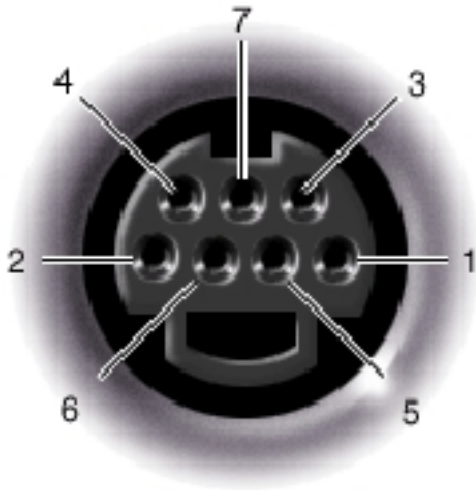

S-Video	
Pin	Signal
1	GND
2	GND

3	DLUMA-L
4	DCRMA-L

### Composite Video

Pin	Signal
5	SP_DIF
6	DCMPS-L
7	SP_DIF

## Serial Connector



Pin	Signal	Pin	Signal
1	DCD	6	DSR
2	RXDA	7	RTS
3	TXDA	8	CTS
4	DTR	9	RI
5	GND		

[Back to Contents Page](#)