

Thank you for purchasing this Factory Service Manual CD/DVD from [servicemanuals4u.com](http://servicemanuals4u.com).

Please check out our eBay auctions for more great deals on Factory Service Manuals:

[servicemanuals4u](http://servicemanuals4u.com)



Dell® Inspiron™ 7000

**REFERENCE AND  
TROUBLESHOOTING  
GUIDE**

---

**Information in this document is subject to change without notice.  
© 1994–1998 Dell Computer Corporation. All rights reserved.**

Reproduction in any manner whatsoever without the written permission of Dell Computer Corporation is strictly forbidden.

Trademarks used in this text: *Dell*, the *DELL* logo, *Optiplex*, and *Dell Dimension* are registered trademarks, *DellWare* is a registered service mark, and *Inspiron* is a trademark of Dell Computer Corporation; *Microsoft*, *MS-DOS*, and *Windows* are registered trademarks of Microsoft Corporation; *Intel* and *Pentium* are registered trademarks and *MMX* is a trademark of Intel Corporation.

Other trademarks and trade names may be used in this document to refer to either the entities claiming the marks and names or their products. Dell Computer Corporation disclaims any proprietary interest in trademarks and trade names other than its own.

July 1998 P/N 7286C



## **Safety Instructions**

Use the following safety guidelines to help protect your computer from potential damage and to help ensure your own personal safety.

### **When Using Your Computer**

As you use your computer, observe the following safety guidelines:

- Do not attempt to service the computer yourself. Always follow installation instructions closely.
- Do not carry a battery pack in your pocket, purse, or other container where metal objects (such as car keys) could short-circuit the battery terminals. The resulting excessive current flow can cause extremely high temperatures and may result in damage from burns.
- Be sure that nothing rests on your adapter's power cable and that the cable is not located where it can be tripped over or stepped on.
- Do not use your computer in a wet environment, for example, near a bath tub, sink, or swimming pool or in a wet basement.
- Use only the AC adapter and batteries that are approved for use with this computer as indicated in this document.
- If your computer includes an onboard or optional modem, disconnect the modem cable during an electrical storm to avoid the remote risk of electric shock from lightning.
- Do not dispose of battery packs in a fire. They may explode. Check with local authorities for disposal instructions.
- Before you clean your computer, turn it off, unplug it from its power source, and remove the battery pack(s).
- When setting up the computer for work, place it on a level surface.
- When traveling, do not check the computer as baggage. You can put your computer through an X-ray security machine, but *never* put your computer through a metal detector. If you have the computer checked by hand, be sure to have a charged battery available in case you are asked to turn on the computer.

- When traveling with the hard-disk drive removed from the computer, wrap the drive in a nonconducting material, such as cloth or paper. If you have the drive checked by hand, be ready to install the drive in the computer. You can put the hard-disk drive through an X-ray security machine, but *never* put the drive through a metal detector.
- When traveling, do not place the computer in overhead storage compartments where it could slide around. Do not drop your computer or subject it to other mechanical shocks.
- Protect your computer, battery, and hard-disk drive from environmental hazards such as dirt, dust, food, liquids, temperature extremes, and overexposure to sunlight.
- When you move your computer between environments with very different temperature and/or humidity ranges, condensation may form on or within the computer. To avoid damaging the computer, allow sufficient time for the moisture to evaporate before using the computer.



**CAUTION: When taking the computer from low-temperature conditions into a warmer environment or from high-temperature conditions into a cooler environment, allow the computer to acclimate to room temperature before turning on power.**

- When you disconnect a cable, pull on its connector or on its strain-relief loop, not on the cable itself. As you pull out the connector, keep it evenly aligned to avoid bending any connector pins. Also, before you connect a cable make sure both connectors are correctly oriented and aligned.
- Handle components with care. Hold a component such as a memory module by its edges, not its pins.
- When removing a memory module from the system board or disconnecting a peripheral device from the computer, wait 5 seconds after turning off the computer before removing the memory module or disconnecting the device to help avoid possible damage to the system board.
- Clean your computer with a soft cloth dampened with water rather than with liquid or aerosol cleaners.
- Clean the display with a soft, clean cloth and commercial window cleaner that does not contain wax or abrasives. Apply the cleaner to the cloth; then stroke the cloth across the display in one direction, moving from the top of the display to the bottom. If the display contains grease or some other contaminant, use isopropyl alcohol instead of commercial window cleaner.
- If your computer gets wet or is damaged, follow the procedures described in Chapter 3, "Troubleshooting Your Computer." If, after following these procedures, you confirm that your computer is not operating properly, contact Dell Computer Corporation. (See Chapter 5, "Getting Help," for the appropriate telephone number.)

# Ergonomic Computing Habits



**WARNING: Improper or prolonged keyboard use may result in injury.**

For comfort and efficiency, observe the following ergonomic guidelines when setting up and using your computer:

- Position your computer directly in front of you as you work.
- Adjust the tilt of the computer's display, its contrast and/or brightness settings, and the lighting around you (such as overhead lights, desk lamps, and the curtains or blinds on nearby windows) to minimize reflections and glare on the display.
- When using an external monitor with your computer, set the monitor at a comfortable viewing distance (usually 510 to 610 millimeters [20 to 24 inches] from your eyes). Make sure the monitor screen is at eye level or slightly lower when you are sitting in front of the monitor.
- Use a chair that provides good lower-back support.
- Keep your forearms horizontal with your wrists in a neutral, comfortable position while using the keyboard, trackball, touch pad, or external mouse.
- Always use the palmrest with the keyboard, touch pad, or trackball. Leave space to rest your hands when using an external mouse.
- Let your upper arms hang naturally at your sides.
- Sit erect with your feet resting on the floor and your thighs level.
- When sitting, make sure the weight of your legs is on your feet and not on the front of your chair seat. Adjust your chair's height or use a footrest, if necessary, to maintain proper posture.
- Vary your work activities. Try to organize your work so that you do not have to type for extended periods of time. When you stop typing, try to do things that use both hands.

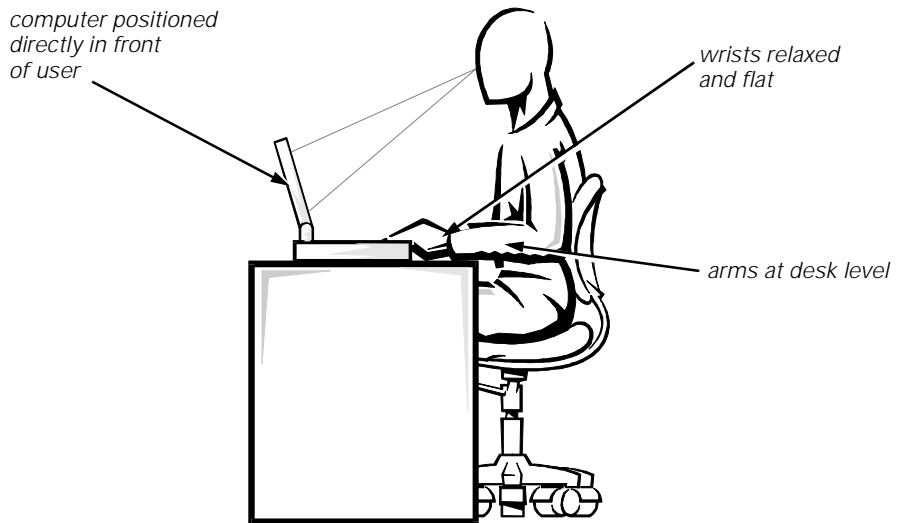

## **When Removing or Installing Memory Modules**

Before removing or installing memory modules, perform the following steps in the sequence indicated.



**CAUTION: The only time you should ever access the inside of your computer is when you are installing memory modules.**



**CAUTION: Wait 5 seconds after turning off the computer before disconnecting a peripheral device or removing a memory module to help prevent possible damage to the system board.**

1. Turn off your computer and any attached peripherals.
2. Disconnect your computer and peripherals from AC power to reduce the potential for personal injury or shock. Also, disconnect any telephone or telecommunication lines from the computer.
3. Remove the main battery from the battery compartment and, if necessary, the secondary battery from the options bay.
4. Ground yourself by touching the unpainted metal surface of the I/O panel on the back of the computer.

While you work, periodically touch the I/O panel to dissipate any static electricity that might harm internal components.

## ***Protecting Against Electrostatic Discharge***

Static electricity can harm electronic components inside your computer. To prevent static damage, discharge static electricity from your body before you touch any of your computer's electronic components, such as a memory module. You can do so by touching an unpainted metal surface on the computer's I/O panel.

As you continue to work inside the computer, periodically touch an I/O connector to remove any static charge your body may have accumulated.

You can also take the following steps to prevent damage from electrostatic discharge (ESD):

- When unpacking a static-sensitive component from its shipping carton, do not remove the component from the antistatic packing material until you are ready to install the component. Just before unwrapping the antistatic packaging, be sure to discharge static electricity from your body.
- When transporting a sensitive component, first place it in an antistatic container or packaging.
- Handle all sensitive components in a static-safe area. If possible, use antistatic floor pads and workbench pads.

The following caution may appear throughout this document to remind you of these precautions:



**CAUTION: See “Protecting Against Electrostatic Discharge” in the safety instructions at the front of this guide.**







# **Preface**

## **About This Guide**

This guide is intended for anyone who uses the Dell Inspiron 7000 portable computer. It can be used by both first-time and experienced computer users who want to learn about the features of the computer. This guide also provides basic troubleshooting procedures and instructions for using the Dell Diagnostics to test your computer and its components.

Summaries of the chapters and appendixes of this guide follow:

- Read Chapter 1, "Introduction," for an overview of the computer features and a list of available upgrades.
- Read Chapter 2, "Customizing System Features," to learn how to access the Setup program, which allows you to change system settings, such as your computer's power conservation features.
- Read Chapter 3, "Troubleshooting Your Computer," for some initial checks and procedures that can be used to solve basic computer problems and for some general guidelines on analyzing software problems. This chapter also discusses messages and beep codes.
- Read Chapter 4, "Running the Dell Diagnostics," for hardware-related problems. The Dell Diagnostics checks your computer's hardware and isolates component problems.
- Chapter 5, "Getting Help," describes the help tools Dell provides to assist you if you have a problem with the computer. It also explains how and when to call Dell for technical assistance.
- Appendix A, "Technical Specifications," is intended primarily as reference material if you are interested in learning more about the details of your computer.
- Appendix B, "Diagnostic Video Tests," provides samples of screens displayed when you run the Video Test Group of the Dell Diagnostics. These screens help you check a particular video function or group of functions on the built-in display or on an external monitor.

- Appendix C, “Regulatory Notices,” is for users who are interested in which regulatory agencies have tested and approved the Dell Inspiron 7000 portable computer.
- Appendix D, “Warranties and Return Policy,” describes the warranty and return policy for your Dell computer.

## **Warranty and Return Policy Information**

Dell Computer Corporation (“Dell”) manufactures its hardware products from parts and components that are new or equivalent to new in accordance with industry-standard practices.

For information about the Dell warranty and return policy, see Appendix D, “Warranties and Return Policy.”

## **Other Documents You May Need**

Besides this *Reference and Troubleshooting Guide*, the following online documentation is included with your computer:



The Windows-based *System User's Guide* contains essential information you need to use your portable computer. Look for the **Online Guide** icon on the desktop.



The *Dell Service and Support Policies* provides information about service and support policies, guarantees, and warranties (in the United States only). Look for the **Dell Services and Support Policies** icon in the **Dell Accessories** folder.

You may also have one or more of the following documents.



*NOTE: Documentation updates are sometimes included with your computer to describe changes to your computer or software. Always read these updates **before** consulting any other documentation because the updates contain the latest information.*

- The *Dell-Installed Microsoft Windows 98 Setup Guide*, which describes how to set up the Microsoft Windows 98 operating system on your Dell computer.
- Microsoft Windows 98 operating system documentation is included if you ordered your operating system from Dell. This documentation describes how to configure and use your operating system software.
- Documentation is included with any options you purchase separately from your computer. This documentation includes information that you need to configure and install these options in your Dell computer.
- “Readme” files may be installed on your hard-disk drive to provide last-minute updates about technical changes to your computer or advanced technical reference material intended for experienced users or technicians.

# Notational Conventions

The following subsections list notational conventions used in this document.

## Warnings, Cautions, and Notes

Throughout this guide, there may be blocks of text printed in color or in italic type. These blocks are warnings, cautions, and notes, and they are used as follows:



**WARNING:** A **WARNING** indicates the potential for bodily harm and tells you how to avoid the problem.



**CAUTION:** A **CAUTION** indicates either potential damage to hardware or loss of data and tells you how to avoid the problem.



*NOTE:* A *NOTE* indicates important information that helps you make better use of your computer.

## Typographical Conventions

The following list defines (where appropriate) and illustrates typographical conventions used as visual cues for specific elements of text throughout this document:

- *Interface components* are window titles, button and icon names, menu names and selections, and other options that appear on the monitor screen or display. They are presented in bold.  
Example: Click **OK**.
- *Keycaps*, the labeling that appears on the keys on a keyboard, are enclosed in angle brackets.  
Example: <Enter>
- *Key combinations* are series of keys to be pressed simultaneously (unless otherwise indicated) to perform a single function.  
Example: <Ctrl><Alt><Enter>
- *Commands* presented in lowercase bold are for reference purposes only and are not intended to be typed at that particular point in the discussion.  
Example: " Use the **setup** command to . . . ."  
  
In contrast, commands presented in the Courier New font are intended to be typed as part of an instruction.  
Example: " Type `format` to format the diskette in drive A."
- *Filenames* and *directory names* are presented in lowercase bold.  
Examples: **autoexec.bat** and **c:\windows**

- *Syntax lines* consist of a command and all its possible parameters. Commands are displayed in lowercase bold; variable parameters (those for which you substitute a value) are displayed in lowercase italics; constant parameters are displayed in lowercase bold. The brackets indicate items that are optional.

Example: **del** [*drive:*] [*[path]filename*] [**/p**]

- *Command lines* consist of a command and may include one or more of the command's possible parameters. Command lines are presented in the Courier New font.

Example: `del c:\myfile.doc`

- *Screen text* is text that appears on the screen of your display or external monitor. It can be a system message, for example, or it can be text that you are instructed to type as part of a command (referred to as a *command line*). Screen text is presented in the Courier New font.

Example: The following message appears on your screen:

`No boot device available`

- *Variables* are symbols for which you substitute a value. They are presented in italics.

Example: module *n* (where *n* represents the memory module number)



# Contents

<b>Chapter 1</b>	<b>Introduction . . . . .</b>	<b>1-1</b>
	Hardware Features . . . . .	1-3
	Software Features . . . . .	1-5
	Using the Power Button . . . . .	1-5
	Accessing Electronic Documentation . . . . .	1-6
	Available Options . . . . .	1-6
	Getting Help . . . . .	1-7
<b>Chapter 2</b>	<b>Customizing System Features . . . . .</b>	<b>2-1</b>
	System Utilities . . . . .	2-1
	Setup Program . . . . .	2-2
	Accessing the Setup Program . . . . .	2-3
	Main Menu Options . . . . .	2-3
	System Time . . . . .	2-4
	System Date . . . . .	2-4
	Floppy Drive . . . . .	2-4
	Hard Disk . . . . .	2-4
	Quiet Boot . . . . .	2-4
	Video Display Device . . . . .	2-4
	Television Type . . . . .	2-4
	System Memory . . . . .	2-4
	Extended Memory . . . . .	2-5
	System Devices Menu Options . . . . .	2-5
	IDE Controller . . . . .	2-5
	FDD Controller . . . . .	2-6
	Internal MPEG II . . . . .	2-6
	Serial Port . . . . .	2-6
	Infrared Port . . . . .	2-6
	Parallel Port . . . . .	2-6

Security Menu Options . . . . .	2-7
System Password . . . . .	2-7
Set System Password . . . . .	2-7
Password on Boot . . . . .	2-8
Power Menu Options . . . . .	2-8
Power Management Mode . . . . .	2-8
Smart CPU Mode . . . . .	2-9
Standby Time-Out . . . . .	2-9
Suspend Time-Out . . . . .	2-10
Suspend Mode . . . . .	2-10
Resume on Modem Ring . . . . .	2-11
Resume on Time of Day . . . . .	2-11
Resume Time . . . . .	2-11
Boot Menu Options . . . . .	2-11
Exit Menu Options . . . . .	2-12
Save Changes and Exit . . . . .	2-13
Discard Changes and Exit . . . . .	2-13
Get Default Values . . . . .	2-13
Load Previous Values . . . . .	2-13
Save Changes . . . . .	2-14
Reinstalling Utilities and Drivers . . . . .	2-14
Reinstalling Video Drivers . . . . .	2-14
Reinstalling Touch Pad Drivers . . . . .	2-15
Reinstalling Audio Drivers . . . . .	2-15
Reinstalling Internal Modem Drivers . . . . .	2-15
Reinstalling DVD-ROM Decoder Drivers . . . . .	2-16
Creating the Save-to-Disk Suspend File . . . . .	2-16
Reinstalling the System User's Guide . . . . .	2-17

## **Chapter 3      *Troubleshooting Your Computer* . . . . . 3-1**

Backing Up Your Files . . . . .	3-1
Basic Checks . . . . .	3-2
Checking Connections . . . . .	3-3
Look and Listen . . . . .	3-5
Setup Options . . . . .	3-6
Messages and Codes . . . . .	3-6
System Beep Codes . . . . .	3-8
Finding Software Solutions . . . . .	3-10
Installing and Configuring Software . . . . .	3-10
Start-Up Files . . . . .	3-11
Using Software . . . . .	3-11
Error Messages . . . . .	3-11

Input Errors . . . . .	3-11
Memory-Resident Programs . . . . .	3-11
Program Conflicts . . . . .	3-12
Avoiding Interrupt Assignment Conflicts . . . . .	3-12
Troubleshooting Procedures . . . . .	3-13
Troubleshooting a Wet Computer . . . . .	3-13
Troubleshooting a Damaged Computer . . . . .	3-15
Troubleshooting a Power Failure . . . . .	3-16
Total Power Failure When Using the AC Adapter . . . . .	3-17
Total Power Failure When Using a Battery . . . . .	3-18
No Power to a Part of the Computer . . . . .	3-19
Troubleshooting the Diskette Drive . . . . .	3-20
Troubleshooting the CD-ROM or DVD-ROM Drive . . . . .	3-21
Troubleshooting the Hard-Disk Drive . . . . .	3-22
Troubleshooting an External Keyboard . . . . .	3-23
Troubleshooting Memory . . . . .	3-25
Troubleshooting the Display . . . . .	3-27
Troubleshooting an External Monitor . . . . .	3-28
Troubleshooting the Serial and Parallel Ports . . . . .	3-29
Troubleshooting the Basic I/O Functions . . . . .	3-30
Troubleshooting a Parallel Printer . . . . .	3-31
Troubleshooting a Serial I/O Device . . . . .	3-32
Troubleshooting the Infrared Port . . . . .	3-33
Troubleshooting the Touch Pad . . . . .	3-33
Troubleshooting Audio Functions . . . . .	3-34

**Chapter 4      *Running the Dell Diagnostics . . . . . 4-1***

Features of the Dell Diagnostics . . . . .	4-1
When to Use the Dell Diagnostics . . . . .	4-2
Before You Start Testing . . . . .	4-2
Starting the Dell Diagnostics . . . . .	4-3
Completing the Dell Diagnostics . . . . .	4-4
How to Use the Dell Diagnostics . . . . .	4-4
Confirming the System Configuration Information . . . . .	4-5
How to Use the Menu . . . . .	4-6
Main Menu Options . . . . .	4-6
Run . . . . .	4-6
Select . . . . .	4-7
Subtest . . . . .	4-7
Run (Under Subtest) . . . . .	4-7
Select (Under Subtest) . . . . .	4-7
Options (Under Subtest) . . . . .	4-8



Test Limits (Under Subtest) . . . . .	4-8
About (Under Subtest) . . . . .	4-8
Key-Help (Under Subtest) . . . . .	4-8
Quit Menu (Under Subtest) . . . . .	4-8
Options . . . . .	4-8
Number of Times to Repeat Test(s) . . . . .	4-9
Maximum Errors Allowed . . . . .	4-9
Pause for User Response . . . . .	4-9
Output Device for Status Messages . . . . .	4-10
Output Device for Error Messages . . . . .	4-11
Test Limits . . . . .	4-11
About . . . . .	4-11
Key-Help . . . . .	4-12
Quit . . . . .	4-12
Tests in the Dell Diagnostics . . . . .	4-12
Error Messages . . . . .	4-14
RAM Test Group . . . . .	4-14
Why Run a RAM Test? . . . . .	4-14
Subtests . . . . .	4-15
System Set Test Group . . . . .	4-15
Why Run a System Set Test? . . . . .	4-15
Subtests . . . . .	4-16
Video Test Group . . . . .	4-17
Why Run a Video Test? . . . . .	4-18
Subtests . . . . .	4-18
Keyboard Test Group . . . . .	4-19
Why Run a Keyboard Test? . . . . .	4-19
Subtests . . . . .	4-20
Mouse Test . . . . .	4-20
Why Run the Mouse Test? . . . . .	4-20
Subtests . . . . .	4-20
Diskette Drives Test Group . . . . .	4-21
Why Run a Diskette Drives Test? . . . . .	4-21
Subtests . . . . .	4-21
IDE (ATA/ATAPI) Devices Test Group . . . . .	4-22
Why Run an IDE Devices Test? . . . . .	4-22
Subtests . . . . .	4-22
Serial/Infrared Ports Test Group . . . . .	4-23
Why Run a Serial/Infrared Ports Test? . . . . .	4-23
Subtests . . . . .	4-24
Parallel Ports Test Group . . . . .	4-24
Why Run a Parallel Ports Test? . . . . .	4-24
Subtests . . . . .	4-25

Audio Test Group . . . . .	4-26
Why Run an Audio Test? . . . . .	4-26
Subtests . . . . .	4-26

**Chapter 5      Getting Help . . . . . 5-1**

Technical Assistance . . . . .	5-1
Help Tools . . . . .	5-2
System User's Guide . . . . .	5-2
World Wide Web on the Internet . . . . .	5-2
AutoTech Service . . . . .	5-3
TechFax Service . . . . .	5-3
TechConnect BBS . . . . .	5-4
Automated Order-Status System . . . . .	5-4
Technical Support Service . . . . .	5-4
Problems With Your Order . . . . .	5-4
Product Information . . . . .	5-4
Returning Items for Warranty Repair or Credit . . . . .	5-5
Before You Call . . . . .	5-5
Dell Contact Numbers . . . . .	5-7

**Appendix A      Technical Specifications . . . . . A-1**

**Appendix B      Diagnostic Video Tests . . . . . B-1**

Video Memory Test . . . . .	B-2
Video Hardware Test . . . . .	B-2
Text Mode Character Test . . . . .	B-2
Character Attributes Subtest (80 x 25) . . . . .	B-2
Character Set Subtest (80 x 25) . . . . .	B-2
Character Attributes Subtest (40 x 25) . . . . .	B-3
Character Set Subtest (40 x 25) . . . . .	B-3
Text Mode Color Test . . . . .	B-4
Color Attributes Subtest (80 x 25) . . . . .	B-4
Color Attributes Subtest (40 x 25) . . . . .	B-5
Color Bars Subtest . . . . .	B-5
Text Mode Pages Test . . . . .	B-5
Graphics Mode Test . . . . .	B-5
320 x 200 Graphics Mode Screens . . . . .	B-5
320 x 200 16-Color Graphics Mode Screen . . . . .	B-5
640 x 200 16-Color Graphics Mode Screen . . . . .	B-6
640 x 350 16-Color Graphics Mode Screen . . . . .	B-6
640 x 480 2-Color Graphics Mode Screen . . . . .	B-6
640 x 480 16-Color Graphics Mode Screen . . . . .	B-6

320 x 200 256-Color Graphics Mode Screen . . . . .	B-7
640 x 480 256-Color Graphics Mode Screen . . . . .	B-7
800 x 600 16-Color Graphics Mode Screen . . . . .	B-7
800 x 600 256-Color Graphics Mode Screen . . . . .	B-7
1024 x 768 16-Color Graphics Mode Screen . . . . .	B-7
1024 x 768 256-Color Graphics Mode Screen . . . . .	B-7
Color Palettes Test . . . . .	B-7
Solid Colors Test . . . . .	B-8

**Appendix C      *Regulatory Notices* . . . . . C-1**

FCC Notices (U.S. Only) . . . . .	C-2
Class A . . . . .	C-3
Class B . . . . .	C-3
Modem Regulatory Information . . . . .	C-3
Fax Branding . . . . .	C-4
IC Notice (Canada Only) . . . . .	C-5
Modem Regulatory Information . . . . .	C-5
CE Notice (European Union) . . . . .	C-6
EN 55022 Compliance (Czech Republic Only) . . . . .	C-7
VCCI Notice (Japan Only) . . . . .	C-7
Class A ITE . . . . .	C-7
Class B ITE . . . . .	C-8
MOC Notice (South Korea Only) . . . . .	C-8
Class A Device . . . . .	C-8
Class B Device . . . . .	C-9
Polish Center for Testing and Certification Notice . . . . .	C-9
Wymagania Polskiego Centrum Badań i Certyfikacji . . . . .	C-10
Pozostałe instrukcje bezpieczeństwa . . . . .	C-10
NOM Information (Mexico Only) . . . . .	C-11
Información para NOM (únicamente para México) . . . . .	C-12
BCIQ Notice (Taiwan Only) . . . . .	C-12

**Appendix D      *Warranty, Return Policy, and Year 2000 Statement of Compliance* . . . . . D-1**

Limited Three-Year Warranty (U.S. and Canada Only) . . . . .	D-1
Coverage During Year One . . . . .	D-1
Coverage During Years Two and Three . . . . .	D-2
General Provisions . . . . .	D-2
“Total Satisfaction” Return Policy (U.S. and Canada Only) . . . . .	D-3

Year 2000 Statement of Compliance for Dell-Branded Hardware Products . . . . .	D-4
Previous Products . . . . .	D-4
Software . . . . .	D-5
Additional Information . . . . .	D-5

## **Index**

### **Figures**

Figure 1-1. Front View of the Portable Computer . . . . .	1-2
Figure 1-2. Back View of the Portable Computer. . . . .	1-3
Figure 2-1. Main Menu of Setup Program . . . . .	2-3
Figure 2-2. System Devices Menu of Setup Program . . . . .	2-5
Figure 2-3. Security Menu of Setup Program . . . . .	2-7
Figure 2-4. Power Menu of Setup Program . . . . .	2-8
Figure 2-5. Boot Menu of Setup Program . . . . .	2-12
Figure 2-6. Exit Menu of Setup Program . . . . .	2-13
Figure 3-1. AC Adapter and Power Cable . . . . .	3-3
Figure 3-2. Checking the Battery . . . . .	3-3
Figure 3-3. Checking an Optional Device. . . . .	3-4
Figure 3-4. I/O Panel Connectors for External Devices . . . . .	3-4
Figure 3-5. Removing the Memory Module Cover . . . . .	3-14
Figure 3-6. Removing the Memory Module Cover . . . . .	3-16
Figure 3-7. Removing the Memory Module Cover . . . . .	3-25
Figure 3-8. Removing a Memory Module . . . . .	3-26
Figure 3-9. Installing a Memory Module . . . . .	3-26
Figure 4-1. Diagnostics Menu . . . . .	4-3
Figure 4-2. Main Screen of the Dell Diagnostics . . . . .	4-5
Figure 5-1. Diagnostics Checklist. . . . .	5-6
Figure B-1. 80-Column x 25-Line Character Set Subtest Screen . . . . .	B-3
Figure B-2. 40-Column x 25-Line Character Set Subtest Screen . . . . .	B-3
Figure B-3. 640 x 480 2-Color Graphics Mode Screen . . . . .	B-6
Figure C-1. VCCI Class A ITE Regulatory Mark . . . . .	C-7
Figure C-2. VCCI Class B ITE Regulatory Mark . . . . .	C-8
Figure C-3. MOC Class A Regulatory Mark . . . . .	C-9
Figure C-4. MOC Class B Regulatory Mark . . . . .	C-9

## **Tables**

Table 3-1.	Boot Routine Indications . . . . .	3-5
Table 3-2.	System Error Messages . . . . .	3-6
Table 3-3.	Beep Codes . . . . .	3-9
Table 3-4.	IRQ Line Assignments. . . . .	3-12
Table 4-1.	Option Parameters . . . . .	4-9
Table 4-2.	Dell Diagnostics Tests. . . . .	4-13
Table 5-1.	International Dialing Codes . . . . .	5-8
Table 5-2.	Dell Contact Numbers . . . . .	5-9
Table A-1.	Technical Specifications . . . . .	A-1
Table B-1.	Color Attributes . . . . .	B-4



# **CHAPTER 1**

## ***Introduction***

The Dell® Inspiron™ 7000 is an expandable, multimedia portable computer designed around the Intel® Pentium® microprocessor with MMX™ technology and Peripheral Component Interconnect (PCI) technology. This chapter describes the major hardware and software features of your computer, provides information about accessing the online documentation, and tells you where to find help when needed.

Figures 1-1 and 1-2 show the front and back views of the portable computer.

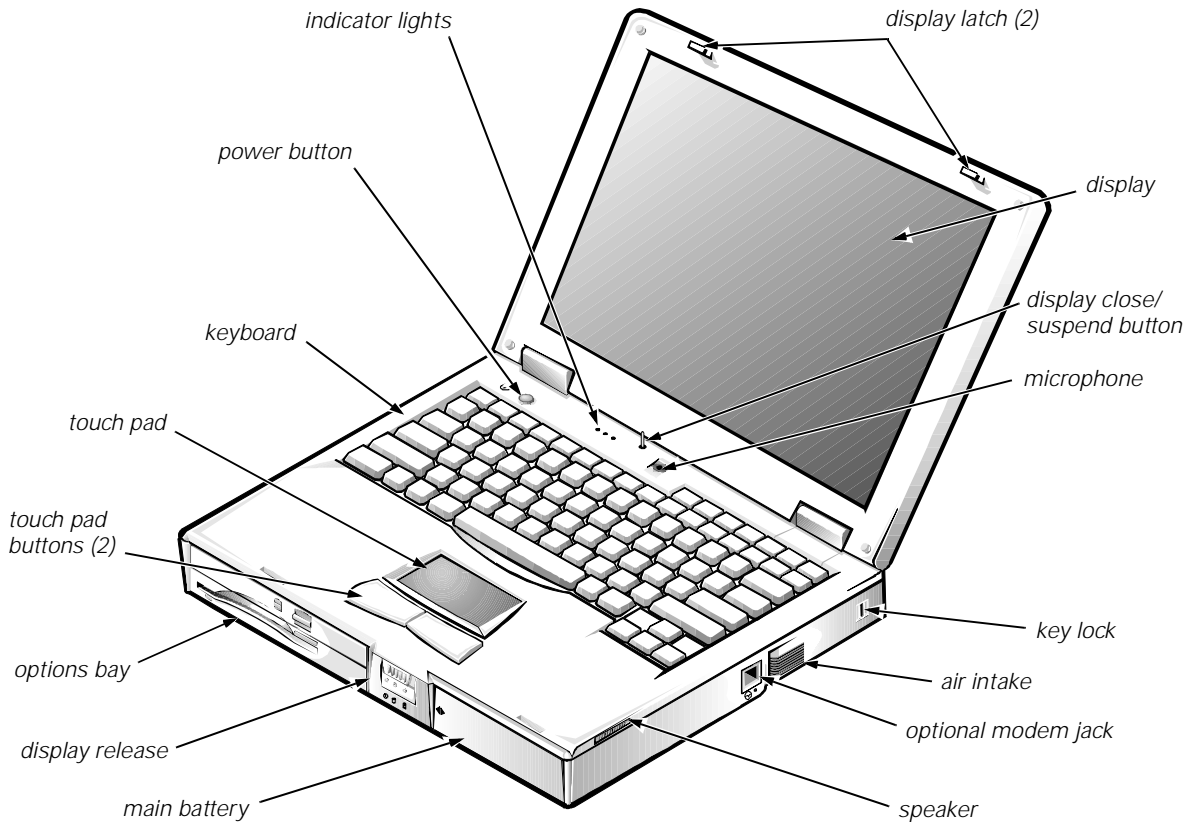

**Figure 1-1. Front View of the Portable Computer**

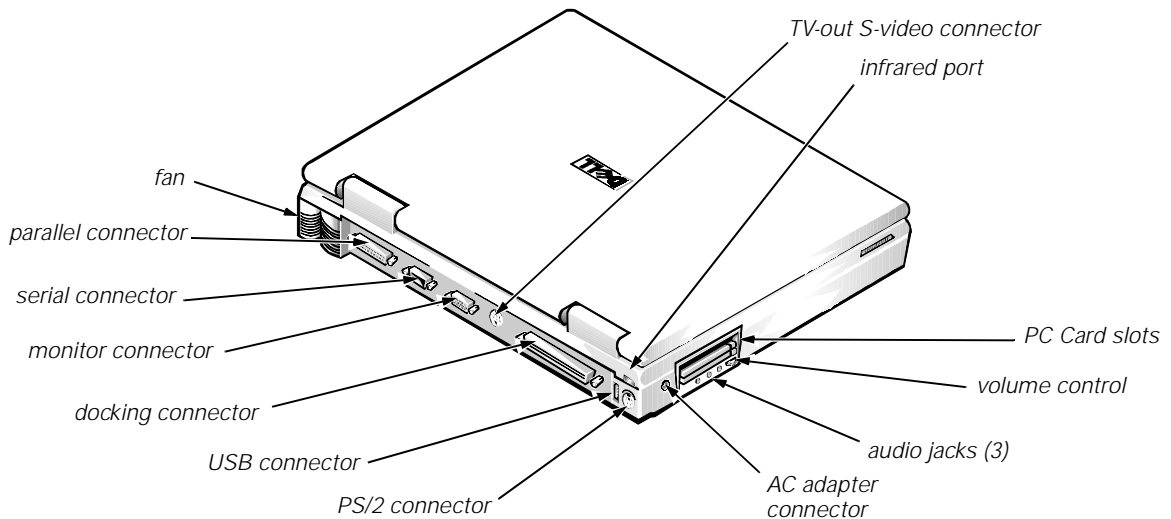

**Figure 1-2. Back View of the Portable Computer**

## Hardware Features

Your Dell computer has the following features:

- An Intel Pentium microprocessor with MMX technology running at 266 or 300 megahertz (MHz).
- Full multimedia capability through the following standard features:
  - A combination module that includes a CD-ROM or digital versatile disc (DVD)-ROM drive and a diskette drive that you can use in the options bay.
  - Built-in microphone and stereo speakers.
  - Jacks for connecting external speakers, headphones, or a microphone to your computer.
  - S-Video TV-out connector for TV-out that you can use with any device with a S-Video port.
  - Composite TV-out adaptor cable that allow you to use a television with the computer.
  - An ATI video controller with an accelerated graphics port (AGP 2X), 4 or 8 megabytes (MB) of video memory, 3D assist, Moving Pictures Experts Group (MPEG)-2 assist, and flicker-free TV-out.
- A 13.3- or 14.1-inch active-matrix extended graphics array (XGA) color display.



- Extended battery power with a lithium ion main battery and an optional secondary battery that can be used in the options bay to double battery life.

The battery charges in approximately 2 hours, using an alternating current (AC) power source, if the computer is off; the battery charges in approximately 2.5 hours if the computer is on. You can expect 2.5 to 3.5 hours of battery life with a single battery, and 5 to 7 hours of battery life with two batteries.



*NOTES: Battery performance features such as charge time, operating time, and life span can vary according to the conditions under which the computer and battery are used.*

*The battery is designed to work only with Dell Inspiron 7000 computers. Do not attempt to use the battery with other computers.*



**WARNING: Do not puncture or incinerate the battery. When your battery no longer holds a charge, call your local waste disposal agency or environmental agency for advice on disposing of the computer's lithium ion battery. The lithium ion technology used in the battery is significantly less hazardous to the environment than the lithium metal technology used in some other batteries (such as watch batteries).**

- Cache memory that enhances the speed of many microprocessor operations by storing the most recently accessed contents of system memory. Dell Inspiron 7000 computers have 32 kilobytes (KB) of internal cache on the microprocessor and 512 KB of static random-access memory (SRAM) level 2 (L2) cache.
- Thirty-two or 64 MB of nonremovable memory on the system board. Memory on any Dell Inspiron 7000 system can be increased up to 192 MB by installing a combination of 32- or 64-MB 3.3-volt (V) small-outline, dual in-line memory modules (SODIMMs) in the two memory module sockets on the system board.
- The power conservation mode *save-to-disk suspend mode*, which helps you conserve battery power. If the batteries run out of power, save-to-disk suspend mode prevents data loss by copying all system data to the hard-disk drive and turning off the computer.
- A special options bay and a variety of combination modules that extend the functionality of your computer. You can select a CD-ROM drive and diskette drive module, a DVD-ROM drive and diskette module, or you can use the options bay for an optional second battery.
- Sixteen-bit stereo with hardware wavetable, 3D surround sound, and integrated speakers and microphone.
- Support for up to two 3.3-V or 5-V PC Cards. The computer supports up to two type I or type II cards (in any combination) or one type III card. Dell-installed device drivers on the hard-disk drive support the operation of many standard PC Cards.
- A basic input/output system (BIOS) that resides in flash memory and can be upgraded by diskette. A BIOS upgrade, if required, can be obtained on diskette from Dell or can be downloaded from Dell's TechConnect BBS. See Chapter 5, "Getting Help," for more information on Dell's online services.

- High-performance parallel and serial ports, and a multipurpose Personal System (PS)/2 connector for attaching external devices. There is also a monitor connector for attaching an external monitor to your computer.
- A PS/2-compatible touch pad that gives your computer full mouse functionality.
- An infrared port for use with compatible external devices. The infrared port permits file transfers without using cable connections. Fast infrared technology is also available.
- Universal Serial Bus (USB) capability, which can simplify connecting peripheral devices such as mice, printers, and computer speakers. The USB connector on your computer's back panel provides a single connection point for multiple USB-compliant devices. USB-compliant devices can also be connected and disconnected while the system is running.
- The Ultra DMA/33 data transfer protocol for the advanced technology attachment (ATA)/integrated drive electronics (IDE) hard-disk drive interface. Ultra DMA/33 allows for data transfer rates of up to 33 MB/sec.

## Software Features

Dell has installed the Microsoft® Windows® 98 operating system on your hard-disk drive. The following software is also included with your Dell computer:

- A Setup program and system utilities that let you customize the operation of your computer. Also included are drivers that tell your computer how to communicate with various types of hardware, such as printers and external monitors. For more information, see Chapter 2, "Customizing System Features," and the "Software Features" section of the *System User's Guide*.



*NOTE: The system utilities and drivers are available separately on diskette from Dell for customers who installed their own version of Windows 98. See Chapter 5, "Getting Help," for the appropriate contact information in your location.*

- The Dell Diagnostics for evaluating your computer's components and devices. For more information, see Chapter 4, "Running the Dell Diagnostics."

After you turn on your computer the first time, accept the software licenses agreement. Then complete the installation of your operating system.

## Using the Power Button

Under normal circumstances, you should only use the power button to turn on the computer or to resume from suspend mode. To shut down the computer, click the **Start** button in Windows 98, and then click **Shut Down**.

If the computer locks up and the operating system does not respond, press and hold the power button until the system turns off completely (this may take several seconds).

# Accessing Electronic Documentation

The *Dell Inspiron 7000 System User's Guide* installed on your hard-disk drive contains information on the following topics:

- System features
- Traveling with the computer
- Customizing system configuration
- Powering the computer and extending battery life
- Connecting external devices
- Maintaining the system
- Contacting Dell

The guide also contains a glossary of commonly used computer terms and abbreviations.



To access this guide, select the **Online Guide** icon on the desktop.

To print any screen from the *System User's Guide*, display the screen you want, and select **Print Topic** from the **File** menu.

## Available Options

Dell offers the following devices and upgrade options:

- Internal 56-KB digital simultaneous voice and data (DSVD) telephony modem
- Internal MPEG-2/DVD decode card
- DVD-ROM drive and diskette drive combination module
- External devices, such as pointing devices, printers, external monitors, external keyboards, and numeric keypads, that connect to ports on the back of the computer
- AC adapter
- Lithium ion battery pack
- Hard-disk drives
- Network PC Cards
- Dell Inspiron 7000 Port Replicator
- Memory modules (32- and 64-MB capacities, 128-MB when available)
- Leather and nylon carrying cases
- Auto adapter
- Microphone
- External speakers
- Headphones

Instructions for connecting or installing these options are contained in the *System User's Guide* or are included in the upgrade kit you received from Dell.

## **Getting Help**

If at any time you don't understand a procedure described in this guide, or if your computer does not perform as expected, Dell provides a number of tools to help you. For more information, see Chapter 5, "Getting Help."





## CHAPTER 2

# Customizing System Features

As your computing environment changes, you may want to customize the configuration of your computer. The system utilities and the Setup program let you control various hardware and software features of your computer and allow you to monitor and reduce power consumption when your computer is running on battery power. This chapter explains how to access and use the system utilities and the Setup program.

### System Utilities

If Dell installed your operating system, the system utilities are on the hard-disk drive that came with the computer.



*NOTE: The system utilities are available separately on diskettes for those who installed their own version of the Microsoft Windows 98 operating system. To order these diskettes from Dell, see Chapter 5, "Getting Help," for the appropriate telephone number in your location.*

Use system utilities to:

- Configure PC Cards

If you are using Windows 98, use the PC Card utility that comes with the operating system. Click the **Start** button, point to **Settings**, and click **Control Panel**. Double-click the **PC Card** (PCMCIA) icon.

For more information, see the topic titled "Configuring PC Cards" in the *System User's Guide*.

- Change video resolution

In Windows 98, click the **Start** button, point to **Settings**, and click **Control Panel**. Double-click the **Display** icon and click the **Settings** tab. To change other video settings, such as the refresh rate or external monitor settings, click **Advanced**.

For more information, see the topic titled "Adjusting Video Resolution and Refresh Rate" in the *System User's Guide*.

- Adjust audio properties

In Windows 98, click the **Start** button, point to **Settings**, and then click **Control Panel**. Double-click the **Multimedia** icon. Alternatively, right-click the **Audio** icon in the taskbar.

- Customize touch pad and cursor features

In Windows 98, click the **Start** button, point to **Settings**, and then click **Control Panel**. Double-click the **Mouse** icon.

For more information, see the topic titled “Touch Pad” in the *System User's Guide*.

- Check battery status

In Windows 98, see the operating system documentation for instructions on using the battery status utility that comes with the operating system.

- Manage power consumption when using a battery

For more information about saving battery power, see the topic titled “Conserving Battery Power” in the *System User's Guide*.

## Setup Program

Your computer retains system configuration information in the nonvolatile random-access memory (NVRAM) maintained by your computer's backup battery. Each time you turn on your computer, the system compares the installed hardware with the system configuration information stored in NVRAM. If the system detects a discrepancy, it generates an error message that identifies the incorrect configuration setting. The system then prompts you to enter the Setup program to correct the setting.

You can use the Setup program as follows:

- To set or change user-selectable features — for example, power management or security features
- To verify information about your computer's current configuration, such as the amount of system memory
- To change your system configuration information after you add, change, or remove hardware connected to or installed inside your computer

## Accessing the Setup Program



**CAUTION: To avoid data loss, exit any application programs before rebooting the computer to enter the Setup program.**

To access the Setup program, press <F2> when prompted during start-up. The computer reboots automatically when you exit the Setup program.

The **Main** menu of the Setup program shows how the computer is configured. In addition to the **Main** menu (see Figure 2-1), you can also access the **System Devices** menu, **Security** menu, **Power** menu, **Boot** menu, and **Exit** menu.



*NOTE: When you press <F9>, the computer resets the default values for each option in that menu. When you press <F10>, the computer saves the current values and exits the Setup program.*

## Main Menu Options

The following subsections explain each option in the **Main** menu (see Figure 2-1) of the Setup program. The same information is also available in the topic titled "Main Menu" in the *System User's Guide*.

PhoenixBIOS Setup Utility			
Main	System Devices	Security	Power Boot Exit
System Time:	[03:06:18]	Item Specific Help	
System Date:	[08/15/1998]		
Floppy Drive:	1.44 MB, 3 1/2"		
Hard Disk:	4100 MB		
Quiet Boot:	[Enabled]		
Video Display Device:	[Simul Mode]		
Television Type:	[Disabled]		
System Memory:	640 KB		
Extended Memory:	32 MB		
Visit our Web site at <a href="http://www.dell.com/">http://www.dell.com/</a>			
F1 Help	↑↓ Select Item	F5/F6 Change Values	F9 Setup Defaults
ESC Exit	← Select Menu	Enter Select % Sub-Menu	F10 Save and Exit

**Figure 2-1. Main Menu of Setup Program**



### *System Time*

**System Time** sets the computer to the time you specify (usually the current time). Type in the appropriate information. Use the tab key to move between the hours, minutes, and seconds fields. This option is useful if you travel between time zones.

### *System Date*

**System Date** sets your system to the date you specify (usually the current date). Type in the appropriate information. Use the tab key to move between the month, day, and year fields.

### *Floppy Drive*

**Floppy Drive** identifies the type of diskette drive being used by the computer. This option has no user-selectable settings.

**1.44 MB, 3 1/2"** means there is a diskette drive in the options bay.

**Not installed** means that there is no diskette drive installed.

### *Hard Disk*

Displays the capacity of the computer's hard-disk drive. If you install a drive with a different capacity, the settings under this option change automatically. This option does not have any user-selectable settings.

### *Quiet Boot*

When set to **Enabled** (the default), the diagnostic power-on self-test (POST) messages and summary screen do not appear at system boot. **Disabled** indicates that the POST messages and summary screen do appear at system boot. In addition, if **Quiet Boot** is enabled, you cannot choose a boot device as the system initializes.

### *Video Display Device*

Allows you to specify whether video is visible only on the computer's display (**LCD Mode**), only on an external monitor or projector (**CRT Mode**), or on both the display and an external device simultaneously (**Simul Mode**, the default).

When you are using Windows 98 (rather than the Setup program), press <Fn><F8> to change the video display device.

### *Television Type*

This option allows you to specify that a television is connected on the TV port. The options are **Disabled** (the default), **NTSC**, and **PAL**.

### *System Memory*

**System Memory** displays the base amount of dynamic random-access memory (DRAM) installed in the computer. Each computer has 640 kilobytes (KB) of base memory. This option has no user-selectable settings.

## Extended Memory

**Extended Memory** displays the total amount of memory above 1 megabyte (MB). Each computer comes standard with at least 32 MB of memory on the system board. If you install or remove memory, the amount of extended memory displayed changes. This option has no user-selectable settings.

## System Devices Menu Options

The following subsections explain each option in the **System Devices** menu of the Setup program (see Figure 2-2). The same information is also available in the topic titled "System Devices Menu" in the *System User's Guide*.

PhoenixBIOS Setup Utility			
Main	<b>System Devices</b>	Security	Power
		Boot	Exit
IDE Controller	[Both]		Item Specific Help
FDD Controller	[Enabled]		
Internal MPEG II	[Enabled]		
Serial Port	[Auto]		
Infrared Port	[Disabled]		
Parallel Port: Mode	[Auto] [ECP]		

F1 Help    ↑↓ Select Item    F5/F6 Change Values    F9 Setup Defaults  
ESC Exit    ↔ Select Menu    Enter Select % Sub-Menu    F10 Save and Exit

**Figure 2-2. System Devices Menu of Setup Program**

### IDE Controller

Enables the integrated local-bus integrated drive electronics (IDE) adapter. Available options are **Both** (the default), **Disabled**, or **Primary**. If **Both** is selected, you can access both the hard-disk drive and the CD-ROM drive. If **Primary** is selected, only the hard-disk drive is accessible.

## *FDD Controller*

Enables the diskette-drive controller. If this option is set to **Disabled**, the diskette drive is unavailable.

## *Internal MPEG II*

This option appears if your computer has a digital versatile disc (DVD)-ROM drive. This option allows you to select a device to provide Moving Pictures Experts Group (MPEG)-2 capabilities. **Enabled** (the default) selects the internal MPEG-2 card. **Disabled** selects a PC card.

## *Serial Port*

**Serial Port** lets you map the address of the serial port to avoid address conflicts with other devices or disable the port for security. The default is **Auto**, and the default base input/output (I/O) and interrupt request (IRQ) address is 3F8 IRQ4. Dell recommends that you retain the default.

If for some reason you need to change the serial port address, be careful not to create a conflict with the address of the infrared port.



*NOTE: If there is a conflict between two or more addresses, an asterisk appears next to the port type in the **System Devices** menu.*

## *Infrared Port*

**Infrared Port** lets you map the address of the infrared port to avoid address conflicts with other devices. The default is **Disabled**. Dell recommends that you retain the default settings.

If for some reason you need to change the infrared port address in the Setup program, be careful not to create a conflict with the addresses of the serial port or the parallel port.



*NOTE: If there is a conflict between two or more addresses, an asterisk appears next to the port type in the **System Devices** menu.*

## *Parallel Port*

**Parallel Port** controls whether the computer's parallel port acts as advanced technology (AT)-compatible (unidirectional), Personal System (PS)/2-compatible (bidirectional), Enhanced Parallel Port (EPP)-compatible, or Extended Capabilities Port (ECP)-compatible. Options are **Enabled**, **Disabled**, and **Auto** (the default). The default is **ECP**. Other possible mode settings are **Normal**, **EPP**, and **bidirectional**.

When set to **Disabled**, you can disable the port and free its assigned LPT address for another device.

When set to **Enabled**, you configure the port settings. The default base I/O address is 378h. If for some reason you need to change the parallel port address and/or direct

memory address (DMA) channel, be careful not to create a conflict with the address or DMA channel of the infrared port.



*NOTE: If there is a conflict between two or more addresses, an asterisk appears next to the port type in the **System Devices** menu.*

## Security Menu Options

The following subsections explain each option in the **Security** menu of the Setup program (see Figure 2-3). The same information is also available in the topic titled “Security Menu” in the *System User's Guide*.

PhoenixBIOS Setup Utility			
Main	System Devices	Security	Power Boot Exit
System Password is Clear			Item Specific Help
Set System Password [Enter]			
Password On Boot [Disabled]			
F1 Help	↑↓ Select Item	F5/F6 Change Values	F9 Setup Defaults
ESC Exit	↔ Select Menu	Enter Select % Sub-Menu	F10 Save and Exit

**Figure 2-3. Security Menu of Setup Program**

### System Password

If no system password has been set, the setting for **System Password** is **Clear**. Otherwise, the setting displayed is **Set**.

### Set System Password

Press <Enter> to set up a new system password, and then follow the instructions on your screen. This password restricts access to the Setup program settings.

## Password on Boot

When the **Password On Boot** option is enabled, you must enter a password before the computer loads the operating system into memory. To enable this option, the **System Password** option must be set.

Settings for this option are **Disabled** (the default) and **Enabled**.

## Power Menu Options

The following subsections explain each option in the **Power** menu of the Setup program (see Figure 2-4). The same information is also available in the topic titled "Power Menu" in the *System User's Guide*.

PhoenixBIOS Setup Utility					
Main	System Devices	Security	<b>Power</b>	Boot	Exit
Power Management Mode	[Customized]	Item Specific Help			
Smart CPU Mode:	[Off]				
Standby Time-out:	[Disabled]				
Suspend Time-out:	[Disabled]				
Suspend Mode	[Save to Ram]				
Resume On Modem Ring:	[Disabled]				
Resume On Time of Day:	[Disabled]				
Resume Time:	[00:00:00]				
F1 Help	↑↓ Select Item	F5/F6 Change Values	F9 Setup Defaults		
ESC Exit	↔ Select Menu	Enter Select % Sub-Menu	F10 Save and Exit		

**Figure 2-4. Power Menu of Setup Program**

### Power Management Mode



*NOTE: The power management settings of Windows 98 take precedence over the settings described here. For more information see "Using Windows 98 to Conserve Battery Power," in the System Users Guide.*

**Customized** (the default) allows you to control each power management setting.

Select **Disabled** if you want to disable all power savings, regardless of how the time-out options are set.

Select **Maximum Performance** to configure power saving time-outs as a group to increase the performance of the computer. When this setting is selected, the **Standby Time-Out** option is set automatically to 4 minutes, and the **Suspend Time-Out** option is disabled. The **Smart CPU Mode** option is set automatically to **Off**.

Select **Maximum Power Savings** to configure the power saving time-outs as a group to save the most battery power. When this setting is selected, the **Standby Time-Out** option is set automatically to 1 minute, and the **Suspend Time-Out** option is set automatically to 5 minutes. The **Smart CPU Mode** option is set automatically to **On**.



### Smart CPU Mode

*NOTE: The power management settings of Windows 98 take precedence over the settings described here. For more information see "Using Windows 98 to Conserve Battery Power," in the System Users Guide.*

**Smart CPU Mode** allows the computer to slow down the microprocessor automatically if it is not being used. Settings for this option are:

- **On** — Allows the computer to slow down the microprocessor when it is inactive
- **Off** (the default) — Keeps the microprocessor running at its normal operating speed regardless of microprocessor inactivity

To increase battery operating time, set the **Smart CPU Mode** option to **On**.

When the **Smart CPU Mode** option is enabled and the microprocessor is inactive, the computer slows the microprocessor to save power.



*NOTES: Some communications software may not work properly when **Smart CPU Mode** is enabled. Dell recommends that you set **Smart CPU Mode** to **Off** if you are using communications software.*

*Interactive application programs should function well when **Smart CPU Mode** is enabled. (Examples of interactive programs include spreadsheet, text editor, graphics design, entertainment, educational, and utility programs.) However, you may experience performance degradation when recalculating a large spreadsheet or during an extensive screen redraw in a graphical program. Benchmark utilities may not perform as intended when doing microprocessor speed tests. If the software you use suffers significant performance degradation, set **Smart CPU Mode** to **Off**.*



### Standby Time-Out

*NOTE: The power management settings of Windows 98 take precedence over the settings described here. For more information see "Using Windows 98 to Conserve Battery Power," in the System Users Guide.*

Standby mode conserves battery power by stopping some computer activity, but leaves the computer ready to resume operations immediately. Use standby mode when you leave the computer unattended for less than a few minutes. Press <Fn><Esc> to enter standby mode when you are in Windows 98. Resume normal computer activity by moving the cursor or pressing any key on the built-in keyboard (the computer takes less than a second to return to normal operation).

The **Standby Time-Out** option lets you determine how long the computer remains idle (no I/O activity) before activating standby mode to conserve battery power. Settings for this option are **Disabled**, **1 min.**, **2 min.**, **4 min.**, **6 min.**, **8 min.**, **12 min.**, and **16 min.**

To increase battery operating time, set this option to a lower number of minutes. Press any key on the built-in keyboard to resume normal computer operation.

If the time delay you set for standby mode is greater than the delay set for suspend mode, the computer enters standby mode first. For instance, if **Standby Time-Out** is set for 8 minutes and **Suspend Time-Out** is set for 5 minutes, the computer enters standby mode after 8 minutes of no I/O activity and then enters save-to-disk suspend mode 5 minutes later.



*NOTE: Set this option to **Disabled** if it causes compatibility problems with your software.*

### Suspend Time-Out



*NOTE: The power management settings of Windows 98 take precedence over the settings described here. For more information see "Using Windows 98 to Conserve Battery Power," in the System Users Guide.*

**Suspend Time-Out** lets you determine how long the computer remains idle (no I/O activity) before activating save-to-disk suspend mode. Settings for this option are **Disabled**, **5 min.**, **10 min.**, **15 min.**, **20 min.**, **30 min.**, **40 min.**, and **60 min.**

To increase battery operating time, set this option to a lower number of minutes.

If the time delay you set for suspend mode is greater than the delay set for standby mode, the computer enters save-to-disk suspend mode first. For instance, if **Suspend Time-Out** is set for 10 minutes and **Standby Time-Out** is set for 4 minutes, the computer enters save-to-disk suspend mode after 10 minutes of no I/O activity and then enters standby mode 4 minutes later.



*NOTE: Set this option to **Disabled** if it causes compatibility problems with your software.*

If you are not in the Setup program, you can activate save-to-RAM suspend mode at any time by pressing <Fn><Esc>. Alternatively, click the **Start** button, and then click **Suspend**. Press the power button to resume normal computer operation.

You can activate save-to-disk suspend mode by pressing <Fn><a> (or <Fn><q> on the French keyboard). Press the power button and hold it down for a second or two to turn on the computer and resume normal operation.

### Suspend Mode



*NOTE: The power management settings of Windows 98 take precedence over the settings described here. For more information see "Using Windows 98 to Conserve Battery Power," in the System Users Guide.*

The **Suspend Mode** category has two options—**Save to RAM** and **Save to Disk**.

**Save-to-RAM** (the default) suspend mode conserves battery power by stopping almost all computer activity, but leaves the computer ready to resume operations in seconds. Select the **Save-to-RAM** option whenever you leave the computer unattended for more than a few minutes. Resume normal computer activity by pressing the power button (the computer may take several seconds to return to normal operation).

**Save-to-disk** suspend mode copies all system data to a reserved area on the hard-disk drive and then turns off all power to the computer. When you resume normal operation, the same programs will be running and the same files will be open that were loaded before you activated this mode. Use **Save-to-disk** suspend mode to conserve battery power or to preserve system data by quickly saving it to the hard-disk drive if you are about to run out of battery power.

### *Resume on Modem Ring*

Setting this option to **Enabled** (the default) tells the computer to resume normal operation when an incoming call is detected by a modem and the computer is in standby mode.

### *Resume on Time of Day*

When the **Resume on Time of Day** option is set to **Enabled**, the computer resumes normal operation at the time specified in the **Resume Time** field after being in standby mode. The default for this option is **Disabled**.

### *Resume Time*

**Resume Time** lets you specify a time when the computer should get out of standby mode and resume normal operation.

## **Boot Menu Options**

The following subsections explain each option in the **Boot** menu of the Setup program (Figure 2-5). The selections you make in this menu determine which disk device the computer uses to find the software needed to start the operating system. The same information is also available in the topic titled "Boot Menu" in the *System User's Guide*.



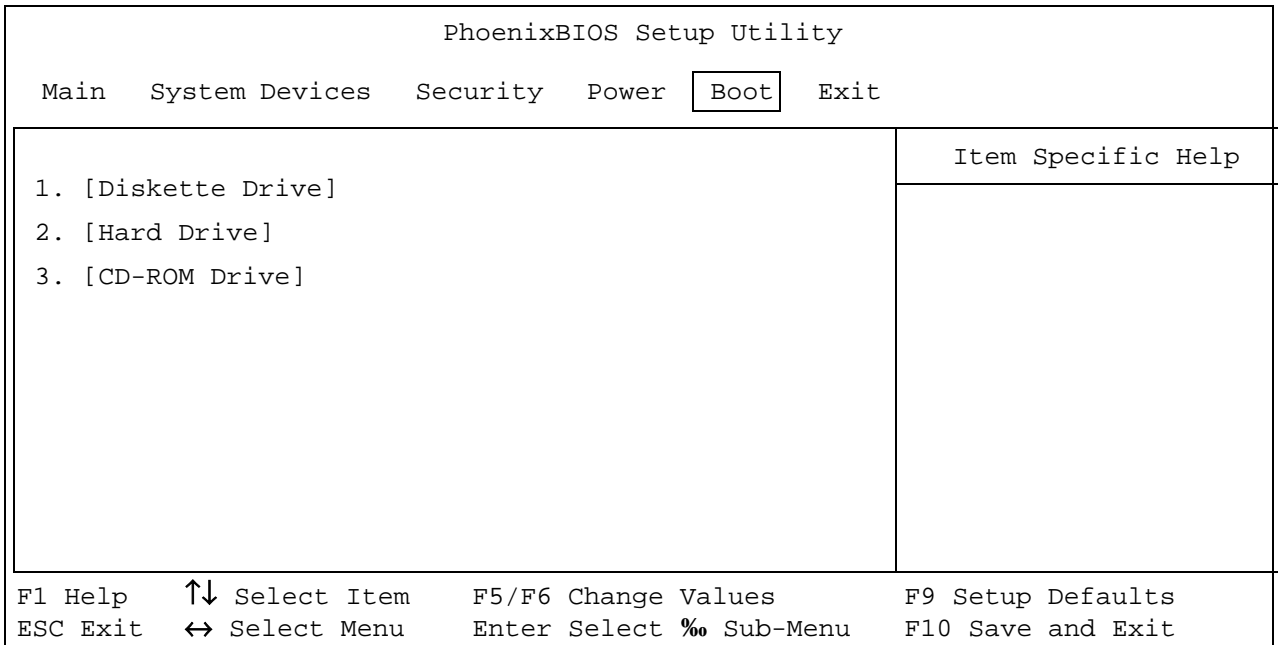

**Figure 2-5. Boot Menu of Setup Program**

To select the boot device, use the up- or down-arrow key; then press <F6> to move the device up the list or <F5> to move the device down the list.

If **Diskette Drive** appears first (the default), the computer attempts to boot first from a bootable diskette. If it does not detect a diskette in the diskette drive, the computer tries to boot from the hard-disk drive. If there is a diskette in the diskette drive, but the diskette does not have the required boot files, an error message is displayed.

**Hard Drive** first causes the computer to boot only from the hard-disk drive. If it fails to boot from the hard-disk drive, the computer does not attempt to boot from the diskette drive.

**CD-ROM Drive** first causes the computer to attempt booting first from a bootable CD. If it does not detect a bootable CD in the CD-ROM drive, the computer tries to boot from the hard-disk drive. If there is a CD in the CD-ROM drive, but the CD does not have the required boot files, an error message is displayed.

### **Exit Menu Options**

The following subsections explain each option in the **Exit** menu of the Setup program (Figure 2-6). The selections you make in this menu determine which disk device the computer uses to find the software needed to start the operating system. The same information is also available in the topic titled "Exit Menu" in the *System User's Guide*.

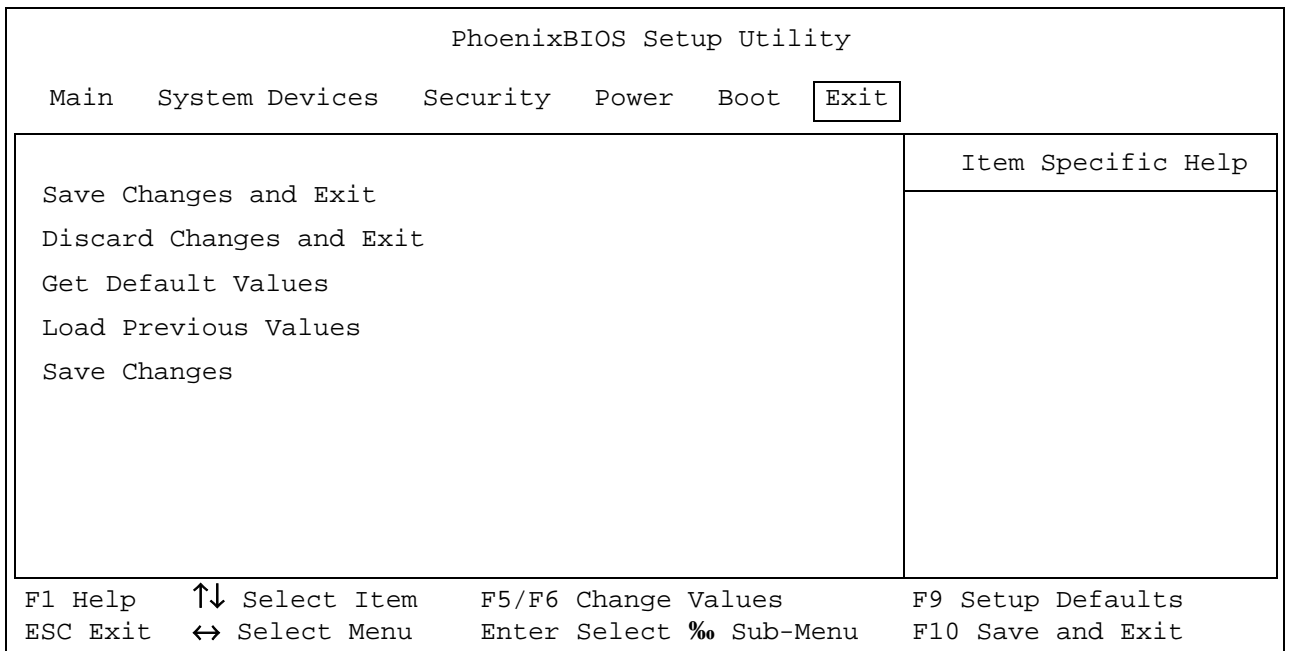

**Figure 2-6. Exit Menu of Setup Program**

### *Save Changes and Exit*

After you have changed a setting in the Setup program, select this option to save the changes into NVRAM and exit the Setup program.

If you try to exit the Setup program without saving your changes, you are prompted to save.

### *Discard Changes and Exit*

Select this option only if you do not want to save the changes you made in the Setup program.

### *Get Default Values*

**Get Default Values** lets you select the default settings for each option in the Setup program. Press <Enter> when prompted to continue. Then you can make more changes in the Setup program or select **Save Changes and Exit**.

### *Load Previous Values*

**Load Previous Values** lets you discard the settings you have made and restore the settings you previously saved. Press <Enter> when prompted to continue.

## Save Changes

**Save Changes** saves your settings without exiting the Setup program. Press <Enter> when prompted to continue, and then return to other menus to make changes.

## Reinstalling Utilities and Drivers

Dell provides software utilities and drivers that help you control certain features of your computer. If Dell installed Windows 98 on your computer, these utilities and drivers are also already installed.

This section explains how to reinstall utilities and drivers on your Dell portable computer with Windows 98. You may need to use these procedures under the following conditions:

- Dell did not install an operating system or other system software on your computer.
- You are reinstalling the version of Windows 98 that came with your computer, and you need to reinstall the drivers and utilities that Dell provides.
- Some of the drivers and/or utilities that came with your computer are corrupted, and you need to reinstall them individually.
- You have a new hard-disk drive, and you need to install all of the system software.

In order to install the system software you will need the following items:

- The *Microsoft Windows 98* CD.
- The *Microsoft Boot Disk Windows 98 Series* diskette.
- The *Dell Inspiron 7000 System Software* CD.

## Reinstalling Video Drivers

Video drivers control features such as screen resolution and the number of screen colors.



*NOTE: If you need to use extended video modes, check the documentation that came with the application program to determine if the drivers are provided. If not, contact the software manufacturer to get the necessary drivers.*

To reinstall the video drivers, follow these steps:

1. Save your work in all open application programs, because you will need to restart your computer at the end of this procedure to complete the installation.
2. Insert the *Dell Inspiron 7000 System Software* CD into the CD-ROM or DVD-ROM drive.
3. On the desktop, double-click the **My Computer** icon.

4. In the **My Computer** window, double-click the **CD-ROM** or **DVD-ROM** icon, and then double-click the **Video** folder.
5. In the **Video** folder, double-click the **Setup** icon.
6. Follow the instructions on your screen.

### **Reinstalling Touch Pad Drivers**

Touch pad drivers and associated utilities allow you to customize the operation of your touch pad and cursor features. To reinstall the touch pad drivers, follow these steps:

1. Save your work in all open application programs, because you will need to restart your computer at the end of this procedure to complete the installation.
2. Insert the *Dell Inspiron 7000 System Software* CD into the CD-ROM or DVD-ROM drive.
3. On the desktop, double-click the **My Computer** icon.
4. In the **My Computer** window, double-click the **CD-ROM** or **DVD-ROM** icon, and then double-click the **Touchpad** folder.
5. In the **Touchpad** folder, double-click the **Setup** icon.
6. Follow the instructions on your screen.

### **Reinstalling Audio Drivers**

Audio drivers allow you to customize the sound features of your computer. To reinstall the audio drivers, follow these steps:

1. Save your work in all open application programs, because you will need to restart your computer at the end of this procedure to complete the installation.
2. Insert the *Dell Inspiron 7000 System Software* CD into the CD-ROM or DVD-ROM drive.
3. On the desktop, double-click the **My Computer** icon.
4. In the **My Computer** window, double-click the **CD-ROM** or **DVD-ROM** icon, and then double-click the **Audio** folder.
5. In the **Audio** folder, double-click the **Setup** icon.
6. Follow the instructions on your screen.

### **Reinstalling Internal Modem Drivers**

Modem drivers allow you to customize the operation of your optional internal modem. If your computer has an internal modem, follow these steps to install the drivers:

1. Save your work in all open application programs, because you will need to restart your computer at the end of this procedure to complete the installation.

2. Insert the *Dell Inspiron 7000 System Software* CD into the CD-ROM or DVD-ROM drive.
3. On the desktop, double-click the **My Computer** icon.
4. In the **My Computer** window, double-click the **CD-ROM** or **DVD-ROM** icon, and then double-click the **Modem** folder.
5. In the **Modem** folder, double-click the **Setup** icon.
6. Follow the instructions on your screen.

### **Reinstalling DVD-ROM Decoder Drivers**

DVD-ROM decoder drivers allow the MPEG decoder on your optional DVD-ROM drive to decode MPEG files, such as DVD movies. If your computer has a DVD-ROM drive, follow these steps to install the drivers:

1. Save your work in all open application programs, because you will need to restart your computer at the end of this procedure to complete the installation.
2. Insert the *Dell Inspiron 7000 System Software* CD into the CD-ROM or DVD-ROM drive.
3. On the desktop, double-click the **My Computer** icon.
4. In the **My Computer** window, double-click the **CD-ROM** or **DVD-ROM** icon, and then double-click the **DVD** folder.
5. In the **DVD** folder, double-click the **Setup** icon.
6. Follow the instructions on your screen.

### **Creating the Save-to-Disk Suspend File**

If you are installing a new hard-disk drive or if you are rebuilding a hard-disk drive that has corrupted software and you want to be able to use the save-to-disk suspend mode, you must use the **phdisk.exe** utility on your *System Utilities* diskette to create a save-to-disk suspend file. When save-to-disk suspend mode is activated, all system data is stored in this file.

To create the save-to-disk suspend file, follow these steps:

1. Insert the *Microsoft Boot Disk Windows 98 Series* diskette into the diskette drive.
2. Restart the system.
3. When the **Microsoft Windows 98 Startup Menu** appears, select **Start computer with CD-ROM Support** and press <Enter>.
4. When the MS-DOS prompt appears, insert the *Dell Inspiron 7000 System Software* CD into the CD-ROM or DVD-ROM drive.

5. At the MS-DOS prompt, type `d:` and press `<Enter>`, where `d` is the drive letter for your CD-ROM or DVD-ROM drive.

Your MS-DOS prompt changes from an `A:\>` to a `D:\>`, assuming `D` is the drive letter for your CD-ROM or DVD-ROM drive.

6. Type `cd\utilities` and press `<Enter>`.
7. Type `PHDISK /CREATE /FILE` and press `<Enter>`.



*NOTE: Make sure there is a space between `PHDISK /CREATE` and `/FILE`.*

The utility calculates the size of the file, in kilobytes, based on the amount of system memory in your computer, plus 2 MB to handle video memory and additional system requirements.

8. Follow the instructions on your screen to create the save-to-disk suspend file.

To check the size of the save-to-disk suspend file, at an MS-DOS prompt type `PHDISK /INFO` and press `<Enter>`

If you need to delete the save-to-disk suspend file, at an MS-DOS prompt type `PHDISK /DELETE /FILE` and press `<Enter>`:

## **Reinstalling the System User's Guide**

If needed, you can download the *Dell Inspiron 7000 System User's Guide* from Dell's World Wide Web (WWW) site at <http://www.dell.com/>:

1. Click the **Support** icon.  
The **Dell Support** main menu appears.
2. Click **Troubleshoot Your Dell System**, and then locate the link to the Inspiron page.
3. Select **7000**.
4. Click **Technical Information**, and then click **Documentation**.
5. Click **System User's Guide**.
6. When prompted, save the file to your hard-disk drive.





# CHAPTER 3

## Troubleshooting Your Computer

If your Dell Inspiron 7000 is not working as expected, this chapter provides initial checks for solving basic computer problems as well as detailed troubleshooting procedures. It lists system messages and beep codes, their possible causes, and actions you can take to resolve any problems indicated by a message or code. This chapter also offers general guidelines for analyzing some software problems.



*NOTES: When you see the question "Is the problem resolved?" in a troubleshooting procedure, repeat the operation that caused the problem to see if it still occurs.*

*Before you begin any of the troubleshooting procedures, make sure the **Quiet Boot** option is set to **Disabled** in the **Main** menu of the Setup program. See Chapter 2, "Customizing System Features," for information on using the Setup program.*



**CAUTION: The only time you should ever access the inside of your computer is when you are installing memory modules.**



**CAUTION: Wait 5 seconds after turning off the computer before disconnecting a peripheral device or removing a memory module to help prevent possible damage to the system board.**



**CAUTION: See "Protecting Against Electrostatic Discharge" in the safety instructions at the front of this guide.**

### Backing Up Your Files

You can lose data when a computer failure occurs. If your computer is behaving erratically, back up your files immediately. See your operating system documentation for instructions on backing up files.



## Basic Checks

The following procedure leads you through the checks necessary to solve some basic computer problems:

1. Is your computer wet or damaged?

**Yes.** Go to “Troubleshooting a Wet Computer” or “Troubleshooting a Damaged Computer” found later in this chapter.

**No.** Go to step 2.

2. Perform the steps in the next subsection, “Checking Connections.”

Is the problem resolved?

**Yes.** A connection to your computer was loose. The problem is resolved.

**No.** Go to step 3.

3. Perform the steps found in “Look and Listen” found later in this chapter.

Did your computer complete the boot (start-up) routine?



*NOTE: The boot routine is the operating system's attempt to load its files into memory from the boot-up sector on the hard-disk drive or bootable diskette.*

**Yes.** Go to step 4.

**No.** Call Dell for technical assistance. (See Chapter 5, “Getting Help,” for instructions.)

4. Did you receive a system message or beep code?

A single beep always sounds during the boot routine when the speaker is tested.

**Yes.** Go to “Messages and Codes” found later in this chapter.

**No.** Go to step 5.

5. Verify the system setup settings as explained in Chapter 2, “Customizing System Features.”

Is the problem resolved?

**Yes.** The system configuration information was incorrect. The problem is resolved.

**No.** Go to step 6.

6. Run the Dell Diagnostics. (See Chapter 4, “Running the Dell Diagnostics.”)

## Checking Connections

Loose or improperly connected cables are likely sources of problems for your computer, external monitor, or other peripherals (such as a printer, external keyboard, or mouse). A quick check of all cable connections can easily solve these problems. If the connector has two small screws, make sure the screws are tight. In addition, check for damaged or frayed cables and for bent pins on connectors.

Be sure the following items are properly connected or installed, as shown in Figures 3-1 through 3-4:

- The AC adapter and the AC power cable

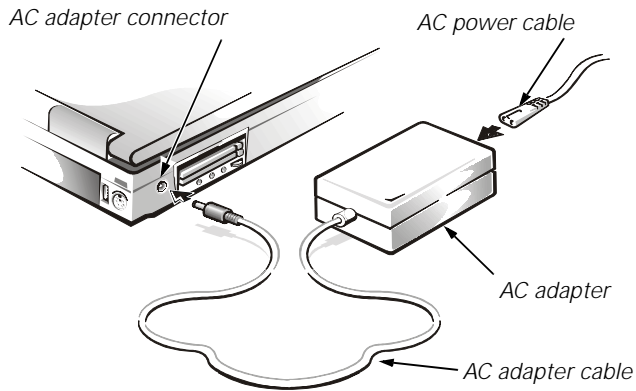

**Figure 3-1. AC Adapter and Power Cable**

- The main battery

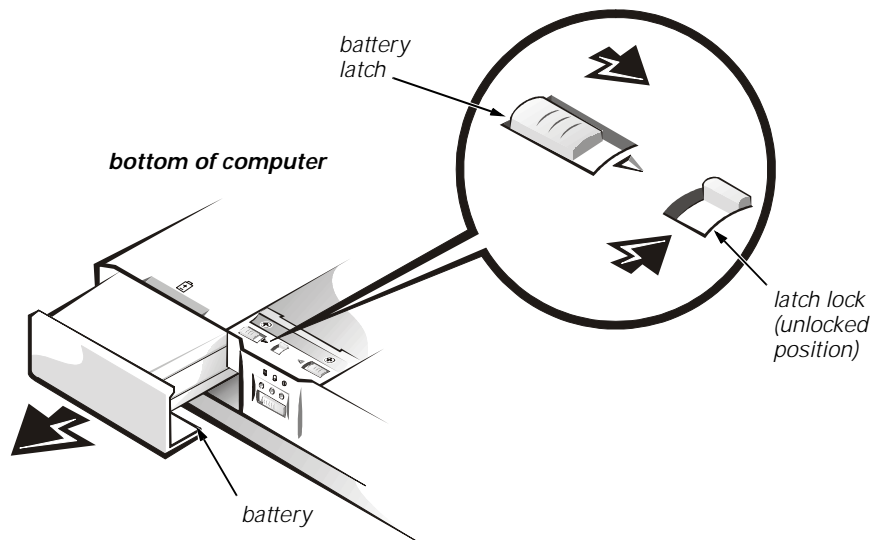

**Figure 3-2. Checking the Battery**

- The secondary battery or any other optional device installed in the options bay

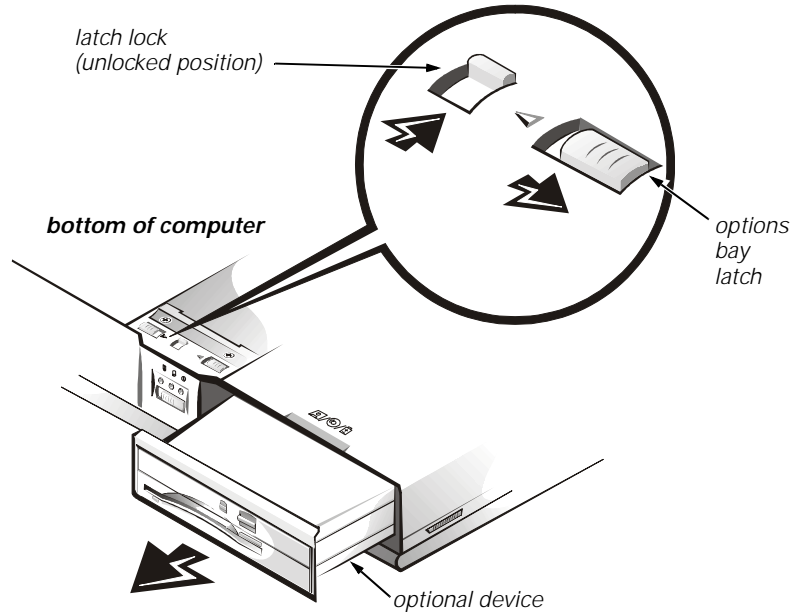

**Figure 3-3. Checking an Optional Device**

- Cables that connect external devices through the input/output (I/O) panel on the back of the computer.

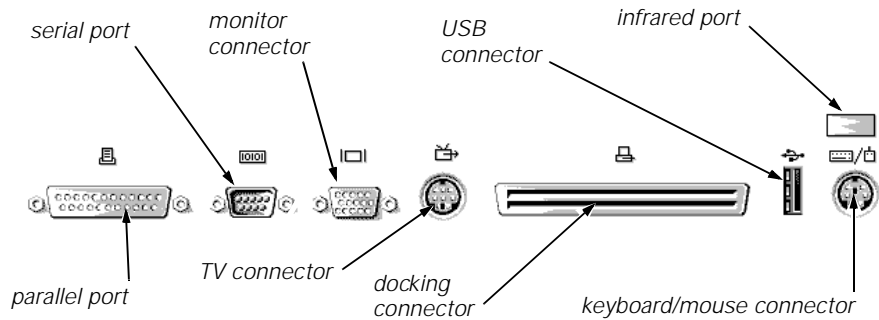

**Figure 3-4. I/O Panel Connectors for External Devices**

## Look and Listen

Looking at and listening to your computer is important in determining the source of a problem. Look and listen for the indications described in Table 3-1.

If the problem is still not resolved, see the next subsection, "Setup Options."



*NOTE: Before you begin any of the troubleshooting procedures, make sure the **Quiet Boot** option is set to **Disabled** in the **Main** menu of the Setup program. See Chapter 2, "Customizing System Features," for information on using the Setup program.*

**Table 3-1. Boot Routine Indications**

<b>Look for:</b>	<b>Action</b>
An error message	See "Messages and Codes" found later in this chapter.
The power indicator	If the computer's power indicator does not come on, see "Troubleshooting a Power Failure" found later in this chapter.
The keyboard indicators	Press the <Num Lock> key, the <Caps Lock> key, and the <Scroll Lock> key to toggle their respective indicators on and off in the status display panel. If the indicators do not appear, run the Keyboard test group in the Dell Diagnostics (for instructions, see Chapter 4, "Running the Dell Diagnostics").
The diskette-drive access indicator	The diskette-drive access indicator should appear in the status display when data is accessed on the diskette drive. You can test this indicator by inserting a diskette into the drive, typing <code>dir a:</code> at an MS-DOS prompt, and pressing <Enter>. If the diskette-drive access indicator does not appear, see "Troubleshooting the Diskette Drive" found later in this chapter.
The CD-ROM/hard-disk drive access indicator	The CD-ROM/hard-disk drive access indicator should appear when data is accessed on the CD-ROM drive or the hard-disk drive. You can test this indicator by typing <code>dir c:</code> at an MS-DOS prompt and pressing <Enter>. If the CD-ROM/hard-disk drive access indicator does not appear, see "Troubleshooting the Hard-Disk Drive" or "Troubleshooting the CD-ROM Drive" found later in this chapter.
<b>Listen for:</b>	<b>Action</b>
A series of beeps	See "Messages and Codes" found later in this chapter.
An unfamiliar constant scraping or grinding sound when a drive is accessed	Make sure the sound is not caused by the application program that is running. The sound could also be caused by a hardware malfunction. See Chapter 5, "Getting Help," for instructions on obtaining technical assistance from Dell.
The absence of a familiar sound	When you turn on the computer, you can hear the hard-disk drive spin up, and the computer tries to access the boot files from the hard-disk drive or the diskette drive. If your computer does not boot, call Dell for technical assistance. (See Chapter 5, "Getting Help," for instructions.) Otherwise, see Chapter 4, "Running the Dell Diagnostics."

*NOTE: For the full name of an abbreviation or acronym used in this table, see the Glossary in the System User's Guide.*

## Setup Options

You can easily correct certain system problems by verifying the settings for setup options. When you boot the computer, it compares the system configuration information with the current hardware configuration. If the computer's hardware configuration doesn't match the information recorded by the system setup options, an error message may appear on the display.

To fix this problem, correct the appropriate options in the Setup program. See Chapter 2, "Customizing System Features," for detailed information about the Setup program and its options.

If, after checking the setup options, you have not resolved the problem, see Chapter 4, "Running the Dell Diagnostics."

## Messages and Codes

The application programs, operating system, and the computer itself are capable of identifying problems and alerting you to them. When this occurs, a message may appear on the computer's display or an external monitor (if one is attached), or a beep code may sound.

If an error message appears on the display or external monitor, make a note of the message. See Table 3-2 for an explanation of the message and suggestions for correcting any errors. The system messages are listed alphabetically.



*NOTE: If the message is not listed in Table 3-2, check the documentation for the application programs that were running at the time the message appeared and/or the operating system documentation for an explanation of the message and a recommended action.*

**Table 3-2. System Error Messages**

Message	Cause	Action
Diskette drive A error	A connector may be loose or the diskette may be faulty.	If the diskette-drive access indicator appears in the status display panel, try a different diskette. If the problem persists, shut down the computer, remove the combination module completely, and then reinsert it. Turn the computer back on, and check for the error message.  If the problem is still not resolved, see "Troubleshooting the Diskette Drive" found later in this chapter.
Extended RAM failed at off- set: <i>nnnn</i>	Extended memory is not configured properly or has failed at the memory address <i>nnnn</i> .	Call Dell for technical assistance. (For instructions, see Chapter 5, "Getting Help.")

*NOTE: For the full name of an abbreviation or acronym used in this table, see the Glossary in the System User's Guide.*

**Table 3-2. System Error Messages** (continued)

<b>Message</b>	<b>Cause</b>	<b>Action</b>
Failing bits: <i>nnnn</i>	Memory failed at RAM address <i>nnnn</i> .	Call Dell for technical assistance. (For instructions, see Chapter 5, "Getting Help.")
Fixed disk 0 failure	The hard-disk drive failed to initialize.	See "Troubleshooting the Hard-Disk Drive" found later in this chapter.
Fixed disk controller failure	The hard-disk drive controller may be faulty.	Call Dell for technical assistance. (For instructions, see Chapter 5, "Getting Help.")
Incorrect drive A type—run Setup	The diskette drive is not identified properly in the Setup program.	Shut down the computer, remove the combination module completely, and then reinsert it. Turn the computer back on, and check for the error message.  If the problem persists, reboot the computer and press <F2> to enter the Setup program. Write down the setting for <b>FDD Controller</b> in the <b>Main</b> menu. Then call Dell for technical assistance. (For instructions, see Chapter 5, "Getting Help.")
Keyboard controller error	The keyboard controller is faulty.	Call Dell for technical assistance. (For instructions, see Chapter 5, "Getting Help.")
Keyboard error	If an external keyboard is being used, a cable or connector may be loose or the keyboard may be faulty. If the built-in keyboard is being used, it may be faulty. A key on the built-in keyboard may have been pressed while the computer was booting.	Run the Stuck Key Test in the Dell Diagnostics. (For instructions, see Chapter 4, "Running the Dell Diagnostics.")
Operating system not found	The operating system may be corrupted. Or, the operating system cannot be found on the hard-disk drive or on the diskette in the diskette drive.	Reinstall the operating system. See the documentation that came with the operating system. If the problem is still not resolved, call Dell for technical assistance. (For instructions, see Chapter 5, "Getting Help.")
Parity check 1 <i>nnnn</i>	A parity error was found in the system bus at address <i>nnnn</i> .	Call Dell for technical assistance. (For instructions, see Chapter 5, "Getting Help.")
Parity check 2 <i>nnnn</i>	A parity error was found in the I/O bus at address <i>nnnn</i> .	Call Dell for technical assistance. (For instructions, see Chapter 5, "Getting Help.")
Real time clock error	The CMOS battery that supports data stored in NVRAM may be dead.	Call Dell for technical assistance. (For instructions, see Chapter 5, "Getting Help.")

NOTE: For the full name of an abbreviation or acronym used in this table, see the Glossary in the System User's Guide.

**Table 3-2. System Error Messages** (continued)

<b>Message</b>	<b>Cause</b>	<b>Action</b>
Shadow RAM failed at off-set: <i>nnnn</i>	Shadow RAM failed at address <i>nnnn</i> .	Call Dell for technical assistance. (For instructions, see Chapter 5, "Getting Help.")
CMOS battery is dead—Replace and run Setup	The CMOS battery does not have enough charge to power the computer.	Call Dell for technical assistance. (For instructions, see Chapter 5, "Getting Help.")
System cache error—cache disabled	The primary cache internal to the microprocessor has failed.	Call Dell for technical assistance. (For instructions, see Chapter 5, "Getting Help.")
System CMOS checksum bad—run Setup	The BIOS has been updated. CMOS has been corrupted or modified, possibly by an application program that changes data stored in CMOS.	Reboot the computer and press <F2> to enter the Setup program and reconfigure the system. If the problem persists, call Dell for technical assistance. (For instructions, see Chapter 5, "Getting Help.")
System RAM failed at off-set: <i>nnnn</i>	System RAM failed at address <i>nnnn</i> in the 64-KB block at which the error was detected.	Call Dell for technical assistance. (For instructions, see Chapter 5, "Getting Help.")
System timer error	A chip on the system board may be malfunctioning.	Run the System Set test group and the Keyboard Controller Test in the Dell Diagnostics. (For instructions, see Chapter 4, "Running the Dell Diagnostics.")

NOTE: For the full name of an abbreviation or acronym used in this table, see the Glossary in the System User's Guide.

## System Beep Codes

When errors occur during the boot routine that cannot be reported on the built-in display or on an external monitor (if attached), the computer may emit a series of beeps that identify the problem. The *beep code* is a pattern of sounds: for example, one beep, followed by a second beep, and then a burst of three beeps (code 1-1-3) means that the computer was unable to read the data in nonvolatile random-access memory (NVRAM). This information is important to the Dell support staff if you need to call for technical assistance.

When a beep code is emitted, write it down on a copy of the Diagnostics Checklist found in Chapter 5, and then look it up in Table 3-3. If you are unable to resolve the problem by looking up the meaning of the beep code, use the Dell Diagnostics to identify a more serious cause. (See Chapter 4, "Running the Dell Diagnostics.") If you are still unable to resolve the problem, call Dell for technical assistance. (See Chapter 5, "Getting Help," for instructions.)

**Table 3-3. Beep Codes**

<b>Message</b>	<b>Cause</b>	<b>Action</b>
1-2	Memory module not being properly identified or used	See "Troubleshooting Memory" found later in this chapter.
1-2-2-3	ROM BIOS checksum failure	Run the System Set test group in the Dell Diagnostics. (See Chapter 4, "Running the Dell Diagnostics," for instructions.) If the program does not load, call Dell for technical assistance. (For instructions, see Chapter 5, "Getting Help.")
1-3-1-1	DRAM refresh failure	Run the System Set test group in the Dell Diagnostics. (See Chapter 4, "Running the Dell Diagnostics," for instructions.) If the program does not load, call Dell for technical assistance. (For instructions, see Chapter 5, "Getting Help.")
1-3-1-3	Keyboard controller test failure	Run the Keyboard Controller Test in the Dell Diagnostics. (For instructions, see Chapter 4, "Running the Dell Diagnostics.")
1-3-4-1	RAM failure on address line <i>nnnn</i>	Run the RAM test group in the Dell Diagnostics. (See Chapter 4, "Running the Dell Diagnostics," for instructions.) If the program does not load, call Dell for technical assistance. (For instructions, see Chapter 5, "Getting Help.")
1-3-4-3	RAM failure on data bits <i>nnnn</i> of the high byte on the memory bus	Run the RAM test group in the Dell Diagnostics. (See Chapter 4, "Running the Dell Diagnostics," for instructions.) If the program does not load, call Dell for technical assistance. (For instructions, see Chapter 5, "Getting Help.")
1-4-1-1	RAM failure on data bits <i>nnnn</i> of the low byte on the memory bus	Run the RAM test group in the Dell Diagnostics. (See Chapter 4, "Running the Dell Diagnostics," for instructions.) If the program does not load, call Dell for technical assistance. (For instructions, see Chapter 5, "Getting Help.")
2-1-2-3	Check ROM copyright notice failure	Run the System Set test group in the Dell Diagnostics. (See Chapter 4, "Running the Dell Diagnostics," for instructions.) If the program does not load, call Dell for technical assistance. (For instructions, see Chapter 5, "Getting Help.")
2-2-3-1	Interrupt mask register failure	Call Dell for technical assistance. (For instructions, see Chapter 5, "Getting Help.")

*NOTE:* For the full name of an abbreviation or acronym used in this table, see the Glossary in the System User's Guide.



## **Finding Software Solutions**

Because most computers have several application programs installed in addition to the operating system, isolating a software problem can be confusing. Software errors can also appear to be hardware malfunctions at first. Software problems can result from the following circumstances:

- Improper installation or configuration of a program
- Input errors
- Drivers that may conflict with certain application programs
- Memory conflicts resulting from the use of terminate-and-stay-resident (TSR) programs, such as drivers
- Interrupt conflicts between devices

You can confirm that a computer problem is caused by software by first running the System Set test group as described in Chapter 4, "Running the Dell Diagnostics." If all tests in the test group complete successfully, the error condition is most likely caused by software.

The following subsections provide general guidelines for analyzing some software problems. For detailed troubleshooting information on a particular program, see the documentation that accompanied the software or consult the support service for the software.

## **Installing and Configuring Software**

When you obtain software, check it for viruses using virus-scanning software before installing it on the computer's hard-disk drive. Viruses can quickly use all available system memory, damage and/or destroy data stored on the hard-disk drive, and permanently affect the performance of the programs they infect. Several commercial virus-scanning programs are available for purchase, and most bulletin board services (BBSs) archive freely distributed virus-scanning programs that you can download with a modem.

Before installing a program, read its documentation to learn how the program works, what hardware it requires, and what its defaults are. A program usually includes installation instructions in its accompanying documentation and a software installation routine on its program diskettes.

The software installation routine assists you in transferring the appropriate program files to the computer's hard-disk drive. Installation instructions may provide details about how to configure the operating system to successfully run the program. Always read the installation instructions before running a program's installation routine. If you are instructed to modify the start-up files, see the documentation that came with the operating system for instructions.

When you run the installation routine, be prepared to respond to prompts for information about how the computer's operating system is configured, what type of computer you have, and what peripherals are connected to the computer.

## ***Start-Up Files***

Whenever you start or reboot the computer, the operating system executes commands from its start-up files.

These files contain commands that automatically configure the operating system by setting system parameters, starting memory-resident programs, and loading device driver software. If you experience program conflicts or memory error messages, check the commands for memory-resident programs in the start-up files of the operating system. (For information on start-up files, see the documentation that came with the operating system). If a program or peripheral does not work correctly, check the product's documentation to see if you need to modify these files.

## ***Using Software***

The following subsections discuss errors that can occur while using software.

### ***Error Messages***

Error messages can be produced by an application program, the operating system, or the computer. "Messages and Codes," found earlier in this chapter, discusses the error messages generated by the computer. If you receive an error message not listed in "Messages and Codes," check the operating system or application program documentation.

### ***Input Errors***

If a specific key or set of keys is pressed at the wrong time, a program may give you unexpected results. See the documentation that came with the application program to make sure the values or characters you are entering do not conflict with the application program you are using.

Make sure the operating system is compatible with the programs you use. Keep in mind that whenever you change the parameters of the computer's operating system, you may affect the successful operation of the programs. Sometimes, after modifying the operating system, you may need to reinstall a program that no longer runs properly.

### ***Memory-Resident Programs***

There are a variety of utilities and supplementary programs that can be loaded either when the computer boots or from an operating system prompt. These programs are designed to stay resident in system memory and thus always be available for use. Because they remain in the computer's memory, memory conflicts and errors can result when other programs require use of all or part of the memory already occupied by these TSR programs.

Typically, the operating system's start-up files contain commands to start TSR programs when you boot the computer. If you suspect that one of these TSR programs is causing a memory conflict, remove the commands that start them from the start-up file. If the problem you were experiencing does not recur, one of the TSR programs probably created the conflict. Add the TSR commands back into the start-up files one at a time until you identify which TSR program is creating the conflict.

## Program Conflicts

Some programs may leave portions of their setup information behind, even though you have exited from them. As a result, other programs cannot run. Rebooting the computer can confirm whether or not these programs are the cause of the problem.

Other programs use specialized subroutines called *drivers* that can cause problems in the computer. For example, a variation in the way the data is sent to an external monitor may require a special screen driver program that *expects* a certain kind of video mode or monitor. In such cases, you may have to develop an alternative method of running that particular program—for example, the creation of a boot file made especially for that program. For help with this situation, call the support service offered by the manufacturer of the software you are using.

## Avoiding Interrupt Assignment Conflicts

Problems can arise if two devices attempt to use the same interrupt request (IRQ) line. To avoid this type of conflict, check the documentation for the default IRQ line setting for each installed device. Then consult Table 3-4 to configure the device for one of the available IRQ lines.



*NOTE: Installed devices cannot share the same COM port address. The default address of the computer's serial port is COM1.*

**Table 3-4. IRQ Line Assignments**

IRQ Line	Used/Available
IRQ0	Generated by the system timer
IRQ1	Generated by the keyboard controller to signal that the keyboard output buffer is full
IRQ2	Cascade to second interrupt controller
IRQ3	Reserved
IRQ4	Used by the communications port (COM1)
IRQ5	Used by the audio controller
IRQ6	Generated by the diskette drive controller to indicate that the diskette drive requires the attention of the microprocessor
IRQ7	Used by the parallel port
IRQ8	Generated by the system RTC
IRQ9	Free
IRQ10	Generated by the USB
IRQ11	Generated by the cardbus controller

*NOTE: For the full name of an abbreviation or acronym used in this table, see the Glossary in the System User's Guide.*

**Table 3-4. IRQ Line Assignments** (continued)

IRQ Line	Used/Available
IRQ12	Generated by the keyboard controller to indicate that the output buffer of the integrated touch pad or external PS/2 mouse is full
IRQ13	Used by the math coprocessor on the microprocessor
IRQ14	Generated by the hard-disk drive to indicate that the drive requires the attention of the microprocessor
IRQ15	Generated by the secondary IDE controller (CD-ROM drive) to indicate that the drive requires attention of the microprocessor.

*NOTE: For the full name of an abbreviation or acronym used in this table, see the Glossary in the System User's Guide.*

## Troubleshooting Procedures

This section provides troubleshooting procedures for built-in components (such as the display) and for external devices that connect to the computer (such as an external monitor). Before performing any of the procedures in this section, see “Basic Checks” found earlier in this chapter and read the safety instructions at the front of this guide. Then perform the appropriate troubleshooting procedure for the component or equipment that is malfunctioning.



*NOTES: When you see the question “Is the problem resolved?” in a troubleshooting procedure, perform the operation that caused the problem to see if the problem still occurs.*

*Before you begin any of the troubleshooting procedures, make sure the Quiet Boot option is set to Disabled in the Main menu of the Setup program. See Chapter 2, “Customizing System Features,” for information on using the Setup program.*

### Troubleshooting a Wet Computer

Liquids, spills and splashes, rain, and excessive humidity can cause moisture damage to the computer. If the computer gets wet or if condensation forms on the computer because of humid conditions, use the following procedure.



**WARNING: Perform step 1 of the following procedure only after you are certain that it is safe to do so. If the computer is connected to an alternating current (AC) power source, Dell recommends turning off AC power at the circuit breaker before attempting to remove the power cables from AC power. Use the utmost caution when removing wet cables from live power.**

1. Turn off the computer and disconnect it from the AC adapter. Then disconnect the AC adapter from AC power. Turn off any attached peripherals and disconnect them from their power sources and then from the computer.
2. Remove any installed batteries.

Wipe off each battery and store it in a safe place to dry.

3. If the options bay slot is wet, remove the device from the bay. If the PC Card slot is wet, remove any PC Cards. Put the device and cards in a safe place to dry.
4. Ground yourself by touching one of the metal connectors on the back of the computer.
5. Turn the computer over and remove the two screws at the front of the hard-disk drive carrier. A spring will cause the front edge of the cover to pop up.
6. Pull the hard-disk drive forward until it stops, and then pull it up. When the hard-disk drive is not in the computer, protect the drive from exposure to static electricity.
7. Turn the computer over and remove the memory module cover as shown in Figure 3-5.

Slide the memory module cover as far as it will go in the direction of the arrow and then lift it away from the computer.

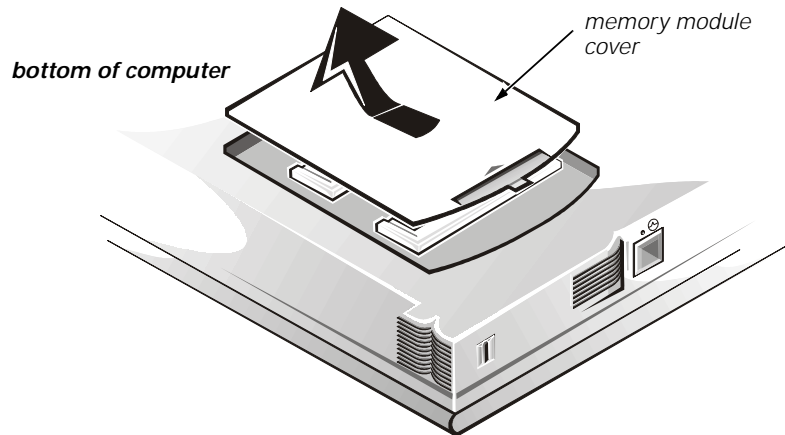

**Figure 3-5. Removing the Memory Module Cover**

8. Open the display, and place the computer across two books or similar props to let air circulate all around it. Let the computer dry for at least 24 hours.

Place the computer in a dry area at room temperature. Do not use artificial means to speed up the drying process.



**WARNING: Before continuing with the remainder of this procedure, verify that the computer is thoroughly dry.**

9. Ground yourself by touching one of the unpainted metal connectors on the I/O panel.
10. Replace the memory module cover.
11. Reinstall the hard-disk drive, align the screw holes, and replace the two screws you removed in step 5.

12. Reinstall the options-bay device or PC Cards that you removed in step 3.
13. Replace any batteries that you removed in step 2.
14. Reconnect the computer and peripherals to AC power and turn them on.
15. Does the computer work properly?

**Yes.** The problem is resolved.

**No.** If the computer is able to boot, run the Dell Diagnostics to identify computer damage. If the computer is unable to boot, see “Troubleshooting a Power Failure” found later in this section. If you cannot identify the damaged component(s), call Dell for technical assistance. (See Chapter 5, “Getting Help,” for instructions.)

## ***Troubleshooting a Damaged Computer***

If the computer is dropped or damaged, use the following procedure:

1. Save all your work, exit any open application programs, and remove any installed batteries.
2. Turn off the computer and disconnect it from the AC adapter. Then disconnect the AC adapter from AC power. Turn off any attached peripherals and disconnect them from their power sources and then from the computer.
3. Ground yourself by touching one of the metal connectors on the back of the computer.
4. Turn the computer over and remove the two screws at the front of the hard-disk drive carrier. A spring will cause the front edge of the cover to pop up.
5. Pull the hard-disk drive forward until it stops, and then pull it up. When the hard-disk drive is not in the computer, protect the drive from exposure to static electricity.
6. Turn the computer over, and remove the memory module cover as shown in Figure 3-6.

Slide the memory module cover as far as it will go in the direction of the arrow and then lift it away from the computer.

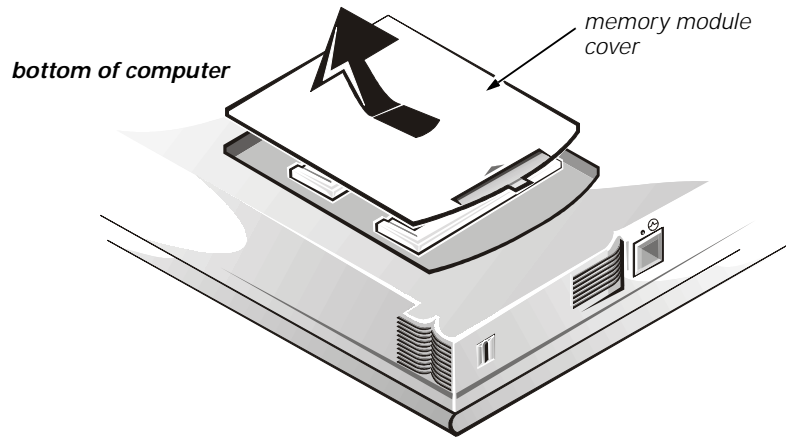

**Figure 3-6. Removing the Memory Module Cover**

7. Replace the memory module cover.
8. Reinstall the hard-disk drive, align the screw holes, and replace the two screws removed in step 4.
9. Install the combination module in the options bay.
10. Verify that any installed PC Cards are properly seated in the PC Card connectors.
11. Replace any batteries that you removed in step 1.
12. Reconnect the computer and peripherals to AC power and turn them on.
13. Run the Dell Diagnostics to verify that the computer is operating properly. (See Chapter 4, "Running the Dell Diagnostics," for instructions.)
14. If the computer does not operate properly, make a copy of the Diagnostics Checklist found in Chapter 5 and fill it out. Then call Dell for technical assistance. (See Chapter 5, "Getting Help," for instructions.)

### **Troubleshooting a Power Failure**

Occasionally, you may experience a power failure in all or part of the computer. A total power failure is indicated by the absence of electrical activity (such as status indicators and sounds) from the keyboard, display, hard-disk drive, and combination module. In a partial power failure, one or more of these indicators shows that there is power to a part of the computer.

To determine if there is any power to the computer, make a copy of the Diagnostics Checklist found in Chapter 5 and fill it out as you complete the following procedure:

1. Remove all peripherals, including internal devices such as the combination module, hard-disk drive, and battery.
2. Try turning on the computer.

3. Does the computer turn on properly?  
**Yes.** The problem is resolved.  
**No.** Go to Step 4.
4. Turn off the computer. Do the power indicator and battery indicator(s) appear on the status display panel?  
**Yes.** Go to step 5.  
**No.** Go to step 6.
5. Remove any installed batteries and disconnect the AC adapter. Then reinstall the batteries, reconnect the AC adapter, and turn on the computer. Do the power indicator and battery indicator(s) appear on the status display panel?  
**Yes.** Go to step 7.  
**No.** Go to step 6.
6. Turn off the computer, wait a few seconds, and then turn on the computer again. Do the indicators appear on the status display panel?  
**Yes.** Your computer is receiving power. Go to step 7.  
**No.** Your computer is not receiving power. Go to step 8.
7. Does the computer boot successfully?  
**Yes.** The problem is resolved.  
**No.** Go to step 8.
8. Reseat (remove and reinstall) any installed batteries, and check the AC adapter connection. Do the indicators appear in the status display panel?  
**Yes.** The problem is resolved.  
**No.** If the computer is powered by the AC adapter, see the next subsection, "Total Power Failure When Using the AC Adapter." If the computer is using battery power, see "Total Power Failure When Using a Battery" found later in this section.

### ***Total Power Failure When Using the AC Adapter***

If no signs of power are present in the computer when using the AC adapter, make a copy of the Diagnostics Checklist found in Chapter 5 and fill it out as you complete the following procedure:

1. Turn off the computer and peripherals and disconnect them from AC power. If you are using a surge protector, remove it.
2. Make sure the AC adapter is connected to the computer, and then verify that the power cable is firmly attached to the AC adapter and to the AC power source.

See "Checking Connections" found earlier in this chapter.



3. Does the light-emitting diode (LED) on top of the AC adapter turn on?  
**Yes.** Go to step 4.  
**No.** The AC adapter may be defective. Go to step 5.
4. Turn on the computer. Does the power indicator appear in the status display panel?  
**Yes.** The problem is resolved.  
**No.** Go to step 5.
5. Call Dell for technical assistance.  
See Chapter 5, "Getting Help," for instructions.

### ***Total Power Failure When Using a Battery***

If an AC adapter is not connected to your computer, the computer's power source is its battery. If the battery status indicator does not appear in the status display panel when you turn on the computer, the battery's charge may be depleted. If the battery status indicator is empty, the battery may be nearly out of charge or defective. To troubleshoot this problem, make a copy of the Diagnostics Checklist found in Chapter 5 and fill it out as you complete the following procedure:

1. Turn off the computer and peripherals. Disconnect the peripherals from AC power.
2. Reseat each installed battery by first removing and then replacing the battery in its compartment.
3. Turn on the computer. Does the battery status indicator appear in the status display panel?

Allow one minute for the computer to initialize its components before checking for signs of power.

- Yes.** Go to step 4.
- No.** Use the AC adapter to connect your computer to AC power. If the computer operates normally when using AC power, go to step 7. If the computer does not boot when using the AC adapter, see the previous subsection, "Total Power Failure When Using the AC Adapter."
4. Is the battery status indicator blinking?  
**Yes.** Go to step 7.  
**No.** Go to step 5.
  5. Does the battery status indicator remain steady, and does the AC power indicator appear in the status display panel?  
**Yes.** Go to step 6.  
**No.** The battery is defective. Call Dell for technical assistance. (See Chapter 5, "Getting Help," for instructions.)

6. Is there a single bar on the far left of the battery status indicator?

**Yes.** The battery is too hot. Turn off the computer, remove the battery, and then let it cool to room temperature. Then reinstall the battery, reboot the computer, and go back to step 3. (If you return to step 6 the second time you perform this procedure, call Dell for technical assistance. See Chapter 5, "Getting Help," for instructions.)

**No.** Call Dell for technical assistance. (See Chapter 5, "Getting Help," for instructions.)

7. Use the AC adapter to fully charge the battery.

For instructions, see the topic titled "Charging the Battery" in the *System User's Guide*. The battery charges in approximately 2.5 hours, using an AC power source, if the computer is off; the battery charges in approximately 2.5 hours if the computer is on.

8. Does the battery status indicator in the status display panel indicate that the battery is fully charged?

**Yes.** The problem is resolved. Turn on the computer.

**No.** You may have a defective battery. Go to step 9.

9. If a fully charged spare battery is available, install it in the computer.

10. Turn on the computer. Does the battery status indicator appear in the status display panel?

**Yes.** Your original battery is defective. Call Dell for technical assistance. (See Chapter 5, "Getting Help," for instructions.)

**No.** Call Dell for technical assistance. (See Chapter 5, "Getting Help," for instructions.)

### ***No Power to a Part of the Computer***

If the power indicator shows that your computer is receiving power, but the display remains blank, part of your computer is probably not receiving power. To troubleshoot this problem, make a copy of the Diagnostics Checklist found in Chapter 5 and fill it out as you complete the following procedure:

1. Turn off the computer and peripherals and disconnect them from AC power. Disconnect any attached peripherals from the computer.
2. Make sure that the AC adapter is connected to the computer and to AC power, or confirm that a fully charged battery is properly seated in its compartment.

3. Turn on the computer. Is the display on?

Allow one minute for the computer to initialize its components before checking for signs of power.

**Yes.** The entire computer is receiving power; the problem is resolved.

**No.** Adjust the brightness of the display. If the display still does not show an image, call Dell for technical assistance. (See Chapter 5, "Getting Help," for instructions.)

## **Troubleshooting the Diskette Drive**

During the power-on self-test (POST), the computer checks the diskette drive, comparing its characteristics with the system configuration information. (The diskette-drive access indicator appears in the status display panel as the computer performs this check on a diskette drive in the options bay.)

If the drive fails POST or if the access indicators do not appear, make a copy of the Diagnostics Checklist found in Chapter 5 and fill it out as you complete the following procedure:

1. Remove the combination module from the options bay.
2. Save your work in any open application programs, and then shut down the computer.
3. Reinstall the combination module.
4. Reboot the computer. Does the diskette-drive access indicator light blink during the boot routine?

**Yes.** Go to step 6.

**No.** Go to step 5.

5. Remove and reinsert the combination module (or disconnect and reconnect the drive if used externally). Reboot the computer. Does the diskette-drive access indicator light blink during the boot routine?

**Yes.** Go to step 6.

**No.** Go to step 9.

6. Does the computer display a drive error message?

**Yes.** See Table 3-2 for an explanation of the message, and then go to step 7.

**No.** Go to step 9.

7. Insert a bootable 1.44 megabyte (MB) diskette into the drive and reboot the computer.

8. Does the diskette-drive access indicator light blink during the boot routine, and does the drive boot the operating system?

**Yes.** The diskette drive problem has probably been resolved. If you continue to experience trouble, call Dell for technical assistance. (See Chapter 5, "Getting Help," for instructions.)

**No.** Go to step 9.

9. Call Dell for technical assistance.

See Chapter 5, "Getting Help," for instructions.

### ***Troubleshooting the CD-ROM or DVD-ROM Drive***

During POST, the computer checks the CD-ROM or DVD-ROM drive, comparing its characteristics with the system configuration information. (The CD-ROM/hard-disk drive access indicator blinks as the computer performs this check.)

If a failure occurs with the drive, make a copy of the Diagnostics Checklist found in Chapter 5 and fill it out as you complete the following procedure:

1. Remove the combination module from the options bay.
2. Save your work in any open application programs, and then shut down the computer.
3. Reinstall the combination module.
4. Reboot the computer. Does the drive access indicator light blink during the boot routine?

**Yes.** Go to step 6.

**No.** Go to step 5.

5. Remove and reinsert the combination module. Reboot the computer. Does the drive access indicator blink during the boot routine?

**Yes.** Go to step 6.

**No.** Go to step 10.

6. Remove the hard-disk drive and boot the computer. Does the drive access indicator light blink?

**Yes.** Go to step 7.

**No.** Go to step 10.

7. Reinstall the hard-disk drive. Then check the **config.sys** file (in Windows 98, check the CD-ROM or DVD-ROM drive configuration in the **Settings** folder). Is the CD-ROM or DVD-ROM driver (**tsycdrom.sys**) installed?

**Yes.** Go to step 8.

**No.** Load the driver, and return to step 1 to begin this procedure again. (To load the driver, use the program diskette sets you made when you first received your Dell computer.)

8. Insert a bootable diskette into drive A and reboot the computer.
9. Type `d:` and press <Enter>. Then type `dir` and press <Enter>. Does MS-DOS display the root directory contents for drive D?

**Yes.** The problem is resolved.

**No.** Go to step 10.

10. Insert your Dell Diagnostics diskette into drive A and reboot the computer. Then run the IDE CD-ROM Drives test group. Does your CD-ROM drive pass all the tests?

**Yes.** Return to step 1 and perform this troubleshooting procedure again. If you continue to experience trouble, call Dell for technical assistance. (See Chapter 5, "Getting Help," for instructions.)

**No.** Go to step 11.

11. Call Dell for technical assistance.

See Chapter 5, "Getting Help," for instructions.

## ***Troubleshooting the Hard-Disk Drive***

During POST, the computer checks the hard-disk drive, comparing its characteristics with the system configuration information. (The drive access indicator blinks as the computer performs this check.) If a failure occurs with the drive, make a copy of the Diagnostics Checklist found in Chapter 5 and fill it out as you complete the following procedure:

1. Shut down the computer.
2. Reboot the computer. Does the drive access indicator light blink during the boot routine, and does the drive boot the operating system?

**Yes.** If a message appears on the display, see Table 3-2 for an explanation of the message and possible corrective actions. Then go to step 7.

**No.** Go to step 3.

3. Insert a bootable diskette into drive A and reboot the computer.

4. Type `c:` and press <Enter>. Then type `dir` and press <Enter>. Does MS-DOS display the root directory contents for drive C?  
**Yes.** Go to step 6.  
**No.** Go to step 5.
5. If your hard-disk drive has more than one logical drive, type `d:` and press <Enter>. Then type `dir` and press <Enter>. Does MS-DOS display the root directory contents for drive D?  
**Yes.** You may have a corrupted boot sector or file allocation table (FAT) on drive C. Go to step 9.  
**No.** Go to step 8.
6. Rename your **autoexec.bat** and **config.sys** files, remove the operating system diskette from drive A, and reboot the computer. Does the operating system load now?  
**Yes.** You have an error in your **autoexec.bat** or **config.sys** file. Use a text editor to examine the contents of these files and locate the error. For information on the correct syntax for commands in these files, see the documentation that accompanied your operating system.  
**No.** Go to step 7.
7. Insert your diagnostics diskette into drive A and reboot the computer. Then run the Hard-Disk Drives (Non-SCSI) test group. Does your drive pass all the tests?  
**Yes.** Go to step 8.  
**No.** Go to step 9.
8. Replace your diagnostics diskette with the operating system diskette, and reboot the computer. Does the operating system load now?  
**Yes.** The hard-disk drive may contain a corrupted operating system or it may have bad sectors. Reinstall the operating system as described in the documentation that came with it. If reinstalling the operating system does not correct the problem, go to step 9.  
**No.** Go to step 9.
9. Call Dell for technical assistance.  
See Chapter 5, "Getting Help," for instructions.

## ***Troubleshooting an External Keyboard***

When you attach an external keyboard, the built-in keyboard remains fully functional except for the embedded numeric keypad. During POST, the computer checks whether an external keyboard is connected; if it is, the computer recognizes both the built-in keyboard and the external keyboard. If an attached external keyboard does not

work when you boot the computer, make a copy of the Diagnostics Checklist found in Chapter 5 and fill it out as you complete the following procedure:

1. Turn off the computer, and then remove the keyboard cable and check it for bent pins.
2. Reboot the computer.
3. Make sure the cable from the external keyboard is firmly connected to the keyboard/mouse connector on the back of the computer. (See "Checking Connections" found earlier in this chapter.)
4. If you are using a keyboard that can be configured with various switch settings, make sure the switch is set to **PS/2**, **Enhanced XT/AT**, or **PC/AT**.

The switch settings are usually on the bottom of the keyboard, sometimes behind a panel tab.

5. Turn off the computer, wait one minute, and then turn it on again. During the boot routine, do the Num Lock, Caps Lock, and Scroll Lock indicators on the external keyboard blink momentarily?

**Yes.** Go to step 6.

**No.** You may have a defective keyboard. Go to step 9.

6. Does the computer recognize the external keyboard?

Use the external keyboard to type some characters. Do they appear on the display?

**Yes.** The problem is resolved.

**No.** Go to step 7.

7. Turn off the computer and disconnect the external keyboard from the computer.
8. Turn on the computer. Does the computer recognize the integrated keyboard?

Allow one minute for the computer to initialize its components. Then use the computer's integrated keyboard to type some characters. Do the characters appear on the display?

**Yes.** The external keyboard may be defective. Run the Keyboard test group in the Dell Diagnostics. If you cannot isolate the problem after running the diagnostics, call Dell for technical assistance.

**No.** Go to step 9.

9. Call Dell for technical assistance.

See Chapter 5, "Getting Help," for instructions.

## Troubleshooting Memory

During POST, the computer checks the computer's memory, and then writes to and reads from the number of available bytes to ensure proper operation. If the memory count displayed is less than the amount installed, make a copy of the Diagnostics Checklist found in Chapter 5 and fill it out as you complete the following procedure:

1. Reboot the computer. Does the random-access memory (RAM) count displayed correctly match the actual amount of memory installed in the computer?  
**Yes.** The computer needed to update the memory; the memory check phase is OK now.  
**No.** Go to step 2.
2. Save all your work, exit any open application programs, and remove any installed batteries.
3. Turn off the computer and disconnect it from the AC adapter. Then disconnect the AC adapter from AC power. Turn off any attached peripherals, and disconnect them from their power sources and then from the computer.
4. Ground yourself by touching one of the metal connectors on the back of the computer.
5. Turn the computer over and remove the memory module cover as shown in Figure 3-7.

Slide the memory module cover as far as it will go in the direction of the arrow, and then lift it away from the computer.

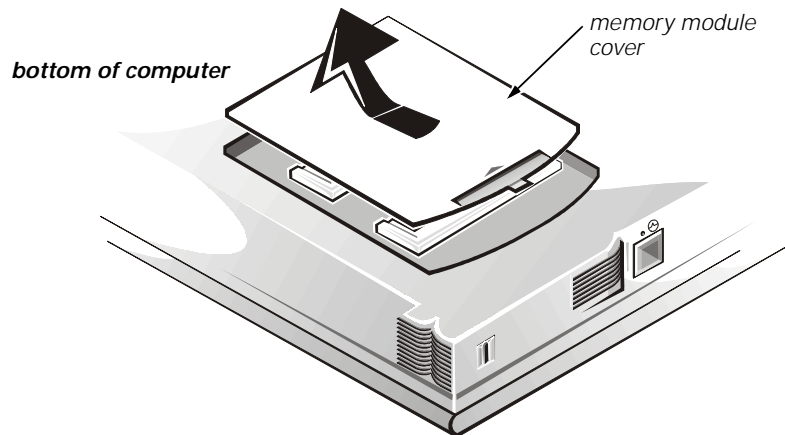

**Figure 3-7. Removing the Memory Module Cover**





**CAUTION:** To prevent damage to the computer, do not use tools to spread the inner metal tabs of the socket when you are installing or removing a memory module.

6. Remove the memory modules as shown in Figure 3-8.

Using your fingernails, carefully spread apart the inner metal tabs of the memory module socket just far enough for the memory module to disengage from the socket (the module should pop up slightly). Then lift the memory module away from the socket.

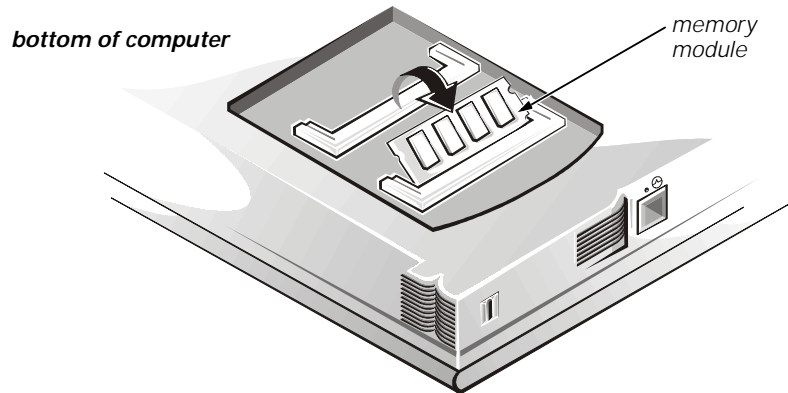

**Figure 3-8. Removing a Memory Module**

7. Install the new memory module(s) as shown in Figure 3-9.

Align the notch in the edge connector with the slot in the center of the memory module socket. Press the memory module's edge connector firmly into the socket. Pivot the module down until it clicks.

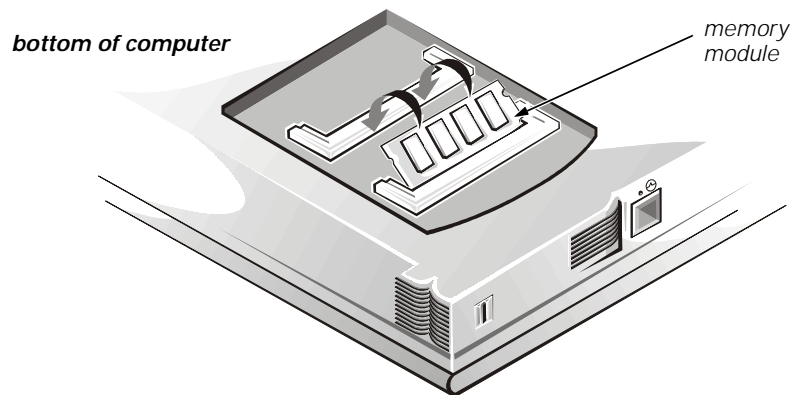

**Figure 3-9. Installing a Memory Module**

8. Replace the memory module cover.
9. Reboot the computer, and press <F2> when prompted to enter the Setup program.
10. In the **Main** menu of the Setup Program, make sure that the value in the **Extended Memory** field is at least 15 MB.

**Yes.** A memory module was loose; the memory check phase is complete.

**No.** Go to step 11.

11. Call Dell for technical assistance.

See Chapter 5, "Getting Help," for instructions.

## **Troubleshooting the Display**

If the computer is receiving power, but nothing appears on your display (such as light, text, or graphics) or the display image does not appear as you would expect, make a copy of the Diagnostics Checklist found in Chapter 5 and fill it out as you complete the following procedure.



*NOTE: A 13.3-inch and a 14.1-inch extended graphics array (XGA) display supports 1024 x 768 pixels. If your application program uses a higher resolution, you must attach an external video graphics array (VGA) monitor to your computer.*

1. If the computer is running, press any key on the integrated keyboard. Is the full display readable?

**Yes.** The computer was in standby or suspend mode. The problem is resolved.

**No.** Go to step 2.

2. Is an external monitor connected to the computer?

**Yes.** Go to step 3.

**No.** Go to step 4.

3. Press the <Fn><F8> key combination. Is the full display readable?

**Yes.** The **Video Mode** option in the Setup program was set to **CRT Mode**.

**No.** Go to step 4.

4. Turn off the computer and any attached peripherals. Disconnect all peripherals from the computer.

5. Make sure the AC adapter is firmly connected to the computer and to an AC power source, or verify that a fully charged battery is properly seated in its compartment.

6. Turn on the computer. Is the display on?  
Allow one minute for the computer to initialize its components.  
**Yes.** Go to step 7.  
**No.** Go to step 9.
7. Use the <Fn> down-arrow or <Fn> up-arrow key combination to adjust the brightness. Is the full display readable?  
**Yes.** Go to step 8.  
**No.** Go to step 9.
8. Has an error message appeared on the display, or has a beep code sounded?  
**Yes.** Refer to Table 3-2 or Table 3-3 to find the message or beep code, respectively, along with its explanation. If you can't find the message or code, call Dell for technical assistance. (See Chapter 5, "Getting Help," for instructions.)  
**No.** If you still have a display problem but the display is not completely blank, run the Video test group in the Dell Diagnostics. Then call Dell for technical assistance. (See Chapter 5, "Getting Help," for instructions.)
9. Turn off your computer and connect an external monitor to the computer.
10. Turn on the computer and the monitor and adjust the monitor's brightness and contrast controls. Is the monitor readable?  
**Yes.** The computer's display may be defective. Call Dell for technical assistance. (See Chapter 5, "Getting Help," for instructions.)  
**No.** The computer's video controller on the system board may be defective. Call Dell for technical assistance. (See Chapter 5, "Getting Help," for instructions.)

## **Troubleshooting an External Monitor**

During POST, the computer checks to see if an external monitor is attached to the computer. If no image appears on the external monitor when the computer boots, make a copy of the Diagnostics Checklist found in Chapter 5 and fill it out as you complete the following procedure:

1. Is the **Video Display Device** option in the Setup program set to LCD Mode?  
**Yes.** If the **Video Display Device** option is set to **LCD Mode**, the computer ignores the presence of an external monitor at start-up. Go to step 2.  
**No.** Go to step 2.
2. Press the <Fn><F8> key combination on the integrated keyboard several times. Does an image appear on the external monitor?  
**Yes.** The problem is resolved.  
**No.** Go to step 3.

3. Make sure the external monitor's video cable is firmly connected to the computer's external monitor connector, and then verify that the monitor's power cable (if it has one) is firmly plugged into an AC power source. Make sure the monitor is turned on.
4. Check the monitor cable for bent pins.
5. Turn off the computer, wait a minute, and then turn the computer back on. Adjust the monitor's brightness and contrast controls. Is the monitor readable?

Allow one minute for the computer to initialize its components.

**Yes.** The problem is resolved.

**No.** Go to step 6.

6. Raise your computer's display into viewing position, if necessary, and press <Fn><F8> to switch the video image from the external monitor to the display.
7. Use the <Fn> down-arrow or <Fn> up-arrow key combination to adjust the brightness. Is the full display readable?

**Yes.** The external monitor may be defective. Go to step 8.

**No.** The video controller on the system board may be defective. Call Dell for technical assistance. (See Chapter 5, "Getting Help," for instructions.)

8. Turn off the computer and any attached peripherals. Disconnect all peripherals from the computer. Attach another external monitor to the computer.

If you do not have another external monitor, call Dell for technical assistance. (See Chapter 5, "Getting Help," for instructions.)

9. Reboot the computer, and adjust the monitor's brightness and contrast. Is the monitor readable?

Allow one minute for the computer to initialize its components.

**Yes.** The original monitor is defective. Call Dell for technical assistance. (See Chapter 5, "Getting Help," for instructions.)

**No.** Call Dell for technical assistance. (See Chapter 5, "Getting Help," for instructions.)

## **Troubleshooting the Serial and Parallel Ports**

This section provides a procedure for troubleshooting the computer's serial and parallel ports (shown in Figure 3-4) and any attached peripheral devices.

If a system error message indicates a port problem or if equipment connected to a port seems to perform incorrectly or not at all, the source of the problem may be any of the following:

- A faulty connection between the I/O port and the peripheral device
- Incorrect settings for system setup options

- Incorrect settings in the operating system's configuration files
- A faulty cable between the I/O port and the peripheral device
- A faulty peripheral device
- Faulty I/O port logic on the system board
- Conflicting COM port settings
- Lack of drivers

### *Troubleshooting the Basic I/O Functions*

Make a copy of the Diagnostics Checklist found in Chapter 5, and fill it out as you complete the following procedure:

1. Check the settings for the **Serial Port** and **Parallel Port Mode** options in the **System Devices** menu of the Setup program.

For information on the Setup program, see Chapter 2, "Customizing System Features." Are the communication port options set correctly for the peripheral devices connected to the computer?

**Yes.** Go to step 3.

**No.** Go to step 2.

2. Change the **Serial Port** and **Parallel Port Mode** options to the appropriate settings, and then reboot the system.

Is the problem resolved?

**Yes.** The problem is resolved.

**No.** Go to step 3.

3. Check the contents of your initialization and start-up files. (See "Installing and Configuring Software" found earlier in this chapter.)

Are the port configuration commands correct?

**Yes.** Go to step 5.

**No.** Go to step 4.

4. Change the necessary statements in the start-up files.

If the port problem is confined to a particular application program, see the application program's documentation for specific port configuration requirements.

Is the problem resolved?

**Yes.** The problem is resolved.

**No.** Go to step 5.

5. Insert your diagnostics diskette into drive A, reboot the computer, and run the Serial/Infrared Ports test group and/or the Parallel Ports test group in the Dell Diagnostics. (See Chapter 4, "Running the Dell Diagnostics.")

The Serial/Infrared Ports test group and the Parallel Ports test group check the basic functions of the system board's I/O port logic. Also, if a parallel printer is connected to the parallel port, the Parallel Ports test group tests the communication link between the system board's I/O port logic and the printer.

Do the tests complete successfully?

**Yes.** Go to step 6.

**No.** Call Dell for technical assistance. (See Chapter 5, "Getting Help," for instructions.)

6. If the problem persists, go to "Troubleshooting a Parallel Printer" or "Troubleshooting a Serial I/O Device" found later in this chapter.

### *Troubleshooting a Parallel Printer*

If the preceding procedure, "Troubleshooting the Basic I/O Functions," indicates that the problem is with a parallel printer, use the following procedure:

1. Turn off the parallel printer and computer.
2. Swap the parallel printer's interface cable with a known working cable.
3. Turn on the parallel printer and computer.
4. Attempt a print operation on the parallel printer.

Does the print operation complete successfully?

**Yes.** You probably need a new interface cable. Call Dell for technical assistance. (See Chapter 5, "Getting Help," for instructions.)

**No.** Go to step 5.

5. Run the parallel printer's self-test.

Does the self-test complete successfully?

**Yes.** Go to step 6.

**No.** The printer is probably defective. If you bought the printer from Dell, call Dell for technical assistance. (See Chapter 5, "Getting Help," for instructions.) If you purchased the printer elsewhere, take it to one of the manufacturer's authorized service centers for repair.

6. Attempt another print operation on the parallel printer.

Does the print operation complete successfully?

**Yes.** The problem is resolved.

**No.** Call Dell for technical assistance. (See Chapter 5, "Getting Help," for instructions.)

### ***Troubleshooting a Serial I/O Device***

If the procedure titled "Troubleshooting the Basic I/O Functions" found earlier in this section indicates that the problem is with a device connected to one of the serial ports, use the following procedure:

1. Save any open application programs, and then turn off the computer and the serial device.
2. Swap the device's interface cable with a known working cable.
3. Turn on the computer and the serial device.

Is the problem resolved?

**Yes.** You probably need a new interface cable. Call Dell for technical assistance. (See Chapter 5, "Getting Help," for instructions.)

**No.** Go to step 4.

4. Turn off the computer and the serial device and swap the device with a comparable working device.

For example, if your serial mouse has a problem, swap it with a serial mouse you know is working properly.

5. Turn on the computer and the serial device.

Is the problem resolved?

**Yes.** You probably need a new device. Call Dell for technical assistance. (See Chapter 5, "Getting Help," for instructions.)

**No.** Call Dell for technical assistance. (See Chapter 5, "Getting Help," for instructions.)

## ***Troubleshooting the Infrared Port***

This section provides a procedure for troubleshooting the computer's infrared (IR) port.

Make a copy of the Diagnostics Checklist found in Chapter 5 and fill it out as you complete the following procedure:

1. Check the setting for the **Infrared Port** option in the **System Devices** menu of the Setup program.

For information on the Setup program, see Chapter 2, "Customizing System Features." Is the Infrared option set correctly for the external device with which you are communicating?

**Yes.** Go to step 3.

**No.** Go to step 2.

2. Change the **Infrared Port** option to the appropriate setting, and then reboot the system.

Is the problem resolved?

**Yes.** The problem is resolved.

**No.** Go to step 3.

3. Insert your diagnostics diskette into drive A, reboot the computer, and run the Serial/Infrared Ports test group in the Dell Diagnostics. (See Chapter 4, "Running the Dell Diagnostics.") The Serial/Infrared Ports test group checks the basic functions of the computer's infrared logic.

4. Do the tests complete successfully?

**Yes.** The infrared port is functioning properly. There may be a problem with the infrared application program or with the external device. Check the documentation that came with the application program and with the external device.

**No.** Call Dell for technical assistance. (See Chapter 5, "Getting Help," for instructions.)

## ***Troubleshooting the Touch Pad***

This section provides a procedure for troubleshooting the computer's touch pad.

Make a copy of the Diagnostics Checklist found in Chapter 5 and fill it out as you complete the following procedure:

1. Check the setting for the **PS/2 Mouse** option in the **System Devices** menu of the Setup program.

For information on the Setup program, see Chapter 2, "Customizing System Features." Is the **PS/2 Mouse** option set to **Enabled**?

**Yes.** Go to step 3.

**No.** Go to step 2.



2. Change the **PS/2 Mouse** option to **Enabled**, and then reboot the system. Does the touch pad work properly?

**Yes.** The problem is resolved.

**No.** Go to step 3.

3. Insert your diagnostics diskette into drive A, reboot the computer, and run the Mouse Test in the Dell Diagnostics. (See Chapter 4, "Running the Dell Diagnostics.") The Mouse test checks the functionality of the mouse controller (which affects the ability to move the pointer around the screen) and the operation of the touch pad buttons.
4. Do the tests complete successfully?

**Yes.** The controller is functioning properly. If the problem persists, call Dell for technical assistance. (See Chapter 5, "Getting Help," for instructions.)

**No.** Call Dell for technical assistance. (See Chapter 5, "Getting Help," for instructions.)

## **Troubleshooting Audio Functions**

This section provides a procedure for troubleshooting the computer's sound functions.

1. Make a copy of the Diagnostics Checklist found in Chapter 5 and fill it out as you complete the following procedure:
2. Insert your diagnostics diskette into drive A, reboot the computer, and run the Audio test group in the Dell Diagnostics. (See Chapter 4, "Running the Dell Diagnostics.") The Audio test group checks the functionality of the audio controller.
3. Do the tests complete successfully?

**Yes.** The controller is functioning properly. If the problem persists, call Dell for technical assistance. (See Chapter 5, "Getting Help," for instructions.)

**No.** Call Dell for technical assistance. (See Chapter 5, "Getting Help," for instructions.)



# CHAPTER 4

## Running the Dell Diagnostics

Unlike many diagnostic programs, the Dell Diagnostics allows you to check the computer's hardware without any additional equipment and without destroying any data. By using the Dell Diagnostics, you can have confidence in the computer's operation. If you find a problem you cannot solve by yourself, the Dell diagnostic tests can provide you with important information you will need when talking to Dell's service and support personnel.



**CAUTION:** Use the Dell Diagnostics to test *only* your Dell computer. Using this program with other computers may cause incorrect computer responses or result in misleading error messages.



*NOTE:* If the computer does not boot, call Dell for technical assistance. See Chapter 5, "Getting Help," for instructions.

### Features of the Dell Diagnostics

To troubleshoot components or devices, run the appropriate test (test group or subtest) in the diagnostics on your *Dell Diagnostics Diskette*. The diagnostics program exercises the functional components and devices of the computer more vigorously and thoroughly than they are exercised during normal operation.

The Dell Diagnostics provides a series of menus and options from which you choose particular test groups or subtests. Each diagnostic test group or subtest allows you to control important testing parameters. You can also control the sequence in which the tests are run. The diagnostic test groups or subtests also have these helpful features:

- Options that let you run tests individually or collectively
- An option that allows you to choose the number of times a test group or subtest is repeated
- The ability to display test results, print them, or save them in a file
- Options to suspend testing when an adjustable error limit is reached
- A menu option called **About** that briefly describes each test and its parameters
- Status messages that inform you whether test groups or subtests were completed successfully
- Error messages that appear if any problems are detected

## When to Use the Dell Diagnostics

Whenever a major component or device in the computer does not function properly, the component or device may have failed. As long as the microprocessor and input/output (I/O) components of the computer (the display, keyboard, and diskette drive) are working, use the Dell Diagnostics. If you are experienced with computers and know what component(s) you need to test, select the appropriate diagnostic test group(s) or subtest(s). If you are unsure about how to begin diagnosing a problem, read the rest of this chapter.

## Before You Start Testing

Follow these steps to safeguard your master copy of the *Dell Diagnostics Diskette*:

1. Make a working copy of the *Dell Diagnostics Diskette* on a blank diskette.

Refer to your operating system's documentation for information on how to duplicate diskettes. Put the original diskette away for safekeeping.

2. Disconnect any attached printers.
3. Set default values in the Setup program.

- a. In the **Exit** menu, choose **Get Default Values**.
- b. Choose **Yes** when prompted to load the default configuration.

For additional instructions, see the topic titled "Setup Program" in the *System User's Guide*.

4. In the Setup program, confirm the following settings in the **System Devices** menu:

**Serial Port = [Auto]**  
**Infrared Port = [Auto]**  
**Parallel Port = [Auto]**  
**Audio = [Enabled]**  
**1st DMA Channel = [DMA 1]**  
**2nd DMA Channel = [DMA 3]**

5. In the **Power** menu of the Setup program, confirm that the **Power Management Mode** option is set to **Disabled**.
6. Press <F10> to save the settings and exit the Setup program.
7. Attach an AC adapter to the computer.

Although it is possible to run the Dell Diagnostics on a computer using battery power, connecting the computer to AC power helps ensure that power will not be lost during the tests.

## Starting the Dell Diagnostics

After you complete the preliminary instructions specified in the previous section, follow these steps to start the diagnostics:

1. Install a combination module in the options bay.
2. Turn off the computer.
3. Place the *Dell Diagnostics Diskette* in the diskette drive and boot the computer.



*NOTE: Before you read the rest of this chapter, you may want to start the Dell Diagnostics so you can see the menus on your display.*

When you start the diagnostics, the Dell logo screen appears, and a program tests the random-access memory (RAM) that will be used by the diagnostics.

If a failure in RAM is detected, a message appears on the screen telling you the memory address of the defective memory module. Write down the memory address and see Chapter 5, "Getting Help," for instructions on obtaining technical assistance.

If no errors are found in RAM, the diagnostics loads and the **Diagnostics Menu** appears (see Figure 4-1). The menu allows you to exit to the MS-DOS prompt.

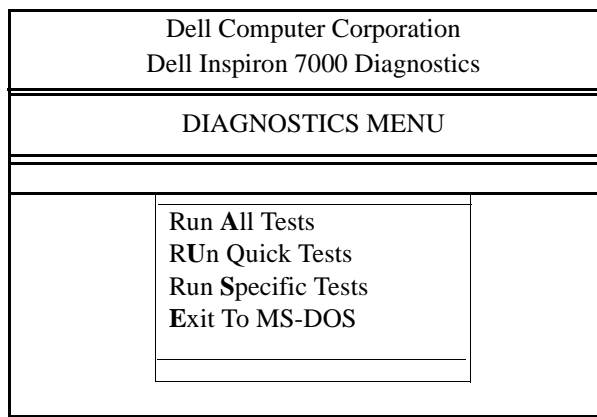

**Figure 4-1. Diagnostics Menu**

For a quick check of your system, select the **Run Quick Tests** option. This option runs only the subtests that do not require user interaction and that do not take a long time to run. Dell recommends that you choose this option first to increase the odds of tracing the source of the problem quickly. For a complete check of your system, select the **Run All Tests** option. To check a particular area of your system, select the **Run Specific Tests** option.

## Completing the Dell Diagnostics

After you complete the Dell Diagnostics, use the Setup program to restore the computer's previous configuration.

In the **Exit** menu of the Setup program, select **Reset to Factory Default Values** or **Reset to Previous Values**.

Selecting **Reset to Factory Default Values** restores the Setup configuration to its original state. Selecting **Reset to Previous Values** restores the last user-specified configuration.

## How to Use the Dell Diagnostics



**CAUTION: While the diagnostic tests are running, do not interrupt the tests, do not unplug the AC adapter (or plug one in if you are running the tests from battery power), and do not reboot the computer. Interrupting the tests in any of these ways could lead to the loss of system data.**

When you select **Run All Tests** or **Run Specific Tests** from the **Diagnostics Menu**, the main screen of the diagnostics appears (see Figure 4-2). The main screen lists the diagnostic test groups, gives information about the configuration of the computer, and allows you to select options from a menu.

To select an option from the **Diagnostics Menu**, highlight the option and press <Enter>, or press the key that corresponds to the highlighted letter in the option.

Information on the main screen of the diagnostics is presented in the following four areas:

- Two lines at the top of the screen identify the diagnostics and give its version number.
- On the left side of the screen, the **Available** test groups area lists the diagnostic test groups in the order they will be run if you select the **Run** menu option and then the **All** menu option. Press the up- or down-arrow key to highlight a test group.
- On the right side of the screen, the **System Configuration** area lists the computer's current hardware settings.
- At the bottom of the screen is the menu area. The first line lists the options you can select; press the left- or right-arrow key to highlight a menu option. The second line gives information about the option currently highlighted.

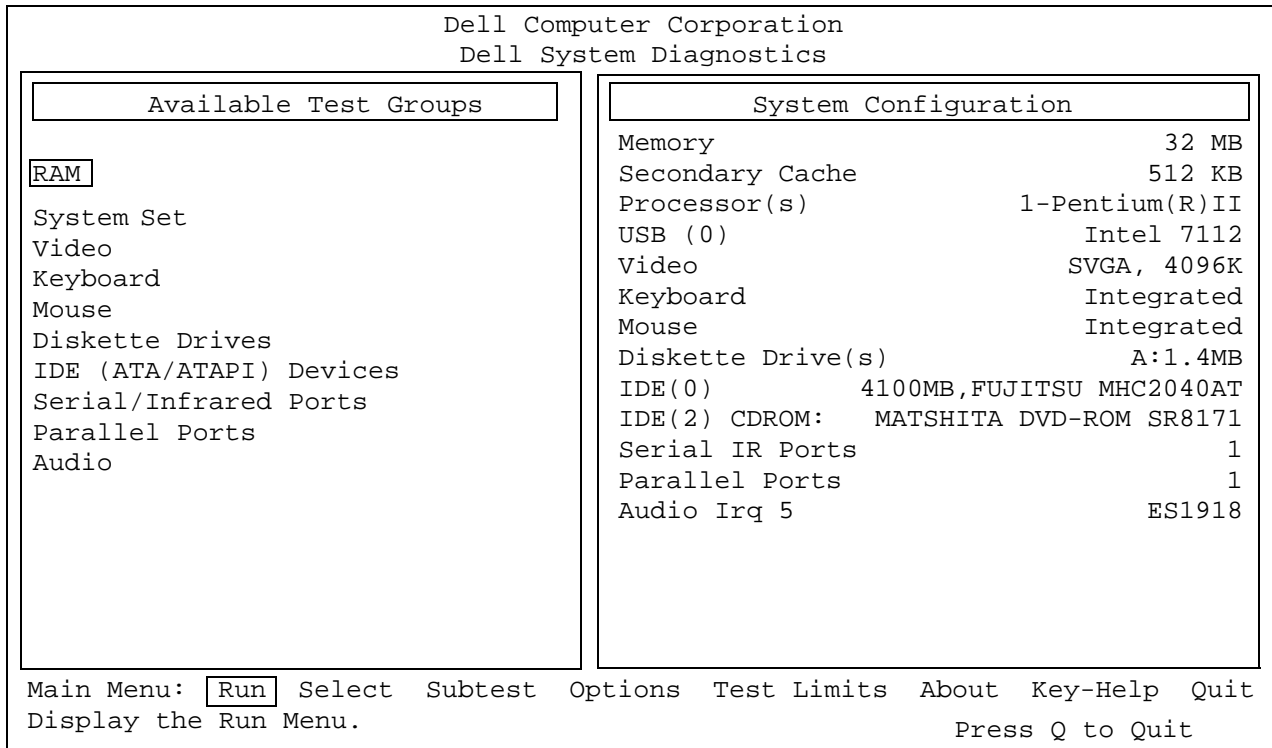

*NOTE: The options displayed on your screen reflect the hardware configuration of the computer system.*

**Figure 4-2. Main Screen of the Dell Diagnostics**

## **Confirming the System Configuration Information**

When you boot the computer from your diagnostics diskette, the diagnostics checks your system configuration information and displays it in the **System Configuration** area on the main screen.

The following sources supply this configuration information for the diagnostics:

- The system configuration information that you selected through the Setup program options
- Identification tests of the microprocessor, the video controller, the keyboard controller, and other key components
- Basic input/output system (BIOS) configuration information temporarily saved in RAM

Do not be concerned if the **System Configuration** area does not list the names of all the components or devices you know are part of the computer. For example, you may not see a printer listed, although you know one is attached to the computer. Instead, the printer is listed as a parallel port. The computer recognizes the parallel port as LPT1, which is an address that tells the computer where to send outgoing information and where to look for incoming information. Because your printer is a parallel communications device, the computer recognizes the printer by its LPT1 address and identifies it as a parallel port.

## How to Use the Menu

One of the menu options is already highlighted at the bottom of the screen. You can move the highlighting from one option to another by pressing the left- or right-arrow key. As you move from one menu option to another, a brief explanation of the currently highlighted option appears on the bottom line of the screen.

If you want more information about a test group or subtest, move the highlight to the **About** option and press <Enter>. After reading the information, press <Esc> to return to the previous screen.

## Main Menu Options

The **Main** menu of the diagnostics main screen lists eight options: **Run**, **Select**, **Subtest**, **Options**, **Test Limits**, **About**, **Key-Help**, and **Quit**.



*NOTE: Before running any test groups or subtests (by selecting **Run** and then **All**), you should consider setting global parameters within the **Options** option. They offer you greater control over how the test groups or subtests are run and how their results are reported.*

There are two ways to select a menu option:

- Type the capitalized letter in the option (for example, type **r** to select the **Run** option).
- Use the left- or right-arrow key to highlight the option, and then press <Enter>.

Whenever one of the eight options is selected, additional choices become available.

The following subsections explain the menu options as listed from left to right in the **Main** menu.

### Run

**Run** displays five options: **One**, **Selected**, **All**, **Key-Help**, and **Quit Menu**. If you select **One**, only the highlighted test group is run. If you choose **Selected**, the computer runs the test groups, or the selected subtests within the test groups that you selected. (Select test groups or subtests within test groups with the **Select** or **Subtest** options, as described in the following subsections.) If you select **All**, all of the subtests in all of the test groups are run. (The test groups or subtests are run in the order they are listed.)

The **Key-Help** option displays a list of key controls available for the selected option. The **Quit Menu** option returns you to the **Main** menu.

## **Select**

**Select** allows you to select individual test groups to tailor the testing process to your particular needs. You can choose one or more test groups and run them sequentially or individually. When you choose **Select**, five options are displayed: **All**, **One**, **Clear All**, **Key-Help**, and **Quit Menu**.

To select all the test groups, highlight **All** in the **Select** menu, and press <Enter>. To select an individual test group, either press the up- or down-arrow key to highlight the test group and press the <Spacebar>, or highlight **One** in the **Select** menu and press <Enter>.

To reverse a test group selection, highlight the test group and press the <Spacebar>. To clear all selected test groups, select **Clear All**.

The **Key-Help** option displays a list of key controls available for the selected option. The **Quit Menu** option returns you to the **Main** menu.

## **Subtest**

Most of the test groups consist of several subtests. Use the **Subtest** option to select individual subtests within the test group(s).

When you select **Subtest**, many of the same options as those on the **Main** menu are displayed: **Run**, **Select**, **Options**, **Test Limits**, **About**, **Key-Help**, and **Quit Menu**. Each of these options is explained in the following subsections.

### *Run (Under Subtest)*

**Run** in the Subtest menu displays five options: **One**, **Selected**, **All**, **Key-Help**, and **Quit Menu**. If you select **One**, only the highlighted subtest is run. If you choose **Selected**, only the selected subtests are run. If you select **All**, every subtest in the selected test group is run. (The subtests are run in the order they are listed.)

The **Key-Help** option displays a list of available key controls. The **Quit Menu** option returns you to the previous menu.

### *Select (Under Subtest)*

**Select** in the **Subtest** menu allows you to select individual subtests to tailor the testing process to your particular needs. You can choose one or more subtests from the list. When you choose **Select**, five options are displayed: **All**, **One**, **Clear All**, **Key-Help**, and **Quit Menu**.

To select all the test groups, highlight **All** in the **Select** menu, and then press <Enter>. To select an individual subtest, either highlight the subtest and press the <Spacebar> or highlight **One** and press <Enter>.

To reverse a subtest selection, highlight the subtest and press the <Spacebar>. To clear all selected subtests, select **Clear All**.

The **Key-Help** option displays a list of available key controls. The **Quit Menu** option returns you to the previous menu.



### *Options (Under Subtest)*

The **Options** option in the **Subtest** menu functions in the same manner as the **Options** option in the **Main** menu. For information on this option, see “Options” found later in this section.

### *Test Limits (Under Subtest)*

The **Test Limits** option in the **Subtest** menu functions in the same manner as the **Test Limits** option in the **Main** menu. For information on this option, see “Test Limits” found later in this section.

### *About (Under Subtest)*

The **About** option in the **Subtest** menu displays information about the highlighted subtest, such as its limits and parameters and how to set them.

### *Key-Help (Under Subtest)*

The **Key-Help** option in the **Subtest** menu displays a list of available key controls.

### *Quit Menu (Under Subtest)*

The **Quit Menu** option in the **Subtest** menu returns you to the **Main** menu.

## **Options**

Table 4-1 lists all possible values for each global parameter of **Options**. A brief description of each parameter follows the table. To select a parameter, press the up- or down-arrow key. To change the values within fields, use the left- or right-arrow key, the <Spacebar> key, or the plus (+) and minus (-) keys. If the value within a field is numeric, you can type in the number. (If you make a mistake, type in zeros until the field is filled with zeros and then start again.)

**Table 4-1. Option Parameters**

<b>Option Limit</b>	<b>Possible Values</b>
Number of Times to Repeat Test(s)	0001 through 9999, or 0000, which loops indefinitely until you press the <Ctrl> and <Break> keys. The default is <b>0001</b> .
Maximum Errors Allowed	0000 through 9999, where 0000 means that there is no error limit. The default is <b>0001</b> .
Pause for User Response	<b>Yes, No</b> Allows you to decide whether tests will wait for user input. The default is <b>Yes</b> (to wait for user input).
Output Device for Status Messages	<b>Display, Printer, File</b> If you have a printer attached to the computer, you can use it to print the <i>status</i> messages, if any, that are generated when a test runs. (The printer must be turned on and in the online mode to print.) If you select <b>File</b> , the status messages are printed to a file named <b>result</b> on the diagnostics diskette. The default is <b>Display</b> .
Output Device for Error Messages	<b>Display, Printer, File</b> If you have a printer attached to the computer, you can use it to print the <i>error</i> messages, if any, that are generated when a test runs. (The printer must be turned on and in the online mode to print.) If you select <b>File</b> , the error messages are printed to a file named <b>result</b> on the diagnostics diskette. The default is <b>Display</b> .

### *Number of Times to Repeat Test(s)*

This parameter specifies the number of times the tests run when you select **Run**. To change the default, type in the desired value. If you type 0 (zero), the test is run until you press <Ctrl><Break>.

### *Maximum Errors Allowed*

This parameter specifies the maximum number of errors that can occur before testing is suspended. The error count begins from zero each time you run a subtest or test group individually or each time you select **All** to run all of them. To change the default, type in the desired value. If you type 0 (zero), testing continues, regardless of the number of errors found, until you press <Ctrl><Break>.

### *Pause for User Response*

If this parameter is set to **Yes**, the diagnostics pauses when one of the following occurs:

- Your interaction is needed to verify the Video test group screens, the Keyboard test group key functions, or other types of interaction such as inserting a diskette.
- The maximum error limit is reached.

To continue testing, press any key.

If the **Pause for User Response** parameter is set to **No**, the diagnostics ignores subtests that require your interaction; certain subtests can run only if this option is set to **Yes** because they require user interaction. Set this parameter to **No** when you want to bypass subtests that require user interaction—such as when you run the diagnostics overnight.

### *Output Device for Status Messages*

Ordinarily, all status messages appear only on the display. This parameter allows you to direct status messages to either a printer or a file, in addition to the display. Use the right-arrow key to select the option you want. If you choose the **Printer** option, status messages print as they occur. If you choose the **File** option, status messages are written to a file named **result**. This file is automatically created on the diagnostics diskette when you run the diagnostics. If the **result** file already exists on the diskette, new status messages are added to it.

The **result** file is an ordinary American Standard Code for Information Interchange (ASCII) text file. You can access the **result** file through Windows Notepad with the following steps:

1. Select **Quit** to exit the diagnostics and return to the MS-DOS prompt.
2. Remove the *Dell Diagnostics Diskette* from the diskette drive.
3. Use the <Ctrl><Alt><Del> key combination to reboot the computer.
4. If necessary, start the operating system.
5. Insert the *Dell Diagnostics Diskette* into the diskette drive.
6. Double-click the **Notepad** icon. Then select **Open** from the **File** menu.
7. In the **File Name** text box, type `a:\result` and press <Enter>.

The contents of the file appear on the display.

You can also access the **result** file with the MS-DOS **type** command:

1. Select **Quit** to exit the diagnostics and return to the operating system prompt.
2. At the operating system prompt, type the following command and press <Enter>:

```
type result
```

The contents of the file appear on the display.

After running particular diagnostic tests and viewing the status messages generated by the tests in the **result** file, you can delete the contents of the file so that it is empty for the next set of messages generated. Otherwise, the next messages are added to the end of the previous ones in the file.

## Output Device for Error Messages

Ordinarily, all error messages appear only on the display. This parameter allows you to direct error messages to either a printer or a file, in addition to the display. Use the right-arrow key to select the option you want. If you choose the **Printer** option, error messages print as they occur. If you choose the **File** option, error messages are written to the **result** file used for status messages. This file is automatically created on your diagnostics diskette when you run the diagnostics. If the **result** file already exists on the diskette, new error messages are added to it.

The **result** file is an ordinary ASCII text file. You can access and review the **result** file in Windows Notepad or with the MS-DOS **type** command as described in the previous subsection, "Output Device for Status Messages."

After running particular diagnostic tests and viewing the error messages generated by the tests in the **result** file, you can delete the contents of the file so that it is clear for the next set of messages generated. Otherwise, the next messages are added to the end of the previous ones in the file.

## Test Limits



*NOTE: The diagnostics program sets default limits on all tests. The only reason to change the defaults would be to limit the amount of testing done. An exception is the default limit for testing super video graphics array (SVGA) modes. If you are testing an external monitor, change the default to **Yes**.*

The RAM test group, the Video test group, the Serial/Infrared Ports test group, the Diskette Drives test group, the Parallel Ports test group, and the Hard-Disk Drives (Non-SCSI) test group allow you to designate limits. Whether you select **Test Limits** for a highlighted test group (from the **Main** menu) or a subtest (from the **Subtest** menu), you set the limits for all the subtests in that test group. When you select **Test Limits**, a new screen appears and the **Key-Help** area lists keys to use with the new screen.

How you change a value for the limits of a test group or subtest depends on the type of parameter associated with it. Different keys are used to change values for different types of parameters. For example, memory address limits specified for the RAM test group are changed by typing in numbers over the digits of a given limit or by pressing the plus (+) or minus (-) key to increase or decrease the given limit. In contrast, to set limits for the Serial Ports test group, use the <Spacebar> to toggle between **Yes** and **No**.

After you are satisfied with the limits, return to the main screen of the diagnostics by pressing the <Esc> key. The values you selected under **Test Limits** remain in effect until you change them or exit the diagnostics. The values are reset to their defaults when you restart the diagnostics.

Press <Page Down> to select the next menu for the test limits in a category.

## About

**About** in the **Main** menu displays information about the highlighted test group, such as limits and parameters and how to set them.

## Key-Help

**Key-Help** displays a list of key controls available for the selected option.

## Quit



**CAUTION: It is important that you quit the diagnostics program correctly, because the program writes data to the computer's memory that can cause problems unless properly cleared.**

Select **Quit** from the **Main** menu to exit the diagnostics and return to an MS-DOS prompt. Remove your diagnostics diskette from drive A and reboot the computer by pressing <Ctrl><Alt><Del>.

## Tests in the Dell Diagnostics

The diagnostics is organized by components into test groups and subtests within each test group. Each subtest is designed to detect any errors that may interfere with the normal operation of a specific device of the computer.



*NOTE: Any subtest requiring hardware not listed in the **System Configuration** area appears to run, but the subtest concludes with a status message stating Component not available.*

Table 4-2 lists the diagnostic test groups, their subtests, and comments concerning their use.

**Table 4-2. Dell Diagnostics Tests**

Test Groups	Subtests	Description
RAM	Quick Test Comprehensive Test Cache RAM Test	Tests the RAM.
System Set	CMOS Confidence Test DMA Controller Test Real-Time Clock Test Timers Test System Speaker Test	Tests the system board's support chips, DMA controller, computer timer, NVRAM, speaker controller, and, if appropriate, the external cache and the thermal-control device.
	Coprocessor Calculation Test Coprocessor Error Exception Test	Tests the math coprocessor that is internal to the microprocessor.
	PCMCIA Test	Tests the PC Card controller on the system board.
	USB Registers Test USB Memory Structure Test	Checks the built-in registers of the USB interface. This subtest does not test USB peripherals.
	Temperature Range Test Fan On/Off Test	Tests thermal ranges.
	Battery Charger Test	Tests the battery charger.
Video	Video Memory Test Video Hardware Test Text Mode Character Test Text Mode Color Test Text Mode Pages Test Graphics Mode Test Color Palettes Test Solid Colors Test	Tests the monitor by checking various aspects of video output.
Keyboard	Keyboard Controller Test Keyboard Key Sequence Test Keyboard Interactive Test Stuck Key Test	Tests the keyboard by checking the keyboard controller and by finding keys that <i>stick</i> or respond incorrectly.
Mouse	Mouse Test	Tests the electronic pointing device (integrated touch pad, external serial or PS/2 mouse).
Diskette Drives	Change Line Test Seek Test Read Test Write Test	Tests a drive that uses removable diskettes. Also tests the associated controlling devices and important parts of the cabling.

NOTE: For the full name of an abbreviation or acronym used in this table, see the Glossary in the System User's Guide.

**Table 4-2. Dell Diagnostics Tests** (continued)

Test Groups	Subtests	Description
IDE (ATA/ATAPI) Devices Test Group	Display Information Self Diagnostics Test Seek Test Read Test Verify Test Write Test Media Eject Test Audio Test	Tests a drive that uses fixed, internal disks. Also tests the associated controlling devices.
Serial/Infrared Ports	Serial/Infrared Baud Rate Test Serial/Infrared Interrupt Test Serial/Infrared Internal Transmission Test	Tests the components through which peripherals that use the serial or infrared port, such as communications devices, send and receive data.
Parallel Ports	Parallel Internal Test Parallel External Interrupt Test Parallel Printer Pattern Test	Tests the components through which peripherals that use the parallel port, such as printers, send and receive data.
Audio	M2 Timer Test M2 IRQ Channel Test M2 Sigma RAMTest M2 Control RAM Test M2 WaveCache Test	Tests the operation of the audio chip set.

NOTE: For the full name of an abbreviation or acronym used in this table, see the Glossary in the System User's Guide.

## Error Messages

When you run a test group or subtest in the diagnostics, error messages may result. These particular error messages are not covered in this guide because the errors that generate these messages can be resolved only with a technician's assistance. Record the messages on a copy of the Diagnostics Checklist found in Chapter 5, and then read that chapter for instructions on obtaining technical assistance.

## RAM Test Group

The RAM test group subtests check all the directly addressable RAM.

### Why Run a RAM Test?

Faulty memory can cause a variety of problems that may not, at first glance, appear to be happening in RAM. If the computer is displaying one or more of the following symptoms, run both the subtests in the RAM test group to verify that the memory is not at fault:

- A program is not running as usual, or a proven piece of software appears to malfunction and you confirm that the software itself is not at fault. (You can confirm

that the software is functioning properly by moving it to another computer and running it there.)

- The computer periodically locks up (becomes unusable and must be rebooted), especially at different places and times in different programs.

## **Subtests**

Three subtests are available for RAM: the Quick Test, the Comprehensive Test and the Cache RAM Test. The Quick Test performs an address check to determine whether the computer is properly setting and clearing individual bits in RAM, and whether the RAM read and write operations are affecting more than one memory address location at one time. This subtest checks all available RAM. The Comprehensive Test also performs an address check, as well as the following checks:

- Data pattern checks, to look for RAM bits that are stuck high or low, short-circuited data lines, and some data pattern problems that are internal to the memory chips
- A parity check that verifies the ability of the memory subsystem to detect errors
- A refresh check, to verify that the dynamic RAM (DRAM) is being recharged properly
- The Cache RAM Test checks that the system's cache RAM is functioning properly.

## **System Set Test Group**

The subtests in the System Set test group check the computer's basic system board components and verify their related functions.

### **Why Run a System Set Test?**

The System Set subtests double-check many system board components, such as the computer's I/O circuitry, that are tested by other test groups or subtests in the diagnostics. You should run the System Set test group if you are having a problem and cannot isolate the failure or malfunction to a particular system board component.

The System Set test group also verifies the proper operation of other computer components, such as the speaker, that are not tested elsewhere in the diagnostics.

The following symptoms usually suggest a problem with a component or subassembly that warrants running a System Set subtest:

- A program is not running as usual, or a proven piece of software appears to malfunction and you confirm that the software itself is not at fault. (You can confirm that the software is functioning properly by moving it to another computer and running it there.)
- A PC Card you previously accessed can no longer be accessed.
- The computer periodically locks up, especially at different places and times in different programs.



- Parity errors or page fault failures (any error message that contains the word parity or page fault) occur at any time during operation. These errors are usually accompanied by a reference to an address, which you should record on a copy of the Diagnostics Checklist found in Chapter 5.
- Correcting errors in the system configuration information does not resolve a problem.
- The computer's clock/calendar stops.
- The speaker no longer functions. The problem could be a failure of the system timers as well as a failure of the speaker itself. Run the System Timers Test, followed by the System Speaker Test.
- If a peripheral device appears to malfunction, run the Interrupt Controllers Test. If the computer fails the test, the problem lies with the interrupt controller; if the computer passes, then the problem lies with the peripheral device.
- A spreadsheet program or other type of mathematical application runs abnormally slow, generates error messages concerning calculations or operations, runs incorrectly, or generates incorrect results; or a proven piece of the program appears to malfunction and you confirm that the software itself is not at fault. (You can confirm that the software is not at fault by moving the program to another computer and running it there.)
- The computer halts in the middle of performing calculations or complex mathematical operations.

## **Subtests**

The subtests that constitute the System Set test group and the computer functions they confirm follow:

- **CMOS Confidence Test**  
Checks the nonvolatile RAM (NVRAM) for accessibility and reliability of data storage by performing a data pattern check and verifying the uniqueness of memory addresses.
- **DMA Controller Test**  
Tests the direct memory access (DMA) controller and verifies the correct operation of its page and channel registers by writing patterns to the registers.
- **Real-Time Clock Test**  
Confirms the functionality and accuracy of the computer's real-time clock (RTC).
- **Timers Test**  
Checks the timers used by the microprocessor for event counting, frequency generation, and other functions. Only the functions that can be activated by software are tested.

- **Interrupt Controller Test**  
Generates an interrupt on each interrupt request (IRQ) line to verify that devices using that line can communicate with the microprocessor and that the interrupt controller sends the correct memory addresses to the microprocessor.
- **System Speaker Test**  
Checks the functionality of the speaker by generating eight tones.
- **Coprocessor Calculation Test**  
Checks the use of different types of numbers and the math coprocessor's ability to calculate correctly.
- **Coprocessor Error Exception Test**  
Verifies the math coprocessor's ability to handle errors and to send IRQs to the microprocessor.
- **PCMCIA Test**  
Checks the functionality of the PC Card controller on the system board.
- **USB Register Test**  
Checks the onboard registers of the universal serial bus (USB) interface. This sub-test does not test USB peripherals.
- **USB Memory Structure Test**  
Tests the USB controller's ability to access and understand standard USB data in system memory.
- **Temperature Range Test**  
Verifies that the temperature sensor is within the minimum/maximum range and that the sensor can detect change.
- **Fan On/Off Test**  
Verifies the fan's cooling ability, and that it can be turned off and on.
- **Battery Charger Test**  
Verifies that the battery charger produces a voltage and that the battery holds a charge.

## **Video Test Group**

The subtests in the Video test group verify the proper operation of the video controller and the video control circuitry installed in the computer. These subtests check for the correct operation of the readable registers in the video circuitry and the controller. They write, read, and verify data patterns in the cursor registers of the controller. The

Video test group also provides additional subtests to test the color features of the color display or an external color monitor.



*NOTE: The video subsystem of your computer's display may support video resolutions that are not supported on an external monitor. When the video subtests are run on an external monitor, some of the test screens may flicker and appear to malfunction. This condition does not affect the accuracy of the video subtests or indicate a hardware problem.*

## **Why Run a Video Test?**

Many of the symptoms that would prompt you to run a subtest in the Video test group are obvious, because the display is the visual component of the computer. Before you run the Video test group or any of its subtests, you should make sure that the problem is not occurring in the software or caused by a hardware change.

If the following symptoms still occur, run the appropriate test(s) as follows:

- If your display or external monitor shows a partially formed or distorted image, run *all* of the subtests in the Video test group.
- If the alignment of text or images is *off*, regardless of the program you are running, run the Text Mode Character Test, Text Mode Pages Test, and Graphics Mode Test.
- If the color on the display or external monitor is intermittent or not displayed at all, run the Text Mode Color Test, Color Palettes Test, and Solid Colors Test.
- If your display or external monitor malfunctions in one mode but works fine in another (for example, text is displayed correctly, but graphics are not), run the Text Mode Character Test, Text Mode Color Test, Text Mode Pages Test, and Graphics Mode Test.

## **Subtests**

The eight subtests in the Video test group confirm the following video functions:

- Video Memory Test  
Checks the read/write capability of the video memory in various video modes.
- Video Hardware Test  
Checks the cursor registers and the horizontal and vertical retrace bit registers in the video controller.
- Text Mode Character Test  
Checks the video subsystem's ability to present data in text modes.
- Text Mode Color Test  
Checks the video subsystem's ability to present color in text modes.

- **Text Mode Pages Test**  
Checks the video subsystem's ability to map and present all available video pages on the screen, one page at a time.
- **Graphics Mode Test**  
Checks the video subsystem's ability to present data and color in graphics modes.
- **Color Palettes Test**  
Checks the video subsystem's ability to display all of the available colors.
- **Solid Colors Test**  
Checks the video subsystem's ability to show screens full of solid colors and allows you to check for missing color pixels.

Many of these tests display characters or graphics on the screen for you to verify. Samples of these screens are shown in Appendix B, "Diagnostic Video Tests."



*NOTE: The default for testing SVGA modes is **No**. If you are testing an external monitor, change the default to **Yes**.*

## **Keyboard Test Group**

The subtests in the Keyboard test group verify the correct operation of your keyboard and the keyboard controller chip.



*NOTE: If you test the <Fn> key, use either the Microsoft Windows logo or the menu keys near the spacebar when prompted to press the <----> key.*

### **Why Run a Keyboard Test?**

Keyboard problems are not always caused by the keyboard. For example, a complete lockup of the computer, rendering the keyboard inoperable, is probably not caused by a problem with the keyboard. There are two symptoms that are likely to be keyboard-related. Sometimes, the configuration of a program changes the function of a key or key combination. Similarly, key configuration programs like ProKey can change a key's function. Because these programs are memory resident, be sure to clear them out of the computer's memory before running a subtest in the Keyboard test group. (Clear them from memory by booting the computer from the *Dell Diagnostics Diskette*.)

When these possibilities have been eliminated, and if the following symptoms occur, you should run one or more of the subtests in the Keyboard test group:

- When you press a key, the character represented by that key appears repeatedly; the key seems to be stuck. Run the Stuck Key Test.
- When you press a key and the response is different from the usual response or the response you anticipated, the key contact may be damaged. Run the Keyboard Interactive Test.
- When a key does not work at all, run *all* of the subtests in the Keyboard test group.

## **Subtests**

The four keyboard subtests confirm the following keyboard functions:

- **Keyboard Controller Test**  
Confirms the ability of the keyboard controller chip to communicate with the keyboard and confirms the programming of the controller chip.
- **Keyboard Key Sequence Test**  
Verifies that the keys on the keyboard function correctly when you press them in a predefined order.
- **Keyboard Interactive Test**  
Checks the internal microcode of the keyboard and the external interface of the keyboard controller chip for a malfunctioning key.
- **Stuck Key Test**  
Checks the internal microcode of the keyboard and the external interface of the keyboard controller chip for a repeating key signal.

## **Mouse Test**

The Mouse test checks the functionality of the mouse controller (which affects the ability to move the touch pad/mouse pointer around the screen with its corresponding movement on your desk or pad) and the operation of the touch pad/mouse buttons.

### **Why Run the Mouse Test?**

Touch pad or mouse problems are as likely to be caused in RAM as they are to be caused by a faulty touch pad or mouse. Three sources of problems include the configuration of a program (which changes the function of the touch pad or mouse), memory-resident programs like Sidekick or ProKey, and failure of a device driver (the software that controls the functions of a touch pad or mouse). If these possibilities have been eliminated and the following symptoms persist, run the Mouse test:

- When you press a touch pad or mouse button, the function of the button continues; the button seems to be stuck.
- If the response when you press a touch pad or mouse button is different from the usual response or the response you anticipated, the button contact may be damaged.
- A touch pad or mouse button does not work at all.
- The cursor does not respond on the screen in accordance with the movements you make with the touch pad or external mouse.

## **Subtests**

There are no subtests for the Mouse test.

# Diskette Drives Test Group

The subtests in the Diskette Drives test group allow you to test diskette drives of all capacities.

## Why Run a Diskette Drives Test?

Very often, a diskette drive problem may first appear to be a diskette problem. A box of defective diskettes might produce faulty-drive error messages. The test results can be confusing, so you should run the subtests in the Diskette Drives test group more than once using diskettes from different sources.

Another possible cause of diskette drive problems is human error—for example, typing a command in an incorrect form (usually called a *syntax* error). Be sure you have entered the command properly.

When the diskette and command syntax are eliminated as causes, the following symptoms usually suggest a drive problem and warrant running a subtest in the Diskette Drives test group:

- An error message appears on the screen stating that the computer cannot *read* from or *write* to a diskette.
- A diskette cannot be properly formatted, or format error messages appear on the screen.
- Data on diskettes is corrupted or lost; these problems may be intermittent.

## Subtests

The four diskette drive subtests available in the Diskette Drives test group confirm the following drive functions:

- Change Line Test  
Checks for bent pins on the diskette drive controller and for defective lines on the diskette cable.
- Seek Test  
Checks the drive's ability to search for a specified track on the diskette and to position the read/write heads of the drive to all tracks.
- Read Test  
Positions the read/write heads at each cylinder of the diskette and verifies that all tracks on the diskette can be read correctly.
- Write Test  
Positions the read/write heads at each cylinder of the diskette and verifies that all tracks on the diskette can be written to correctly.

# IDE (ATA/ATAPI) Devices Test Group

The IDE (ATA/ATAPI) Devices test group checks the functionality of up to four devices (two on each channel) of any capacity as well as the hard-disk drive controller.

## Why Run an IDE Devices Test?

If you check your hard-disk drive to determine the amount of available space, your operating system will probably report problem areas. Problem areas on hard-disk drives are common, because most hard-disk drives have a small amount of space that is not usable. The hard-disk drive keeps a record of this space so that the computer will not attempt to use it. Identification of unusable disk space, unless it is an unusually large amount (over five percent of the possible total), should not be regarded as a cause for testing the hard-disk drive.

If you encounter a problem while using an application on CD or DVD, the problem could result from the disk or from the drive. When you encounter problems, first try using a different CD or DVD. If the problem recurs, run the IDE (ATA/ATAPI) Devices test group.

These are the most common symptoms that might prompt you to test the IDE devices:

- The hard-disk drive fails during the boot routine.
- Seek errors are reported by the operating system or application programs.
- An error message appears on the screen stating that the computer cannot *read* from or *write* to the hard-disk drive.
- Data on the hard-disk drive is corrupted or lost; these problems may be intermittent. Once saved by a program, files cannot be properly recalled.



*NOTES: Before conducting these tests on CD-ROM or DVD-ROM drives, insert a disk with audio and data tracks (such as a multimedia CD) into the drive. All of the subtests except for the Audio Test require a CD or DVD with data tracks. The Audio Test requires a CD or DVD with audio tracks.*

*If the drive is empty, or if it contains a disk that does not have the required data or audio tracks (depending on the test that you are running), the tests will fail.*

## Subtests

The four subtests in the IDE (ATA/ATAPI) Devices test group confirm the following drive functions:

- Display Information  
Test displays information about the drives connected to your system.
- Self Diagnostics Test  
Uses the drive's internal test facility to determine that is functioning correctly.

- **Seek Test**  
Checks the drive's ability to search for a specified track on the drive and to position the read/write heads of the drive to all tracks.
- **Read Test**  
Positions the read/write heads at each cylinder of the drive and verifies that all tracks on the drive can be read correctly.
- **Verify Test**  
Similar to the Read Test, expect that no data is written to the disk. Use this test to quickly scan the disk.
- **Write Test**  
Positions the read/write heads at each cylinder of the drive and verifies that all tracks on the drive can be written to correctly.
- **Media Eject Test**  
Checks the CD-ROM or DVD-ROM drive's ability to eject the tray.
- **Audio Test**  
Causes the CD-ROM or DVD-ROM drive to begin playing the first audio track on an audio CD. (To determine if the test passed, listen to the audio output of the drive.)



*NOTE: The Audio Test does not run automatically as part of the IDE (ATA/ATAPI) Devices test group; you must select the subtest individually.*

## **Serial/Infrared Ports Test Group**

The subtests in the Serial/Infrared Ports test group check the computer's interface with external devices (such as a serial mouse or a printer). The subtests in this test group are not intended as a diagnostic test for the external device itself.

### **Why Run a Serial/Infrared Ports Test?**

It may not be immediately evident whether the port or the external device is faulty. In both cases, the external device (such as a serial mouse or a printer) might behave erratically or not operate at all. Eliminate incorrect system configuration information settings, peripheral malfunctions, and software errors as potential causes of infrared (IR) port problems, before you run the subtests in the Serial/Infrared Port test group to check your hardware.

If the diagnostics do not recognize the computer's serial or infrared port, check the **Serial Port** or **Infrared Port** option in the **System Devices** menu of the Setup program to see if the port has been disabled. (See Chapter 2, "Software Features," for information on using the Setup program.) The subtests in the Serial/Infrared Ports test group cannot test a port unless it is enabled.



Another possible cause for errors is a problem with the external device itself. Use the documentation that came with the peripheral to troubleshoot it and confirm that it is working properly.

If the external device is not properly installed through software, the device also may not function properly. Try operating the device from different programs or through the operating system. If it still does not work, you can eliminate the software configuration as the cause of the problem.

Although the following symptoms can be caused by faulty peripherals or software errors, these symptoms might also suggest a port problem:

- If a peripheral works intermittently, or produces intermittent errors, the port may be faulty.
- If the computer displays an error message that is related to the external device connected to a port, but corrections to the device do not resolve the error, run the appropriate subtest in the Serial/Infrared Ports test group.

## **Subtests**

The four subtests in the Serial/Infrared Ports test group confirm the following port functions:

- **Serial/Infrared Baud Rate Test**  
Checks the baud rate generator in each serial communications chip against the computer's clock.
- **Serial/Infrared Interrupt Test**  
Checks the serial port's ability to send IRQs to the microprocessor.
- **Serial/Infrared Internal Transmission Test**  
Checks several internal functions of the serial port using the internal loopback mode of the serial communications chip.

## **Parallel Ports Test Group**

The subtests in the Parallel Ports test group check the computer's interface with external devices, such as a printer, that are connected to the computer through the parallel port. The subtests in this test group are not intended as a diagnostic test for the actual peripheral attached to each port.

### **Why Run a Parallel Ports Test?**

If the diagnostics does not recognize the computer's parallel port, check the **Parallel Port** option in the **System Devices** menu of the Setup program to see if the port has been disabled. (See Chapter 2, "Customizing System Features," for information on using the Setup program.) The subtests in the Parallel Ports test group cannot test a port unless it is enabled.

When a port is faulty, it may not be immediately evident that the port, and not the device connected to the port, is faulty. Instead, the peripheral (such as a printer) might behave erratically or not operate at all. If the external device is not properly installed through software, it also may not function properly. Try operating the peripheral from different programs or through the operating system. If it still does not work, you can eliminate the software setup as the cause of the problem.

Another possible cause for errors is a problem with the external device itself. Use the documentation that came with the peripheral to troubleshoot it and confirm that it is working properly. (Most printers have a self-test.)

After you eliminate incorrect system configuration information settings, peripheral malfunctions, and software errors as potential causes of port problems, you can run the subtests in the Parallel Ports test group to check your hardware. Although the following symptoms can be caused by faulty peripherals or software errors, they might also suggest a port problem:

- If a peripheral works intermittently, or produces intermittent errors, the port may be faulty.
- If the computer displays an error message that is related to the external device connected to a port, but corrections to the device do not resolve the error, run the appropriate subtest in the Parallel Ports test group.
- If your software and the diagnostics do not recognize that you have a parallel port, you should check the **Parallel Port** option in the **System Devices** menu of the Setup program, and if necessary, run the appropriate subtest in the Parallel Ports test group.

## **Subtests**

The four subtests in the Parallel Ports test group confirm the following port functions:

- **Parallel Internal Test**  
Checks several internal functions of the parallel port.
- **Parallel External Interrupt Test**  
Tests the parallel port's ability to generate interrupts from all possible sources, if an external loopback connector is available.
- **Parallel Printer Pattern Test**  
Tests whether the port(s) can retain data, print text on a printer, and generate interrupts.

# Audio Test Group

The subtests in the Audio test group check the functions of the audio controller and the computer's recording and playback features.

## Why Run an Audio Test?

If you do not hear sounds from your built-in speakers when you expect to, it is possible that your operating system or sound application uses resource settings different than those of the audio controller in the computer. In the absence of an expected sound, first check the documentation that accompanied your operating system or sound application to see if the sound features are correctly configured to work with the computer. The default resource settings for the audio controller are:

- DMA channel: 1
- IRQ line: 5
- Port address: 220h

If necessary, change the resource settings in your operating system or sound application to match these default settings.

If you still do not hear sound when you expect to, run the Audio test group.



*NOTE: Before running the Audio test group, make sure to enable the built-in speaker(s), and make sure that the speaker volume has not been muted.*

## Subtests

The six subtests in the Audio test group confirm the following functions:

- M2 Timer Test  
Tests the timing of audio streams from the wave processor.
- M2 IRQ Channel Test  
Checks whether the audio controller is generating an interrupt on the IRQ line configured for that controller.
- M2 Sigma RAM Test  
Tests the data transfer between the wave processor and the system chip set.
- M2 Control RAM Test  
Tests individual audio channels.
- M2 WaveCache Test  
Tests the data transfer between the audio controller and cache memory.



# CHAPTER 5

## Getting Help

This chapter describes the tools Dell provides to help you when you have a problem with your computer. It also tells you when and how to call Dell for technical or customer assistance.

### **Technical Assistance**

If you need assistance with a technical problem, perform the following steps:

1. Complete the troubleshooting checks in Chapter 3, "Troubleshooting Your Computer."
2. Run the Dell Diagnostics as described in Chapter 4, "Running the Dell Diagnostics."
3. Make a copy of the Diagnostics Checklist (found later in this chapter) and fill it out.
4. Use Dell's extensive suite of online services available at Dell's World Wide Web site (<http://www.dell.com>) for help with installation and troubleshooting procedures.

For more information, refer to "World Wide Web on the Internet" found later in this chapter.

5. If the preceding steps have not resolved the problem and you need to talk to a Dell technician, you can call Dell's technical support service.

When prompted by Dell's automated telephone system, enter your Express Service Code to route the call directly to the proper support personnel. If you do not have an Express Service Code, open the **Dell Accessories** folder, double-click the **Express Service Code** icon, and follow the directions.

*NOTE: Dell's Express Service Code system may not be available in all countries.*



For instructions on using the technical support service, refer to "Technical Support Service" and "Before You Call" found later in this chapter.

## Help Tools

Dell provides a number of tools to assist you. These tools are described in the following sections.



*NOTE: Some of the following tools are not always available in all locations outside the continental U.S. Please call your local Dell representative for information on availability.*

### System User's Guide

The *System User's Guide* includes information about traveling with your portable computer, installing and using batteries, conserving battery power, and attaching external devices to the computer. This document is installed on your hard-disk drive for easy reference wherever you take the computer.

### World Wide Web on the Internet

The Internet is your most powerful tool for obtaining information about your computer and other Dell products. Through the Internet, you can access most of the services described in this chapter, including AutoTech, TechFax, order status, technical support, and product information.



From Dell's World Wide Web home page ([www.dell.com](http://www.dell.com)), click the **Support** icon. On the Service and Support page, enter your service tag (or, if you have one, your Express Service Code) and click **Submit**. If you don't have your service tag or Express Service Code available, you can also select support information by system.

Everything you need to know about your system is presented on the system support page, including the following tools and information:

- Technical information — Details on every aspect of your system, including hardware specifications.
- Self-diagnostic tools — A system-specific troubleshooting application for resolving many computer-related issues by following interactive flowcharts.
- Drivers, files, and utilities — The latest drivers and BIOS updates to keep your system functioning at its best.
- Component support — Technical information, documentation, and troubleshooting tips for different system components.
- Online Communications Center — Tool for submitting requests for both technical and non-technical information on Dell products. Avoid telephone delays by receiving an e-mail response to your request for information if your computer is not functioning properly or if you have questions regarding your computer's hardware or operation.

Dell can be accessed electronically using the following addresses:

- World Wide Web  
**www.dell.com/**  
**www.dell.com/intl/apcc/** (for Asian/Pacific countries only)  
**www.dell.com/euro/** (for Europe only)

- Anonymous file transfer protocol (FTP)  
**ftp.dell.com/**

Log in as user : `anonymous`, and use your e-mail address as your password.

- Electronic Support Service  
**support@us.dell.com**  
**apsupport@dell.com** (for Asian/Pacific countries only)
- Electronic Quote Service  
**sales@dell.com**  
**apmarketing@dell.com** (for Asian/Pacific countries only)
- Electronic Information Service  
**info@dell.com**

## **AutoTech Service**

Dell's automated technical support service—AutoTech—provides recorded answers to the questions most frequently asked by Dell customers.

When you call AutoTech, you use your touch-tone telephone to select the subjects that correspond to your questions. You can even interrupt an AutoTech session and continue the session later. The code number that the AutoTech service gives you allows you to continue your session where you ended it.

The AutoTech service is available 24 hours a day, seven days a week. You can also access this service through the technical support service. For the telephone number to call, refer to "Dell Contact Numbers" found later in this chapter.

## **TechFax Service**

Dell takes full advantage of fax technology to serve you better. Twenty-four hours a day, seven days a week, you can call the Dell TechFax line toll-free for all kinds of technical information.

Using a touch-tone phone, you can select from a full directory of topics. The technical information you request is sent within minutes to the fax number you designate. For the TechFax telephone number to call, refer to "Dell Contact Numbers" found later in this chapter.

## **TechConnect BBS**

Use your modem to access Dell's TechConnect bulletin board service (BBS) 24 hours a day, seven days a week. The service is menu-driven and fully interactive. The protocol parameters for the BBS are 1200 to 19.2K baud, 8 data bits, no parity, 1 stop bit.

## **Automated Order-Status System**

You can call this automated service to check on the status of any Dell products that you have ordered. A recording prompts you for the information needed to locate and report on your order. For the telephone number to call, refer to "Dell Contact Numbers" found later in this chapter.

## **Technical Support Service**

Dell's industry-leading hardware technical-support service is available 24 hours a day, seven days a week, to answer your questions about Dell hardware.

Our technical support staff pride themselves on their track record: more than 90 percent of all problems and questions are taken care of in just one toll-free call, usually in less than 10 minutes. When you call, our experts can refer to records kept on your Dell system to better understand your particular question. Our technical support staff use computer-based diagnostics to provide fast, accurate answers to questions.

To contact Dell's technical support service, first refer to the section titled "Before You Call" and then call the number for your country as listed in "Dell Contact Numbers" found later in this chapter. (For information about receiving technical assistance in the U.K., refer to the *Placing a Service Call* card that came with your computer.)

## **Problems With Your Order**

If you have a problem with your order, such as missing parts, wrong parts, or incorrect billing, contact Dell Computer Corporation for customer assistance. Have your invoice or packing slip handy when you call. For the telephone number to call, refer to "Dell Contact Numbers" found later in this chapter.

## **Product Information**

If you need information about additional products available from Dell Computer Corporation, or if you would like to place an order, visit Dell's World Wide Web site at [www.dell.com/](http://www.dell.com/). For the telephone number to call to speak to a sales specialist, refer to "Dell Contact Numbers" found later in this chapter.

# Returning Items for Warranty Repair or Credit

Prepare all items being returned, whether for repair or credit, as follows:

1. Call Dell to obtain an authorization number, and write it clearly and prominently on the outside of the box.  
  
For the telephone number to call, refer to "Dell Contact Numbers" found later in this chapter.
2. Include a copy of the invoice and a letter describing the reason for the return.
3. Include a copy of the Diagnostics Checklist indicating the tests you have run and any error messages reported by the Dell Diagnostics.
4. Include any accessories that belong with the item(s) being returned (power cables, software diskettes, guides, and so on) if the return is for credit.
5. Pack the equipment to be returned in the original (or equivalent) packing materials.

You are responsible for paying shipping expenses. You are also responsible for insuring any product returned, and you assume the risk of loss during shipment to Dell Computer Corporation. Collect-on-delivery (C.O.D.) packages are not accepted.

Returns that are missing any of the preceding requirements will be refused at our receiving dock and returned to you.

## Before You Call



*NOTE: Have your Express Service Code ready when you call. The code helps Dell's automated-support telephone system direct your call more efficiently.*

Remember to fill out the Diagnostics Checklist (Figure 5-1). If possible, turn on your system before you call Dell for technical assistance and call from a telephone at or near the computer. You may be asked to type some commands at the keyboard, relay detailed information during operations, or try other troubleshooting steps possible only at the computer system itself. Make sure the system documentation is available.



**WARNING: If you need to remove the computer covers, be sure to first disconnect the computer system's power and modem cables from all electrical outlets.**



## Diagnostics Checklist

Name: \_\_\_\_\_ Date: \_\_\_\_\_

Address: \_\_\_\_\_ Phone number: \_\_\_\_\_

Service tag (bar code on the back of the computer): \_\_\_\_\_

Express Service Code: \_\_\_\_\_

Return Material Authorization Number (if provided by Dell support technician): \_\_\_\_\_

Operating system and version: \_\_\_\_\_

Peripherals: \_\_\_\_\_

\_\_\_\_\_

\_\_\_\_\_

Expansion cards: \_\_\_\_\_

\_\_\_\_\_

\_\_\_\_\_

Are you connected to a network?  yes  no

Network, version, and network card: \_\_\_\_\_

Programs and versions: \_\_\_\_\_

\_\_\_\_\_

\_\_\_\_\_

\_\_\_\_\_

Refer to your operating system documentation to determine the contents of the system's start-up files. If the computer is connected to a printer, print each file. Otherwise, record the contents of each file before calling Dell.

Error message, beep code, or diagnostic code: \_\_\_\_\_

Description of problem and troubleshooting procedures you performed: \_\_\_\_\_

\_\_\_\_\_

\_\_\_\_\_

**Figure 5-1. Diagnostics Checklist**

## Dell Contact Numbers

When you need to contact Dell, use the telephone numbers and codes provided in Tables 5-2 and 5-3. Table 5-2 provides the various codes required to make long-distance and international calls. Table 5-3 provides local telephone numbers, area codes, and toll-free numbers, if applicable, for each department or service available in various countries around the world. If you are making a direct-dialed call to a location outside of your local telephone service area, determine which codes to use (if any) in Table 5-2 in addition to the local numbers provided in Table 5-3. For example, to place an international call from Paris, France to Bracknell, England, dial the international access code for France followed by the country code for the U.K., the city code for Bracknell, and then the local number as shown in the following illustration.

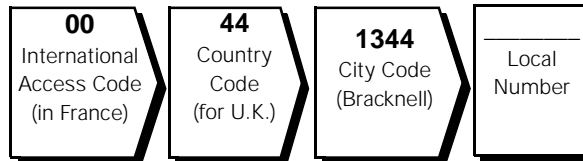

To place a long-distance call within your own country, use area codes instead of international access codes, country codes, and city codes. For example, to call Paris, France from Montpellier, France, dial the area code plus the local number as shown in the following illustration.

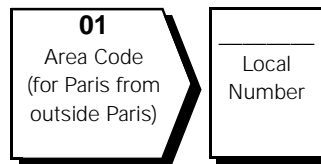

The codes required depend on where you are calling from as well as the destination of your call; in addition, each country has a different dialing protocol. If you need assistance in determining which codes to use, contact a local or an international operator.



*NOTE: Toll-free numbers are for use only within the country for which they are listed. Area codes are most often used to call long distance within your own country (not internationally)—in other words, when your call originates in the same country you are calling.*

**Table 5-1. International Dialing Codes**

<b>Country (City)</b>	<b>International Access Code</b>	<b>Country Code</b>	<b>City Code</b>
Australia (Sydney)	0011	61	2
Austria (Vienna)	900	43	1
Belgium (Brussels)	00	32	2
Brunei	—	673	—
Canada (North York, Ontario)	011	—	Not required
Chile (Santiago)	—	56	2
China (Xiamen)	—	86	592
Czech Republic (Prague)	00	420	2
Denmark (Horsholm)	009	45	Not required
Finland (Helsinki)	990	358	9
France (Paris) (Montpellier)	00	33	(1) (4)
Germany (Langen)	00	49	6103
Hong Kong	001	852	Not required
Ireland (Bray)	16	353	1
Italy (Milan)	00	39	2
Japan (Kawasaki)	001	81	44
Korea (Seoul)	001	82	2
Luxembourg	00	352	—
Macau	—	853	Not required
Malaysia (Penang)	00	60	4
Mexico (Colonia Granada)	95	52	5
Netherlands (Amsterdam)	00	31	20
New Zealand	00	64	—
Norway (Lysaker)	095	47	Not required
Poland (Warsaw)	011	48	22
Singapore (Singapore)	005	65	Not required
South Africa (Johannesburg)	09/091	27	11
Spain (Madrid)	07	34	1

**Table 5-1. International Dialing Codes** (continued)

Country (City)	International Access Code	Country Code	City Code
Sweden (Upplands Vasby)	009	46	8
Switzerland (Geneva)	00	41	22
Taiwan	002	886	—
Thailand	001	66	—
U.K. (Bracknell)	010	44	1344
U.S.A. (Austin, Texas)	011	1	Not required

**Table 5-2. Dell Contact Numbers**

Country (City)	Department Name or Service	Area Code	Local Number or Toll-Free Number
<b>Australia</b> (Sydney)	Customer Technical Support (Dell Dimension® systems only) . . . . .		1-300-65-55-33
	Customer Technical Support (Other systems) . . . . .		toll free: 1-800-633-559
	Customer Care . . . . .		toll free: 1-800-819-339
	Corporate Sales . . . . .		toll free: 1-800-808-385
	Transaction Sales . . . . .		toll free: 1-800-808-312
	Fax . . . . .		toll free: 1-800-818-341
<b>Austria*</b> (Vienna)	Switchboard . . . . .		491 04 0
	Technical Support . . . . .		0660-8779
<b>Belgium*</b> (Brussels)	Customer Technical Support . . . . .	02	4819288
	Sales . . . . .		toll free: 0800 16884
	SalesFax . . . . .	02	4819299
	Switchboard . . . . .	02	4819100
	Fax . . . . .	02	4819299
<b>Brunei</b>	Customer Technical Support (Penang, Malaysia) . . . . .		.810 4966
	Customer Service (Penang, Malaysia) . . . . .		.810 4949
	Transaction Sales (Penang, Malaysia) . . . . .		.810 4955

\* For technical assistance in this country after normal working hours, use one of the following numbers:  
(353-1) 204 4008 or (353-1) 286 5908 (English only—the call is rerouted to the U.S.A.).

**Table 5-2. Dell Contact Numbers** (continued)

Country (City)	Department Name or Service	Area Code	Local Number or Toll-Free Number
<b>Canada</b> (North York, Ontario)  <i>NOTE: Customers in Canada call the U.S.A. for access to TechConnect BBS.</i>	Automated Order-Status System . . . . .		toll free: 1-800-433-9014
	AutoTech (Automated technical support) . . . . .		toll free: 1-800-247-9362
	Customer Care (From outside Toronto) . . . . .		toll free: 1-800-387-5759
	Customer Care (From within Toronto) . . . . .	416	. . . . . 758-2400
	Customer Technical Support . . . . .		toll free: 1-800-847-4096
	Sales (Direct Sales—from outside Toronto) . . . . .		toll free: 1-800-387-5752
	Sales (Direct Sales—from within Toronto) . . . . .	416	. . . . . 758-2200
	Sales (Federal government, education, and medical) . . . . .		toll free: 1-800-567-7542
	Sales (Major Accounts) . . . . .		toll free: 1-800-387-5755
	TechConnect BBS (Austin, Texas, U.S.A.) . . . . .	512	. . . . . 728-8528
TechFax . . . . .		toll free: 1-800-950-1329	
<b>Chile</b> (Santiago)  <i>NOTE: Customers in Chile call the U.S.A for sales, customer, and technical assistance.</i>	Sales, Customer Support, and Technical Support . . . . . toll free: 1230-020-4823		
<b>China</b> (Xiamen)	Customer Service . . . . . toll free: 800 858 2437		
	Sales . . . . . toll free: 800 858 2222		
<b>Czech Republic*</b> (Prague)	Technical Support . . . . . 02 . . . . . 22 83 27 27		
	Fax . . . . . 02 . . . . . 22 83 27 14		
	TechFax . . . . . 02 . . . . . 22 83 27 28		
	Switchboard . . . . . 02 . . . . . 22 83 27 11		
<b>Denmark*</b> (Horsholm)	Customer Care, Technical Support, and Sales . . . . . toll free: 800 171 62		
<b>Finland*</b> (Helsinki)	Technical Support . . . . . 09 . . . . . 253 313 60		
	Customer Service . . . . . 09 . . . . . 253 313 61		
	Fax . . . . . 09 . . . . . 253 313 99		
	Switchboard . . . . . 09 . . . . . 253 313 00		

\* For technical assistance in this country after normal working hours, use one of the following numbers: (353-1) 204 4008 or (353-1) 286 5908 (English only—the call is rerouted to the U.S.A.).

**Table 5-2. Dell Contact Numbers** (continued)

<b>Country (City)</b>	<b>Department Name or Service</b>	<b>Area Code</b>	<b>Local Number or Toll-Free Number</b>
<b>France*</b> (Paris/Montpellier)	Technical Support (Paris) . . . . .	01 . . . . .	47 62 68 90
	Technical Support (Montpellier) . . . . .	04 . . . . .	67 06 62 86
	Customer Care (Major Accounts) (Paris) . . . . .	01 . . . . .	47 62 69 39
	Customer Care (VAR Accounts) (Paris) . . . . .	01 . . . . .	47 62 69 26
	Customer Care (Direct Sales) (Paris) . . . . .	01 . . . . .	47 62 69 76
	TechFax (Montpellier) . . . . .	04 . . . . .	67 22 53 11
	TechConnect BBS (Montpellier) . . . . .	04 . . . . .	67 22 53 04
	Switchboard (Paris) . . . . .	01 . . . . .	47 62 68 50
	Switchboard (Montpellier) . . . . .	04 . . . . .	67 06 65 51
<b>Germany*</b> (Langen)	Customer Technical Support . . . . .	06103 . . . . .	.971-200
	Customer Care . . . . .	06103 . . . . .	.971-500
	TechConnect BBS . . . . .	06103 . . . . .	.971-666
	Sales . . . . .	06103 . . . . .	.971-460
<b>Hong Kong</b>  <i>NOTE: Customers in Hong Kong call Malaysia for customer assistance.</i>	Technical Support . . . . .		toll free: 800 96 4107
	Customer Service (Penang, Malaysia) . . . . .		.810 4949
	Transaction Sales . . . . .		toll free: 800 96 4109
	Corporate Sales . . . . .		toll free: 800 96 4108
<b>Ireland*</b> (Bray)	Customer Technical Support . . . . .		1-850-543-543
	Sales . . . . .		1-850-235-235
	SalesFax . . . . .	01 . . . . .	286 2020
	Fax . . . . .	01 . . . . .	286 6848
	TechConnect BBS . . . . .	01 . . . . .	.204 4711
	TechFax . . . . .	01 . . . . .	204 4708
	Switchboard . . . . .	01 . . . . .	286 0500
<b>Italy*</b> (Milan)	Switchboard . . . . .		.577821
	Fax . . . . .		57503530

\* For technical assistance in this country after normal working hours, use one of the following numbers: (353-1) 204 4008 or (353-1) 286 5908 (English only—the call is rerouted to the U.S.A.).

**Table 5-2. Dell Contact Numbers** (continued)

Country (City)	Department Name or Service	Area Code	Local Number or Toll-Free Number
<b>Japan</b> (Kawasaki)	Technical Support . . . . .		toll free: 0088-22-7890
	Customer Care . . . . .	044 . . . . .	556-4240
	Direct Sales . . . . .	044 . . . . .	556-3344
	Commercial Sales . . . . .	044 . . . . .	556-3430
			556-3440
Switchboard . . . . .	044 . . . . .	556-4300	
<b>Korea</b> (Seoul)  <i>NOTE: Customers in Korea call Malaysia for customer assistance.</i>	Technical Support . . . . .		toll free: 080-200-3800
	Transaction Sales . . . . .		toll free: 080-200-3600
	Corporate Sales . . . . .		toll free: 080-200-3900
	Customer Service (Penang, Malaysia) . . . . .		810 4949
	Fax . . . . .		394 3122
	Switchboard . . . . .		287 5600
<b>Latin America</b>  <i>NOTE: Customers in Latin America call the U.S.A. for sales, customer, and technical assistance.</i>	Customer Technical Support (Austin, Texas, U.S.A.) . . . . .	512 . . . . .	728-4093
			728-3619
	Customer Service (Austin, Texas, U.S.A.) . . . . .	512 . . . . .	728-3883
	Fax (Technical Support and Customer Service) (Austin, Texas, U.S.A.) . . . . .	512 . . . . .	728-4397
			728-4600
	Sales (Austin, Texas, U.S.A.) . . . . .	512 . . . . .	728-3772
SalesFax (Austin, Texas, U.S.A.) . . . . .	512 . . . . .	728-3772	
<b>Luxembourg*</b>  <i>NOTE: Customers in Luxembourg may call Belgium for sales, customer, and technical assistance as well as the SalesFax service, and they call the Netherlands for the TechFax and TechConnect BBS services.</i>	Customer Technical Support (Brussels, Belgium) . . . . .		toll free: 0800 2109
	Customer Service (Luxembourg) . . . . .		295151
	Customer Service (Brussels, Belgium) . . . . .	02 . . . . .	481 92 99
	SalesFax (Brussels, Belgium) . . . . .	02 . . . . .	481 92 44
	TechFax (Amsterdam, Netherlands) . . . . .		682 91 06
	TechConnect BBS (Amsterdam, Netherlands) . . . . .		686 65 04

\* For technical assistance in this country after normal working hours, use one of the following numbers: (353-1) 204 4008 or (353-1) 286 5908 (English only—the call is rerouted to the U.S.A.).

**Table 5-2. Dell Contact Numbers (continued)**

Country (City)	Department Name or Service	Area Code	Local Number or Toll-Free Number
<b>Macau</b>  <i>NOTE: Customers in Macau call Malaysia for customer assistance.</i>	Technical Support . . . . .		toll free: 0800 582
	Customer Service (Penang, Malaysia) . . . . .		.810 4949
	Transaction Sales . . . . .		toll free: 0800 581
<b>Malaysia</b> (Penang)	Technical Support . . . . .		toll free: 1 800 888 298
	Customer Service . . . . .	04	.810 4949
	Transaction Sales . . . . .		toll free: 1 800 888 202
	Corporate Sales . . . . .		toll free: 1 800 888 213
<b>Mexico</b> (Colonia Granada)  <i>NOTE: Customers in Mexico call the U.S.A. for access to the Automated Order-Status System and AutoTech.</i>	Automated Order-Status System (Austin, Texas, U.S.A.) . . . . .	512	728-0685
	AutoTech (Automated technical support) (Austin, Texas, U.S.A.) . . . . .	512	728-0686
	Customer Technical Support . . . . .	525	228-7870
	Sales . . . . .	525	228-7811
			toll free: 91-800-900-37
			toll free: 91-800-904-49
<b>Netherlands*</b> (Amsterdam)	Customer Technical Support . . . . .	020	5818838
	Direct Sales . . . . .		toll free: 0800-0663
	Direct SalesFax . . . . .	020	682 7171
	Corporate Sales . . . . .	020	581 8818
	Corporate SalesFax . . . . .	020	686 8003
	TechConnect BBS . . . . .	020	686 6504
<b>New Zealand</b>	Technical Support (Dell Dimension systems only) (\$2.50 + GST per call) . . . . .		0900 51010
	Technical Support (Other systems) . . . . .		0800 446 255
	Customer Service . . . . .		0800 444 617
	Sales . . . . .		0800 441 567
	Fax . . . . .		0800 441 566

\* For technical assistance in this country after normal working hours, use one of the following numbers: (353-1) 204 4008 or (353-1) 286 5908 (English only—the call is rerouted to the U.S.A.).



**Table 5-2. Dell Contact Numbers** (continued)

<b>Country (City)</b>	<b>Department Name or Service</b>	<b>Area Code</b>	<b>Local Number or Toll-Free Number</b>
<b>Norway*</b> (Lysaker)	Customer Technical Support and Customer Service . . . . .		22-67 50 00
	Sales . . . . .		67-125 711
<b>Poland*</b> (Warsaw)	Switchboard . . . . .		60 61 999
	Fax . . . . .		60 61 998
<b>Singapore</b> (Singapore)  <i>NOTE: Customers in Singapore call Malaysia for customer assistance.</i>	Technical Support . . . . .		toll free: 800 6011 051
	Customer Service (Penang, Malaysia) . . . . .	04	810 4949
	Transaction Sales . . . . .		toll free: 800 6011 054
	Corporate Sales . . . . .		toll free: 800 6011 053
<b>South Africa</b> (Johannesburg)	Switchboard . . . . .	011	709 7700
	Technical Support . . . . .	011	709 7710
	Fax . . . . .	011	706 0495
<b>Southeast Asian/Pacific Countries</b> (excluding Australia, Brunei, China, Hong Kong, Japan, Korea, Macau, Malaysia, New Zealand, Singapore, Taiwan, and Thailand—refer to individual listings for these countries)	Customer Technical Support, Customer Service, and Sales (Penang, Malaysia) . . . . .		60 4 810-4810
<b>Spain*</b> (Madrid)	Technical Support . . . . .	91	902 100 130
	Customer Service . . . . .	91	329 10 80
	TechConnect BBS . . . . .	91	329 33 53
	Sales . . . . .	91	902 100 185
	Switchboard . . . . .	91	722 92 00
<b>Sweden*</b> (Upplands Vasby)	Technical Support . . . . .	08	590 05 199
	Customer Care . . . . .	08	590 05 169
	TechConnect BBS . . . . .	08	590 05 591
	Sales . . . . .	08	590 05 185

\* For technical assistance in this country after normal working hours, use one of the following numbers: (353-1) 204 4008 or (353-1) 286 5908 (English only—the call is rerouted to the U.S.A.).

**Table 5-2. Dell Contact Numbers** (continued)

<b>Country (City)</b>	<b>Department Name or Service</b>	<b>Area Code</b>	<b>Local Number or Toll-Free Number</b>
<b>Switzerland*</b> (Geneva)	Technical Support . . . . .		0844 811 411
	Commercial Services . . . . .	022	799 01 01
	Customer Service . . . . .	022	799 01 50
	Fax . . . . .	022	799 01 90
<b>Taiwan</b>  <i>NOTE: Customers in Taiwan call Malaysia for customer assistance.</i>	Technical Support . . . . .	toll free:	0080 651 226/0800 33 557
	Customer Service (Penang, Malaysia) . . . . .		810 4949
	Transaction Sales . . . . .	toll free:	0080 651 228/0800 33 556
	Corporate Sales . . . . .	toll free:	0080 651 227/0800 33 555
<b>Thailand</b>  <i>NOTE: Customers in Thailand call Malaysia for customer assistance.</i>	Technical Support . . . . .		toll free: 0880 060 07
	Customer Service (Penang, Malaysia) . . . . .		810 4949
	Sales. . . . .		toll free: 0880 060 06
<b>U.K.*</b> (Bracknell)	Customer Technical Support (OptiPlex® systems and portable computers) . . . . .	01344	723723
	Customer Care . . . . .	01344	720110
	TechFax . . . . .	01344	723178
	TechConnect BBS. . . . .	01344	723858
	Sales. . . . .	01344	720000

\* For technical assistance in this country after normal working hours, use one of the following numbers: (353-1) 204 4008 or (353-1) 286 5908 (English only—the call is rerouted to the U.S.A.).

**Table 5-2. Dell Contact Numbers** (continued)

Country (City)	Department Name or Service	Area Code	Local Number or Toll-Free Number	
<b>U.S.A.</b> (Austin, Texas)	Automated Order-Status System . . . . .		toll free: 1-800-433-9014	
	AutoTech (Automated technical support) . . . . .		toll free: 1-800-247-9362	
	<b>Dell Home and Small Business Group:</b>	Customer Technical Support		(Return Material Authorization Numbers) . . . . . toll free: 1-800-624-9896
	Customer Service		(Credit Return Authorization Numbers) . . . . . toll free: 1-800-624-9897	
	<b>National Accounts</b> (systems purchased by established Dell national accounts [have your account number handy], medical institutions, or value-added resellers [VARs]):	Customer Service and Technical Support		(Return Material Authorization Numbers) . . . . . toll free: 1-800-822-8965
	<b>Public Americas International</b> (systems purchased by governmental agencies [local, state, or federal] or educational institutions):	Customer Service and Technical Support		(Return Material Authorization Numbers) . . . . . toll free: 1-800-234-1490
	Dell Sales . . . . .		toll free: 1-800-247-4618	
	Spare Parts Sales . . . . .		toll free: 1-800-357-3355	
	DellWare® . . . . .		toll free: 1-800-753-7201	
	DellWare FaxBack Service . . . . .	512 . . . . .	728-1681	
	Fee-Based Technical Support . . . . .		toll free: 1-800-433-9005	
	Sales (Catalogs) . . . . .		toll free: 1-800-426-5150	
	Fax . . . . .		toll free: 1-800-727-8320	
	TechFax . . . . .		toll free: 1-800-950-1329	
	TechConnect BBS . . . . .	512 . . . . .	728-8528	
	Switchboard . . . . .	512 . . . . .	338-4400	



# APPENDIX A

## Technical Specifications

**Table A-1. Technical Specifications**

<b>Microprocessor</b>	
Microprocessor type . . . . .	Intel Mobile Module Pentium microprocessor with MMX technology
Microprocessor speed . . . . .	266 or 300 MHz
Internal cache memory . . . . .	32 KB
External cache memory . . . . .	512-KB pipelined-burst SRAM
Math coprocessor . . . . .	internal to the microprocessor
<b>Chip Set and Bus</b>	
System chip set . . . . .	Intel 440BX AGP
Host data bus width . . . . .	64 bits
DRAM bus width . . . . .	64 bits
Host address bus width . . . . .	32 bits
Flash EPROM . . . . .	4 Mb
<b>PC Card</b>	
PCI controller . . . . .	Texas Instruments PCI 1220 cardbus controller
PC Card connectors . . . . .	two (supports two type I or type II cards or one type III card)
Cards supported . . . . .	3.3 V and 5 V
PC Card connector size . . . . .	68 pins
Data width (maximum) . . . . .	32 bits

*NOTE: For the full name of an abbreviation or acronym used in this table, see the Glossary in the System User's Guide.*

**Table A-1. Technical Specifications** (continued)

<b>Memory</b>	
Architecture . . . . .	SDRAM
Memory module capacities . . . . .	32- and 64-MB SODIMM
Standard RAM . . . . .	32- or 64-MB on system board
Maximum RAM . . . . .	192 MB
Memory access time/clock frequency . . . . .	66 MHz
BIOS address . . . . .	F000:0000
<b>Connectors</b>	
Serial (DTE) . . . . .	one 9-pin connector; 16550-compatible, 16-byte buffer
Parallel . . . . .	one 25-hole connector; unidirectional, bidirectional, EPP 1.9, or ECP
Monitor . . . . .	one 15-hole connector
PS/2 keyboard/mouse . . . . .	one 6-pin mini-DIN connector
Infrared . . . . .	one IrDA 1.1 port
Expansion connector . . . . .	240 pins
Audio . . . . .	microphone, headphones/speakers, and line-in jacks
TV-out . . . . .	one 7-pin S-video type
USB . . . . .	one 4-pin connector
<b>Integrated Audio</b>	
Audio type . . . . .	Sound Blaster Pro-compatible voice and music functions
Audio controller . . . . .	ESS Technology Maestro-2
Conversion . . . . .	16-bit (stereo analog-to-digital and digital-to-analog)
FM music . . . . .	20-voice, 72-operator
Interfaces:	
Internal . . . . .	PCI bus, microphone, dual stereo speakers
External . . . . .	microphone (minijack); headphone; line-in
<i>NOTE: For the full name of an abbreviation or acronym used in this table, see the Glossary in the System User's Guide.</i>	

**Table A-1. Technical Specifications** (continued)

<b>Integrated Audio</b> (continued)	
Internal speaker amplifier . . . . .	1.0 W stereo (0.5 W per speaker)
External microphone input voltage range . . . . .	280 mV peak to peak
Line/audio input voltage range. . . . .	2.8 V peak to peak
Controls . . . . .	volume can be controlled through thumb wheel and software application menus
<b>Video</b>	
Video type . . . . .	64-bit (128-bit hardware-accelerated) AGP
Video controller . . . . .	4- or 8-MB ATI Rage Pro LT
Video memory . . . . .	2 MB, 100 MHz
<b>Display (14.1-inch)</b>	
Type . . . . .	TFT XGA
Dimensions:	
Height . . . . .	228 mm (8.9 inches)
Width . . . . .	299.5 mm (11.8 inches)
Diagonal . . . . .	358.1 mm (14.1 inches)
Maximum resolution . . . . .	1024 x 768 pixels; 64,000 colors
Response time (typical) . . . . .	80 ms
Operating angle . . . . .	0° (closed) to 170°
Dot pitch . . . . .	0.264 mm
Power consumption. . . . .	3.9 W
Controls . . . . .	brightness can be controlled through key combinations
<b>Display (13.3-inch)</b>	
Type . . . . .	TFT XGA
Dimensions:	
Height . . . . .	214 mm (8.4 inches)
Width . . . . .	296.5 mm (11.7 inches)
Diagonal . . . . .	337.8 mm (13.3 inches)

*NOTE: For the full name of an abbreviation or acronym used in this table, see the Glossary in the System User's Guide.*

**Table A-1. Technical Specifications** (continued)

---

<b>Display (13.3-inch)</b> (continued)	
Maximum resolution . . . . .	1024 x 768 pixels; 64,000 colors
Response time (typical). . . . .	80 ms
Operating angle. . . . .	0° (closed) to 170°
Dot pitch . . . . .	0.264 mm
Power consumption . . . . .	3.9 W
Controls. . . . .	brightness can be controlled through key combinations

---

<b>Keyboard</b>	
Number of keys. . . . .	87 (U.S. and Canada); 88 (Europe); 88 (Japan)
Key travel. . . . .	3.0 ± 0.5 mm (0.12 ± 0.02 inch)
Key spacing . . . . .	19.1 mm (0.75 inch)
Layout . . . . .	QWERTY/AZERTY/Kanji

---

<b>Touch Pad</b>	
Interface . . . . .	PS/2-compatible
X/Y position resolution (graphics table mode) . . . . .	20 points/mm (500 points/inch)
Size:	
Thickness. . . . .	4.65 mm (0.18 inch) at highest component
Width . . . . .	64-mm (2.52-inch) sensor-active area
Height . . . . .	47.0-mm (1.85-inch) rectangle with 0.5-mm (0.02-inch) tabs
Weight . . . . .	15 g (0.52 ounce) ± 0.5 g (0.001 ounce)
Power:	
Supply voltage . . . . .	5 V ± 10%
Supply current . . . . .	4 mA (maximum operating current)

---

*NOTE: For the full name of an abbreviation or acronym used in this table, see the Glossary in the System User's Guide.*

**Table A-1. Technical Specifications** (continued)

<b>Main Battery</b>	
Type . . . . .	lithium ion
Dimensions:	
Height . . . . .	23.8 mm (0.94 inch)
Depth . . . . .	148.2 mm (5.83 inches)
Width . . . . .	116.2 mm (4.58 inches)
Weight . . . . .	0.60 kg (1.32 lb)
Voltage . . . . .	14.4 VDC
Capacity . . . . .	60 WH
Charge time (approximate): <sup>1</sup>	
Computer on . . . . .	2.5 hour
Computer off . . . . .	2 hour
Life span (approximate) <sup>1</sup> . . . . .	400 discharge/charge cycles
Temperature range:	
Charge . . . . .	5°C to 35°C (41°F to 95°F)
Discharge . . . . .	5°C to 35°C (41°F to 95°F)
Storage . . . . .	-20°C to 50°C (-4°F to 122°F)
<b>AC Adapter</b>	
Input voltage . . . . .	90 VAC to 264 VAC
Input current (maximum) . . . . .	1.5 A at 90 VAC, full load
Input frequency . . . . .	47 Hz to 63 Hz
Output current . . . . .	2.4 A (continuous)
Output power . . . . .	70 W
Rated output voltage . . . . .	20 VDC
Height . . . . .	29.6 mm (1.17 inches)
Width . . . . .	60.0 mm (2.36 inches)
Depth . . . . .	105 mm (4.13 inches)

<sup>1</sup> Battery performance features such as charge time, operating time, and life span can vary according to the conditions under which the computer and battery are used.

NOTE: For the full name of an abbreviation or acronym used in this table, see the Glossary in the System User's Guide.



**Table A-1. Technical Specifications** (continued)

<b>AC Adapter</b> (continued)	
Weight (with cables) . . . . .	0.3 kg (0.71 lb)
Temperature range:	
Operating . . . . .	0°C to 40°C (32°F to 104°F)
Storage . . . . .	-20°C to 65°C (-4°F to 149°F)
<b>Physical</b>	
Height . . . . .	54 mm (2.1 inches)
Width . . . . .	318 mm (12.52 inches)
Depth . . . . .	254 mm (10 inches)
Weight (with hard-disk drive, diskette drive, and CD-ROM drive) . . . . .	3.74 kg (8.25 lb) with 13.3-inch display 3.8 kg (8.37 lb) with 14.1-inch display
<b>Environmental (Computer)</b>	
Temperature:	
Operating . . . . .	5°C to 35°C (41°F to 95°F)
Storage . . . . .	-20°C to 50°C (-4°F to 122°F)
Relative humidity . . . . .	10% to 90% (noncondensing)
Maximum vibration:	
Operating . . . . .	0.8 GRMS using a random-vibration spec- trum that simulates air shipment
Storage . . . . .	1.3 GRMS using a random-vibration spec- trum that simulates truck shipment
Maximum shock: <sup>2</sup>	
Operating . . . . .	1.52 m/sec (4.98 feet/sec) (less than or equal to a pulse width of 2 ms)
Storage . . . . .	2.03 m/sec (6.66 feet/sec) (less than or equal to a pulse width of 2 ms)
Altitude:	
Operating . . . . .	0 m to 3048 m (0 ft to 10,000 ft)
Storage . . . . .	0 m to 12,192 m (0 ft to 40,000 ft)

<sup>2</sup> Measured with the hard-disk drive in head-parked position.

NOTE: For the full name of an abbreviation or acronym used in this table, see the Glossary in the System User's Guide.



# **APPENDIX B**

## ***Diagnostic Video Tests***

The Video Test Group of the Dell Diagnostics consists of the following eight tests, each of which verifies a particular video function or group of functions on your display or on an external monitor:

- Video Memory Test — Checks the integrity of characters generated from data in the video memory
- Video Hardware Test — Checks the functions of the cursor register and the horizontal and vertical retrace bit registers
- Text Mode Character Test — Checks the video subsystem's ability to present text mode data
- Text Mode Color Test — Checks the video subsystem's ability to present color in text modes
- Text Mode Pages Test — Checks the video subsystem's ability to map and present all available video text pages on the display or monitor, one page at a time
- Graphics Mode Test — Checks the video subsystem's ability to present graphics mode data and colors
- Color Palettes Test — Checks the video subsystem's ability to display all available colors
- Solid Colors Test — Checks the video subsystem's ability to show screens full of solid colors and to display all pixels

All of these tests, except the Video Memory Test and the Video Hardware Test, are interactive. These interactive tests display images on the display or monitor and require you to respond with the following steps:

1. Examine a displayed image for correctness.
2. If an image is correct, type **y**.
3. If an image is incorrect, type **n**.

The following sections describe each of the tests in the Video Test Group.

## **Video Memory Test**

The Video Memory Test verifies the integrity of the video memory on the system board. When a test is complete, a message indicates whether the video memory has passed or failed the test. This test does not require any interaction on your part.

## **Video Hardware Test**

The Video Hardware Test verifies the operation of the cursor registers and the horizontal and vertical retrace bit registers. When a test is complete, a message indicates whether these registers have passed or failed the test. This test does not require any interaction on your part.

## **Text Mode Character Test**

The Text Mode Character Test consists of a group of subtests that display printable characters and character attributes. The subtests check character quality and the ability of the display or monitor to show the characters correctly. A prompt at the bottom of each screen asks you to decide whether the display is satisfactory and to respond by typing *y* or *n*.

If you respond affirmatively to each subtest, the Text Mode Character Test passes. A negative response to any subtest causes the test to fail.

The following subsections describe the subtests of the Text Mode Character Test in the order in which they appear.

### **Character Attributes Subtest (80 x 25)**

The 80-column x 25-line character attributes subtest displays four lines of text that demonstrate normal-intensity video, reverse video, intensified video, and blinking video.

### **Character Set Subtest (80 x 25)**

The 80-column x 25-line character set subtest displays all 256 characters in the American Standard Code for Information Interchange (ASCII) character set in 80-column by 25-line text mode. Figure B-1 shows part of the 80-column x 25-line character set subtest screen.

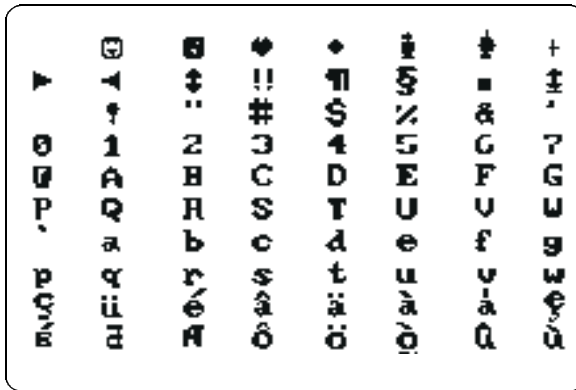

**Figure B-1. 80-Column x 25-Line Character Set Subtest Screen**

### **Character Attributes Subtest (40 x 25)**

The 40-column x 25-line character attributes subtest displays four lines of text, in 40-column by 25-line (double-wide) text mode, that demonstrate normal-intensity video, reverse video, intensified video, and blinking video.

### **Character Set Subtest (40 x 25)**

The 40-column x 25-line character set subtest displays all 256 characters in the ASCII character set in 40-column by 25-line (double-wide) text mode. Figure B-2 shows part of the 40-column x 25-line character set subtest screen.

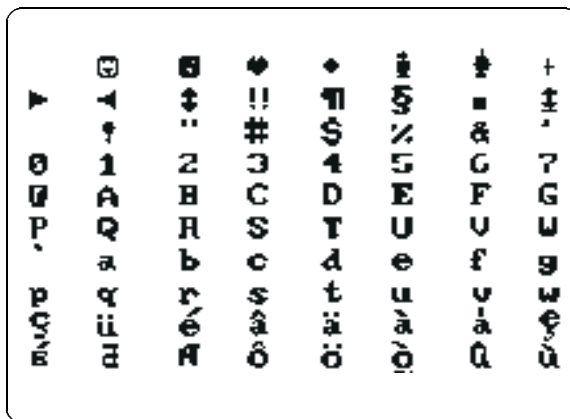

**Figure B-2. 40-Column x 25-Line Character Set Subtest Screen**

# Text Mode Color Test

The Text Mode Color Test contains three subtests that check the video subsystem's ability to present color in text modes. The following subsections describe these subtests.

## Color Attributes Subtest (80 x 25)

The 80-column x 25-line color attributes subtest displays a pattern of 16 rows and 16 columns in 80-column by 25-line text mode. Each row has a hexadecimal number in a unique foreground color and each column has a unique background color. Where the same foreground and background color intersect, the hexadecimal number is not visible. Type *y* if each character is displayed correctly; otherwise, type *n*. Table B-1 indicates the color in each of the rows and columns.

**Table B-1. Color Attributes**

Row or Column Number	Foreground Color	Background Color
0	black	black
1	blue	blue
2	green	green
3	cyan	cyan
4	red	red
5	magenta	magenta
6	brown	brown
7	white	white
8	dark gray*	black
9	light blue*	blue
A	light green*	green
B	light cyan*	cyan
C	light red*	red
D	light magenta*	magenta
E	yellow*	brown
F	intense white*	white

\* These colors blink during the test.

## **Color Attributes Subtest (40 x 25)**

The 40-column x 25-line color attributes subtest is the same as the previous subtest except that the characters are displayed in 40-column by 25-line (double-wide) text mode. Type *y* if each character is displayed correctly; otherwise, type *n*.

## **Color Bars Subtest**

The color bars subtest displays 16 bars in different colors with background intensity enabled. Under each bar is the name of the color that should be displayed. Type *y* if each color bar is displayed correctly; otherwise, type *n*.

## **Text Mode Pages Test**

The Text Mode Pages Test checks the video subsystem's ability to map and present all available video pages on the display or monitor, one page at a time. The test displays eight successive screens, the first of which contains 21 lines of 77 zeros. The remaining seven screens are identical to the first, except that each screen substitutes a different numeral (1 through 7) for the zeros.

Type *y* if all the rows of numbers on each screen are displayed correctly; otherwise, type *n*.

## **Graphics Mode Test**

The Graphics Mode Test checks the video subsystem's ability to present graphics mode data and colors. This test displays a number of different screens, each of which allows you to check some aspect of graphics mode data and colors. The following subsections describe the Graphics Mode Test screens in the order in which they appear.

### **320 x 200 Graphics Mode Screens**

The Graphics Mode Test displays two successive 320- x 200-pixel graphics mode screens. The first screen displays three pyramids in red, green, and yellow. The second screen displays three pyramids in magenta, cyan, and white. Type *y* if all the pyramids are the correct colors; otherwise, type *n*.

### **320 x 200 16-Color Graphics Mode Screen**

The 320- x 200-pixel 16-color graphics mode screen displays a series of Xs in 16 different colors with the name of the color beneath each X. Type *y* if all the Xs are the correct colors; otherwise, type *n*.

### **640 x 200 16-Color Graphics Mode Screen**

The 640- x 200-pixel 16-color graphics mode screen displays a series of hexagons in 16 different colors with the name of the color beneath each hexagon. Type *y* if all the hexagons are the correct colors; otherwise, type *n*.

### **640 x 350 16-Color Graphics Mode Screen**

The 640- x 350-pixel 16-color graphics mode screen displays a series of octagons in 16 different colors with the name of the color displayed beneath each octagon. Type *y* if all the octagons are the correct colors; otherwise, type *n*.

### **640 x 480 2-Color Graphics Mode Screen**

The 640- x 480-pixel 2-color graphics mode screen displays three chess pieces. Type *y* if all the chess pieces are identical and displayed correctly; otherwise, type *n*. Figure B-3 shows part of this screen.

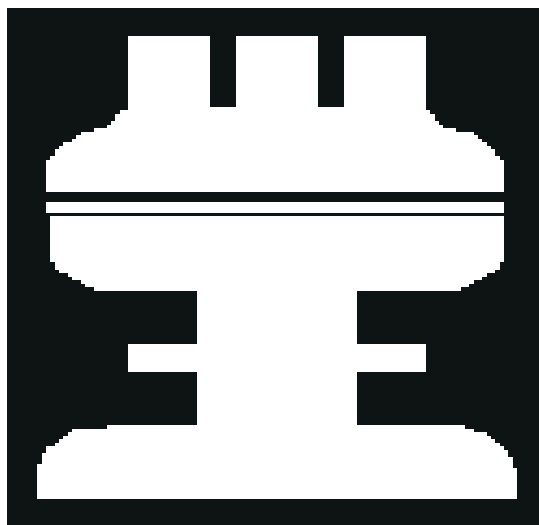

**Figure B-3. 640 x 480 2-Color Graphics Mode Screen**

### **640 x 480 16-Color Graphics Mode Screen**

The 640- x 480-pixel 16-color graphics mode screen displays a series of stars in 16 different colors with the name of the color beneath each star. Type *y* if all the stars are the correct colors; otherwise, type *n*.

### **320 x 200 256-Color Graphics Mode Screen**

The 320- x 200-pixel 256-color graphics mode screen displays a series of squares in 256 different color hues and intensities. Type *y* if all the squares are the correct colors; otherwise, type *n*.

### **640 x 480 256-Color Graphics Mode Screen**

The 640- x 480-pixel 256-color graphics mode screen displays a series of squares with two colors in each square. Type *y* if all the squares appear to be correct; otherwise, type *n*.

### **800 x 600 16-Color Graphics Mode Screen**

The 800- x 600-pixel 16-color graphics mode screen displays a series of pyramids in 16 different colors with the name of the color beneath each pyramid. Type *y* if all the pyramids appear to be correct; otherwise, type *n*.

### **800 x 600 256-Color Graphics Mode Screen**

The 800- x 600-pixel 256-color graphics mode screen displays a series of squares with four colors in each square. Type *y* if all the squares appear to be correct; otherwise, type *n*.

### **1024 x 768 16-Color Graphics Mode Screen**

The 1024- x 768-pixel 16-color graphics mode screen displays a series of hourglasses in 16 different colors with the name of the color beneath each hourglass. Type *y* if all the hourglasses appear to be correct; otherwise, type *n*.

### **1024 x 768 256-Color Graphics Mode Screen**

The 1024- x 768-pixel 256-color graphics mode screen displays a series of asterisks with four colors in each asterisk. Type *y* if all the asterisks appear to be correct; otherwise, type *n*.

## **Color Palettes Test**

The Color Palettes Test checks the video subsystem's ability to display all available colors. The test displays two screens that allow you to check the quality of different shades of the basic colors and to test the ability of the display or monitor to vary the intensity of these colors.

The first screen contains four sets of 64 squares, one for gray and one for each of the three basic colors (red, green, and blue). Each square contains a different shade of its associated color, ranging from very light to very dark. Type *y* if all the squares are the correct colors; otherwise, type *n*.



The second screen is the red/green/blue (RGB) color combination screen. This screen allows you to test the ability of the display or monitor to increase or decrease the intensity of the three basic colors.

The RGB color combination screen displays an RGB box in the top center of the screen with individual red, green, and blue boxes beneath it. Underneath the individual color boxes are three lines that show the intensity of each color. Type **r**, **g**, or **b** to adjust the intensity of the corresponding color; then press the right-arrow key to increase the color intensity, or press the left-arrow key to decrease the intensity. Type **y** if all the squares are the correct colors; otherwise, type **n**.

## ***Solid Colors Test***

The Solid Colors Test checks whether the video subsystem is displaying the correct colors. This test also lets you check for missing pixels. When this test is running, four screens appear sequentially—a red screen, a green screen, a blue screen, and a white screen. Check each screen for missing pixels, and verify that the correct color is being displayed.

When the test is complete, a message asks if you are satisfied with the quality of the colors. Type **y** if all the pixels were present and if the correct colors were displayed; otherwise, type **n**.



# APPENDIX C

## *Regulatory Notices*

Electromagnetic Interference (EMI) is any signal or emission, radiated in free space or conducted along power or signal leads, that endangers the functioning of a radio navigation or other safety service or seriously degrades, obstructs, or repeatedly interrupts a licensed radio communications service. Radio communications services include but are not limited to AM/FM commercial broadcast, television, cellular services, radar, air-traffic control, pager, and Personal Communication Services (PCS). These licensed services, along with unintentional radiators such as digital devices, including computer systems, contribute to the electromagnetic environment.

Electromagnetic Compatibility (EMC) is the ability of items of electronic equipment to function properly together in the electronic environment. While this computer system has been designed and determined to be compliant with regulatory agency limits for EMI, there is no guarantee that interference will not occur in a particular installation. If this equipment does cause interference with radio communications services, which can be determined by turning the equipment off and on, you are encouraged to try to correct the interference by one or more of the following measures:

- Reorient the receiving antenna.
- Relocate the computer with respect to the receiver.
- Move the computer away from the receiver.
- Plug the computer into a different outlet so that the computer and the receiver are on different branch circuits.

If necessary, consult a Regulatory EMC representative of Dell Computer Corporation or an experienced radio/television technician for additional suggestions. You may find the *FCC Interference Handbook, 1986*, to be helpful. It is available from the U.S. Government Printing Office, Washington, DC 20402, Stock No. 004-000-00450-7 or on the World Wide Web at <http://www.fcc.gov/Bureaus/Compliance/WWW/tvibook.html>.

Dell computer systems are designed, tested, and classified for their intended electromagnetic environment. These electromagnetic environment classifications generally refer to the following harmonized definitions:

- Class A is for business or industrial environments.
- Class B is for residential environments.

Information Technology Equipment (ITE), including peripherals, expansion cards, printers, input/output (I/O) devices, monitors, and so on, that are integrated into or connected to the system should match the electromagnetic environment classification of the computer system.

**A Notice About Shielded Signal Cables: Use only shielded cables for connecting peripherals to any Dell device to reduce the possibility of interference with radio communications services. Using shielded cables ensures that you maintain the appropriate EMC classification for the intended environment. For parallel printers, a cable is available from Dell Computer Corporation. If you prefer, you can order a cable from Dell Computer Corporation on the World Wide Web at <http://www.dell.com/products/dellware/index.htm>.**

**A Notice About Networked Computer Systems: Some Dell computer systems that are classified for Class B environments may include an on-board network interface controller (NIC). If your Class B system contains a NIC, it may be considered to be a Class A system at the time that the NIC is connected to a network. When the NIC is not connected to a network, your system is considered to be a Class B digital device.**

Most Dell computer systems are classified for Class B environments. To determine the electromagnetic classification for your system or device, refer to the following sections specific for each regulatory agency. Each section provides country-specific EMC/EMI or product safety information.

## **FCC Notices (U.S. Only)**

Most Dell computer systems are classified by the Federal Communications Commission (FCC) as Class B digital devices. However, the inclusion of certain options can change the rating of some configurations to Class A. To determine which classification applies to your computer system, examine all FCC registration labels located on the bottom or back panel of your computer, on card-mounting brackets, and on the cards themselves. If any one of the labels carries a Class A rating, your entire system is considered to be a Class A digital device. If *all* labels carry either the Class B rating distinguished by either an FCC ID number or the FCC logo, (**FCC**), your system is considered to be a Class B digital device.

Once you have determined your system's FCC classification, read the appropriate FCC notice. Note that FCC regulations provide that changes or modifications not expressly approved by Dell Computer Corporation could void your authority to operate this equipment.

This device complies with Part 15 of the FCC Rules. Operation is subject to the following two conditions:

- This device may not cause harmful interference.
- This device must accept any interference received, including interference that may cause undesired operation.

## **Class A**

This equipment has been tested and found to comply with the limits for a Class A digital device pursuant to Part 15 of the FCC Rules. These limits are designed to provide reasonable protection against harmful interference when the equipment is operated in a commercial environment. This equipment generates, uses, and can radiate radio frequency energy and, if not installed and used in accordance with the manufacturer's instruction manual, may cause harmful interference with radio communications. Operation of this equipment in a residential area is likely to cause harmful interference, in which case you will be required to correct the interference at your own expense.

## **Class B**

This equipment has been tested and found to comply with the limits for a Class B digital device pursuant to Part 15 of the FCC Rules. These limits are designed to provide reasonable protection against harmful interference in a residential installation. This equipment generates, uses, and can radiate radio frequency energy and, if not installed and used in accordance with the manufacturer's instruction manual, may cause interference with radio communications. However, there is no guarantee that interference will not occur in a particular installation. If this equipment does cause harmful interference to radio or television reception, which can be determined by turning the equipment off and on, you are encouraged to try to correct the interference by one or more of the following measures:

- Reorient or relocate the receiving antenna.
- Increase the separation between the equipment and the receiver.
- Connect the equipment into an outlet on a circuit different from that to which the receiver is connected.
- Consult the dealer or an experienced radio/television technician for help.

The following information is provided on the device or devices covered in this document in compliance with FCC regulations:

- Product name: Inspiron 7000
- Model number: PPI
- Company name: Dell Computer Corporation  
EMC Engineering Department  
One Dell Way  
Round Rock, Texas 78682 USA  
512-338-4400

## **Modem Regulatory Information**

This equipment complies with Part 68 of the FCC rules. On the bottom of your computer is a label that contains, among other information, the FCC registration number and ringer equivalence number (REN) for your equipment. If requested, you must provide this information to the telephone company.

The REN is used to determine the quantity of devices that may be connected to the telephone line. Excessive RENs on the telephone line may result in the devices not

ringing in response to an incoming call. In most areas, the sum of all the RENs on your telephone line should be less than five to ensure proper service from the telephone company. To be certain of the number of devices that you may connect to a line, as determined by the total RENs, contact your local telephone company.

The registration jack USOC used by this equipment is RJ-11C. An FCC compliant telephone cord and modular plug is provided with this equipment. This equipment is designed to be connected to the telephone network or premises wiring using a compatible modular jack that is Part 68 compliant.

This equipment cannot be used on public coin-phone service provided by the telephone company. Connection to party line service is subject to state tariffs.

There are no user serviceable parts on the modem contained in your computer.

If your telephone equipment causes harm to the telephone network, the telephone company will notify you in advance that service may be temporarily discontinued. If advance notice is not practical, the telephone company will notify you as soon as possible. Also, you will be advised of your right to file a complaint with the FCC if you believe it is necessary.

The telephone company may make changes in its facilities, equipment, operations, or procedures that could affect the operation of this equipment. If this happens, the telephone company will provide advance notice in order for you to make necessary modifications to maintain uninterrupted service.

If you experience trouble with this telephone equipment, refer to the chapter titled "Getting Help" in the *Reference and Troubleshooting Guide* or the section titled "Contacting Dell" in your *System User's Guide* to find the appropriate telephone number for obtaining customer assistance. If the equipment is causing harm to the telephone network, the telephone company may request that you disconnect the equipment until the problem is resolved.

### ***Fax Branding***

The Telephone Consumer Protection Act of 1991 makes it unlawful for any person to use a computer or other electronic device, including fax machines, to send any message unless such message clearly contains in a margin at the top or bottom of each transmitted page or on the first page of the transmission, the date and time it is sent, identification of the business, other entity, or individual sending the message, and the telephone number of the sending machine or such business, other entity, or individual. The telephone number provided may not be a 900 number or any other number for which charges exceed local or long-distance transmission charges.

## IC Notice (Canada Only)

Most Dell computer systems (and other Dell digital apparatus) are classified by the Industry Canada (IC) Interference-Causing Equipment Standard #3 (ICES-003) as Class B digital devices. To determine which classification (Class A or B) applies to your computer system (or other Dell digital apparatus), examine all registration labels located on the bottom or the back panel of your computer (or other digital apparatus). A statement in the form of "IC Class A ICES-3" or "IC Class B ICES-3" will be located on one of these labels. Note that Industry Canada regulations provide that changes or modifications not expressly approved by Dell Computer Corporation could void your authority to operate this equipment.

This Class B (or Class A, if so indicated on the registration label) digital apparatus meets the requirements of the Canadian Interference-Causing Equipment Regulations.

Cet appareil numérique de la Classe B (ou Classe A, si ainsi indiqué sur l'étiquette d'enregistrement) respecte toutes les exigences du Règlement sur le Matériel Brouilleur du Canada.

### Modem Regulatory Information

The IC label identifies certified equipment. This certification means that the equipment meets telecommunications network protective, operational, and safety requirements as prescribed in the appropriate Terminal Equipment Technical Requirements document(s). The IC label does not guarantee that the equipment will operate to the user's satisfaction.

Before installing this equipment, users should ensure that it is permissible to be connected to the facilities of the local telecommunications company. The equipment must also be installed using an acceptable method of connection. The customer should be aware that compliance with the above conditions may not prevent degradation of service in some situations.

Repairs to certified equipment should be coordinated by a representative designated by the supplier. Any repairs or alteration made by a user to this equipment, or equipment malfunctions, may give the telephone communications company cause to request the user to disconnect the equipment.

Users should ensure for their own protection, that the electrical ground connections of the power utility, telephone lines, and internal metallic water-pipe system, if present, are connected together. This precaution may be particularly important in rural areas.



**CAUTION: Users should not attempt to make such connections themselves. Contact the appropriate electric inspection authority, or electrician, as appropriate.**



*NOTE: The REN assigned to each terminal device provides an indication of the maximum number of terminals allowed to be connected to a telephone interface. The termination on an interface may consist of any combination of devices subject only to the requirement that the sum of the RENs of all the devices does not exceed the number five.*

The REN for the internal modem as stated on the IC regulatory label located on the bottom of the computer is 0.6B.

The following information is provided in compliance with IC regulations:

Dell Computer Corporation  
Warranty and Repair Service Center  
One Dell Way  
Round Rock, TX 78682 USA  
512-338-4400

## **CE Notice (European Union)**

Marking by the symbol **CE** indicates compliance of this Dell system to the EMC Directive and the Low Voltage Directive of the European Union. Such marking is indicative that this Dell system meets the following technical standards:

- EN 55022 — “Limits and Methods of Measurement of Radio Interference Characteristics of Information Technology Equipment.”
- EN 50082-1: 1992 — “Electromagnetic compatibility—Generic immunity standard Part 1: Residential, commercial, and light industry.”
- EN 60950 — “Safety of Information Technology Equipment.”



*NOTE: EN 55022 emissions requirements provide for two classifications:*

- *Class A is for typical commercial areas.*
- *Class B is for typical domestic areas.*



**WARNING: This is a Class A product. In a domestic environment this product may cause radio interference in which case the user may be required to take adequate measures.**

This Dell device is classified for use in a typical Class B domestic environment.

A “Declaration of Conformity” in accordance with the preceding directives and standards has been made and is on file at Dell Products Europe BV, Limerick, Ireland.

## **EN 55022 Compliance (Czech Republic Only)**

This device belongs to Class B devices as described in EN 55022, unless it is specifically stated that it is a Class A device on the specification label. The following applies to devices in Class A of EN 55022 (radius of protection up to 30 meters). The user of the device is obliged to take all steps necessary to remove sources of interference to telecommunication or other devices.

Pokud není na typovém štítku počítače uvedeno, že spadá do třídy A podle EN 55022, spadá automaticky do třídy B podle EN 55022. Pro zařízení zařazená do třídy A (ochranné pásmo 30m) podle EN 55022 platí následující. Dojde-li k rušení telekomunikačních nebo jiných zařízení, je uživatel povinen provést taková opatření, aby rušení odstranil.

## **VCCI Notice (Japan Only)**

Most Dell computer systems are classified by the Voluntary Control Council for Interference (VCCI) as Class B information technology equipment (ITE). However, the inclusion of certain options can change the rating of some configurations to Class A. ITE, including peripherals, expansion cards, printers, input/output (I/O) devices, monitors, and so on, integrated into or connected to the system, should match the electromagnetic environment classification (Class A or B) of the computer system.

To determine which classification applies to your computer system, examine the regulatory labels/markings (see Figures C-1 and C-2) located on the bottom or back panel of your computer. Once you have determined your system's VCCI classification, read the appropriate VCCI notice.

### **Class A ITE**

この装置は、情報処理装置等電波障害自主規制協議会 (VCCI) の基準に基づくクラス A 情報技術装置です。この装置を家庭環境で使用すると電波妨害を引き起こすことがあります。この場合には使用者が適切な対策を講ずるよう要求されることがあります。

This is a Class A product based on the standard of the Voluntary Control Council for Interference (VCCI) for information technology equipment. If this equipment is used in a domestic environment, radio disturbance may arise. When such trouble occurs, the user may be required to take corrective actions.

## **VCCI-A**

**Figure C-1. VCCI Class A ITE Regulatory Mark**



## Class B ITE

この装置は、情報処理装置等電波障害自主規制協議会 (VCCI) の基準に基づくクラス B 情報技術装置です。この装置は家庭環境で使用することを目的としていますが、この装置がラジオやテレビジョン受信機に近接して使用させると、受信障害を引き起こすことがあります。取扱説明書に従って正しい取り扱いをして下さい。

This is a Class B product based on the standard of the Voluntary Control Council for Interference (VCCI) for information technology equipment. If this equipment is used near a radio or television receiver in a domestic environment, it may cause radio interference. Install and use the equipment according to the instruction manual.



**Figure C-2. VCCI Class B ITE Regulatory Mark**

## MOC Notice (South Korea Only)

To determine which classification (Class A or B) applies to your computer system (or other Dell digital device), examine the South Korean Ministry of Communications (MOC) registration labels located on your computer (or other Dell digital device). The MOC label may be located separately from the other regulatory marking applied to your product. The English text, "EMI (A)," for Class A products, or "EMI (B)" for Class B products, appears in the center of the MOC label (see Figures C-3 and C-4).



*NOTE: MOC emissions requirements provide for two classifications:*

- *Class A devices are for business purposes.*
- *Class B devices are for nonbusiness purposes.*

## Class A Device

장치 종류	사용자 안내문
A 급 기기	이 장치는 업무용으로 전자파 적합등록을 한 장치이오니 판매자 또는 사용자는 이 점을 주의하시기 바라며 만약 잘못 판매 또는 구입하였을 때에는 가정용으로 교환하시기 바랍니다.

Please note that this device has been approved for business purposes with regard to electromagnetic interference. If you find that this device is not suitable for your use, you may exchange it for a nonbusiness device.

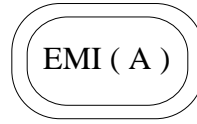
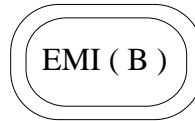

**Figure C-3. MOC Class A Regulatory Mark**

### **Class B Device**

장치 종류	사용자 안내문
B급 기기	이 장치는 가정용으로 전자파 적합등록을 한 장치로서 주거지역에서는 물론 모든 지역에서 사용할 수 있습니다.

Please note that this device has been approved for nonbusiness purposes and may be used in any environment, including residential areas.



**Figure C-4. MOC Class B Regulatory Mark**

## **Polish Center for Testing and Certification Notice**

The equipment should draw power from a socket with an attached protection circuit (a three-prong socket). All equipment that works together (computer, monitor, printer, and so on) should have the same power supply source.

The phasing conductor of the room's electrical installation should have a reserve short-circuit protection device in the form of a fuse with a nominal value no larger than 16 amperes (A).

To completely switch off the equipment, the power supply cable must be removed from the power supply socket, which should be located near the equipment and easily accessible.

A protection mark "B" confirms that the equipment is in compliance with the protection usage requirements of standards PN-93/T-42107 and PN-89/E-06251.

# **Wymagania Polskiego Centrum Badań i Certyfikacji**

Urządzenie powinno być zasilane z gniazda z przyłączonym obwodem ochronnym (gniazdo z kołkiem). Współpracujące ze sobą urządzenia (komputer, monitor, drukarka) powinny być zasilane z tego samego źródła.

Instalacja elektryczna pomieszczenia powinna zawierać w przewodzie fazowym rezerwową ochronę przed zwarciami, w postaci bezpiecznika o wartości znamionowej nie większej niż 16A (amperów).

W celu całkowitego wyłączenia urządzenia z sieci zasilania, należy wyjąć wtyczkę kabla zasilającego z gniazdka, które powinno znajdować się w pobliżu urządzenia i być łatwo dostępne.

Znak bezpieczeństwa "B" potwierdza zgodność urządzenia z wymaganiami bezpieczeństwa użytkowania zawartymi w PN-93/T-42107 i PN-89/E-06251.

## **Pozostałe instrukcje bezpieczeństwa**

- Nie należy używać wtyczek adapterowych lub usuwać kołka obwodu ochronnego z wtyczki. Jeżeli konieczne jest użycie przedłużacza to należy użyć przedłużacza 3-żyłowego z prawidłowo połączonym przewodem ochronnym.
- System komputerowy należy zabezpieczyć przed nagłymi, chwilowymi wzrostami lub spadkami napięcia, używając eliminatora przepięć, urządzenia dopasowującego lub bezzakłócenowego źródła zasilania.
- Należy upewnić się, aby nic nie leżało na kablach systemu komputerowego, oraz aby kable nie były umieszczone w miejscu, gdzie można byłoby na nie nadeptywać lub potykać się o nie.
- Nie należy rozlewać napojów ani innych płynów na system komputerowy.
- Nie należy wpychać żadnych przedmiotów do otworów systemu komputerowego, gdyż może to spowodować pożar lub porażenie prądem, poprzez zwarcie elementów wewnętrznych.
- System komputerowy powinien znajdować się z dala od grzejników i źródeł ciepła. Ponadto, nie należy blokować otworów wentylacyjnych. Należy unikać kładzenia luźnych papierów pod komputer oraz umieszczania komputera w ciasnym miejscu bez możliwości cyrkulacji powietrza wokół niego.

## **NOM Information (Mexico Only)**

The following information is provided on the device(s) described in this document in compliance with the requirements of the official Mexican standards (NOM)

Exporter:	Dell Computer Corporation One Dell Way Round Rock, TX 78682
Importer:	Dell Computer de México, S.A. de C.V. Rio Lerma No. 302 - 4° Piso Col. Cuauhtemoc 16500 México, D.F.
Ship to:	Dell Computer de México, S.A. de C.V. al Cuidado de Kuhne & Nagel de México S. de R.I. Avenida Soles No. 55 Col. Peñon de los Baños 15520 México, D.F.
Supply voltage:	115/230 VAC
Frequency:	60/50 Hz
Current consumption:	6.0/3.0 A

## **Información para NOM (únicamente para México)**

La información siguiente se proporciona en el dispositivo o en los dispositivos descritos en este documento, en cumplimiento con los requisitos de la Norma Oficial Mexicana (NOM):

Exportador:	Dell Computer Corporation One Dell Way Round Rock, TX 78682
Importador:	Dell Computer de México, S.A. de C.V. Río Lerma No. 302 - 4° Piso Col. Cuauhtemoc 16500 México, D.F.
Embarcar a:	Dell Computer de México, S.A. de C.V. al Cuidado de Kuehne & Nagel de México S. de R.l. Avenida Soles No. 55 Col. Peñon de los Baños 15520 México, D.F.
Tensión alimentación:	115/230 VAC
Frecuencia:	60/50 Hz
Consumo de corriente:	6.0/3.0 A

## ***BCIQ Notice (Taiwan Only)***

**警告使用者：**這是甲類的資訊產品，在居住的環境中使用時，可能會造成無線電干擾，在這種情況下，使用者會被要求採取某些適當的對策。



## **APPENDIX D**

# **Warranty, Return Policy, and Year 2000 Statement of Compliance**

### **Limited Three-Year Warranty (U.S. and Canada Only)**

Dell Computer Corporation ("Dell") manufactures its hardware products from parts and components that are new or equivalent to new in accordance with industry-standard practices. Dell warrants that the hardware products it manufactures will be free from defects in materials and workmanship. The warranty term is three years beginning on the date of invoice, as described in the following text.

Damage due to shipping the products to you is covered under this warranty. Otherwise, this warranty does not cover damage due to external causes, including accident, abuse, misuse, problems with electrical power, servicing not authorized by Dell, usage not in accordance with product instructions, failure to perform required preventive maintenance, and problems caused by use of parts and components not supplied by Dell.

This warranty does not cover any items that are in one or more of the following categories: software; external devices (except as specifically noted); accessories or parts added to a Dell system after the system is shipped from Dell; accessories or parts added to a Dell system through Dell's system integration department; accessories or parts that are not installed in the Dell factory; or DellWare products. Monitors, keyboards, and mice that are Dell-branded or that are included on Dell's standard price list are covered under this warranty; all other monitors, keyboards, and mice (including those sold through the DellWare program) are not covered. Batteries for portable computers are covered only during the initial one-year period of this warranty.

#### **Coverage During Year One**

During the one-year period beginning on the invoice date, Dell will repair or replace products covered under this limited warranty that are returned to Dell's facility. To request warranty service, you must call Dell's Customer Technical Support within the warranty period. Refer to the chapter titled "Getting Help" in your *Reference and Troubleshooting Guide* or, the section titled "Contacting Dell" in your *System User's Guide*

to find the appropriate telephone number for obtaining customer assistance. If warranty service is required, Dell will issue a Return Material Authorization Number. You must ship the products back to Dell in their original or equivalent packaging, prepay shipping charges, and insure the shipment or accept the risk of loss or damage during shipment. Dell will ship the repaired or replacement products to you freight prepaid if you use an address in the continental U.S. or Canada, where applicable. Shipments to other locations will be made freight collect.



*NOTE: Before you ship the product(s) to Dell, back up the data on the hard-disk drive(s) and any other storage device(s) in the product(s). Remove any removable media, such as diskettes, CDs, or PC Cards. Dell does not accept liability for lost data or software.*

Dell owns all parts removed from repaired products. Dell uses new and reconditioned parts made by various manufacturers in performing warranty repairs and building replacement products. If Dell repairs or replaces a product, its warranty term is not extended.

### **Coverage During Years Two and Three**

During the second and third years of this limited warranty, Dell will provide, on an exchange basis and subject to Dell's Exchange Policy in effect on the date of the exchange, replacement parts for the Dell hardware product(s) covered under this limited warranty when a part requires replacement. You must report each instance of hardware failure to Dell's Customer Technical Support in advance to obtain Dell's concurrence that a part should be replaced and to have Dell ship the replacement part. Dell will ship parts (freight prepaid) if you use an address in the continental U.S. or Canada, where applicable. Shipments to other locations will be made freight collect. Dell will include a prepaid shipping container with each replacement part for your use in returning the replaced part to Dell. Replacement parts are new or reconditioned. Dell may provide replacement parts made by various manufacturers when supplying parts to you. The warranty term for a replacement part is the remainder of the limited warranty term.

You will pay Dell for replacement parts if the replaced part is not returned to Dell. The process for returning replaced parts, and your obligation to pay for replacement parts if you do not return the replaced parts to Dell, will be in accordance with Dell's Exchange Policy in effect on the date of the exchange.

You accept full responsibility for your software and data. Dell is not required to advise or remind you of appropriate backup and other procedures.

### **General Provisions**

DELL MAKES NO EXPRESS WARRANTIES OR CONDITIONS BEYOND THOSE STATED IN THIS WARRANTY STATEMENT. DELL DISCLAIMS ALL OTHER WARRANTIES AND CONDITIONS, EXPRESS OR IMPLIED, INCLUDING WITHOUT LIMITATION IMPLIED WARRANTIES AND CONDITIONS OF MERCHANTABILITY AND FITNESS FOR A PARTICULAR PURPOSE. SOME STATES (OR JURISDICTIONS) DO NOT ALLOW LIMITATIONS ON IMPLIED WARRANTIES OR CONDITIONS, SO THIS LIMITATION MAY NOT APPLY TO YOU.

DELL'S RESPONSIBILITY FOR MALFUNCTIONS AND DEFECTS IN HARDWARE IS LIMITED TO REPAIR AND REPLACEMENT AS SET FORTH IN THIS WARRANTY STATEMENT. THESE WARRANTIES GIVE YOU SPECIFIC LEGAL RIGHTS, AND YOU MAY ALSO HAVE OTHER RIGHTS, WHICH VARY FROM STATE TO STATE (OR JURISDICTION TO JURISDICTION).

DELL DOES NOT ACCEPT LIABILITY BEYOND THE REMEDIES SET FORTH IN THIS WARRANTY STATEMENT OR LIABILITY FOR INCIDENTAL OR CONSEQUENTIAL DAMAGES, INCLUDING WITHOUT LIMITATION ANY LIABILITY FOR PRODUCTS NOT BEING AVAILABLE FOR USE OR FOR LOST DATA OR SOFTWARE.

SOME STATES (OR JURISDICTIONS) DO NOT ALLOW THE EXCLUSION OR LIMITATION OF INCIDENTAL OR CONSEQUENTIAL DAMAGES, SO THE PRECEDING EXCLUSION OR LIMITATION MAY NOT APPLY TO YOU.

These provisions apply to Dell's limited three-year warranty only. For provisions of any service contract covering your system, refer to your invoice or the separate service contract that you will receive.

If Dell elects to exchange a system or component, the exchange will be made in accordance with Dell's Exchange Policy in effect on the date of the exchange. In any instance in which Dell issues a Return Materials Authorization Number, Dell must receive the product(s) for repair prior to the expiration of the warranty period in order for the repair(s) to be covered by the warranty.



*NOTE: If you chose one of the available warranty and service options in place of the standard limited three-year warranty described in the preceding text, the option you chose will be listed on your invoice.*

## **“Total Satisfaction” Return Policy (U.S. and Canada Only)**

If you are an end-user customer who bought new products directly from a Dell company, you may return them to Dell within 30 days of the date of invoice for a refund or credit of the product purchase price. If you are an end-user customer who bought reconditioned or refurbished products from a Dell company, you may return them to Dell within 14 days of the date of invoice for a refund or credit of the product purchase price. In either case, the refund or credit will not include any shipping and handling charges shown on your invoice. If you are an organization that bought the products under a written agreement with Dell, the agreement may contain different terms for the return of products than specified by this policy.

To return products, you must call Dell Customer Service to receive a Credit Return Authorization Number. Refer to the chapter titled "Getting Help" in your *Reference and Troubleshooting Guide* or the section titled "Contacting Dell" in your *System User's Guide* to find the appropriate telephone number for obtaining customer assistance. To expedite the processing of your refund or credit, Dell expects you to return the products to Dell in their original packaging within five days of the date that Dell issues the Credit Return Authorization Number. You must also prepay shipping charges and insure the shipment or accept the risk of loss or damage during shipment. You may



return software for refund or credit only if the sealed package containing the diskette(s) or CD(s) is unopened. Returned products must be in as-new condition, and all of the manuals, diskette(s), CD(s), power cables, and other items included with a product must be returned with it. For customers who want to return, for refund or credit only, either applications software or an operating system that has been installed by Dell, the whole system must be returned, along with any media and documentation that may have been included in the original shipment.

This "Total Satisfaction" Return Policy does not apply to DellWare products, which may be returned under DellWare's then-current return policy. In addition, reconditioned parts purchased through Dell Spare Parts Sales in Canada are nonreturnable.

## **Year 2000 Statement of Compliance for Dell-Branded Hardware Products**

Dell-branded hardware products shipped on or after January 1, 1997, are eligible to carry the "NSTL Hardware Tested Year 2000 Compliant" logo by virtue of formal testing with, and successful completion of, the National Software Testing Laboratories (NSTL) YMARK2000 test.\* Dell will treat a failure to pass the YMARK2000 test as a covered event under Dell's warranty for the product, subject to the normal warranty limitations.\*\* For a complete copy of Dell's warranty, see the product's documentation. Dell-branded hardware products will also recognize the year 2000 as a leap year.

\*The YMARK2000 standard tests the ability of system hardware and firmware to support the transition to the year 2000 (and to recognize leap years, when appropriate, for years 2000 through 2009 inclusive) and not that of options, operating systems, or applications software. Dell-branded hardware products that pass the YMARK2000 test conform to BSI-DISC PD 2000-1.

\*\* Except for this clarification of Dell's warranty for NSTL logo hardware, all other warranties, conditions and remedies, express or implied, relating to year 2000 readiness or compliance are disclaimed. To make a claim under this warranty for NSTL logo hardware, customers must contact Dell prior to January 1, 2001. Despite a system's ability to pass the YMARK2000 test, actual rollover results in specific operating environments may vary depending on other factors including, but not limited to, other hardware, operating systems, and applications software.

### **Previous Products**

For Dell-branded hardware products shipped prior to January 1, 1997, that have an upgradable basic input/output system (BIOS), Dell makes available a BIOS upgrade. Although these products may not have been tested under the YMARK2000 test, Dell believes that the hardware would pass the YMARK2000 test, provided the appropriate BIOS upgrade is properly loaded.

For Dell-branded hardware products that do not have an upgradable BIOS, Dell has made available, as a convenience to customers, the Dell Program Patch, a software utility designed to assist customers in managing the year 2000 rollover.

## **Software**

Dell specifically excludes all non-Dell-developed software from this compliance statement. All software run on Dell-branded hardware products should be independently verified by customers to be year 2000-compliant.

## **Additional Information**

For additional information on year 2000 compliance of Dell-branded hardware products, refer to Dell's Year 2000 Web site at [www.dell.com/year2000](http://www.dell.com/year2000) or contact a Dell customer service representative in your area.





# Index

## A

- About
  - option in Dell Diagnostics, 4-11
- AC adapter connector, 1-3
- alternating current. *See* AC
- assistance
  - technical, 5-1
  - telephone numbers, 5-7
  - warranty repair or credit, 5-5
- audio functions
  - troubleshooting, 3-34
- audio jacks, 1-3
- Audio test group
  - Dell Diagnostics, 4-26
- AutoTech service, 5-3

## B

- basic input/output system. *See* BIOS
- battery, 1-4
- beep codes
  - See also* error messages
  - about, 3-8
- BIOS, 1-4
- boot device
  - selecting, 2-11

- boot routine
  - indications, 3-5
- booting the computer, 2-11

## C

- cables
  - troubleshooting, 3-3
- cache memory, 1-4
- calling Dell, 5-7
- card. *See* PC Cards
- cautions, xiii
- CD-ROM drive
  - about, 1-3
  - troubleshooting, 3-21
- central processing unit (CPU). *See* microprocessor
- computer
  - customizing features, 2-1
  - features, 1-3
  - technical specifications, A-1
  - traveling with, v
- connectors
  - location, 1-3
  - troubleshooting, 3-3
- cords. *See* cables
- CPU. *See* microprocessor
- customizing computer features, 2-1

## **D**

Dell Diagnostics  
  about, 4-1  
  Audio test group, 4-26  
  before starting, 4-2  
  diagnostic video tests, B-1  
  Diagnostics Menu, 4-3  
  Diskette Drives test group, 4-21  
  error messages, 4-14  
  features, 4-1  
  IDE (ATA/ATAPI) devices test group, 4-22  
  Keyboard test group, 4-19  
  main screen, 4-5  
  Mouse test group, 4-20  
  Parallel Ports test group, 4-24  
  quitting, 4-12  
  RAM test group, 4-14  
  Serial/Infrared Ports test group, 4-23  
  starting, 4-3  
  system configuration information, 4-5  
  System Set test group, 4-15  
  tests, 4-12  
  using, 4-4  
  Video test group, 4-17  
  video tests, B-1  
  when to use, 4-2

Dell Inspiron 7000 Port Replicator, 1-6

device drivers. *See* drivers

diagnosing problems, 5-1

diagnostic video tests, B-1

Diagnostics Checklist, 5-6

diagnostics. *See* Dell Diagnostics

disk. *See* diskette drive, hard-disk drive, CD-ROM drive, DVD-ROM drive

diskette drive  
  failure during POST, 3-20  
  location, 1-2  
  testing, 4-21

Diskette Drives test group  
  Dell Diagnostics, 4-21

diskettes  
  program, 2-14

display  
  about, 1-2, 1-3  
  location, 1-2  
  troubleshooting, 3-27

display close/suspend button, 1-2

display latch, 1-2

drivers  
  about, 2-14  
  as source of program conflicts, 3-12  
  reinstalling, 2-14

dropped or damaged computer, 3-15

DVD-ROM drive, 1-3

## **E**

ECP-compatible devices, 2-6

electrostatic discharge. *See* ESD

error messages  
  beep codes, 3-9  
  Dell Diagnostics, 4-14  
  system error messages, 3-6  
  table, 3-6

ESD, ix

Extended Capabilities Port. *See* ECP  
  ECP

extended graphics array. *See* XGA  
  display

## **F**

failures  
  basic checks, 3-2  
  troubleshooting, 3-1

fixed disk. *See* hard-disk drive

fixing problems, 5-1

floppy drive. *See* diskette drive

## **G**

getting help, 5-1  
graphics mode screens, B-5  
grounding procedure, viii, 3-1

## **H**

hard drive. *See* hard-disk drives  
hard-disk drives  
    about, 1-5  
    ATA, 1-5  
    capacity, 2-4  
    power management, 2-10  
    testing, 4-22  
    troubleshooting, 3-22  
    Ultra DMA/33, 1-5  
help tools  
    AutoTech service, 5-3  
    Dell Diagnostics program, 4-1  
    Internet, 5-2  
    TechConnect BBS, 5-4  
    TechFax service, 5-3  
    user's documentation, 5-2  
hung system, 1-5

## **I**

I/O  
    connectors, 1-3  
    troubleshooting functions, 3-32  
IDE (ATA/ATAPI) devices test group  
    Dell Diagnostics, 4-22  
indicator light, 1-2  
infrared port  
    about, 1-5  
    location, 1-3  
    mapping, 2-6  
    mode selection, 2-6  
    troubleshooting, 3-33

input/output. *See* I/O  
Internet help tools, 5-2  
interrupt assignment conflicts, 3-12  
interrupt request. *See* IRQ  
IRQ line assignment, 3-12

## **K**

keyboard  
    about, 1-2  
    checking external keyboard during  
        POST, 3-23  
    Keyboard test group in Dell  
        Diagnostics, 4-19  
Keyboard test group  
    Dell Diagnostics, 4-19  
Key-Help  
    option in Dell Diagnostics, 4-12

## **L**

lithium ion battery, 1-4

## **M**

main battery, 1-2  
memory  
    failure during POST, 3-25  
    RAM test group in Dell Diagnostics,  
        4-14  
menu options  
    Dell Diagnostics, 4-6  
messages  
    beep codes, 3-8  
    Dell Diagnostics, 4-1, 4-14  
    error messages, 3-11  
    system messages, 3-6  
microphone, 1-2

- microprocessor
  - about, 1-3
  - slowing the microprocessor, 2-9
  - speed, 1-3
- monitor (external)
  - errors during POST, 3-28
- monitor connector, 1-5
- mouse, 1-5
- Mouse test
  - Dell Diagnostics, 4-20
- MPEG 2, 2-6

## **N**

- nonvolatile random-access memory. *See* NVRAM
- notational conventions, xiii
- notes, xiii
- NVRAM, 2-2

## **O**

- operating systems
  - reinstalling, 2-14
- Options
  - option in Dell Diagnostics, 4-8
- options, 1-6
- options bay, 1-2, 1-4

## **P**

- parallel port
  - disabling, 2-6
  - mapping, 2-6
  - troubleshooting, 3-29
- Parallel Ports test group
  - Dell Diagnostics, 4-24

- parallel printer
  - troubleshooting, 3-31
- passwords. *See* system password
- PC Card slot, 1-3
- PC Cards, 1-4
- PCMCIA cards. *See* PC Cards
- Personal System/2. *See* PS/2
- ports. *See* parallel port, serial port, infrared port

## POST

- CD-ROM drive check, 3-21
- diskette drive check, 3-20
- external keyboard check, 3-23
- external monitor check, 3-28
- hard-disk drive check, 3-22
- memory check, 3-25
- power button, 1-2, 1-5
- power failure
  - AC power, 3-17
  - battery power, 3-18
  - cable connections, 3-3
  - partial, 3-19
  - troubleshooting, 3-16
- power management
  - modes, 1-4
  - save-to-disk suspend mode, 1-4
  - standby mode, 1-4
- problems
  - help tools, 5-1
  - troubleshooting, 3-1
  - with your order, 5-4

- processor. *See* microprocessor

- product information, 5-4

- program. *See* system utilities

## PS/2

- connector, 1-5

## **Q**

### Quit

- option in Dell Diagnostics, 4-12

## **R**

- RAM count failure during POST, 3-25
- RAM test group
  - in Dell Diagnostics, 4-14
- regulatory notices, C-2
- reinstalling
  - drivers and utilities, 2-14
- return policy, D-3
- returns, 5-5
- Run
  - option in Dell Diagnostics, 4-6

## **S**

- safety instructions
  - ESD prevention, ix
  - general, v
  - working inside your computer, viii
- save-to-disk suspend file, 2-16
- save-to-disk suspend mode, 1-4
- security
  - cable slot
  - key lock, 1-2
  - system password, 2-7
- Select
  - option in Dell Diagnostics, 4-7
- serial devices
  - troubleshooting, 3-32
- serial port
  - mapping, 2-6
  - troubleshooting, 3-29
- Serial/Infrared Ports test group
  - Dell Diagnostics, 4-23
- service, 5-1
- Setup messages, 2-2

- Setup program
  - accessing, 2-3
  - Exit menu options, 2-11
  - Main menu options, 2-3
  - Power menu options, 2-8
  - Security menu options, 2-7
  - System Devices menu options, 2-5
- shutting down the computer, 1-5
- software
  - apparent malfunction, 4-14
  - corrupted, 2-14
  - drivers, 2-14, 3-12
  - error messages, 3-11
  - included with computer, 1-5
  - installing and configuring, 3-10
  - memory-resident programs, 3-11
  - problems, 3-10
  - program conflicts, 3-12
  - reinstalling, 2-14
  - start-up files, 3-11
  - system utilities, 2-1
  - troubleshooting errors, 3-10
  - using, 3-11
  - virus scans, 3-10
- speakers
  - location, 1-2
- specifications
  - technical, A-1
- standby mode, 1-4
- start-up files, 3-11
- Subtest
  - option in Dell Diagnostics, 4-7
- support
  - technical, 5-1
- system
  - features, 1-3
  - specifications, A-1
- system configuration information
  - about, 2-2
  - confirming with Dell Diagnostics, 4-5



- System Date option
  - Setup program, 2-4
- system error messages
  - See also* error messages
  - about, 3-6
- system memory, 1-4
- system password
  - assigning or changing, 2-7
- System Set test group
  - Dell Diagnostics, 4-15
- system software
  - reinstalling, 2-14
- system utilities, 2-1

## **T**

- TechConnect BBS, 5-4
- TechFax service, 5-3
- technical assistance
  - obtaining, 5-1
  - warranty repair or credit, 5-5
- technical specifications, A-1
- terminate-and-stay-resident. *See* TSR
- Test Limits
  - option in Dell Diagnostics, 4-11
- touch pad
  - about, 1-5
  - location, 1-2
  - testing, 4-20
  - troubleshooting, 3-33
- troubleshooting
  - about, 3-1
  - AC power failure, 3-17
  - audible signs of problems, 3-5
  - audio functions, 3-34
  - basic problems, 3-2
  - battery power failure, 3-18
  - beep codes, 3-8
  - CD-ROM drive, 3-21
  - checking connections, 3-3

- troubleshooting (*continued*)
  - Diagnostics Checklist, 5-6
  - diskette drive failure during POST, 3-20
  - display failure, 3-27
  - dropped or damaged computer, 3-15
  - DVD-ROM drive, 3-21
  - external keyboard, 3-23
  - external monitor, 3-28
  - failure during RAM count, 3-25
  - hard-disk drive failure during POST, 3-22
  - I/O functions, 3-30
  - infrared port, 3-33
  - Internet tools, 5-2
  - IRQ conflicts, 3-12
  - messages, 3-6
  - monitor, 3-28
  - parallel port, 3-29
  - parallel printer, 3-31
  - partial power failure, 3-19
  - serial devices, 3-32
  - serial port, 3-29
  - software errors, 3-10
  - starting, 3-2
  - touch pad, 3-33
  - water damage, 3-13
- TSR programs
  - about, 3-10
  - problems with, 3-11
- turning off the computer, 1-5
- turning on the computer, 1-5
- typographical conventions, xiii

## **U**

- Universal Serial Bus. *See* USB
- upgrade options, 1-6
- USB, 1-5
- user's documentation, xii, 5-2
- utilities
  - reinstalling, 2-14

## **V**

- video control circuitry, 4-17
- video controller, 4-17
- video display, 1-3
- video functions
  - about, B-1
  - testing, 4-17
- video memory, A-3
- video subsystem. *See* Video test group
- Video test group
  - Dell Diagnostics, 4-17
- video tests
  - Color Palettes Test, B-7
  - Graphics Mode Test, B-5
  - Solid Colors Test, B-8
  - Text Mode Character Test, B-2
  - Text Mode Color Test, B-4
  - Text Mode Pages Test, B-5
  - Video Hardware Test, B-2
  - Video Memory Test, B-2

## **W**

- warnings, xiii
- warranty information, xii, D-1
- warranty repair or credit, 5-5
- water damage, 3-13
- World Wide Web help tools, 5-2

## **X**

- XGA display, 1-3