

Thank you for purchasing this Factory Service Manual CD/DVD from servicemanuals4u.com.

Please check out our eBay auctions for more great deals on Factory Service Manuals:

[servicemanuals4u](http://servicemanuals4u.com)

Dell™ Inspiron™ 4000

[A Tour of Your Computer](#)

[Conserving Power](#)

[System Specifications](#)

[Solving Problems](#)

[Drivers and Utilities for Microsoft® Windows® 98](#)

[Drivers and Utilities for Microsoft® Windows® Millennium Edition \(Me\)](#)

[Drivers and Utilities for Microsoft® Windows® 2000](#)

[System Setup Program](#)

[Ports and Connector Pin-Outs](#)

[Removing and Replacing Parts](#)

Hints, Notices, and Cautions



HINT: A HINT indicates important information that helps you make better use of your computer.



NOTICE: A NOTICE indicates either potential damage to hardware or loss of data and tells you how to avoid the problem.



CAUTION: A CAUTION indicates a potential for property damage, personal injury, or death.

Abbreviations and Acronyms

For a complete listing of abbreviations and acronyms, see the Glossary in the *Tell Me How* help file (click the **Start** button, point to **Programs—> User's Guides**, and then click **Tell Me How**).

Information in this document is subject to change without notice.

© 2000–2001 Dell Computer Corporation. All rights reserved.

Reproduction in any manner whatsoever without the written permission of Dell Computer Corporation is strictly forbidden.

Trademarks used in this text: *Dell*, the *DELL* logo, and *Inspiron* are trademarks of Dell Computer Corporation; *Intel* and *Pentium* are registered trademarks and *Celeron* is a trademark of Intel Corporation; *Microsoft* and *Windows* are registered trademarks of Microsoft Corporation.

Other trademarks and trade names may be used in this document to refer to either the entities claiming the marks and names or their products. Dell Computer Corporation disclaims any proprietary interest in trademarks and trade names other than its own.

This product incorporates copyright protection technology that is protected by method claims of certain U.S. patents and other intellectual property rights owned by Macrovision Corporation and other rights owners. Use of this copyright protection technology must be authorized by Macrovision Corporation, and is intended for home and other limited viewing uses only unless otherwise authorized by Macrovision Corporation. Reverse engineering or disassembly is prohibited.

August 2001 Rev. A03

[Back to Contents Page](#)

A Tour of Your Computer

Dell™ Inspiron™ 4000

- [Front View](#)
- [Left Side View](#)
- [Right Side View](#)
- [Back View](#)

Front View

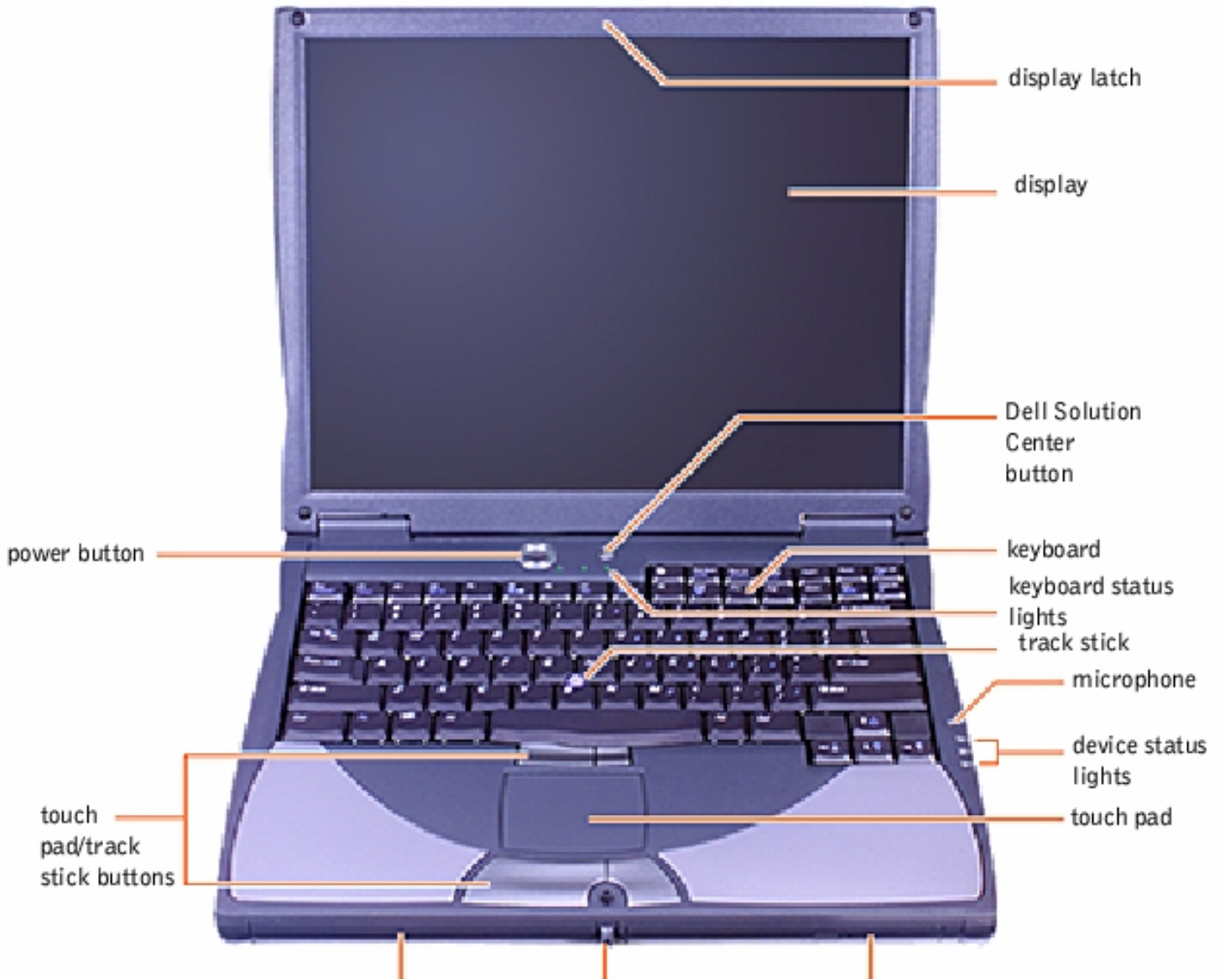

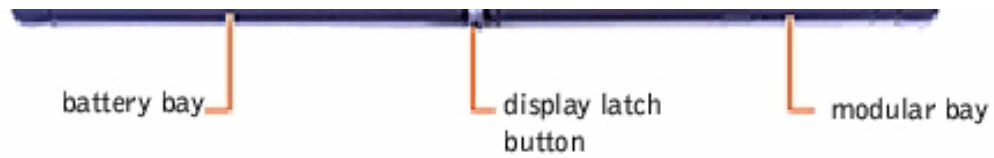

Display Latch

This latch keeps the display locked in place when the display is closed.

Display

The computer has a color LCD.

Dell™ Solution Center Button

Press this button to launch the Dell Solution Center, where you can find support and educational tools that Dell has installed on your computer. You can reprogram the button to launch a program of your choice.

Keyboard Status Lights



The green lights located above the keyboard indicate the following:

- The light labeled  turns on when you press  to enable the numeric keypad.
- The light labeled  turns on when you press  to enable the uppercase letter function.
- The light labeled  turns on when you press   to enable the scroll lock function.

Keyboard

The keyboard includes a numeric keypad as well as the Microsoft® Windows® logo key that supports the Windows operating systems.

Track Stick

The track stick detects the pressure and movement of your finger for moving the cursor on the display and, along with the track stick buttons, provides full mouse functionality.



Microphone



The internal microphone allows you to record voice audio.

Device Status Lights



The green lights next to the keyboard indicate the following:

- The light labeled  turns on when the computer is turned on and blinks when the computer is in standby mode.
- The light labeled  turns on when the computer reads data from or writes data to the hard drive.
- The light labeled  turns on steadily or blinks to indicate the battery charge status. Indicator states include:
 - Off, which indicates that the computer is operating on AC power
 - Flashing green, which indicates that the battery is charging
 - Solid green, which indicates that the battery is fully charged

 **NOTICE:** To avoid data loss, never turn off the computer while the green light labeled  is flashing.

Touch Pad

The touch pad detects the position of your finger over a touch-sensitive area and provides the computer with full mouse functionality.

Modular Bay

You can install devices such as a floppy drive, CD drive, DVD drive, CD- RW drive, Zip drive, second hard drive, second battery, or Dell TravelLite™ travel module in the modular bay.

Display Latch Button

Press the display latch button to unlock the display.

Battery Bay

With a battery in this bay, you can use the computer without plugging it into the electrical outlet.

Touch Pad/Track Stick Buttons

These buttons correspond to the left and right buttons on a standard mouse.

Power Button

 **HINT:** To turn off your computer, perform a Windows shutdown.

Press the power button to turn on the computer or to initiate standby mode.

If the computer stops responding, press and hold the power button until the computer turns off completely (this may take several seconds).

Left Side View

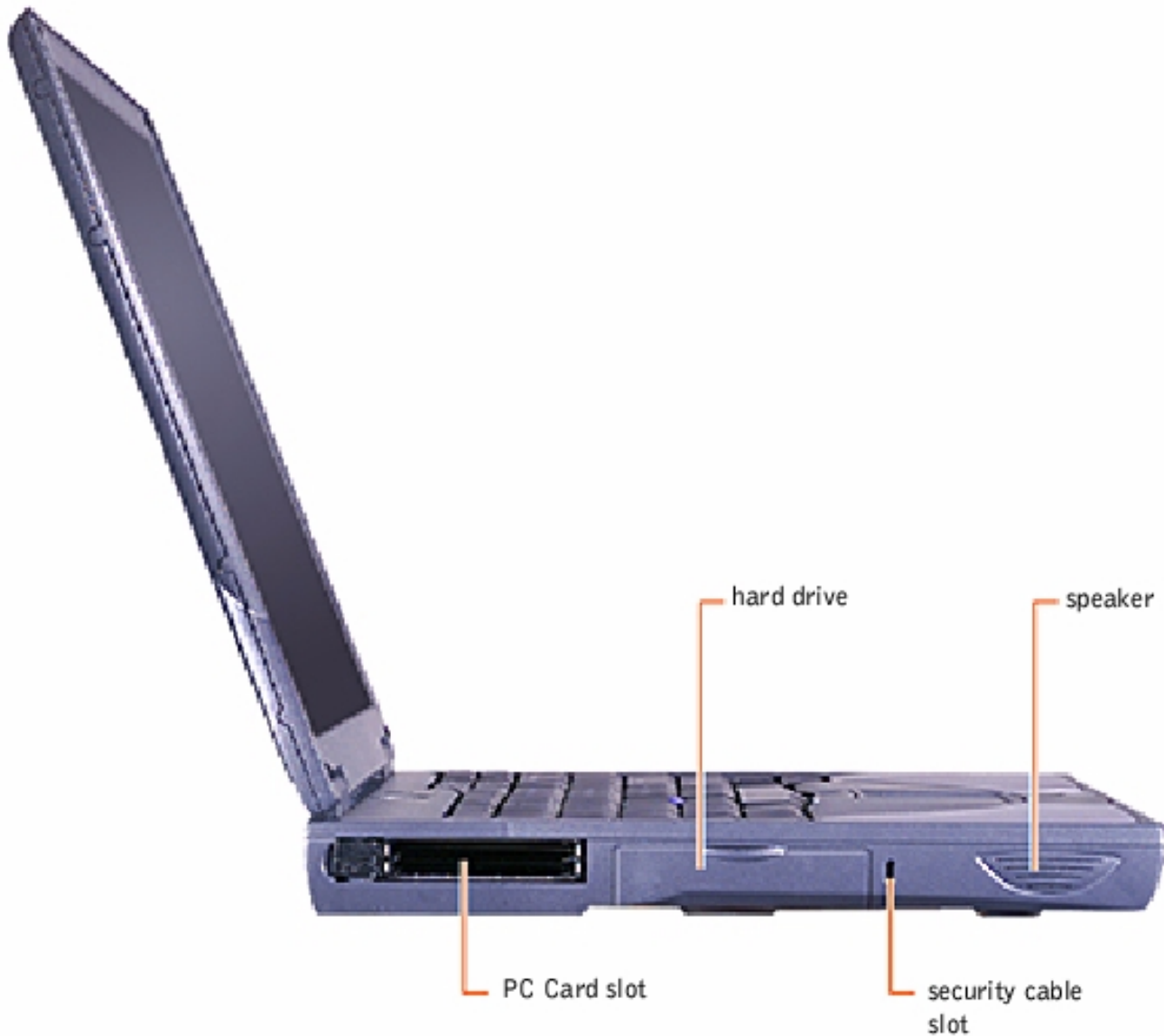

PC Card Slot

The PC Card slot has two connectors that support various types of PC Cards, including modems and network adapters.

Hard Drive

The hard drive reads and writes data on a hard disk.

Security Cable Slot

This slot lets you attach a commercially available antitheft device to the computer. Complete instructions for installing antitheft devices are usually included with the device.



NOTICE: Antitheft devices are of differing designs. Before you buy one, make sure it works with the security cable slot in the computer.

Speakers

Your computer has integrated speakers.

Right Side View

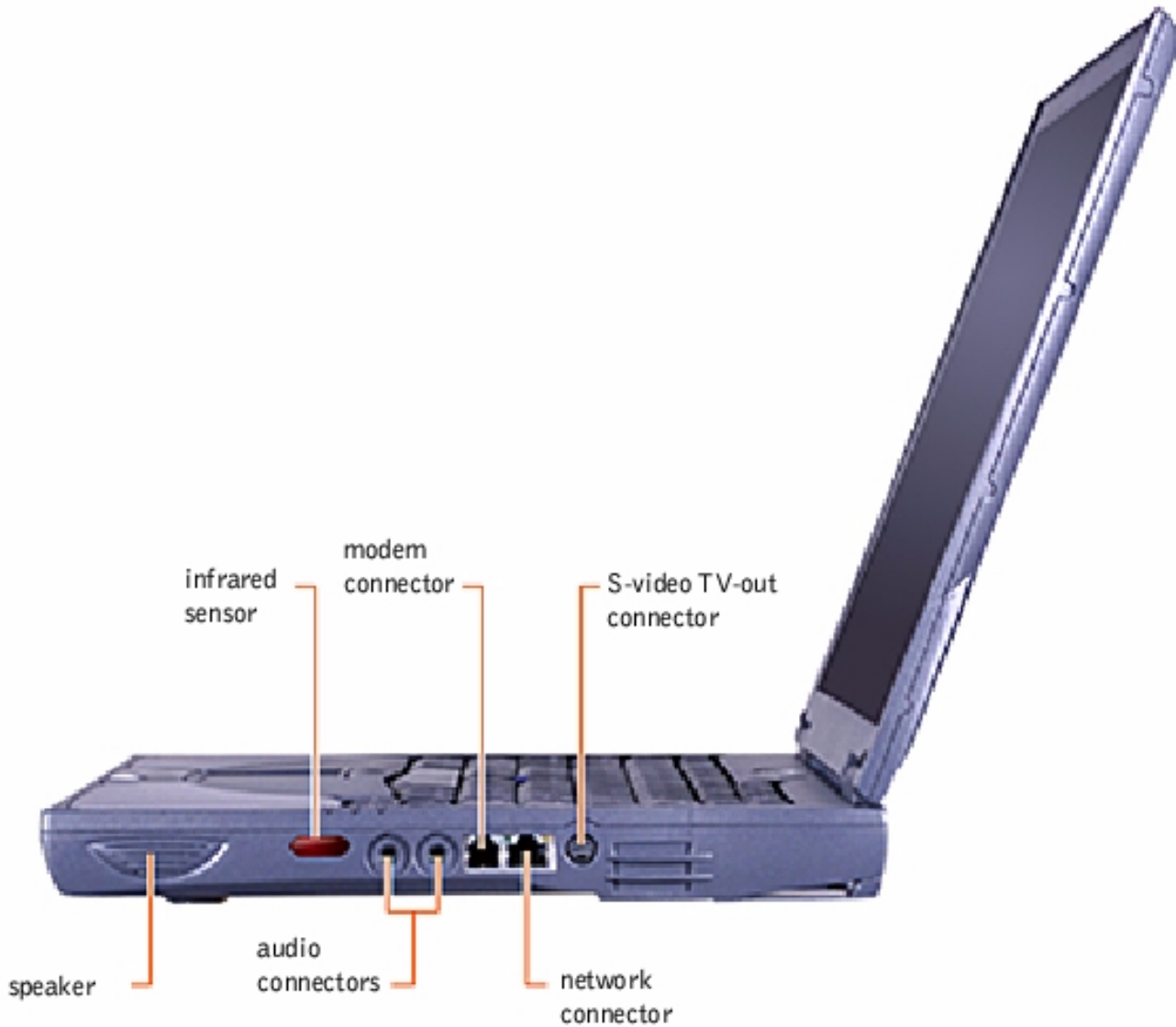

Infrared Sensor

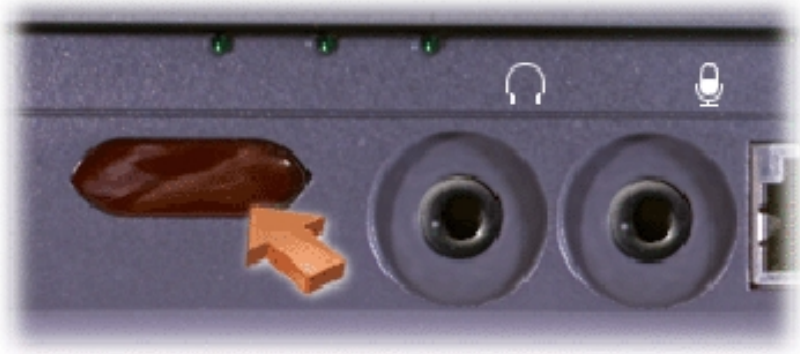

 **HINT:** The infrared sensor does not function when the computer is connected to a port replicator.

The infrared sensor lets you transfer files from the computer to another infrared device without using cable connections.



Audio Connectors



- Attach a microphone to the  connector.
- Attach headphones or speakers to the  connector.

Modem Connector



If you ordered the optional internal modem, use this connector to plug in the telephone connector.

Network Connector

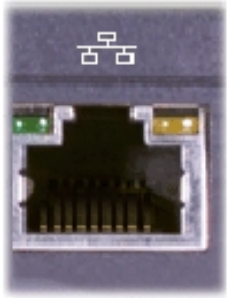

If you ordered the optional network adapter, use this connector to connect the computer to a network.

S-Video TV-Out Connector



Use this connector to connect your computer to a television.

Fan Exhaust

The fan works with the air intake to prevent the computer from overheating. When the computer gets hot, the small internal fan turns on and draws air through the air intake to cool the computer. Hot air is expelled through the fan exhaust.

Back View

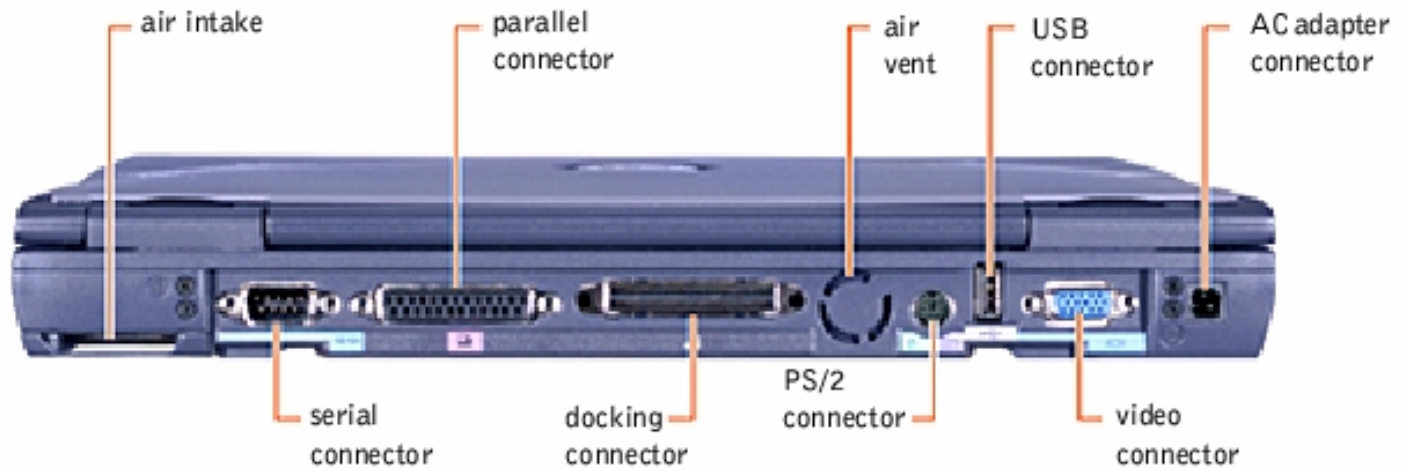

Air Intake

 **HINT:** The computer turns on the fan only when the computer gets hot. It may run most of the time or very seldom, depending on your use of the computer. Because the fan spins at a high rate of speed, it may make a noise. This noise is normal and does not indicate a problem with the fan or the computer.

The fan works with the air intake to prevent the computer from overheating. When the computer gets hot, the small internal fan turns on and draws air through the air intake to cool the computer. Hot air is expelled through the fan exhaust.

 **CAUTION:** Do not push objects into or block the air intake. Doing so can cause fire or damage the interior components. Keep the opening free from dust and other foreign particles.

Serial Connector

Use this connector to attach a serial device to the computer.



Parallel Connector

Use this connector to attach a parallel device, such as a printer, to the computer.



Docking Connector



Use this connector to attach your computer to the optional advanced port replicator. An advanced port replicator allows you to easily use an external keyboard, mouse, and monitor with your computer. It also includes a network connector for connecting your computer to a network.

 **HINT:** The port replicator may not be available in certain countries.

Refer to the documentation that came with your port replicator for instructions on attaching external devices to the port replicator and connecting your computer to it.

PS/2 Connector



Use this connector to attach PS/2-compatible devices such as a mouse, keyboard, or external numeric keypad to your computer.

USB Connector



Use this connector to attach USB-compatible devices such as a mouse, keyboard, printer, or scanner to your computer.

Video Connector



Use this connector to attach an external monitor to the computer.

AC Adapter Connector

Use this connector to attach an AC adapter to the computer.



 **HINT:** Although the AC adapter works worldwide, power connectors vary among countries. Before using the AC adapter in a foreign country, you may need to obtain a new power cable designed for use with the electrical outlets in that country.

The AC adapter converts AC power to the DC power required by the computer. You can connect the AC adapter with your computer either turned on or off.

 **NOTICE:** When you disconnect the AC adapter from the computer, grasp the adapter cable connector, not the cable itself, and pull firmly but gently to avoid damaging the cable.

[Back to Contents Page](#)

[Back to Contents Page](#)

Conserving Power

Dell™ Inspiron™ 4000

- [Conservation Tips](#)
 - [Power Conservation Modes](#)
 - [Power Options Properties](#)
-

Conservation Tips

- You automatically conserve battery power each time you attach your computer to an electrical outlet. When the AC adapter is attached, the battery is charged while the computer uses AC power. Your battery's life expectancy is largely determined by the number of times it is charged, so use an AC power source to run the computer if one is available.
 - When the computer is using battery power, remove the PC Cards that you are not using.
 - When possible, attach your computer to an electrical outlet when you play CDs and DVDs. Playing a CD or DVD uses a lot of battery power.
 - Place the computer in standby mode or hibernate mode when you leave the computer unattended for long periods of time.
-

Power Conservation Modes

Standby Mode

Standby mode conserves power by turning off the display and the hard drive after a predetermined period of inactivity (a time-out). When you exit standby mode, the desktop is restored to the same state that it was in before the computer entered standby mode.

To activate standby mode:

- Click the **Start** button, click **Shut down**, click **Stand by**, and then click **OK**.

or

- Press the power button or the power conservation key combination, <Fn><Suspend>, that you programmed (via the **Advanced** tab).



HINT: You can use the **Advanced** tab to program the display-close option, the power button, and the power conservation key combination to activate standby mode.

To exit standby mode, press the power button, or if you activated standby mode by closing the display, open (raise) the display.

Hibernate Mode

Hibernate mode conserves power by copying system data to a reserved area on the hard drive and then completely turning off the computer. When you exit hibernate mode, the programs and files that were open before you activated hibernate mode are still open.

Your computer enters hibernate mode if the battery charge level becomes critically low, or if either the power button, the power conservation key combination, <Fn><Suspend>, or the display-close option are programmed to activate hibernate mode in the **Advanced** tab of the **Power Options Properties (Power Management Properties** in Microsoft® Windows® 98) window.



HINT: Some PC Cards may not operate correctly after exiting hibernate mode. If you encounter problems with a PC Card, reinsert the card or restart your computer.

To exit hibernate mode, press the power button. The computer may take a short time to exit hibernate mode. Pressing a key or touching the touch pad or track stick does not bring the computer out of hibernate mode.

Hibernate mode requires a special file on your hard drive with enough disk space to store the contents of the computer memory. Dell creates an appropriately sized hibernate mode file before shipping the computer to you. If you are using Windows 98 and you remove the file, change the amount of memory in the computer, or if your hard drive becomes corrupted, you must [recreate the file](#) before you can again use hibernate mode.

Power Options Properties

To access the Microsoft Windows **Power Options Properties (Power Management Properties** in Windows 98) window:

1. Click the **Start** button, point to **Settings**, and click **Control Panel**.
2. Double-click the **Power Options** icon (**Power Management** in Windows 98).

Power Schemes Tab

The **Power schemes** pull-down menu displays the selected preset power scheme:

- **Portable/Laptop** (default)
- **Home/Office**
- **Always On**
- **Presentation** (Windows 2000 only)
- **Minimal Power Management** (Windows 2000 only)
- **Max Battery** (Windows 2000 only)



HINT: Dell recommends that you continue to use the **Portable/Laptop** power scheme to maximize battery power conservation.

Each preset power scheme has different time-out settings for putting the computer into standby mode, turning off the display, and turning off the hard drive.

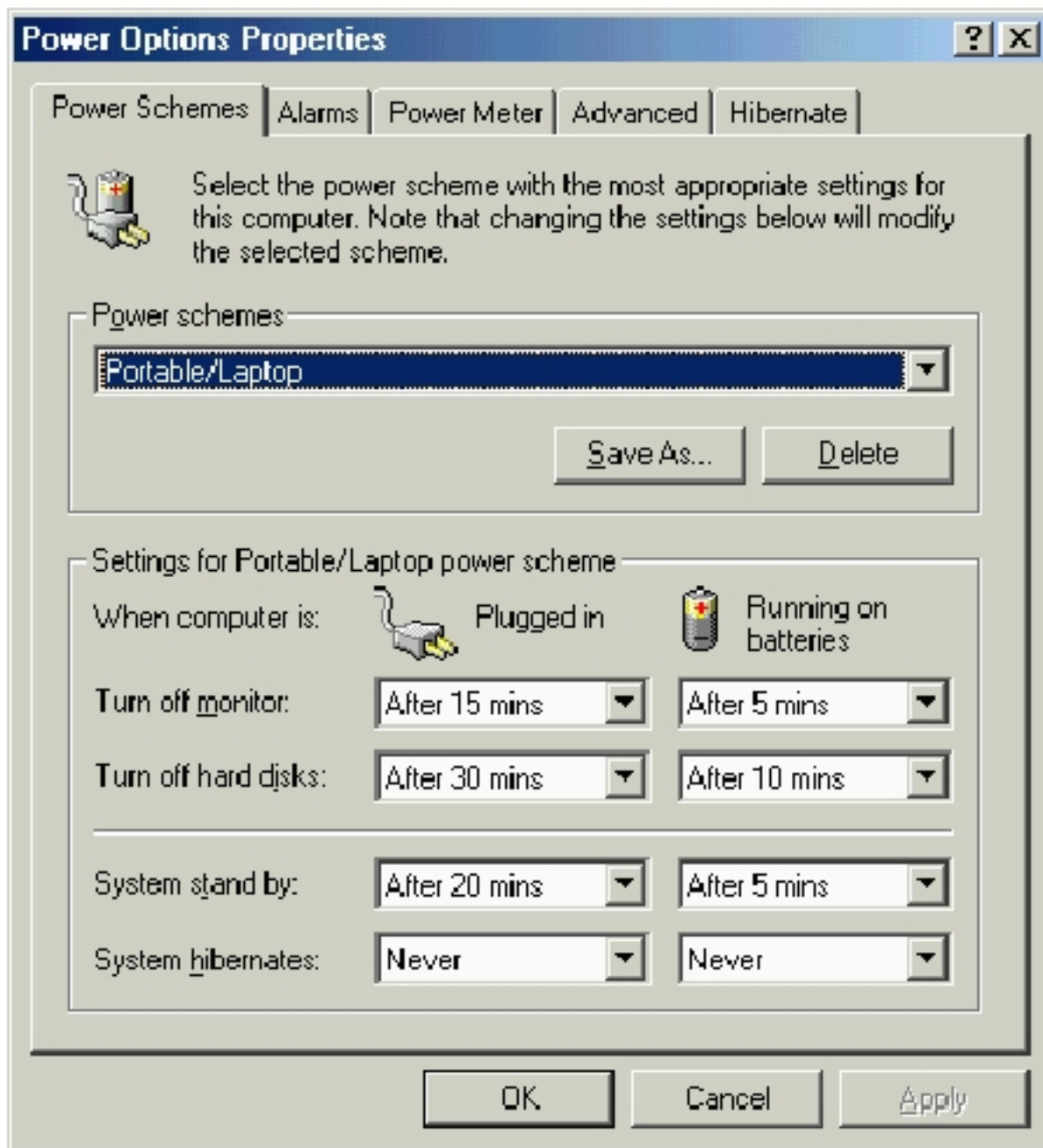

Alarms Tab



HINT: To enable audible alarms, click each **Alarm Action** button and select **Sound alarm**.

The **Low battery alarm** and **Critical battery alarm** settings alert you with a message when the battery charge falls below a certain percentage. When you receive your computer, the **Lower battery alarm** and **Critical battery alarm** check boxes are selected. Dell recommends that you continue to use these defaults.

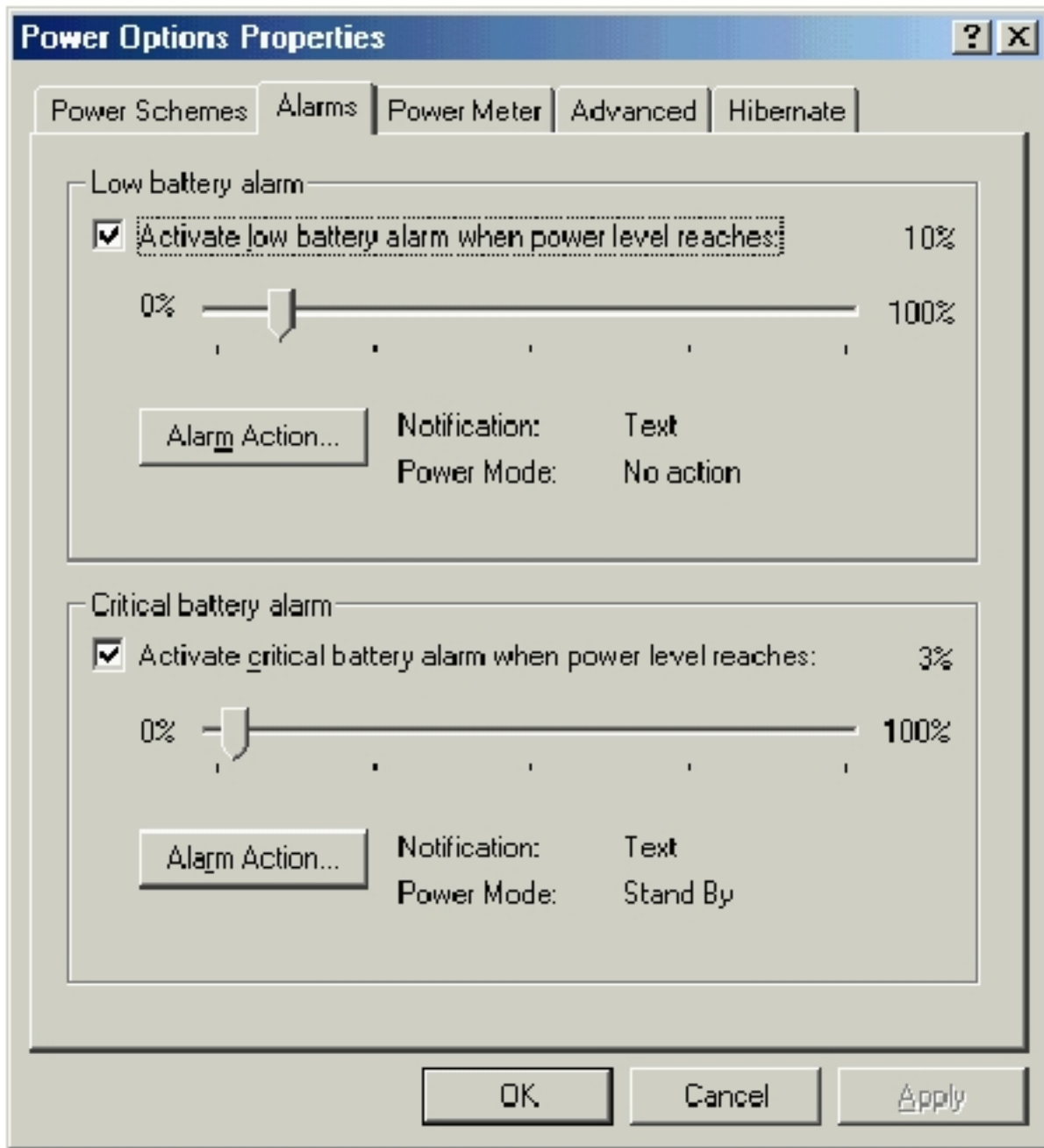

Power Meter Tab

The **Power Meter** tab displays the current power source and amount of battery charge remaining.

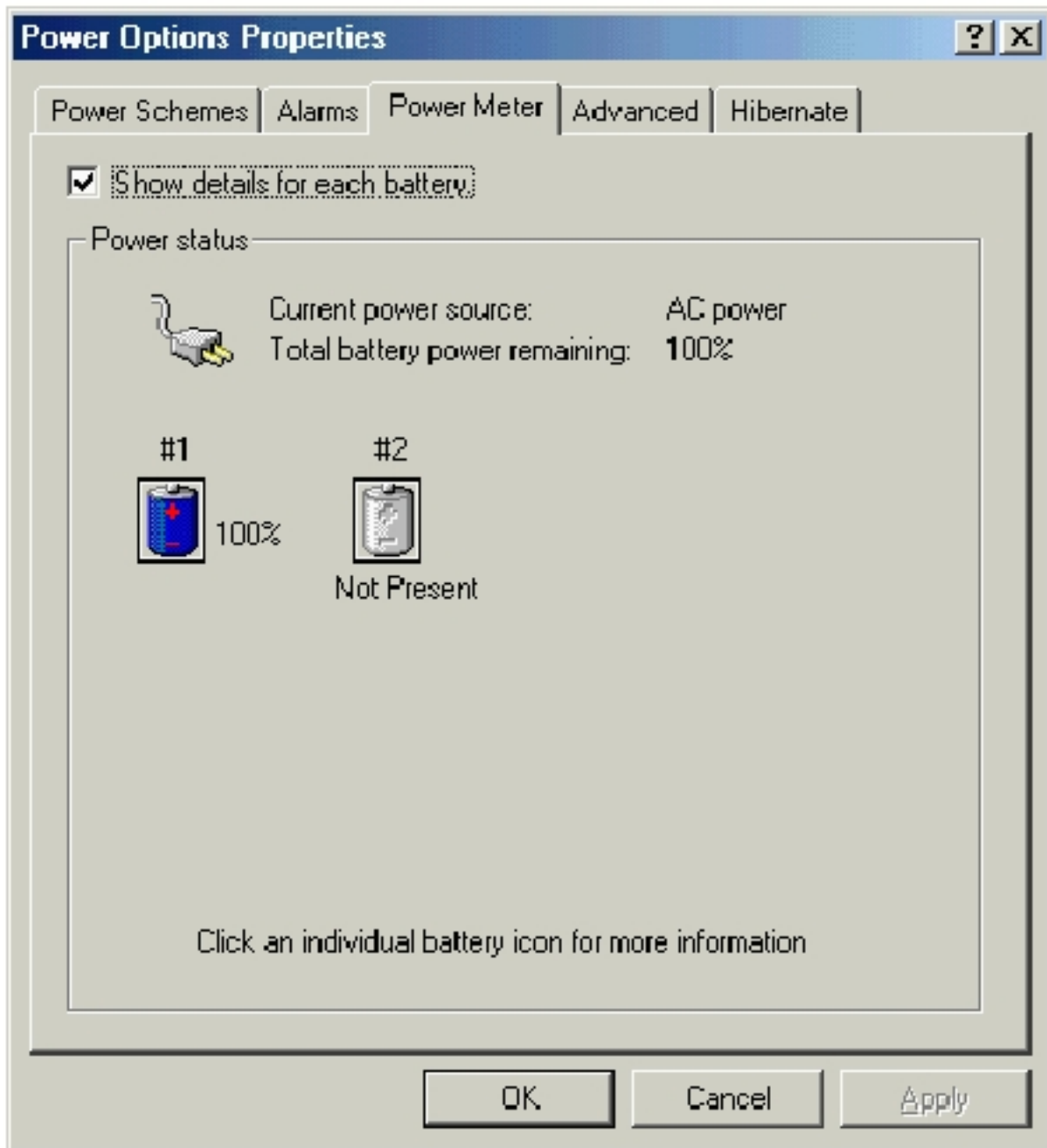

Advanced Tab

The **Advanced** tab allows you to:

- Set icon and standby password options.
- Program the following functions:
 - Activate standby mode.
 - Activate hibernate mode.
 - Shut down Windows and turn off the computer.

- o No action (**None**).

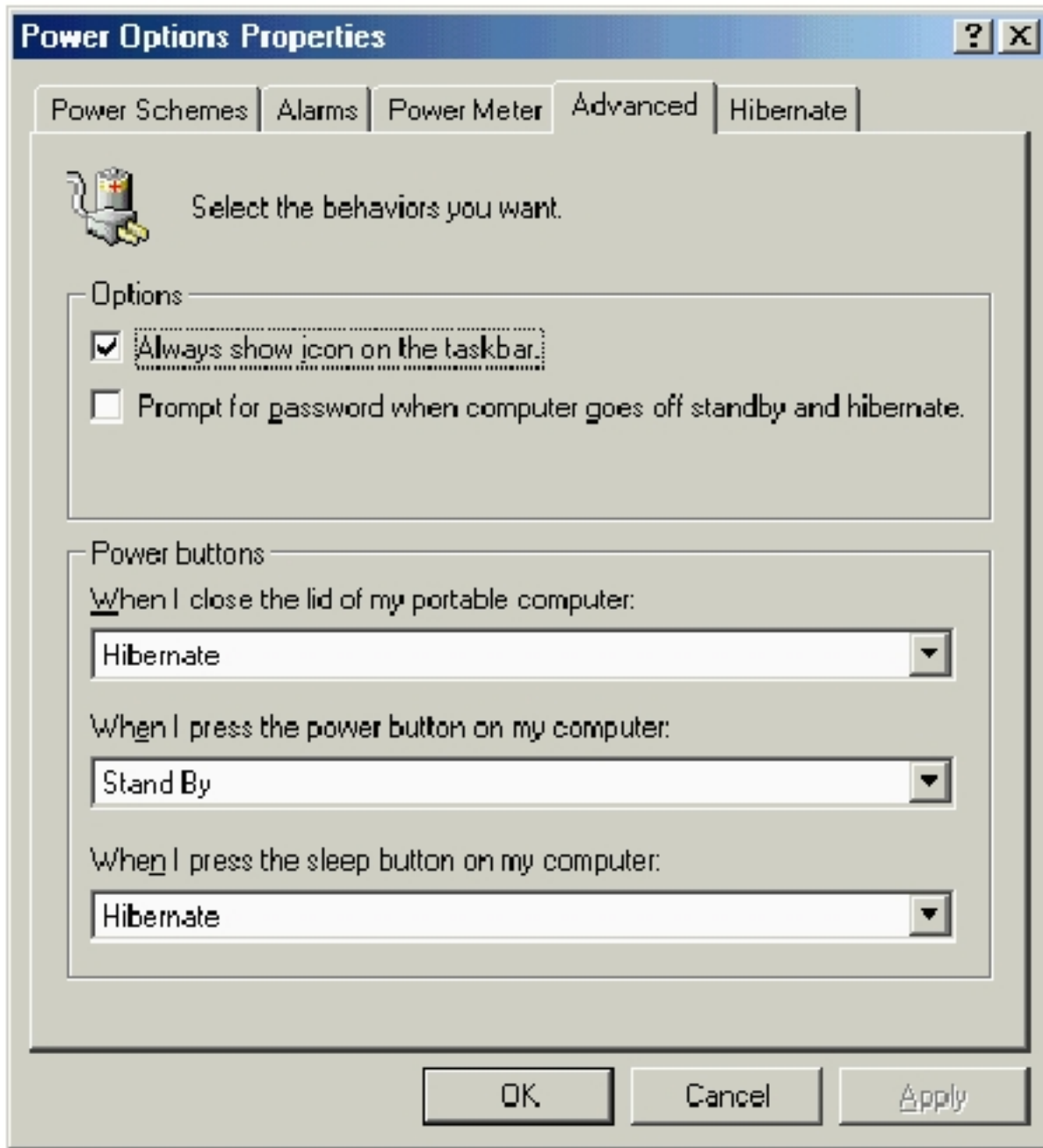

HINT: If you are going to connect your computer to a port replicator, click **None** when you program the display-close option. This setting ensures that your computer does not enter standby mode or hibernate mode when you close (lower) the display.

To program these functions, click an option from the corresponding pull-down menu, and then click **OK**.

Hibernate Tab

The **Hibernate** tab lets you enable hibernate mode by clicking the **Enable hibernate support** check

box.

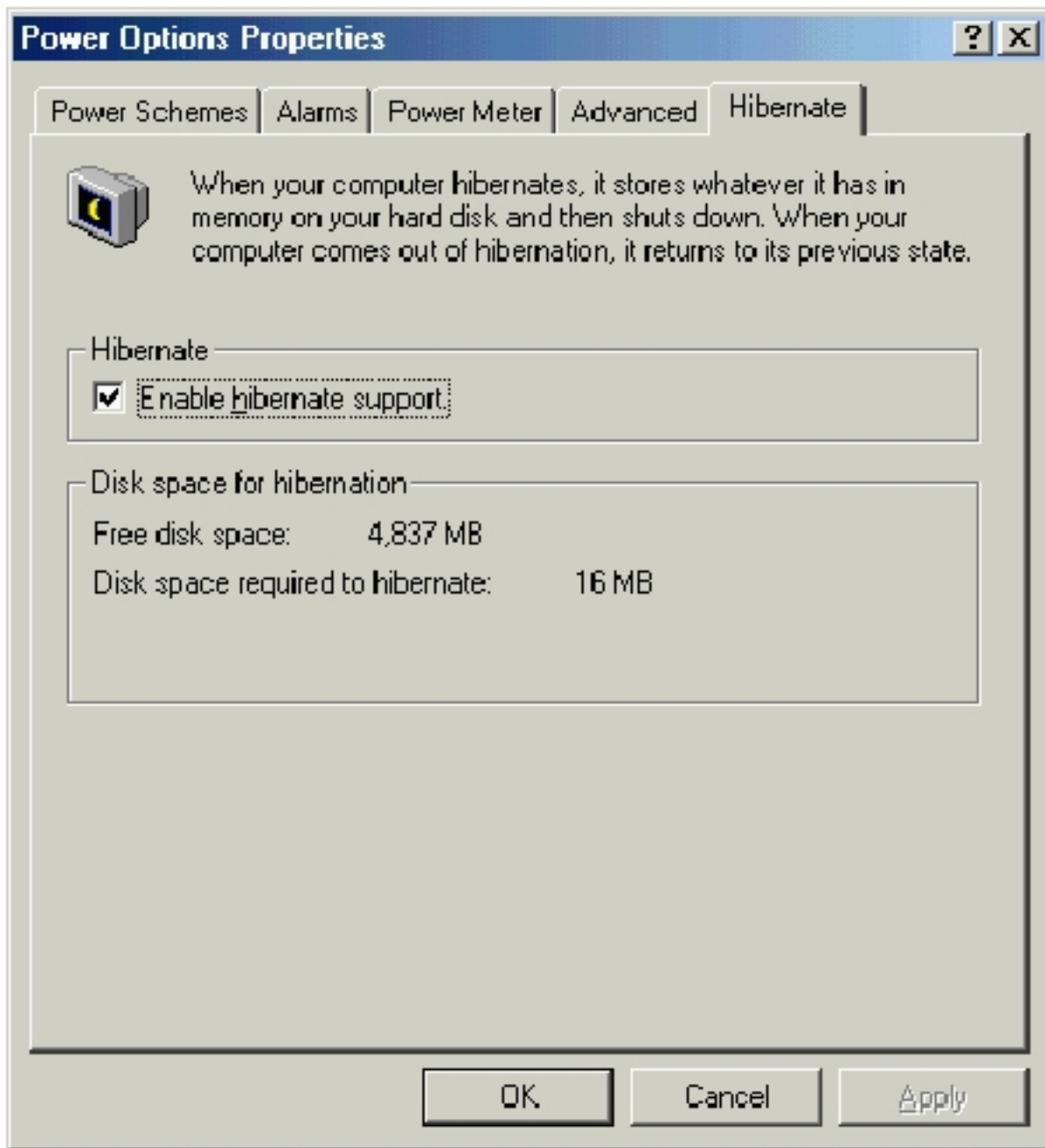

Intel® SpeedStep™ Tab

If your computer has a Mobile Intel Pentium® III processor, the **Power Options Properties (Power Management Properties** in Windows 98) window includes the **Intel® SpeedStep™** tab.

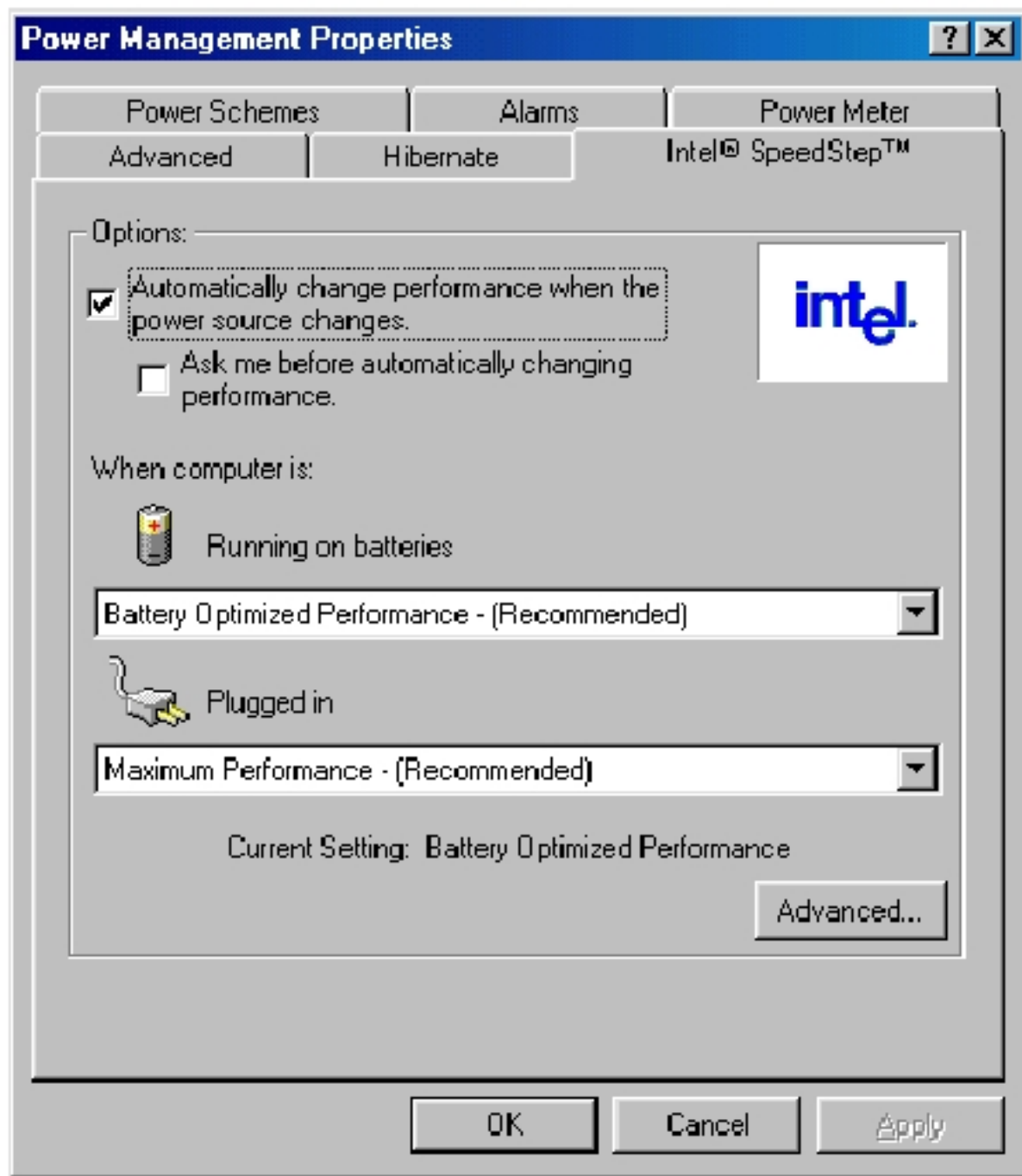

To change the Intel SpeedStep options, click the **Advanced** button and then click one of the following options.



HINT: If you disable Intel SpeedStep, the processor operates at its minimum speed.

- Disable Intel SpeedStep technology control.
- Remove flag icon.
- Disable audio notification when performance changes.

Click **Apply** to accept any changes, and then click **OK** to close the **Intel SpeedStep technology** window.

[Back to Contents Page](#)

[Back to Contents Page](#)

System Specifications

Dell™ Inspiron™ 4000[Specifications](#)

Specifications

Microprocessor	
Microprocessor types	Intel® Mobile Pentium® III Intel Mobile Celeron™
Internal cache	256 KB (Intel Mobile Pentium III) 128 KB (Intel Mobile Celeron)
External bus frequency	100 MHz
Math coprocessor	internal to the microprocessor

System Information	
System chip set	Intel Mobile 440BX PCI
Data bus width	64 bits
DRAM bus width	64 bits
Microprocessor address bus width	32 bits

PC Card	
CardBus controller	Texas Instruments PCI 1420 CardBus controller
PC Card connectors	two (supports two Type I or Type II cards or one Type III card)

Cards supported	3.3 V and 5 V
PC Card connector size	68 pins
Data width (maximum)	PCMCIA 16 bits CardBus 32 bits

Memory

Architecture	SDRAM
Memory module socket	two user-accessible SODIMM sockets
Memory module capacities	64, 128, and 256 MB
Memory type	3.3-V SODIMM
Standard memory	one 64-MB memory module
Maximum memory	512 MB
Memory clock speed	100 MHz
Memory access time	CL2 or CL3 (<i>CL2 and CL3 indicate a CAS latency of two and three clocks, respectively.</i>)

Ports and Connectors

Serial (DTE)	9-pin connector; 16550-compatible, 16-byte buffer connector
Parallel	25-hole connector; unidirectional, bidirectional, or ECP
Video	15-hole connector
Audio	microphone connector, headphone/speakers connector
S-video TV-out	7-pin mini-DIN connector (an S-video to composite video adapter included with the computer)
PS/2 keyboard/mouse	6-pin mini-DIN connector
USB	one 4-pin USB-compliant connector

Infrared	sensor compatible with IrDA Standard 1.1 (Fast IR) and IrDA Standard 1.0 (Slow IR)
Docking	200 pins for the advanced port replicator
Mini PCI	Type IIIA Mini PCI card slot
Modem	optional factory-configurable RJ11 port for Mini PCI modem
Modem/ethernet LAN	optional factory-configurable RJ11/RJ45 port for Mini PCI modem/NIC

Video

Video type	128-bit hardware accelerated
Data bus	2X AGP
Video controller	ATI RAGE Mobility 128
Video memory	8 MB
LCD interface	LVDS
TV support	NTSC or PAL in S-video and composite modes

Audio

Audio type	Sound Blaster (software emulation capable)
Audio controller	ESS Technology Maestro-3i
Stereo conversion	16-bit (analog-to-digital and digital-to-analog)
FM music synthesizer	20 voice, 72 operator
Interfaces:	
Internal	ESS1920 AC97 CODEC
External	microphone-in connector, headphone/speakers connector
Speakers	two 8-ohm speakers

Internal speaker amplifier	1.0-W channel into 4 ohms
Volume controls	key combinations, volume buttons, program menus

Display	
Type	XGA, active-matrix color (TFT)
Dimensions:	
Height	214.3 mm (8.4 inches)
Width	285.7 mm (11.3 inches)
Diagonal	357.1 mm (14.1 inches)
Maximum resolution	1024 x 768
Response time (typical)	20-ms rise (maximum), 50-ms fall (maximum)
Operating angle	0° (closed) to 180°
Viewing angle:	
Horizontal	± 45°
Vertical	+ 15°, - 30°
Dot pitch	0.28 mm
Luminance	120 nits
Power consumption:	
Panel (typical)	1.0 W
Backlight	3.4 W
Controls	brightness can be controlled through key combinations

Keyboard	
Number of keys	87 (U.S. and Canada); 88 (Europe); 90 (Japan)
Key travel	2.7 mm ± 0.3 to 0.4 mm (0.11 inch ± 0.016 inch)
Key spacing	19.05 mm ± 0.3 mm (0.75 inch ± 0.012 inch)

Layout	QWERTY/AZERTY/Kanji
--------	---------------------

Touch Pad	
Interface	PS/2 compatible
X/Y position resolution (graphics table mode)	240 cpi
Size:	
Thickness	2.00 mm (0.08 inch) at highest component
Width	64.88-mm (2.55-inch) sensor-active area
Height	48.88-mm (1.92-inch) rectangle
Weight	6.5 g (0.23 ounce)
Power:	
Supply voltage	5 V \pm 0.5 VDC
Supply current	25 mA (maximum operating for track stick and touch pad combined)
ESD	in accordance with IEC-801-2

Track Stick	
Interface	PS/2 compatible
X/Y position resolution (graphics table mode)	240 counts/sec @ 100 gf
Size	protrudes 0.5 mm higher than surrounding keycaps
Power:	
Supply voltage	5 V \pm 0.5 VDC
Supply current	25 mA (maximum operating for track stick and touch pad combined)
ESD	in accordance with IEC-801-2

Battery	
Type	4-cell or 8-cell smart lithium ion
Dimensions:	
Depth	88.5 mm (3.48 inches)
Height	21.5 mm (0.83 inch)
Width	139.0 mm (5.47 inches)
Weight	0.39 kg (0.87 lb) (8 cell) 0.22 kg (0.49 lb) (4 cell)
Voltage	14.8 VDC
Capacity	26.5 WHr (4 cell) 53 WHr (8 cell)
Charge time (approximate):	
Computer off	1 hour and 6 minutes
Life span (approximate)	500 discharge/charge cycles
Temperature range:	
Charge	0° to 35°C (32° to 95°F) (8 cell) 0° to 40°C (32° to 104°F) (4 cell)
Storage	-20° to 65°C (-4° to 140°F)

AC Adapter	
Input voltage	90 to 264 VAC
Input current (maximum)	1.7 A
Input frequency	47 to 63 Hz
Output current	4.5 A (maximum at 4-second pulse); 3.51 A (continuous)
Output power	70 W
Rated output voltage	19.5 VDC
Dimensions:	
Height	27.94 mm (1.1 inches)
Width	58.42 mm (2.3 inches)
Depth	133.35 mm (5.25 inches)

Weight (with cables)	0.4 kg (0.9 lb)
Temperature range:	
Operating	0° to 35°C (32° to 95°F)
Storage	-40° to 65°C (-40° to 140°F)

Environmental (Computer)

Temperature range:	
Operating	0° to 40°C (32° to 104°F)
Storage	-40° to 65°C (-40° to 140°F)
Relative humidity (maximum):	
Operating	10% to 90% (noncondensing)
Storage	5% to 95% (noncondensing)
Maximum vibration:	
Operating	0.9 GRMS using a random-vibration spectrum that simulates user environment
Storage	1.3 GRMS using a random-vibration spectrum that simulates air/truck shipment
Maximum shock:	
Operating	152.4 cm/sec (60 inches/sec) (equal to a half-sine pulse width of 2 ms)
Storage	203.2 cm/sec (80 inches/sec) (equal to a half-sine pulse width of 2 ms)
Altitude:	
Operating	-15.2 to 3048 m (-50 to 10,000 ft)
Storage	-15.2 to 10,668 m (-50 to 35,000 ft)

[Back to Contents Page](#)

[Back to Contents Page](#)

Solving Problems

Dell™ Inspiron™ 4000

- [Accessing Help Files](#)
- [Power Problems](#)
- [Start-Up Error Messages](#)
- [Video and Display Problems](#)
- [Sound and Speaker Problems](#)
- [Printer Problems](#)
- [Modem Problems](#)
- [Scanner Problems](#)
- [Touch Pad Problems](#)
- [External Keyboard Problems](#)
- [Unexpected Characters](#)
- [Drive Problems](#)
- [Network Problems](#)
- [Windows® Error Messages](#)
- [General Program Problems](#)
- [E-Mail Problems](#)
- [If Your Computer Gets Wet](#)
- [If You Drop or Damage Your Computer](#)
- [Resolving Other Technical Problems](#)
- [Recreating the Hibernate File \(Windows 98 Only\)](#)

Accessing Help Files



HINT: If you have a problem with an external device, see the device documentation or contact the manufacturer.

To access the *Tell Me How* help file

1. Click the **Start** button, point to **Programs—> User's Guides**, and then click **Tell Me How**.

To access *Microsoft® Windows® 2000 Help*

1. Click the **Start** button and then click **Help**.
2. Click the **Search** tab.
3. Type a word or phrase that describes your problem and then click **List Topics**.
4. Click the topic that describes your problem and then click **Display**.
5. Follow the instructions shown on the screen.

To access *Windows Me Help*

1. Click the **Start** button and then click **Help**.
2. Type a word or phrase that describes your problem in the **Search** box and then click **Go**.
3. Click the topic that describes your problem and then click **Display**.
4. Follow the instructions shown on the screen.

To access *Windows 98 SE Help*

1. Click the **Start** button and then click **Help**.
2. Type a word or phrase that describes your problem and then click **Display**.
3. In the **Topics Found** window, click the topic that describes your problem and then click **Display**.
4. Follow the instructions shown on the screen.

Power Problems



HINT: See the [Tell Me How](#) help file for information on standby mode.

Check the power light— When the power light is on, the computer has power. If the power light is blinking, the computer is in standby mode—press the power button to resume from standby mode. If the power light is off, press the power button.

Check the battery— If you are using a battery to power your computer, the battery charge may be depleted. Connect the computer to an electrical outlet using the AC adapter, and turn on the computer.

Test the electrical outlet— Ensure that the electrical outlet is working by testing it with another device, such as a lamp.

Check the AC adapter— Be sure that the power cable is firmly inserted into the electrical outlet and the green light on the AC adapter is on.

Connect the computer directly to an electrical outlet— Bypass power protection devices, power strips, and the extension cable to verify that the computer turns on.

Check for interference— Electrical appliances on the same circuit or operating near the computer can cause interference. Other causes of interference: power extension cables, too many devices on a power strip, or multiple power strips connected to the same electrical outlet.

Adjust the Power Properties— See "[Conserving Power](#)" or search for the keyword *standby* in [Windows Help](#).

Reseat the memory modules— If your computer power light turns on but the display remains blank, you may need to [reseat the memory modules](#).

Start-Up Error Messages

Operating system not found— Contact Dell. See "Contacting Dell" in the *Dell Solutions Guide* that came with your computer for the contact information.

Insert bootable media— The operating system is trying to boot to a nonbootable floppy disk or CD. Insert a bootable floppy disk or CD.

Non-system disk error— A floppy disk is in the floppy drive. Remove the floppy disk and restart the computer.

Video and Display Problems

If the display is blank

Check the power light— When the power light is on, the computer has power. If the power light is blinking, the computer is in standby mode—press the power button to exit standby mode. If the power light is off, press the power button.

Check the battery— If you are using a battery to power your computer, the battery charge may be depleted. Connect the computer to an electrical outlet using the AC adapter, and turn on the computer.

Test the electrical outlet— Ensure that the electrical outlet is working by testing it with another device, such as a lamp.

Check the AC adapter— Be sure that the power cable is firmly inserted into the electrical outlet and the green light on the AC adapter is on.

Adjust the Power Properties— See "[Conserving Power](#)" or search for the keyword *standby* in [Windows Help](#).

If the display is difficult to read

Adjust the brightness— See the [Tell Me How](#) help file for instructions on adjusting the brightness.

Move the subwoofer away from the computer or monitor— If your external speaker system includes a subwoofer, ensure that the subwoofer is at least 60 cm (2 ft) away from the computer or external monitor.

Eliminate possible interference— Turn off nearby fans, fluorescent lights, or halogen lamps to check for interference.

Rotate the computer to face a different direction— Eliminate sunlight glare, which can cause poor picture quality.

Restore the recommended settings— Restore the original resolution and refresh rate settings. For more information, see the [Tell Me How](#) help file.

Adjust the Windows display settings

1. Click the **Start** button, point to **Settings**, and then click **Control Panel**.
2. Double-click the **Display** icon and then click the **Settings** tab.
3. Try different settings for **Colors** and **Screen area**.

Sound and Speaker Problems

Integrated Speakers

Adjust the Windows volume control— Double-click the yellow speaker icon in the lower-right corner of your screen. Be sure that the volume is turned up and that the sound is not muted.

Check the volume control buttons— Press both volume control buttons simultaneously or press <Fn><End> to disable (mute) or reenable the integrated speakers.

Reinstall the Sound (audio) driver— See the utilities and drivers section for your computer's operating system ([Windows 98](#), [Windows Me](#), or [Windows 2000](#)).

External Speakers



HINT: The volume control in some MP3 players overrides the Windows volume setting. If you have been listening to MP3 songs, make sure that you did not turn the player volume down or off.

Verify the speaker cable connections— Ensure that the speakers are connected as shown on the setup diagram supplied with the speakers.

Test the electrical outlet— Ensure that the electrical outlet is working by testing it with another device, such as a lamp.

Ensure that the speakers are turned on— See the setup diagram supplied with the speakers.

Adjust the speaker controls— Adjust the volume, bass, or treble controls to eliminate distortion.

Adjust the Windows volume control— Double-click the yellow speaker icon in the lower-right corner of your screen. Be sure that the volume is turned up and that the sound is not muted.

Test the speakers— Plug the speaker audio cable into the headphone connector on the side of the computer. Ensure that the headphone volume control is turned up. Play a music CD.

Run the speaker self-test— Some speaker systems have a self-test button on the subwoofer. See the speaker documentation for self-test instructions.

Move the subwoofer away from the computer or monitor— If your external speaker system includes a subwoofer, ensure that the subwoofer is at least 60 cm (2 ft) away from the computer or external monitor.

Eliminate possible interference— Turn off nearby fans, fluorescent lights, or halogen lamps to check for interference.

Reinstall the Sound (audio) driver— See the utilities and drivers section for your computer's operating system ([Windows 98](#), [Windows Me](#), or [Windows 2000](#)).

Printer Problems

If you cannot print to a parallel port printer

Verify the printer cable connections— Ensure that the printer cable is connected (see "Connecting a Printer" in the Dell *Solutions Guide* that came with your computer).

Test the electrical outlet— Ensure that the electrical outlet is working by testing it with another device, such as a lamp.

Ensure that the printer is turned on— See the documentation supplied with the printer.

Verify that the printer is recognized by Windows—

1. Click the **Start** button, point to **Settings**, and then click **Printers**.

If the printer is listed, right-click the printer icon, click **Properties**, and then select the **Details** tab.

2. Ensure that the **Print to the following port:** setting is **LPT1 (Printer Port)**.

Reinstall the printer driver— See "Installing the Printer Driver" in the Dell *Solutions Guide* that came with your computer.

If you cannot print to a USB printer

Verify the printer cable connections— Ensure that the printer cable is connected correctly (see "Connecting a Printer" in the Dell *Solutions Guide* that came with your computer).

Test the electrical outlet— Ensure that the electrical outlet is working by testing it with another device, such as a lamp.

Ensure that the printer is turned on— See the documentation supplied with the printer.

Verify that the printer is recognized by Windows—

1. Click the **Start** button, point to **Settings**, and then click **Printers**.

If the printer is listed, right-click the printer icon, click **Properties**, and then select the **Details** tab.

2. Ensure that the **Print to the following port:** setting is **USB**.

Reinstall the printer driver— See "Installing the Printer Driver" in the Dell *Solutions Guide* that came with your computer.

Modem Problems



NOTICE: Connect the modem to an analog telephone wall jack only. Connecting the modem to a digital telephone network damages the modem.

Check the telephone jack— Disconnect the telephone line from the modem and connect it to a telephone. Listen for a dial tone.

Connect the modem directly to the telephone wall jack— If you have other telephone devices sharing the line, such as an answering machine, fax machine, surge protector, or line splitter, then bypass them and connect the modem directly to the telephone wall jack with the telephone line.

Check the connection— Verify that the telephone line is connected to the modem.

Check the telephone line— Try using a different telephone line. If you are using a line that is 3 m (10 ft) or more in length, try a shorter one.

Run the modem diagnostics— Click the **Start** button, point to **Programs**—> **3Com NIC Utilities**, and then click **3Com NIC Doctor**.

Scanner Problems

Check the power cable connection— Ensure that the scanner power cable is firmly connected to a working electrical power source and that the scanner is turned on.

Check the scanner cable connection— Ensure that the scanner cable is firmly connected to the computer and to the scanner.

Unlock the scanner— Ensure that your scanner is unlocked if it has a locking tab or button.

Reinstall the scanner driver— See the scanner documentation for instructions.

Touch Pad Problems

Check the touch pad settings— Click the **Start** button, point to **Settings**, click **Control Panel**, and then double-click the **Mouse** icon. Try adjusting the settings.

External Keyboard Problems

 **HINT:** If you connect an external PS/2 keyboard or keypad to the computer, the numeric keypad on the integrated keyboard is disabled. If you connect an external USB keyboard or keypad to the computer, the numeric keypad remains enabled.

Disconnect the keyboard cable— Shut down the computer. Disconnect the keyboard cable and check the cable connector for bent or broken pins.

Unexpected Characters

Disable the numeric keypad— Press the <Num Lk> key to disable the numeric keypad. Verify that the numbers lock light is not lit.

Drive Problems

If you cannot save a file to a floppy disk

 **HINT:** For information on saving files to a floppy disk, see the [Tell Me How](#) help file.

Ensure that Windows recognizes the drive— Double-click the **My Computer** icon. If the floppy drive is not listed, perform a full scan with your antivirus software to check for and remove viruses. Viruses can sometimes prevent Windows from recognizing the drive.

Cannot save files to a floppy disk— Ensure that the floppy disk is not full or write-protected (locked). See the following figure.

Test the drive with another floppy disk— Insert another floppy disk to eliminate the possibility that the original floppy disk is defective.

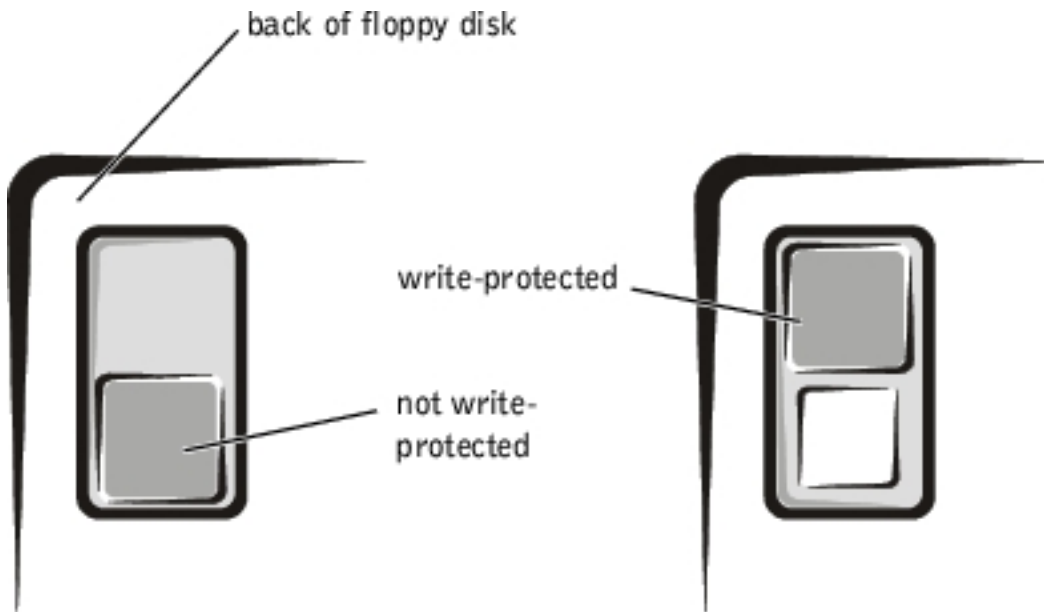

If you cannot play a music CD or install a program from a CD



HINT: High-speed CD drive vibration is normal and may cause noise. This noise does not indicate a defect in the drive or the CD.

Ensure that Windows recognizes the drive— Double-click the **My Computer** icon. If the CD drive is not listed, perform a full scan with your antivirus software to check for and remove viruses. Viruses can sometimes prevent Windows from recognizing the drive.

Test the drive with another CD— Insert another CD to eliminate the possibility that the original CD is defective.

Clean the disc— See the [Tell Me How](#) help file for instructions.

Adjust the Windows volume control— Double-click the yellow speaker icon in the lower-right corner of your screen. Be sure that the volume is turned up and that the sound is not muted.

If you cannot play a DVD movie



HINT: Because of different worldwide file types, not all DVD titles work in all DVD drives.

Ensure that Windows recognizes the drive— Double-click the **My Computer** icon. If the DVD drive is not listed, perform a full scan with your antivirus software to check for and remove viruses. Viruses can sometimes prevent Windows from recognizing the drive.

Test the drive with another DVD— Insert another DVD to eliminate the possibility that the original DVD is defective.

Clean the disc— See the [Tell Me How](#) help file for instructions.

If the CD-RW drive stops writing



HINT: If you must disable standby mode to write to a CD-RW drive, remember to enable standby mode again when you finish writing the CD.

Disable standby mode in Windows before writing to a CD-RW disk—

Search for the keyword *standby* in [Windows Help](#).

Change the write speed to a slower rate— The CD-RW drive must receive a steady stream of data when writing. If the stream is interrupted, an error occurs. Closing all programs before writing to the CD-RW may also alleviate the problem.

If you have a hard drive problem

Check the hard drive for errors

Windows 98 SE and Windows Me:

Click the **Start** button, point to **Programs—> Accessories—> System Tools**, and then click **ScanDisk**.

Windows 2000:

1. Double-click the **My Computer** icon.
2. Right-click the **Local Disk** icon and then click **Properties**.
3. Click the **Tools** tab.
4. Click **Check Now**.

Network Problems

Check the network cable connector— Ensure that the network cable connector is firmly connected to the connector on the computer and the network wall jack.

Check the network lights on the network connector— Green indicates that the network connection is active. If the status light is not green, try replacing the network cable. Amber indicates that the network card driver is loaded and the card is detecting activity.

Restart the computer— Try to log on to the network again.

Contact your network administrator— Verify that your network settings are correct and that the network is functioning.

Windows® Error Messages

x:\ is not accessible. The device is not ready— Insert a disk into the drive and try again.

A filename cannot contain any of the following characters: \ / : * ? " < > |— Do not use these characters in filenames.

Not enough memory or resources. Close some programs and try again— You have too many programs open. Close all windows and open the program that you want to use.

The file being copied is too large for the destination drive— The file that you are trying to copy is too large to fit on the disk, or the disk is too full. Try copying the file to a different disk or use a larger capacity disk.

A required .DLL file was not found— The program that you are trying to open is missing an essential file. To remove and then reinstall the program:

Windows 98 SE and Windows Me:

1. Click the **Start** button, point to **Settings**, and then click **Control Panel**.
2. Double-click the **Add/Remove Programs** icon.
3. Select the program that you want to remove.
4. Click **Add/Remove** and follow the prompts on the screen.
5. See the program documentation for installation instructions.

Windows 2000:

1. Click the **Start** button, point to **Settings**, and then click **Control Panel**.

2. Double-click the **Add/Remove Programs** icon.
3. Select the program that you want to remove.
4. Click **Change/Remove** and follow the prompts on the screen.
5. See the program documentation for installation instructions.

General Program Problems

A program crashes

See the software documentation— Many software manufacturers maintain websites with information that may help you to solve the problem.

A program stops responding

Press <Ctrl><Alt>— In the **Close Program** window, select the program that is no longer responding. Then click **End Task**.

A solid blue screen appears

Turn the computer off— If the computer does not respond to a keystroke or a proper shutdown, press the power button until the computer turns off. Press the power button again to restart the computer. The solid blue screen appears because you were not able to perform a proper Windows shutdown. ScanDisk will automatically run during the start-up process. Follow the instructions on the screen.

E-Mail Problems

Ensure that you are connected to the Internet— With the Outlook Express e-mail program open, click **File**. If **Work Offline** has a check next to it, click the check to remove it and connect to the Internet.

If Your Computer Gets Wet



CAUTION: Perform this procedure only after you are certain that it is safe to do so. If the computer is connected to an electrical outlet, Dell recommends that you turn off AC power at the circuit breaker before attempting to remove the power cables from the electrical outlet. Use the utmost caution when removing wet cables from a live power source.

1. Turn off the computer, disconnect the AC adapter from the computer, and disconnect the AC adapter from the electrical outlet.
2. Turn off any attached external devices, and disconnect them from their power sources and then from the computer.
3. Ground yourself by touching one of the metal connectors on the back of the computer.
4. Remove the modular bay device and any installed PC Cards, and put them in a safe place to dry.
5. Remove the battery.
6. Wipe off the battery and put it in a safe place to dry.
7. Remove the [hard drive](#).
8. Remove the [memory modules](#).
9. Open the display, and place the computer right-side up across two books or similar props to let air circulate all around it. Let the computer dry for at least 24 hours in a dry area at room temperature.



NOTICE: Do not use artificial means, such as a hair dryer or a fan, to speed up the drying process.



CAUTION: To help prevent electrical shock, verify that the computer is thoroughly dry before continuing with the remainder of this procedure.

10. Ground yourself by touching one of the metal connectors on the back of the computer.
11. Replace the [memory modules](#), the memory module cover, and screw.
12. Replace the [hard drive and screw](#).
13. Replace the modular bay device and any PC Cards you removed.
14. Replace the battery.
15. Turn on the computer and verify that it is working properly.

If the computer does not turn on, or if you cannot identify the damaged components, contact Dell. See "Contacting Dell" in the Dell *Solutions Guide* that came with your computer for contact information.

If You Drop or Damage Your Computer

1. Save and close any open files, exit any open programs, and shut down the computer.
2. Disconnect the AC adapter from the computer, and disconnect the AC adapter from the electrical outlet.
3. Turn off any attached external devices, and disconnect them from their power sources and then from the computer.
4. Remove and reinstall the battery.
5. Turn on the computer.

If the computer does not turn on, or if you cannot identify the damaged components, contact Dell. See "Contacting Dell" in the Dell *Solutions Guide* that came with your computer for contact information.

Resolving Other Technical Problems

Go to the Dell support website— Go to <http://support.dell.com> for help with general usage, installation, and troubleshooting questions.

E-mail Dell— Go to <http://support.dell.com> and then click **E-Mail Dell** in the **Communicate** list. Send an e-mail message to Dell about your problem; you can expect to receive an e-mail message from Dell within hours.

Call Dell— If you cannot solve your problem using the Dell support website or e-mail service, contact Dell for technical assistance. See "Contacting Dell" in the Dell *Solutions Guide* that came with your computer for contact information.

Recreating the Hibernate File (Windows 98 Only)



HINT: Windows Me and Windows 2000 recreate the hibernate file automatically.

When hibernate mode is activated, all system data is stored in the hibernate file on your hard drive. The hibernate file cannot be accessed by the Windows operating system or application programs.



HINT: If you install additional memory, you must delete the original hibernate file before recreating a new one.

You must recreate the hibernate file if you perform any of the following actions:

- Delete the hibernate file.
- Install a new hard drive.
- Reformat your hard drive.
- Install additional memory.

Boot (Restart) Your Computer With the Drivers and Utilities CD

1. Save and close any open files, exit any open programs, and shut down the computer.
2. If the computer is connected (docked) to an advanced port replicator (APR), undock it.
3. Turn on the computer.
4. Press <F2> as soon as you see the Dell logo.

System setup program Page 1 appears after a few seconds.

5. Press <Alt><p> to view Page 2.
6. Press the arrow keys to select the following boot sequence:
 - **Boot First Device: CD/DVD/CD-RW Drive**
 - **Boot Second Device: Diskette Drive**
 - **Boot Third Device: Internal HDD**
7. Press <Esc> to save your changes and exit the system setup program.
8. Restart the computer.
9. After the computer restarts and loads the diagnostic utility, press the down-arrow key to select **Exit to MS-DOS** and then press <Enter>.

Delete the Old Hibernate File

1. [Boot your computer from the *Drivers and Utilities* CD.](#)
2. At the R:\DIAGS prompt, type cd\ and press <Enter>.
3. At the R:\ prompt, type cd\win98\suspend and press <Enter>.

4. Type `rms2d` and press <Enter>.
5. Create the hibernate file.

Create the Hibernate File

1. [Boot your computer from the *Drivers and Utilities* CD](#).
2. At the `R:\DIAGS` prompt, type `cd\` and then press <Enter>.
3. At the `R:\` prompt, type `cd\win98\suspend` and press <Enter>.
4. Type `mks2d` and press <Enter>.
5. Press the power button until the computer turns off.
6. Remove the *Drivers and Utilities* CD from the CD or DVD drive.
7. Turn on the computer.

[Back to Contents Page](#)

[Back to Contents Page](#)

Drivers and Utilities for Microsoft® Windows® 98

Dell™ Inspiron™ 4000

- [Overview](#)
- [Installing Video Drivers](#)
- [Installing Audio Drivers](#)
- [Installing Dell™ AccessDirect™ Drivers](#)
- [Installing Dell DualPoint Integrated Pointing Device Drivers](#)
- [Installing Softex BayManager](#)
- [Enabling Microsoft Infrared Support](#)
- [Installing Docking Drivers](#)
- [Installing the Intel® SpeedStep™ Utility](#)
- [Reinstalling Windows 98](#)

Overview

Dell provides software utilities and drivers that help you control certain features of your computer. The utilities and drivers for Dell-installed devices are installed and operative when you receive the computer. If you ever need to reinstall any of these drivers, you can use the Dell *Drivers and Utilities* CD that came with your computer.

Often, device problems can be corrected by reinstalling the appropriate drivers. Also, hardware manufacturers frequently provide updated drivers that support feature enhancements or that correct problems. Obtain updated drivers for products purchased from Dell at the Dell support website, <http://support.dell.com>.



NOTICE: Drivers available on the Dell support site have been validated for correct operation on Dell™ computers. Installing drivers obtained from other sources may cause errors or performance degradation.

To install drivers and utilities, you need the following items:

- Dell *Drivers and Utilities* CD
- CD drive or DVD drive installed in the modular bay

 **HINT:** Your *Drivers and Utilities* CD contains drivers for operating systems that may not be on your computer. Verify that the driver you are loading is under your operating system subdirectory.

Dell recommends that you print these procedures before you begin.

 **HINT:** For more information on using the operating system installed on your computer by Dell, see the operating system documentation that came with your computer. You can also access system tools and documentation from <http://support.dell.com> by entering your service tag or Express Service Code and then clicking **Go!**.

To install the drivers and utilities correctly, you must install them in the order presented in this document.

 **NOTICE:** Make sure that the computer is undocked before you reinstall drivers.

Installing Video Drivers

 **HINT:** If you need to use extended video modes, check the documentation that came with the application program to determine if the drivers are provided. If not, contact the software manufacturer to get the necessary drivers.

Video drivers control features such as screen resolution and the number of screen colors.

1. Save and close any open files, and exit any open programs because you will need to restart your computer at the end of this procedure to complete the installation.
2. Insert the *Drivers and Utilities* CD into the drive.
3. Click the **Start** button, and then click **Run**.
4. Type `x:\win9x\video\setup`, where *x* is the drive letter of your CD drive or DVD drive, and click **OK**.
5. Follow the instructions on your display.
6. After the files are copied to your hard drive, click **Finish** to restart your computer.

After installing the video drivers and restarting your computer, perform the following steps to set the display parameters:

1. Click the **Start** button, point to **Settings**, and then click **Control Panel**.
2. Double click the **Display** icon.

3. Click the **Settings** tab.
 4. Change the **Colors** option to **True Color (24 bit)**.
 5. Set the **Screen** area of your display to **1024 x 768**.
 6. Click **Apply**.
-

Installing Audio Drivers

The audio driver allows you to customize the sound features of your computer.

1. Save and close any open files, and exit any open programs because you will need to restart your computer at the end of this procedure to complete the installation.
 2. Insert the *Drivers and Utilities* CD into the drive.
 3. Click the **Start** button, and then click **Run**.
 4. Type `x:\win9x\audio\setup`, where `x` is the drive letter of your CD drive or DVD drive, and click **OK**.
 5. Follow the instructions on your display.
 6. After the files are copied to your hard drive, click **Finish** to restart your computer.
-

Installing Dell™ AccessDirect™ Drivers

Dell AccessDirect drivers allow you to use and customize the AccessDirect button.

1. Save and close any open files, and exit any open programs because you will need to restart your computer at the end of this procedure to complete the installation.
 2. Insert the *Drivers and Utilities* CD into the drive.
 3. Click the **Start** button, and then click **Run**.
 4. Type `x:\win9x\accessd\setup`, where `x` is the drive letter of your CD drive or DVD drive, and click **OK**.
 5. Follow the instructions on your display.
 6. After the files are copied to your hard drive, click **Finish** to restart your computer.
-

Installing Dell DualPoint Integrated Pointing Device Drivers

Dell DualPoint integrated pointing device drivers and associated utilities allow you to use and customize the integrated touch pad, track stick, and external mouse.

1. Save and close any open files, and exit any open programs because you will need to restart your computer at the end of this procedure to complete the installation.
 2. Insert the *Drivers and Utilities* CD into the drive.
 3. Click the **Start** button, and then click **Run**.
 4. Type `x:\win9x\touchpad\language\setup`, where *x* is the drive letter of your CD drive or DVD drive and *language* is English, Brazport (Brazilian Portuguese), French, German, Italian, Japanese, Korean, Schinese (Simplified Chinese), Spanish, or Tchinese (Traditional Chinese). Click **OK**.
 5. Follow the instructions on your display.
 6. After the files are copied to your hard drive, click **Finish** to restart your computer.
-

Installing Softex BayManager

The Softex BayManager software allows you to swap modular bay devices without shutting down and rebooting your computer.

1. Save and close any open files, and exit any open programs because you will need to restart your computer at the end of this procedure to complete the installation.
 2. Insert the *Drivers and Utilities* CD into the drive.
 3. Click the **Start** button, and then click **Run**.
 4. Type `x:\win9x\baymgr\setup`, where *x* is the drive letter of your CD drive or DVD drive, and click **OK**.
 5. Follow the instructions on your display.
 6. After the files are copied to your hard drive, click **Finish** to restart your computer.
-

Enabling Microsoft Infrared Support

You must enable Microsoft infrared support before you can use it.

1. Enter the [system setup program](#) and set the **Infrared Data Port** option to **COM1**, **COM2**, **COM3** (recommended), or **COM4**. The default for **Infrared Data Port** is **Disabled**.
2. Set the **Infrared Mode** option to either **Fast IR** or **Slow IR**.
3. Restart the computer.
4. Click the **Start** button, point to **Settings**, and then click **Control Panel**.
5. Double-click the **Add New Hardware** icon.



HINT: If the infrared device is not listed, click **No** and then click **Next**.

6. In the **Add New Hardware** window, click **Next** to continue.
7. When the **Add New Hardware Wizard** asks to search for new hardware, click **No** and then click **Next**.
8. When the **Hardware Types** window appears, click the **Infrared** tab and then click **Next**.
9. When the **Add Infrared Device Wizard** window appears, click **Next**.
10. Follow the instructions on your display.
11. After completing the instructions, restart you computer.

Installing Docking Drivers

To reinstall the docking drivers for your computer, you must run the Dock QuickInstall program before you install the docking drivers.

Running Dock QuickInstall

1. If the computer has never been turned on, turn it on while it is undocked and complete the operating system setup.

For setup instructions, see the operating system documentation that came with the computer.

2. Save and close any open files, and exit any open programs because you will need to restart your computer at the end of this procedure to complete the installation.

3. Insert the *Drivers and Utilities* CD into the drive.
4. Click the **Start** button, and then click **Run**.
5. Type `x:\win9x\dockqi\setup`, where *x* is the drive letter of your CD drive or DVD drive, and click **OK**.
6. Follow the instructions on your display.
7. After the files are copied to your hard drive, click **Finish** to restart your computer.

Installing Docking Drivers

1. If you have completed the operating system setup, turn on the computer.
2. Dock the computer.

For instructions on using the advanced port replicator (APR), see the *Advanced Port Replicator User's Guide* that came with the computer. The operating system creates a hardware profile for the APR.

3. To load the appropriate drivers for use with the APR, follow the instructions on the display.
4. When prompted, restart the computer.

Installing the Intel® SpeedStep™ Utility

The Intel SpeedStep utility conserves battery power by automatically adjusting the processor speed when you run your computer from the battery instead of AC power. Intel SpeedStep technology reduces the processor speed when the computer is running on the battery and resumes maximum processor speed when the computer is plugged into an electrical outlet.

1. Save and close any open files, and exit any open programs because you will need to restart your computer at the end of this procedure to complete the installation.
2. Insert the *Drivers and Utilities* CD into the drive.
3. Click the **Start** button, and then click **Run**.
4. Type `x:\win9x\speedstp\language\setup`, where *x* is the drive letter of your CD drive or DVD drive and *language* is English, French, German, Italian, Japanese, Korean, Schinese (Simplified Chinese), Spanish, or Tchinese (Traditional Chinese). Click **OK**.
5. Follow the instructions on your display.
6. After the files are copied to your hard drive, click **Finish** to restart your computer.

Reinstalling Windows 98

 **NOTICE:** The *Operating System* CD provides options for reinstalling your Windows 98 Second Edition (SE) operating system. The options can potentially overwrite files installed by Dell and possibly affect programs installed on your hard drive. Therefore, Dell does not recommend that you reinstall your operating system unless instructed to do so by a Dell technical support representative.

 **NOTICE:** To prevent conflicts with Windows 98, you must disable any virus protection software installed on your system before you reinstall Windows.

1. Turn on the computer, and enter the system setup program as directed by a Dell technical support representative.
2. In the system setup program **Boot** menu, change the boot sequence so that the CD or DVD drive boots first as directed by a Dell technical support representative. Then place the *Operating System* CD in the CD or DVD drive and close the drive tray.
3. Exit the system setup program.
4. At the **Welcome** window, click **OK**.
5. Double-click **Refresh Windows OS**.
6. Click **OK**.
7. Click **OK** again.
8. Remove the *Operating System* CD from the CD or DVD drive, and click **OK** to restart your computer.

The **Getting ready to run Windows for the first time** window appears.

9. If the mouse tutorial starts, press <Esc> to exit and then press <y>.
10. Click the regional setting closest to where you live, and then click **Next**.
11. Click the graphic that matches your keyboard layout, and then click **Next**.
12. In the **User Information** window, type your name and, if applicable, company name, and then click **Next**.

The **Name** field must be completed; the **Company Name** field is optional.

The **License Agreement** window appears.

13. Click **I accept the Agreement**, and then click **Next**.

14. Type the Windows Product Key in the fields provided, and then click **Next**.

The Product Key is the bar code number found on the Microsoft Windows label, which is located on the computer.

15. When the **Start Wizard** appears, click **Finish**.

The **Enter Windows Password** window appears. To continue without creating a Windows user name and password, click **OK**. Otherwise, type your user name and password in the appropriate fields, and then click **OK**.

16. If the **Date/Time Properties** window appears, adjust the date and time properties, click **Apply**, and then click **OK**.

Windows updates the system settings and restarts your computer.

17. If you created a Windows user name and password, type your password and click **OK**.
18. Reinstall the appropriate drivers.
19. Reenable your virus protection software.

[Back to Contents Page](#)

[Back to Contents Page](#)

Drivers and Utilities for Microsoft® Windows® Millennium Edition (Me)

Dell™ Inspiron™ 4000

- [Overview](#)
- [Installing Video Drivers](#)
- [Installing Audio Drivers](#)
- [Installing Dell™ AccessDirect™ Drivers](#)
- [Installing Dell DualPoint Integrated Pointing Device Drivers](#)
- [Installing Softex BayManager](#)
- [Installing Docking Drivers](#)
- [Installing the Intel® SpeedStep™ Utility](#)
- [Reinstalling Windows Me](#)

Overview

Dell provides software utilities and drivers that help you control certain features of your computer. The utilities and drivers for Dell-installed devices are installed and operative when you receive the computer. If you ever need to reinstall any of these drivers, you can use the Dell *Drivers and Utilities* CD that came with your computer.

Often, device problems can be corrected by reinstalling the appropriate drivers. Also, hardware manufacturers frequently provide updated drivers that support feature enhancements or that correct problems. Obtain updated drivers for products purchased from Dell at the Dell support website, <http://support.dell.com>.



NOTICE: Drivers available on the Dell support site have been validated for correct operation on Dell™ computers. Installing drivers obtained from other sources may cause errors or performance degradation.

To install drivers and utilities, you need the following items:

- Dell *Drivers and Utilities* CD
- CD drive or DVD drive installed in the modular bay



HINT: Your *Drivers and Utilities* CD contains drivers for operating systems that may not be on your computer. Verify that the driver you are loading is under your operating system subdirectory.

Dell recommends that you print these procedures before you begin.



HINT: For more information on using the operating system installed on your computer by Dell, see the operating system documentation that came with your computer. You can also access system tools and documentation from <http://support.dell.com> by entering your service tag or Express Service Code and then clicking **Go!**.

To install the drivers and utilities correctly, you must install them in the order presented in this document.



NOTICE: Make sure that the computer is undocked before you reinstall drivers.

Installing Video Drivers



HINT: If you need to use extended video modes, check the documentation that came with the application program to determine if the drivers are provided. If not, contact the software manufacturer to get the necessary drivers.

Video drivers control features such as screen resolution and the number of screen colors.

1. Save and close any open files, and exit any open programs because you will need to restart your computer at the end of this procedure to complete the installation.
2. Insert the *Drivers and Utilities* CD into the drive.
3. Click the **Start** button, and then click **Run**.
4. Type `x:\winme\video\setup`, where *x* is the drive letter of your CD drive or DVD drive, and click **OK**.
5. Follow the instructions on your display.
6. After the files are copied to your hard drive, click **Finish** to restart your computer.

After installing the video drivers and restarting your computer, perform the following steps to set the display parameters:

1. Click the **Start** button, point to **Settings**, and then click **Control Panel**.
2. Double click the **Display** icon.

3. Click the **Settings** tab.
 4. Change the **Colors** option to **True Color (24 bit)**.
 5. Set the **Screen** area of your display to **1024 x 768**.
 6. Click **Apply**.
-

Installing Audio Drivers

The audio driver allows you to customize the sound features of your computer.

1. Save and close any open files, and exit any open programs because you will need to restart your computer at the end of this procedure to complete the installation.
 2. Insert the *Drivers and Utilities* CD into the drive.
 3. Click the **Start** button, and then click **Run**.
 4. Type `x:\winme\audio\setup`, where `x` is the drive letter of your CD drive or DVD drive, and click **OK**.
 5. Follow the instructions on your display.
 6. After the files are copied to your hard drive, click **Finish** to restart your computer.
-

Installing Dell™ AccessDirect™ Drivers

Dell AccessDirect drivers allow you to use and customize the AccessDirect button.

1. Save and close any open files, and exit any open programs because you will need to restart your computer at the end of this procedure to complete the installation.
 2. Insert the *Drivers and Utilities* CD into the drive.
 3. Click the **Start** button, and then click **Run**.
 4. Type `x:\winme\accessd\setup`, where `x` is the drive letter of your CD drive or DVD drive, and click **OK**.
 5. Follow the instructions on your display.
 6. After the files are copied to your hard drive, click **Finish** to restart your computer.
-

Installing Dell DualPoint Integrated Pointing Device Drivers

Dell DualPoint integrated pointing device drivers and associated utilities allow you to use and customize the integrated touch pad, track stick, and external mouse.

1. Save and close any open files, and exit any open programs because you will need to restart your computer at the end of this procedure to complete the installation.
 2. Insert the *Drivers and Utilities* CD into the drive.
 3. Click the **Start** button, and then click **Run**.
 4. Type `x:\winme\touchpad\language\setup`, where *x* is the drive letter of your CD drive or DVD drive and *language* is English, Brazport (Brazilian Portuguese), French, German, Italian, Japanese, Korean, Schinese (Simplified Chinese), Spanish, or Tchinese (Traditional Chinese). Click **OK**.
 5. Follow the instructions on your display.
 6. After the files are copied to your hard drive, click **Finish** to restart your computer.
-

Installing Softex BayManager

The Softex BayManager software allows you to swap modular bay devices without shutting down and rebooting your computer.

1. Save and close any open files, and exit any open programs because you will need to restart your computer at the end of this procedure to complete the installation.
 2. Insert the *Drivers and Utilities* CD into the drive.
 3. Click the **Start** button, and then click **Run**.
 4. Type `x:\winme\baymgr\setup`, where *x* is the drive letter of your CD drive or DVD drive, and click **OK**.
 5. Follow the instructions on your display.
 6. After the files are copied to your hard drive, click **Finish** to restart your computer.
-

Installing Docking Drivers

To reinstall the docking drivers for your computer, you must run the Dock QuickInstall program before you install the docking drivers.

Running Dock QuickInstall

1. If the computer has never been turned on, turn it on while it is undocked and complete the operating system setup.

For setup instructions, see the operating system setup guide that came with the computer.

2. Save your work in all open application programs because you will need to restart your computer at the end of this procedure to complete the installation.
3. Insert the *Drivers and Utilities* CD into the drive.
4. Click the **Start** button, and then click **Run**.
5. Type `x:\winme\dockqi\setup`, where *x* is the drive letter of your CD drive or DVD drive, and click **OK**.
6. Follow the instructions on your display.
7. After the files are copied to your hard drive, click **Finish** to restart your computer.

Installing Docking Drivers

1. If you have completed the operating system setup, turn on the computer.
2. Dock the computer.

For instructions on using the advanced port replicator (APR), see the *Advanced Port Replicator User's Guide* that came with the computer. The operating system creates a hardware profile for the APR.

3. To load the appropriate drivers for use with the APR, follow the instructions on the display.
4. When prompted, restart the computer.



Installing the Intel® SpeedStep™ Utility

The Intel SpeedStep utility conserves battery power by automatically adjusting the processor speed when you run your computer from the battery instead of AC power. Intel SpeedStep technology

reduces the processor speed when the computer is running on the battery and resumes maximum processor speed when the computer is plugged into an electrical outlet.

1. Save your work in all open application programs because you will need to restart your computer at the end of this procedure to complete the installation.
 2. Insert the *Drivers and Utilities* CD into the drive.
 3. Click the **Start** button, and then click **Run**.
 4. Type `x:\winme\speedstp\language\setup`, where *x* is the drive letter of your CD drive or DVD drive and *language* is English, French, German, Italian, Japanese, Korean, Schinese (Simplified Chinese), Spanish, or Tchinese (Traditional Chinese). Click **OK**.
 5. Follow the instructions on your display.
 6. After the files are copied to your hard drive, click **Finish** to restart your computer.
-

Reinstalling Windows Me

-  **NOTICE:** The *Operating System* CD provides options for reinstalling your Windows Me operating system. The options can potentially overwrite files installed by Dell and possibly affect programs installed on your hard drive. Therefore, Dell does not recommend that you reinstall your operating system unless instructed to do so by a Dell technical support representative.
 -  **NOTICE:** To prevent conflicts with Windows Me, you must disable any virus protection software installed on your system before you reinstall Windows.
1. Turn on the computer, and enter the system setup program as directed by a Dell technical support representative.
 2. In the system setup program **Boot** menu, change the boot sequence so that the CD or DVD drive boots first as directed by a Dell technical support representative. Then place the *Operating System* CD in the CD or DVD drive and close the drive tray.
 3. Exit the system setup program.
 4. At the **Welcome** window, click **OK**.
 5. Double-click **Refresh Windows OS**.
 6. Click **OK**.
 7. Click **OK** again.
 8. Remove the *Operating System* CD from the CD or DVD drive, and click **OK** to restart your computer.

The **Getting ready to run Windows for the first time** window appears.

9. If the mouse tutorial starts, press <Esc> to exit and then press <y>.
10. Click the regional setting closest to where you live, and then click **Next**.
11. Click the graphic that matches your keyboard layout, and then click **Next**.
12. In the **User Information** window, type your name and, if applicable, company name, and then click **Next**.

The **Name** field must be completed; the **Company Name** field is optional.

The **License Agreement** window appears.

13. Click **I accept the Agreement**, and then click **Next**.
14. Type the Windows Product Key in the fields provided, and then click **Next**.

The Product Key is the bar code number found on the Microsoft Windows label, which is located on the computer.

15. When the **Start Wizard** appears, click **Finish**.

The **Enter Windows Password** window appears. To continue without creating a Windows user name and password, click **OK**. Otherwise, type your user name and password in the appropriate fields, and then click **OK**.

16. If the **Date/Time Properties** window appears, adjust the date and time properties, click **Apply**, and then click **OK**.

Windows updates the system settings and restarts your computer.

17. If you created a Windows user name and password, type your password and click **OK**.
18. Reinstall the appropriate drivers.
19. Reenable your virus protection software.

Enabling Hibernate Support

1. Click the **Start** button, point to **Settings**, and click **Control Panel**.
2. Double-click the **Power Options** icon.
3. Click the **Hibernate** tab.
4. Click **Enable hibernate support** to check it, and click **Apply**.
5. Click **OK** to close the **Power Options Properties** window.

[Back to Contents Page](#)

[Back to Contents Page](#)

Drivers and Utilities for Microsoft® Windows® 2000

Dell™ Inspiron™ 4000

- [Overview](#)
 - [Installing Video Drivers](#)
 - [Installing Audio Drivers](#)
 - [Installing Dell™ AccessDirect™ Drivers](#)
 - [Installing Dell DualPoint Integrated Pointing Device Drivers](#)
 - [Installing the Intel® SpeedStep™ Utility](#)
 - [Reinstalling Windows 2000](#)
-

Overview

Dell provides software utilities and drivers that help you control certain features of your computer. The utilities and drivers for Dell-installed devices are installed and operative when you receive the computer. If you ever need to reinstall any of these drivers, you can use the Dell *Drivers and Utilities* CD that came with your computer.

Often, device problems can be corrected by reinstalling the appropriate drivers. Also, hardware manufacturers frequently provide updated drivers that support feature enhancements or that correct problems. Obtain updated drivers for products purchased from Dell at the Dell support website, <http://support.dell.com>.



NOTICE: Drivers available on the Dell support site have been validated for correct operation on Dell™ computers. Installing drivers obtained from other sources may cause errors or performance degradation.

To install drivers and utilities, you need the following items:

- Dell *Drivers and Utilities* CD
- CD drive or DVD drive installed in the modular bay



HINT: Your *Drivers and Utilities* CD contains drivers for operating systems that may not be on your computer. Verify that the driver you are loading is under your operating system subdirectory.

Dell recommends that you print these procedures before you begin.



HINT: For more information on using the operating system installed on your computer by Dell, see the operating system documentation that came with your computer. You can also access system tools and documentation from <http://support.dell.com> by entering your service tag or Express Service Code and then clicking **Go!**

To install the drivers and utilities correctly, you must install them in the order presented in this document.



NOTICE: Make sure that the computer is undocked before you reinstall drivers.

Installing Video Drivers



HINT: If you need to use extended video modes, check the documentation that came with the application program to determine if the drivers are provided. If not, contact the software manufacturer to get the necessary drivers.

Video drivers control features such as screen resolution and the number of screen colors.

1. Save and close any open files, and exit any open programs because you will need to restart your computer at the end of this procedure to complete the installation.
2. Insert the *Drivers and Utilities* CD into the drive.
3. Click the **Start** button, and then click **Run**.
4. Type `x:\w2k\video\setup`, where `x` is the drive letter of your CD drive or DVD drive, and click **OK**.
5. Follow the instructions on your display.
6. After the files are copied to your hard drive, click **Finish** to restart your computer.

After installing the video drivers and restarting your computer, perform the following steps to set the display parameters:

1. Click the **Start** button, point to **Settings**, and then click **Control Panel**.
2. Double click the **Display** icon.

3. Click the **Settings** tab.
 4. Change the **Colors** option to **True Color (24 bit)**.
 5. Set the **Screen** area of your display to **1024 x 768**.
 6. Click **Apply**.
-

Installing Audio Drivers

The audio driver allows you to customize the sound features of your computer.

1. Save and close any open files, and exit any open programs because you will need to restart your computer at the end of this procedure to complete the installation.
 2. Insert the *Drivers and Utilities* CD into the drive.
 3. Click the **Start** button, point to **Settings**, and then click **Control Panel**.
 4. Double-click the **Multimedia** icon.
 5. Click the **Devices** tab in the **Multimedia Properties** window.
 6. Click **Add...**
 7. Click **Unlisted or Updated Driver**, and then click **OK**.
 8. Type `x:\w2k\audio\setup`, where *x* is the drive letter of your CD drive or DVD drive. Click **OK**.
 9. Follow the instructions on your display.
 10. After the installation is completed, restart your computer to activate the drivers.
-

Installing Dell™ AccessDirect™ Drivers

Dell AccessDirect drivers allow you to use and customize the AccessDirect button.

1. Save and close any open files, and exit any open programs because you will need to restart your computer at the end of this procedure to complete the installation.
2. Insert the *Drivers and Utilities* CD into the drive.
3. Click the **Start** button, and then click **Run**.
4. Type `x:\w2k\accessd\setup`, where *x* is the drive letter of your CD drive or DVD drive, and

click **OK**.

5. Follow the instructions on your display.
 6. After the files are copied to your hard drive, click **Finish** to restart your computer.
-

Installing Dell DualPoint Integrated Pointing Device Drivers

Dell DualPoint integrated pointing device drivers and associated utilities allow you to use and customize the integrated touch pad, track stick, and external mouse.

1. Save and close any open files, and exit any open programs because you will need to restart your computer at the end of this procedure to complete the installation.
 2. Insert the *Drivers and Utilities* CD into the drive.
 3. Click the **Start** button, and then click **Run**.
 4. Type `x:\w2k\touchpad\language\setup`, where *x* is the drive letter of your CD drive or DVD drive and *language* is English, Brazport (Brazilian Portuguese), French, German, Italian, Japanese, Korean, Schinese (Simplified Chinese), Spanish, or Tchinese (Traditional Chinese). Click **OK**.
 5. Follow the instructions on your display.
 6. After the files are copied to your hard drive, click **Finish** to restart your computer.
-

Installing the Intel® SpeedStep™ Utility

The Intel SpeedStep utility conserves battery power by automatically adjusting the processor speed when you run your computer from the battery instead of AC power. Intel SpeedStep technology reduces the processor speed when the computer is running on the battery and resumes maximum processor speed when the computer is plugged into an electrical outlet.

1. Save and close any open files, and exit any open programs because you will need to restart your computer at the end of this procedure to complete the installation.
2. Insert the *Drivers and Utilities* CD into the drive.
3. Click the **Start** button, and then click **Run**.
4. Type `x:\w2k\speedstp\language\setup`, where *x* is the drive letter of your CD drive or DVD drive and *language* is English, French, German, Italian, Japanese, Korean, Schinese

(Simplified Chinese), Spanish, or Tchinese (Traditional Chinese). Click **OK**.

5. Follow the instructions on your display.
 6. After the files are copied to your hard drive, click **Finish** to restart your computer.
-

Reinstalling Windows 2000

1. Insert the *Operating System* CD into the CD or DVD drive.
2. Shut down the computer.
3. Turn on the computer.
4. Press any key when the `Press any key to boot from CD` message appears on the screen.
5. When the **Windows 2000 Setup** window appears, ensure that the **To setup Win2000 now, press ENTER** option is highlighted. Then press <Enter>.
6. Read the information in the **License Agreement** window, and then press <F8> to continue.
7. When the **Windows 2000 Professional Setup** window appears, press the arrow keys to select the Windows 2000 partition option that you want. To continue, press the key specified in the partition option that you chose.
8. When the **Windows 2000 Professional Setup** window reappears, press the arrow keys to select the type of filing system that you want Windows 2000 to use, and then press <Enter>.
9. Press <Enter> again to restart your computer.
10. Click **Next** when the **Welcome to the Windows 2000 Setup Wizard** window appears.
11. When the **Regional Settings** window appears, select the settings for your locale, and then click **Next**.
12. Enter your name and organization in the **Personalize Your Software** window, and then click **Next**.
13. When prompted, enter the Windows Product Key, which is printed on the Microsoft label on your computer. Then click **Next**.
14. When the **Computer Name and Administrator Password** window appears, enter a name for your computer and a password, if desired. Then click **Next**.
15. Enter the date and time in the **Date and Time Settings** window, and then click **Next**.

Windows 2000 begins to install its components and configure the computer.

16. When the **Completing the Windows 2000 Setup Wizard** window appears, remove the CD from the drive, and then click **Finish**. The computer automatically restarts.

Enabling Hibernate Support

1. Click the **Start** button, point to **Settings**, and click **Control Panel**.
 2. Double-click the **Power Options** icon.
 3. Click the **Hibernate** tab.
 4. Click **Enable hibernate support** to check it, and click **Apply**.
 5. Click **OK** to close the **Power Options Properties** window.
-

[Back to Contents Page](#)

[Back to Contents Page](#)

System Setup Program

Dell™ Inspiron™ 4000

- [Standard Settings](#)
 - [System Setup Program Pages](#)
 - [Viewing the System Setup Program Pages](#)
-

Standard Settings

The system setup program contains the standard settings for your computer.

-  **NOTICE:** Unless you are an expert computer user, don't change the settings for this program. Certain changes might make your computer work incorrectly.
-

System Setup Program Pages

-  **HINT:** To see information about a specific item, highlight the item and refer to the **Help** area on the screen.

The system setup program pages display the current setup information and settings for your computer. You can change settings that appear as white type on the screen.

- Page 1 displays system information.
- Page 2 displays boot configuration and dock configuration settings.
- Page 3 displays basic device configuration settings.
- Page 4 displays battery charge status.
- Page 5 displays power management settings.
- Page 6 displays system security and hard drive password settings.

For detailed information on options and settings, download the system setup program executable file and save it to your hard drive. Double-click the file to open it, and navigate through the example

screens just as you would navigate through your actual system setup program pages. The information on the right side of the screen provides details about the settings. Making changes in this file will not affect your system settings. It is merely a simulation of the system setup program pages.

*Dell Inspiron 4000 System
Setup Program*

Download

(48 KB)

Viewing the System Setup Program Pages

1. Turn on (or restart) your computer.
2. When the Dell™ logo appears, press <F2> immediately.

If you wait too long and the Windows® logo appears, continue to wait until you see the Windows desktop. Then shut down your computer and try again.

[Back to Contents Page](#)

[Back to Contents Page](#)

Ports and Connector Pin-Outs

Dell™ Inspiron™ 4000

- [Port Locations](#)
- [Serial Connector](#)
- [Parallel Connector](#)
- [Docking Connector](#)
- [PS/2 Connector](#)
- [USB Connector](#)
- [Video Connector](#)
- [S-Video TV-Out Connector](#)

Port Locations

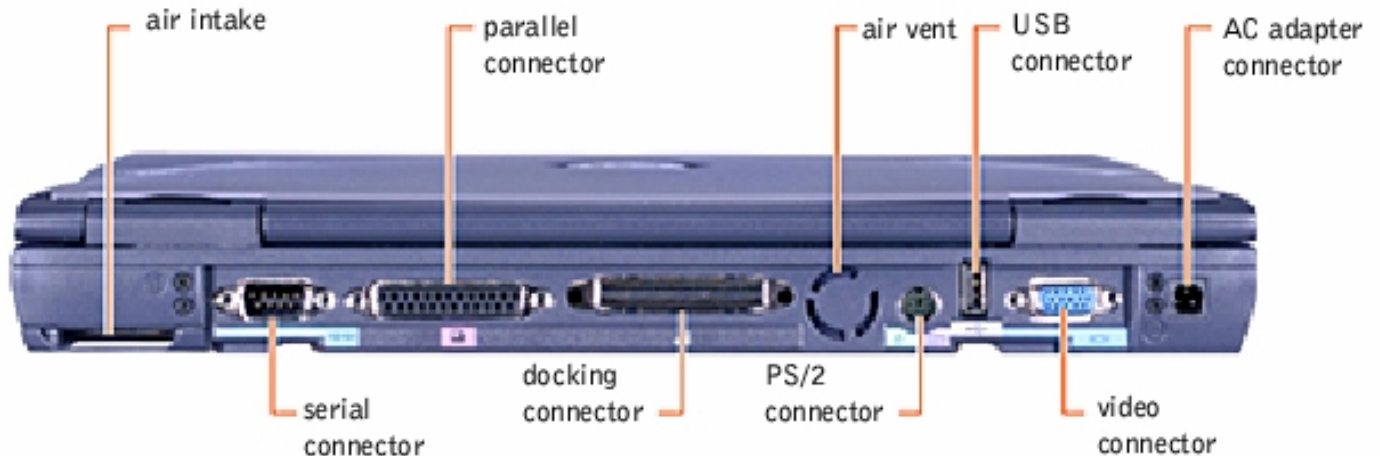

Serial Connector

Use the 9-pin serial connector to attach a serial device to the computer. The serial connector passes data in serial format (1 bit at a time over one line). This connector supports a variety of devices, including a serial mouse, that require serial data transmission. If you reconfigure your hardware, you may need pin number and signal information for the serial connector.



Pin	Signal	I/O	Definition
1	DCD	I	Data carrier detect
2	RXDA	I	Receive data
3	TXDA	O	Transmit data
4	DTR	O	Data terminal ready
5	GND	N/A	Signal ground
6	DSR	I	Data set ready
7	RTS	O	Request to send
8	CTS	I	Clear to send
9	RI	I	Ring indicator
Shell	N/A	N/A	Frame ground

Parallel Connector

Use the 25-hole parallel connector to attach a parallel device to the computer. The parallel connector is used primarily for printers. The parallel connector transmits data in parallel format, where 8 data bits (one byte) are sent simultaneously over eight separate lines.

The parallel connector can also be configured for compatibility with the PS/2 standard. Support for the EPP feature improves network adapter performance (adapters connect to the computer's parallel connector and require the appropriate software drivers from the adapter's manufacturer).

If you reconfigure your hardware, you may need pin number and signal information for the parallel connector.



13 12 11 10 9 8 7 6 5 4 3 2 1
25 24 23 22 21 20 19 18 17 16 15 14

Pin	Signal	I/O	Definition
1	STB#	I/O	Strobe
2	D0	I/O	Printer data bit 0
3	PD1	I/O	Printer data bit 1
4	PD2	I/O	Printer data bit 2
5	PD3	I/O	Printer data bit 3
6	PD4	I/O	Printer data bit 4
7	PD5	I/O	Printer data bit 5
8	PD6	I/O	Printer data bit 6
9	PD7	I/O	Printer data bit 7
10	ACK#	I	Acknowledge
11	BUSY	I	Busy
12	PE	I	Paper end
13	SLCT	I	Select
14	AFD#	O	Automatic feed
15	ERR#	I	Error
16	INIT#	O	Initialize printer
17	SLIN#	O	Select in
18-25	N/A	N/A	Ground signal
Shell	N/A	N/A	Frame ground

Docking Connector

Use this connector to attach your computer to the optional port replicator.

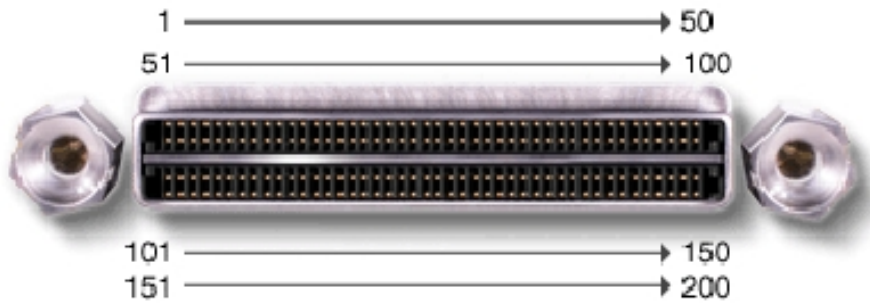

Pin	Signal	Pin	Signal	Pin	Signal	Pin	Signal
1	STRB#/5V	51	HSYNC	101	VGA_GRN	151	GND
2	PD0	52	VSYNC	102	GND	152	CLK_SPCI
3	PD1	53	GND	103	VGA_RED	153	GND
4	PD2	54	DOCKED	104	GND	154	SAD0
5	PD3	55	USB_VD1+	105	VGA_BLU	155	SAD1
6	PD4	56	USB_VD1-	106	DOCK_SD/MODE	156	SAD2
7	PD5	57	GND	107	D_IRTX	157	SAD3
8	PD6	58	USB_VD2+	108	D_IRRX	158	SAD4
9	PD7	59	USB_VD2-	109	GND	159	SAD5
10	GND	60	DOCKOC1#	110	SPIRQB#	160	SAD6
11	DOC_SPKR	61	RUN_ON#	111	SPIRQC#	161	GND
12	DOCK_MIC	62	GND	112	DAT_DDC2	162	SAD7
13	DOCK_LINE	63	NC	113	CLK_DDC2	163	SAD8
14	DOCK_CDROM	64	DOCK_SCLK	114	SPAR	164	SC/BE0#
15	GND	65	DOCK_LRCK	115	SPME#	165	SAD9
16	M_SEN#	66	DOCK_MCLK	116	GND	166	SAD10
17	POWER_SW#	67	GND	117	SSERR#	167	SAD11
18	QPCIEN#	68	+12V	118	SPERR#	168	SAD12
19	S1.6M_EN#	69	AFD#	119	SLOCK#	169	GND
20	DFDD/LPT#	70	ERROR#	120	SSTOP#	170	SAD13
21	GND	71	ACK#	121	GND	171	SAD14
22	NC	72	GND	122	SDEVSEL#	172	SAD15
23	NC	73	INIT#	123	STRDY#	173	SAD16
24	D_ATCTLED	74	SLCT_IN#	124	SIRDY#	174	SC/BE1#
25	D_PWRLED	75	BUSY	125	SFRAME#	175	SC/BE2#
26	DOCK_PWR_SRC	76	PE	126	SCLKRUN#	176	GND
27	DOCK_PWR_SRC	77	SLCT	127	GND	177	SAD17

28	DOCK_PWR_SRC	78	GND	128	SGNTA#	178	SAD18
29	GND	79	DAT_SMB	129	SREQA#	179	SAD19
30	+5VDOCK	80	DCLK_SMB	130	SGNT0#	180	SAD20
31	+5VDOCK	81	SMB_INIT#	131	SREQ0#	181	SAD21
32	+5VDOCK	82	GND	132	SPCIRST#	182	GND
33	+5VDOCK	83	DAT_DOCSM1	133	SH1SEL#	183	SAD22
34	+5VDOCK	84	CLK_DOCKSM1	134	GND	184	SAD23
35	GND	85	DAT_DOCKBD	135	SWRPRT#	185	SAD24
36	DOCK_PWR_SRC	86	CLK_DOCKBD	136	SDSKCHG#/DRQ	186	SC/BE3#
37	DOCK_PWR_SRC	87	GND	137	SDIR#	187	SAD25
38	DOCK_PWR_SRC	88	R10	138	STRK0#	188	GND
39	DOCK_PWR_SRC	89	CTS0	139	SSTEP#	189	SAD26
40	GND	90	RTS0	140	SDRV1#	190	SAD27
41	DOCK_+DC_IN	91	DSR0	141	GND	191	SAD28
42	DOCK_+DC_IN	92	GND	142	SMRT1#	192	SAD29
43	DOCK_+DC_IN	93	DTR0	143	SWRDATA#	193	SAD30
44	DOCK_+DC_IN	94	TXD0#	144	SWGATE#	194	SAD31
45	DOCK_+DC_IN	95	RXD0#	145	SRDATA#	195	GND
46	DOCK_+DC_IN	96	DCD0	146	SINDEX#	196	NC
47	DOCK_+DC_IN	97	NC	147	GND	197	NC
48	DOCK_+DC_IN	98	+5VSUS	148	NC	198	NC
49	GND	99	NC	149	+5VALW	199	NC
50	LOW_PWR	100	NC	150	NC	200	GND

PS/2 Connector

Use the 6-hole, miniature DIN PS/2 connector to attach PS/2-compatible devices such as a mouse, keyboard, or external numeric keypad. If you reconfigure your hardware, you may need pin number and signal information for the PS/2 connector.

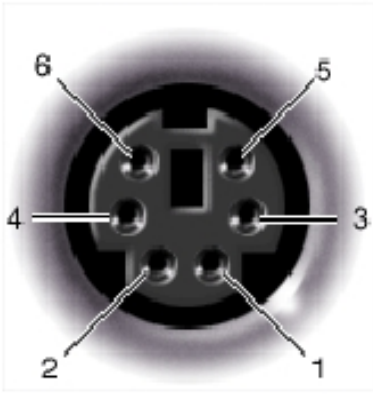

Pin	Signal	I/O	Definition
1	EXK_MSDATA	I/O	External keyboard/keypad/mouse data
2	KBD_DATA	I	Keyboard data
3	GND	N/A	Signal ground
4	EXK_MSPWR	N/A	External keyboard/keypad/mouse supply voltage
5	EXK_MSCLK	I/O	External keyboard/keypad/mouse clock
6	KBD_CLK	I	Keyboard clock
Shell	N/A	N/A	Chassis ground

USB Connector

Use the USB connector to attach one or more USB devices, such as a mouse, to the computer. USB is a peripheral standard that enables automatic detection of USB-compliant peripheral devices.

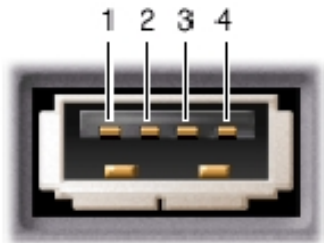

Pin	Signal	Definition
1	VCC	Cable power
2	- Data	N/A
3	+Data	N/A

4	Ground	Cable ground
---	--------	--------------

Video Connector

Use the 15-pin video connector to attach an external monitor to the computer. If the image does not appear on the monitor immediately, press <Fn><F8>.



Pin	Signal	I/O	Definition
1	RED	O	Red video
2	GREEN	O	Green video
3	BLUE	O	Blue video
4	DDC2_MONID2	I	Monitor detect ID2
5	GND	N/A	Signal ground
6	GND	N/A	Signal ground
7	GND	N/A	Signal ground
8	GND	N/A	Signal ground
9	CRTVCC	O	5-V power source for CRT
10	GND	N/A	Signal ground
11	M-SEN#	I	Digital monitor sense/monitor detect ID1
12	DDC_DATA	I	Monitor detect serial data
13	HSYNC	O	Horizontal synchronization
14	VSYNC	O	Vertical synchronization
15	DDC_CLK	1	Monitor Detect serial clock
Shell	N/A	N/A	Frame ground

S-Video TV-Out Connector

Use this connector on the right side of the computer to connect your computer to a television.

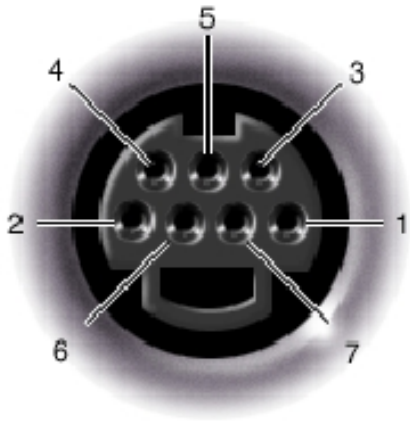

S-Video		Composite Video	
Pin	Signal	Pin	Signal
1	GND	5	NC
2	GND	6	DCMPS-L
3	DLUMA-L	7	GND
4	DCRMA-L		

[Back to Contents Page](#)

[Back to Contents Page](#)

Removing and Replacing Parts

Dell™ Inspiron™ 4000

- [Preparing to Work Inside the Computer](#)
- [Recommended Tools](#)
- [Screw Identification](#)
- [System Components](#)
- [Replacing the Palm Rests](#)
- [Replacing the Display Cover](#)
- [Hard Drive Assembly](#)
- [Modular Bay Devices](#)
- [Memory Module](#)
- [Mini PCI Card Assembly](#)
- [Keyboard Assembly](#)
- [Removing the Display Assembly](#)
- [Display Assembly Latch](#)
- [Hinge Covers](#)
- [Palm Rest Assembly](#)
- [Microprocessor Thermal Cooling Assembly](#)
- [Microprocessor Module](#)
- [Reserve Battery](#)
- [System Speaker Assembly](#)
- [System Board Assembly](#)
- [Module Latch Assemblies](#)

Preparing to Work Inside the Computer

- ➔ **NOTICE:** Only a certified service technician should perform repairs on your computer. Damage or inoperability due to servicing not authorized by Dell is not covered by your warranty.
- ➔ **NOTICE:** Unless otherwise noted, each procedure in this manual assumes that a part can be replaced by performing the removal procedure in reverse order.
- ➔ **NOTICE:** To avoid damaging the computer, perform the following steps before you begin working inside the computer.

1. Make sure that the work surface is clean to prevent scratching the computer cover.
2. Save and close any open files, and exit any open programs.

 **HINT:** Make sure the computer is turned off and not in standby or hibernate mode. If you cannot shut down the computer using the computer's operating system, press and hold the power button for 4 seconds.

3. Turn off the computer and all attached devices.
4. Make sure the computer is undocked.
5. Disconnect the computer from the electrical outlet.

6. To avoid possible damage to the system board, wait 10 to 20 seconds and then disconnect any attached devices.
7. Disconnect all other external cables from the computer.
8. Remove any installed PC Cards or plastic blanks from the PC Card slot.
9. Close the display and turn the computer upside down on a flat work surface.
10. Remove the primary battery from the battery bay and the secondary battery from the modular bay, if a secondary battery is in use.



NOTICE: To avoid damaging the system board, you must remove the main battery and secondary battery (if present) before you service the computer.

11. Remove any installed device in the modular bay.
12. To dissipate any static electricity while you work, periodically touch an unpainted metal surface on the computer, such as the I/O panel on the back of the computer chassis.
13. Handle components and cards with care. Do not touch the components or contacts on a card. Hold a card by its edges or by its metal mounting bracket. Hold a component such as a microprocessor by its edges, not by its pins.

Recommended Tools

The procedures in this manual require the following tools:

- #1 magnetized Phillips screwdriver
- Small flat-blade screwdriver
- Small plastic scribe
- Microprocessor extractor
- Flash BIOS update program floppy disk or CD (required only when upgrading the microprocessor, replacing the reserve battery, or replacing the system board)

Screw Identification

When you are removing and replacing components, photocopy the screw placemat as a tool to lay out and keep track of the component screws. The placemat provides the number of screws and the sizes.



M2.5x12 mm



M3 x 5 mm



M2.5 x 5 mm



M2 x 4 mm

















M2 x 3 mm



NOTICE: When reinstalling a screw, you must use a screw of the correct diameter and length. Make sure that the screw is properly aligned with its corresponding hole, and avoid over tightening.

Screw Placement

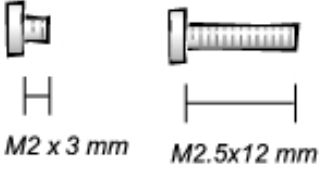
<p>Hard Drive Door Security:</p> <p>M3 x 5 (1 each)</p>   <p><i>M3 x 5 mm</i></p>	<p>Keyboard to Bottom Case Assembly:</p> <p>M2.5 x 12 (5 each)</p>   <p><i>M2.5x12 mm</i></p>	<p>LCD Display Bezel:</p> <p>M2.5 x 5 (4 each)</p> <p>Rubber Screw Covers (4 each)</p>   <p><i>M2.5 x 5 mm</i></p>
<p>LCD Hinge Bracket to Bottom Case Assembly:</p> <p>M2.5 x 5 (5 each)</p>   <p><i>M2.5 x 5 mm</i></p>	<p>14.1-Inch LCD Display Assembly and Flex-Cable Retention Bracket to Top Cover:</p> <p>M2 x 4 (5 each)</p>   <p><i>M2 x 4 mm</i></p>	<p>Display Assembly EMI Shield Bracket:</p> <p>M2 x 3 (5 each)</p>   <p><i>M2 x 3 mm</i></p>
Empty space for additional screw placement information		

<p>Palm Rest to Bottom Case Assembly:</p> <p>M2 x 3 (5 each) M2.5 x 12 (3 each)</p>  <p>M2 x 3 mm M2.5x12 mm</p>	<p>Hybrid Cooling Fan:</p> <p>M2.5 x 5 (2 each)</p>  <p>M2.5 x 5 mm</p>	<p>System Board to Bottom Case Assembly:</p> <p>M2.5 x 5 (10 each)</p>  <p>M2.5 x 5 mm</p>
--	---	---

System Components

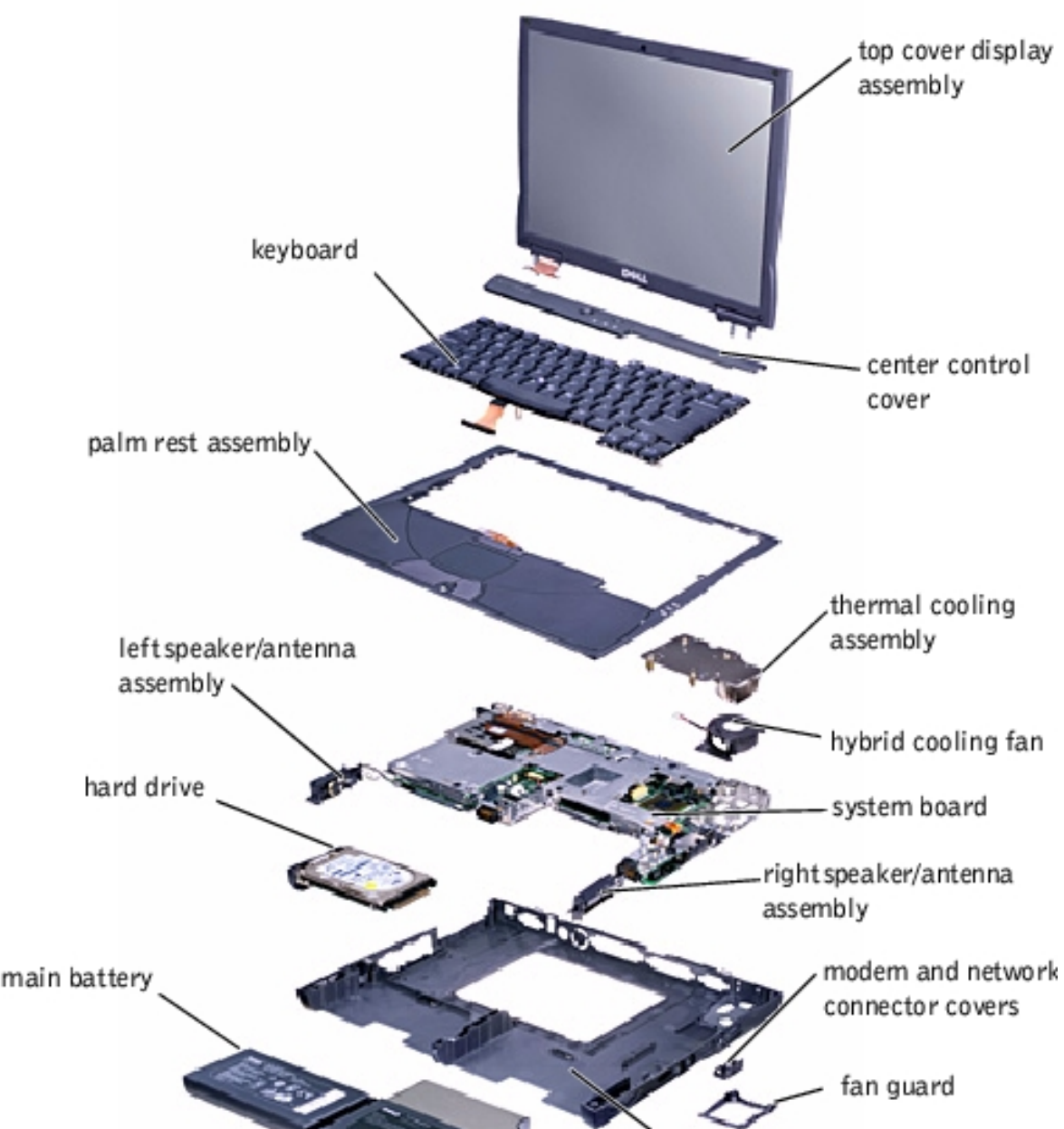



Replacing the Palm Rests

1. Save and close any open files, exit any open programs, and shut down the computer.
2. If the computer is connected (docked) to an advanced port replicator (APR), undock it.
3. Keep the display open and tilt the computer back so that you can access the bottom of the computer.
4. Slide and hold the latch release on the left side, and remove any device installed in the modular bay.
5. Slide and hold the latch release on the right side, and remove any battery installed in the battery bay.
6. Locate the orange palm rest removal buttons. Firmly press the buttons with the eraser end of a pencil (or a dull utensil smaller than your finger) to release the palm rests.

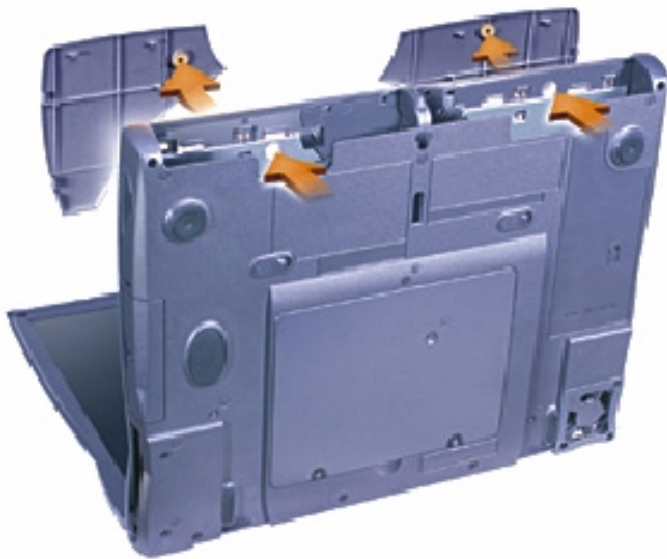

7. Remove the palm rests.
8. To replace the palm rests, insert the tabs on the inside edge of the palm rest into the slots on the computer. Then press along the outside edges of the palm rest until it snaps into place.

Repeat the process on each side.



Replacing the Display Cover

1. Slide your index fingers under the straight edge of the display cover until the cover pops out.
2. Slide the display cover towards the back of the computer.



3. Use your fingers to release the cover completely, and remove it.
4. To replace the display cover, bend it slightly to insert the four tabs on the rounded edge of the cover into the slots on the top of the computer.

5. Press the cover along the straight edge at the back of the computer until it snaps into place.
6. Firmly press the Dell logo until it snaps into place. Press above both hinge covers to engage the final snaps.

Hard Drive Assembly

- ➔ **NOTICE:** The hard drive is very sensitive to shock. Handle the assembly by its edges (do not squeeze the top of the hard drive case), and avoid dropping it.

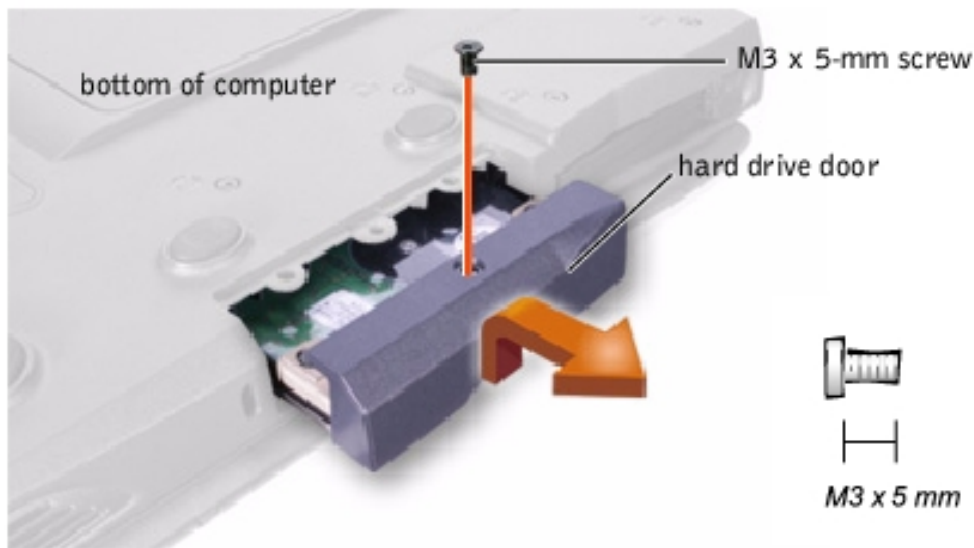

Removing the Hard Drive Assembly

- ➔ **NOTICE:** Disconnect the computer and any attached devices from electrical outlets, and remove any installed batteries.
- ➔ **NOTICE:** To avoid ESD, ground yourself by using a wrist grounding strap or by touching an unpainted metal surface on the computer.
- ➔ **NOTICE:** Read "[Preparing to Work Inside the Computer](#)" before performing the following procedure.

1. Remove the screw from the hard drive door.
2. Slide the drive door up until the drive assembly tabs disengage from the door slots in the bottom case assembly.
3. Pull the drive assembly straight out of the bottom case assembly.

Replacing the Hard Drive Assembly

1. Push the drive assembly into the hard drive opening of the computer.

2. Align the drive assembly tabs with the bottom case assembly slots and push down until it clicks into place.
3. Replace the screw in the drive door.

Modular Bay Devices

- ➔ **NOTICE:** Disconnect the computer and any attached devices from electrical outlets, and remove any installed batteries.
 - ➔ **NOTICE:** To avoid ESD, ground yourself by using a wrist grounding strap or by touching an unpainted metal surface on the computer.
 - ➔ **NOTICE:** Read "[Preparing to Work Inside the Computer](#)" before performing the following procedure.
1. Close the display, and turn the computer upside down on a flat work surface.
 2. Slide the modular bay latch toward the right.
 3. Keep holding the latch open while you pull the device out of the modular bay with the other hand.

Memory Module

- ➔ **NOTICE:** The only time you should ever access the inside of your computer is when you are installing memory modules or a Mini PCI card.



Removing the Memory Module Cover

- ➔ **NOTICE:** Disconnect the computer and any attached devices from electrical outlets, and remove any installed batteries.
- ➔ **NOTICE:** To avoid ESD, ground yourself by using a wrist grounding strap or by touching an unpainted metal surface on the computer.
- ➔ **NOTICE:** Read "[Preparing to Work Inside the Computer](#)" before performing the following procedure.

1. Remove the memory module cover:

🔩 **HINT:** The screw labeled with the "circle K" in the middle of the memory module cover secures the keyboard assembly and does not secure the memory module cover.

- a. Use a coin or flat-blade screwdriver to release the two captive screws that secure the memory module cover.
- b. Place your finger under the cover at the indentation and lift and slide the cover open.

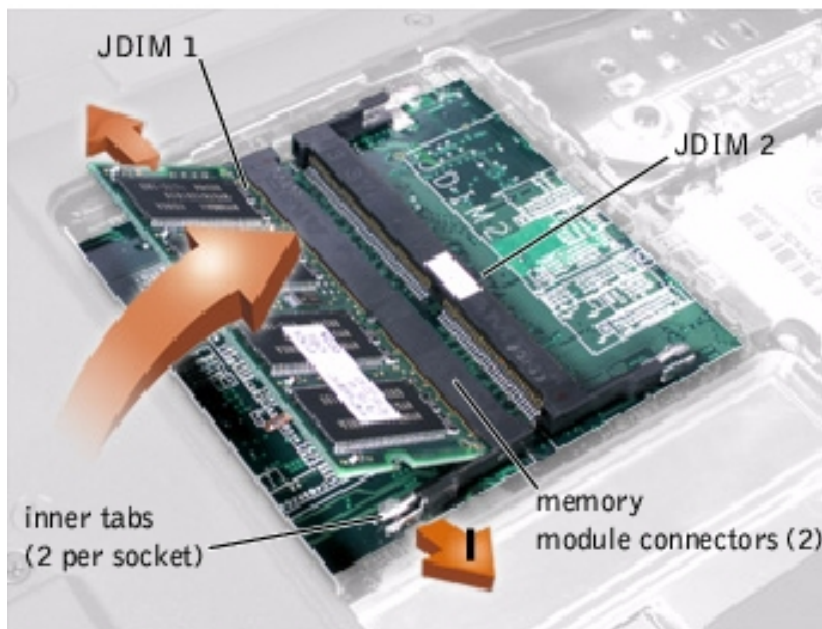

Removing the Memory Modules

- ➔ **NOTICE:** Disconnect the computer and any attached devices from electrical outlets, and remove any installed batteries.
- ➔ **NOTICE:** To avoid ESD, ground yourself by using a wrist grounding strap or by touching an unpainted metal surface on the computer.
- ➔ **NOTICE:** Read "[Preparing to Work Inside the Computer](#)" before performing the following procedure.

1. Remove the [memory module cover](#).

 **NOTICE:** Handle memory modules with care. Do not touch the components on a module. Hold the module by its edges.

2. To release a memory module from its connector, spread apart the inner tabs of the memory module connector just far enough for the memory module to disengage from the connector. The module should pop up slightly.
3. Lift the memory module out of its connector.

Replacing the Memory Modules

1. If you only have one memory module, install it in the connector labeled "JDIM1." If you have two memory modules, install the second module in the connector labeled "JDIM2."

 **HINT:** Memory modules are keyed, or designed to fit into their connectors, in only one direction.

2. Align the memory module's edge connector with the slot in the center of the memory module connector. With the module at a 45-degree angle, press the memory module's edge connector firmly into the memory module connector.
3. Pivot the memory module down until it clicks into place. If you do not hear a click, remove the memory module and reinstall it.
4. Insert the tabs on the memory module cover into the bottom case assembly. Rotate the memory module cover down and tighten the two captive screws.

Mini PCI Card Assembly

 **NOTICE:** The only time you should ever access the inside of your computer is when you are installing memory modules or a Mini PCI card.

The optional Mini PCI card assembly may contain either a modem, network adapter, or combination of both. You must remove the Mini PCI card subassembly before the system board assembly can be removed. The Mini PCI card subassembly must be connected to the internal antenna for proper operation.

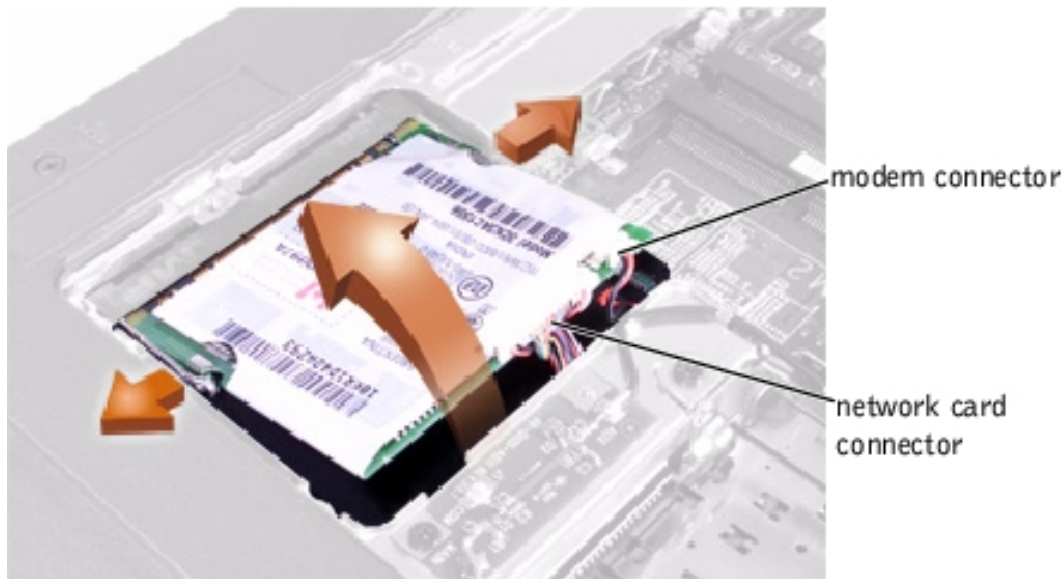

Removing the Mini PCI Card Assembly

- ➡ **NOTICE:** Disconnect the computer and any attached devices from electrical outlets, and remove any installed batteries.
 - ➡ **NOTICE:** To avoid ESD, ground yourself by using a wrist grounding strap or by touching an unpainted metal surface on the computer.
 - ➡ **NOTICE:** Read "[Preparing to Work Inside the Computer](#)" before performing the following procedure.
1. Remove the [memory module cover](#).
 2. To release a Mini PCI card subassembly from its connector, spread apart the inner tabs of the connector just far enough for the Mini PCI card assembly to disengage from the connector. The module should pop up slightly from the interface connector.
 3. Lift the Mini PCI card subassembly out of its connector and disconnect any attached cables.

Replacing the Mini PCI Card Assembly

1. Align and press the Mini PCI card subassembly into the system board interface connector.

🔧 **HINT:** A modem-only Mini PCI card has only one cable and connector.

2. Connect the interface cables.
3. Replace the memory module cover.

Keyboard Assembly

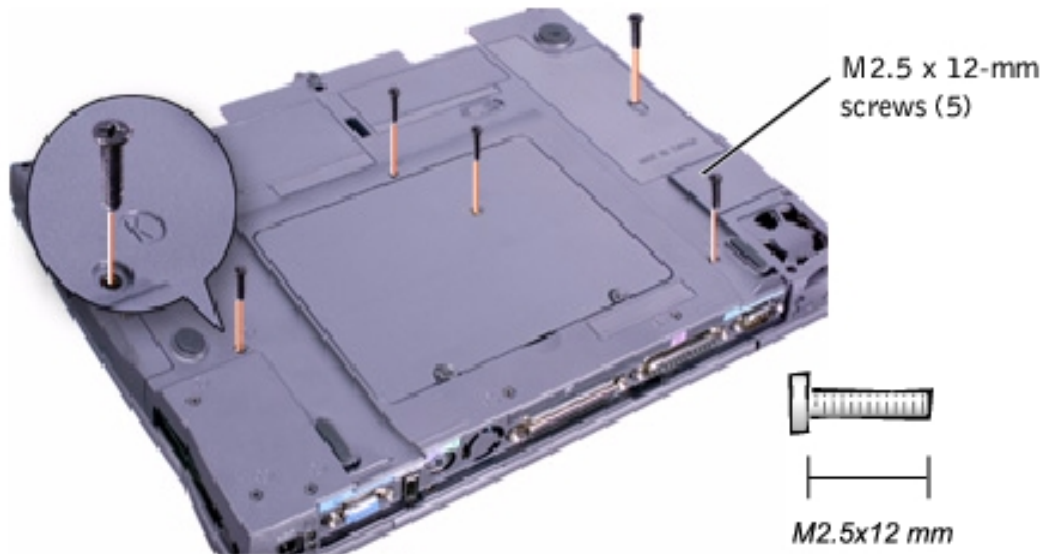

Removing the Keyboard Assembly

- ➔ **NOTICE:** Disconnect the computer and any attached devices from electrical outlets, and remove any installed batteries.
 - ➔ **NOTICE:** To avoid ESD, ground yourself by using a wrist grounding strap or by touching an unpainted metal surface on the computer.
 - ➔ **NOTICE:** Read "[Preparing to Work Inside the Computer](#)" before performing the following procedure.
1. Remove the [hard drive assembly](#).
 2. Turn the computer bottom-side up, and remove the five screws labeled with a "circle K."
 3. Turn the computer right-side up and open the display.
- ➔ **NOTICE:** The key caps on the keyboard are fragile, easily dislodged, and time-consuming to replace. Be careful when removing and handling the keyboard.
4. Insert a small, flat-blade screwdriver or plastic scribe into the scalloped edge next to the right <Shift> key, and release the keyboard from the palm rest assembly.



5. Lift the keyboard straight up until it clears the keyboard boss support in the bottom case assembly.
6. Rotate the keyboard forward toward the front of the computer.
7. Rest the key face of the keyboard on the palm rest.

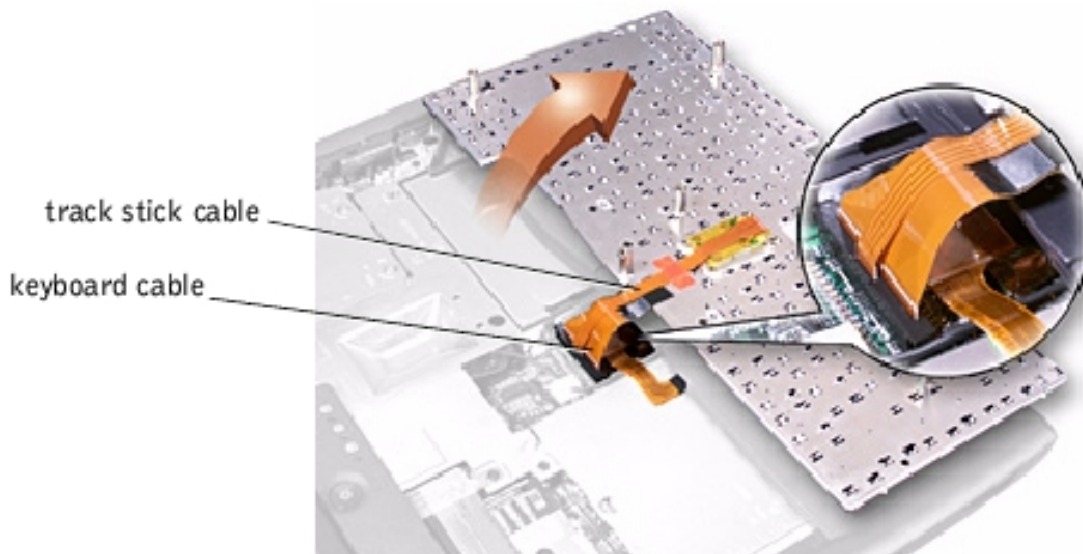

8. Disconnect the keyboard flex cable from the interface connector on the system board assembly by pulling up on the connector.
9. Remove the keyboard assembly from the bottom case assembly.

Replacing the Keyboard Assembly

1. Place the keyboard on the palm rest at the front of the computer with the keys facing down and the connector toward the back of the computer.
2. Connect the keyboard flex cable to the interface connector on the system board assembly.

-  **NOTICE:** Position the keyboard cable so that it does not pinch when you replace the keyboard in the bottom case assembly.

 - 3. Carefully turn the keyboard over and fit the keyboard into place.
 - 4. Check that the keyboard is correctly installed. The keys should be flush with the left and right surfaces of the palm rest.

 -  **NOTICE:** Make sure that the keyboard is aligned correctly to avoid stripping the screws the next time they are removed.

 - 5. Reinstall the five M2.5 x 12-mm screws in the holes labeled "circle K."

 -  **NOTICE:** You must remove the display assembly before you remove the palm rest assembly; the display assembly hinges pass through the back of the palm rest assembly.
-

Removing the Display Assembly

-  **HINT:** Always remove and replace the LCD panel as a complete assembly.

-  **NOTICE:** Disconnect the computer and any attached devices from electrical outlets, and remove any installed batteries.

-  **NOTICE:** To avoid ESD, ground yourself by using a wrist grounding strap or by touching an unpainted metal surface on the computer.

-  **NOTICE:** Read "[Preparing to Work Inside the Computer](#)" before performing the following procedure.

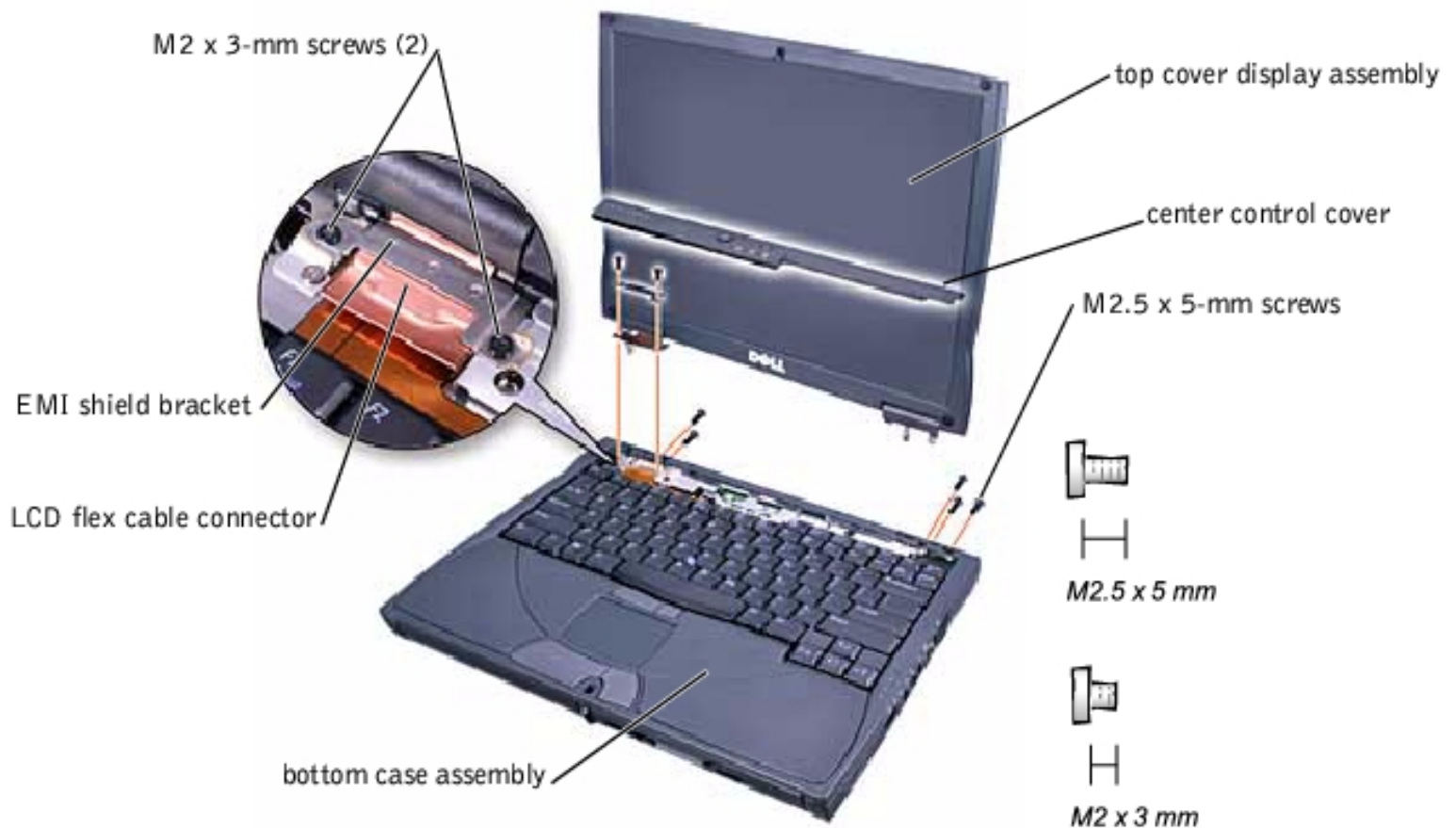

1. Remove the [hard drive assembly](#).
2. Remove the center control cover:
 - a. Use a scribe to lift the right edge of the center control cover and pry it loose from the bottom case assembly.
 - b. Lift the center control cover up and away from the bottom case assembly.
3. Close the display. From the back of the computer, remove the five screws labeled with the "circle D." There are two screws on the right hinge and three screws on the left hinge.
4. Open the display assembly approximately 90 degrees, and support the display assembly so that it does not open past this position.
5. Remove the two M2 x 3-mm screws that secure the EMI shield bracket (metal) to the system board assembly.
6. Remove the flex cable EMI shield retention bracket that covers the display flex cable connector on the system board.
7. Pull straight up on the loop attached to the interface cable connector to disconnect the display flex cable from the system board.
8. Lift the display assembly from the bottom case assembly.



HINT: The right plastic hinge cover is labeled "R" and the left plastic hinge cover is labeled "L."

9. Remove the right and left plastic hinge covers from the hinges.



NOTICE: When reconnecting the display-feed cable connector to the system board, push down on the top left and right ends of the connector. Pressing on the center of the connector might damage resistors and compromise EMI protection in the computer.



Removing the 14.1-Inch Display Assembly Bezel

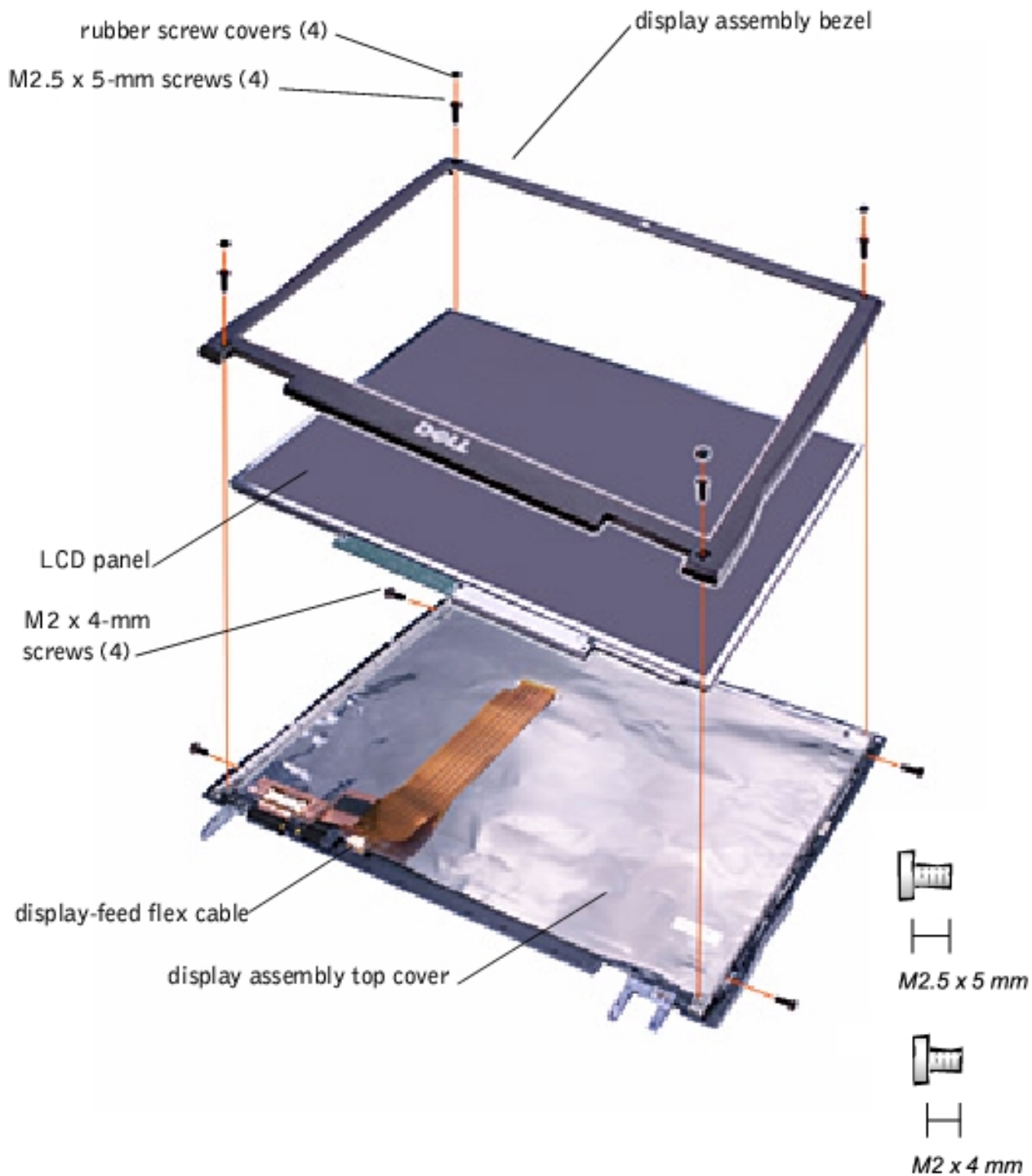

- ➔ **NOTICE:** Disconnect the computer and any attached devices from electrical outlets, and remove any installed batteries.
- ➔ **NOTICE:** To avoid ESD, ground yourself by using a wrist grounding strap or by touching an unpainted metal surface on the computer.
- ➔ **NOTICE:** Read "[Preparing to Work Inside the Computer](#)" before performing the following procedure.

1. Remove the [hard drive assembly](#).

2. Remove the [display assembly](#).
3. Use the scribe to pry the four rubber screw covers out of the screw holes located at the four corners of the bezel on the front of the display assembly.
4. Remove the four M2.5 x 5-mm screws located at the corners of the bezel on the front of the display assembly.

 **NOTICE:** Some of the bezel snaps may be difficult to remove, so be careful when separating the bezel from the display assembly.

5. Use a plastic scribe and separate the bezel from the display-assembly top cover.
6. Be careful not to lose the display magnet on the right side of the back cover. The polarity of the magnet is marked with a minus "-" sign and oriented toward the bottom of the display. Make sure to replace the magnet in the same orientation when you reassemble the display.

Removing the 14.1-Inch LCD Panel

 **NOTICE:** Disconnect the computer and any attached devices from electrical outlets, and remove any installed batteries.

 **NOTICE:** To avoid ESD, ground yourself by using a wrist grounding strap or by touching an unpainted metal surface on the computer.

 **NOTICE:** Read "[Preparing to Work Inside the Computer](#)" before performing the following procedure.

1. Remove the [hard drive assembly](#).
2. Remove the [display assembly](#).
3. Remove the [display assembly bezel](#).
4. Remove the two M2 x 4-mm screws on the left side of the LCD panel and the two M2 x 4-mm screws on the right side of the LCD panel.
5. Remove the M2 x 4-mm screw that secures the display flex cable to the display assembly through the flex-cable retention bracket (black plastic).
6. Lift and rotate the top of the LCD panel out of the top cover.

Replacing the 14.1-Inch LCD Panel

 **HINT:** Use a magnetic screwdriver to reassemble the LCD panel in the display, and secure the right side first. Make sure to replace the magnet with the minus sign toward the bottom of the display.

1. Place the bottom edge of the LCD panel in the bottom of the top cover, and elevate the top of the panel with your hand.
2. Lay the LCD panel in the top cover.
3. Reinstall the five M2 x 4-mm screws securing the LCD panel to the top cover.

Removing the Display-Feed Flex Cable

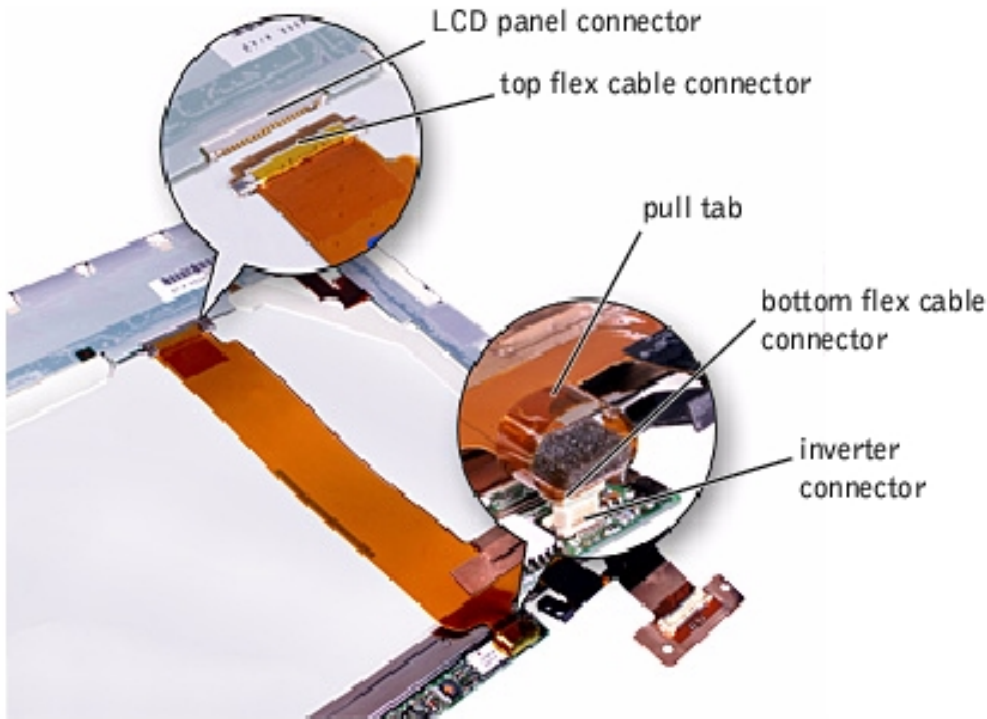

- ➡ **NOTICE:** Disconnect the computer and any attached devices from electrical outlets, and remove any installed batteries.
 - ➡ **NOTICE:** To avoid ESD, ground yourself by using a wrist grounding strap or by touching an unpainted metal surface on the computer.
 - ➡ **NOTICE:** Read "[Preparing to Work Inside the Computer](#)" before performing the following procedure.
1. Remove the [hard drive assembly](#).
 2. Remove the [display assembly](#).
 3. Remove the [display assembly bezel](#).
 4. Remove the tape that covers the connector to the LCD panel located at the top of the display-feed flex cable.
 5. Hold the connector at the top of the display-feed flex cable, and pull down and away to remove it from the LCD panel.

Display Assembly Latch

- ➡ **NOTICE:** Disconnect the computer and any attached devices from electrical outlets, and remove any installed batteries.

- ➔ **NOTICE:** To avoid ESD, ground yourself by using a wrist grounding strap or by touching an unpainted metal surface on the computer.
- ➔ **NOTICE:** Read "[Preparing to Work Inside the Computer](#)" before performing the following procedure.

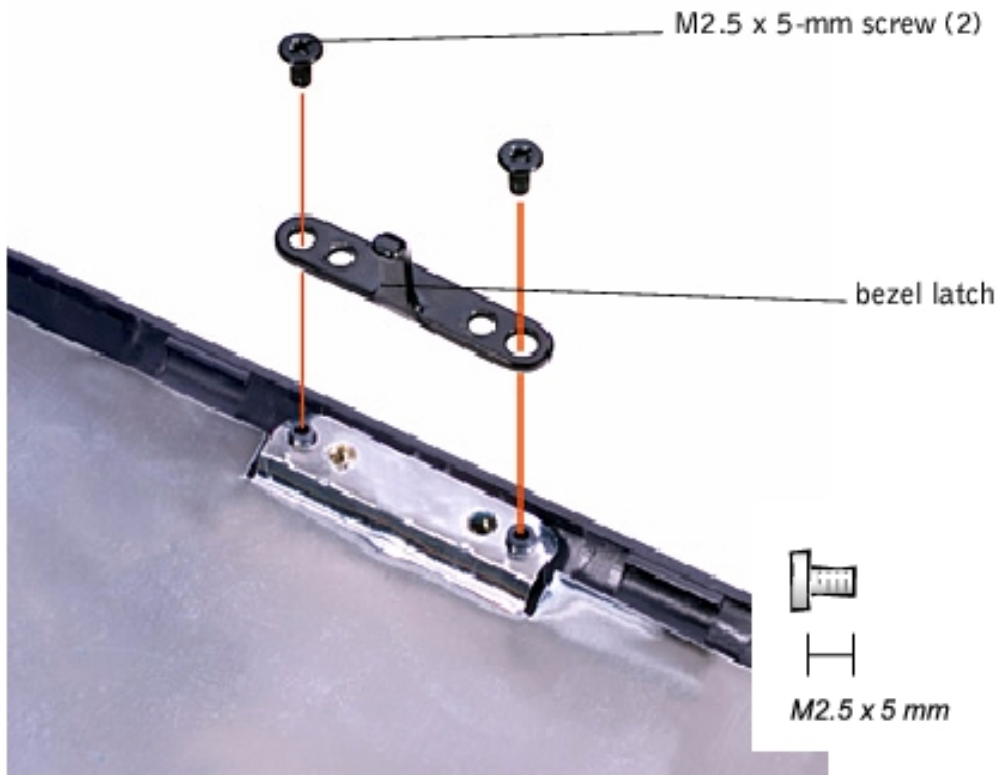

1. Remove the [hard drive assembly](#).
2. Remove the [display assembly](#).
3. Remove the [display assembly bezel](#).
4. Remove the display assembly bezel latch by removing the two M2.5 x 5-mm screws that secure it to the display assembly top cover.

Hinge Covers

Removing the Hinge Covers



1. Remove the [display assembly](#).
2. Remove the plastic hinge covers from the hinges.

Replacing the Hinge Covers

1. Attach the display assembly to the bottom case assembly.



HINT: The right hinge cover is labeled "R," and the left hinge cover is labeled "L." The labels face the back of the computer.

2. Close the display assembly and snap the hinge covers in place over the hinges.

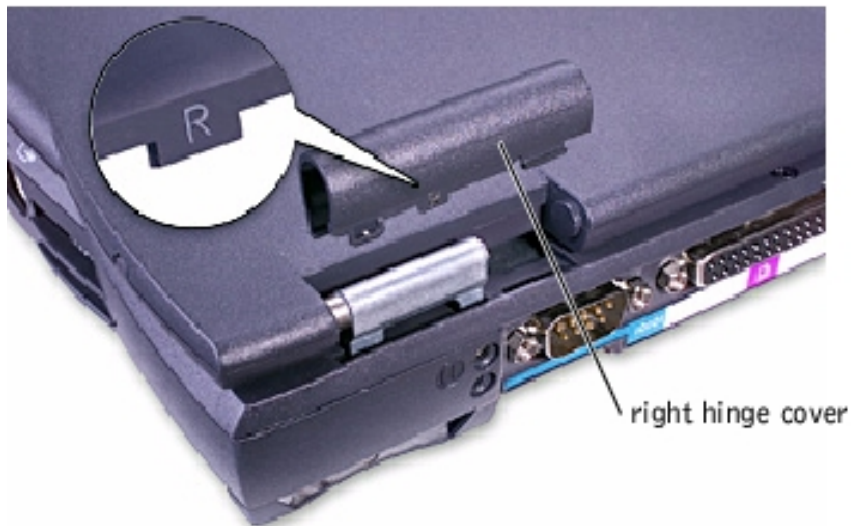

Palm Rest Assembly

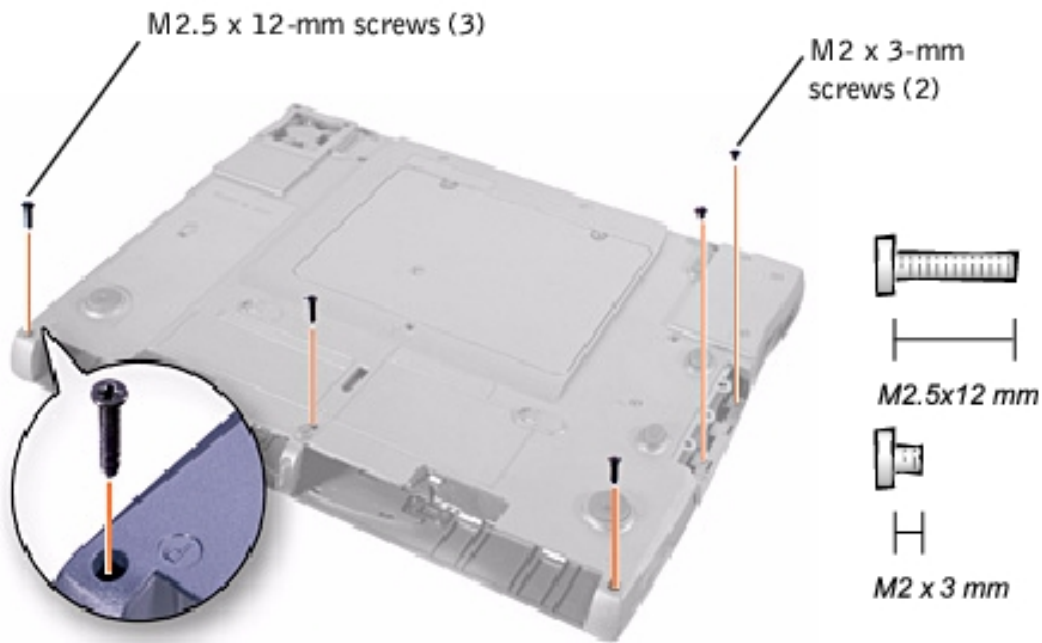

Removing the Palm Rest Assembly

- ➡ **NOTICE:** Disconnect the computer and any attached devices from electrical outlets, and remove any installed batteries.
 - ➡ **NOTICE:** To avoid ESD, ground yourself by using a wrist grounding strap or by touching an unpainted metal surface on the computer.
 - ➡ **NOTICE:** Read "[Preparing to Work Inside the Computer](#)" before performing the following procedure.
1. Remove the [hard drive assembly](#).
 2. Remove the [keyboard](#).
- ➡ **NOTICE:** You must remove the display assembly before you remove the palm rest assembly; the display assembly hinges pass through the back of the palm rest assembly.
3. Turn the computer right-side up on the work surface, and remove the display [hinge cover](#) and [display assembly](#).
 4. Turn the computer over and remove the three M2.5 x 12-mm screws labeled with a "circle P."
 5. Remove the five M2 x 3-mm screws that secure the palm rest to the bottom case assembly:
 - a. Remove the two M2 x 3-mm screws located in the hard drive bay door and labeled with a "circle P."
 - b. Remove the remaining two M2 x 3-mm screws located on the back edge of the bottom case assembly, underneath the display assembly.
 - c. Turn the bottom case assembly over. Remove the M2 x 3-mm screw located underneath the keyboard, on the right side of the bottom case assembly, next to the microprocessor thermal cooling assembly.

6. Pull up on the loop attached to the palm rest flex cable connector to remove it from the interface connector on the system board assembly.

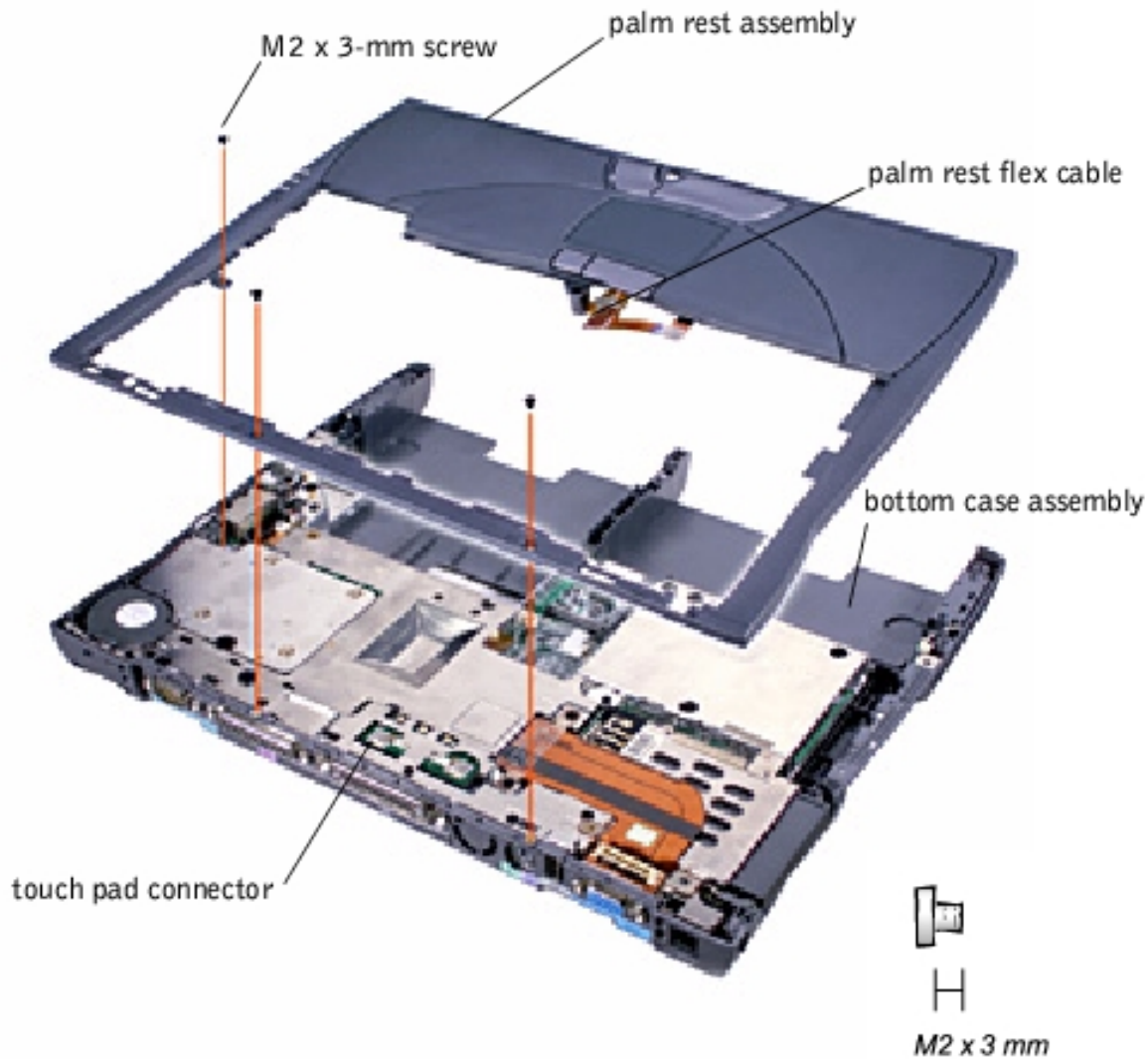

7. Using the plastic scribe along the edge of the plastic, remove the palm rest assembly from the bottom case assembly.

Microprocessor Thermal Cooling Assembly

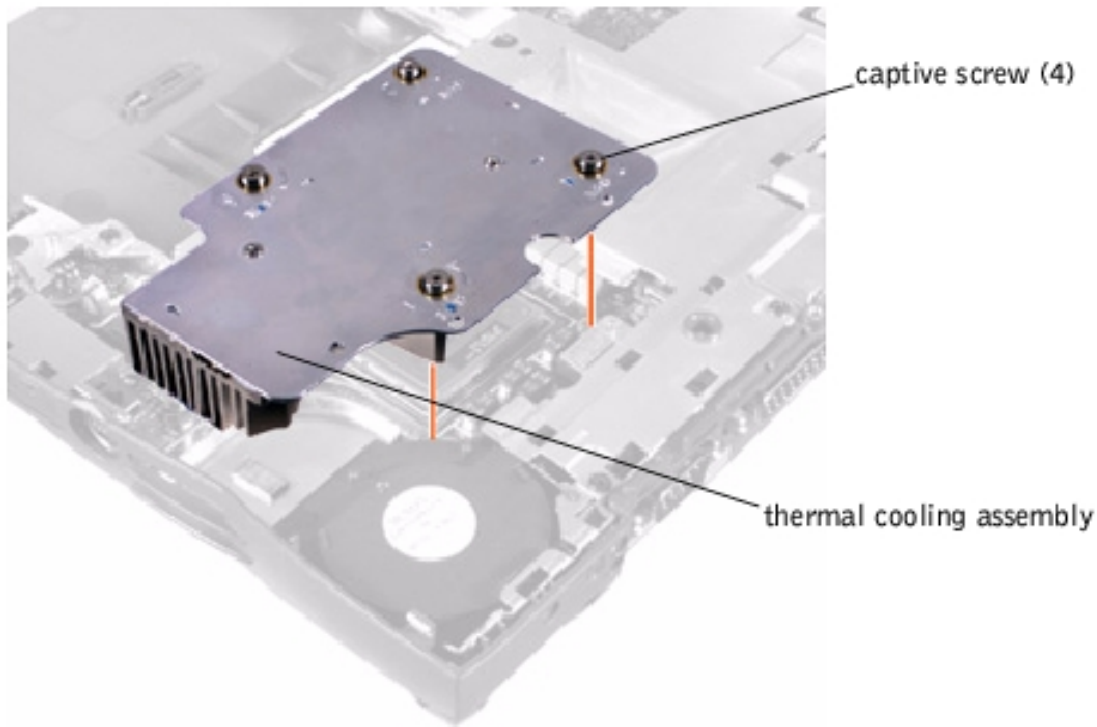

Removing the Microprocessor Thermal Cooling Assembly

- ➔ **NOTICE:** Disconnect the computer and any attached devices from electrical outlets, and remove any installed batteries.
- ➔ **NOTICE:** To avoid ESD, ground yourself by using a wrist grounding strap or by touching an unpainted metal surface on the computer.
- ➔ **NOTICE:** Read "[Preparing to Work Inside the Computer](#)" before performing the following procedure.

1. Remove the [hard drive assembly](#).
2. Turn the computer over and remove the [keyboard assembly](#).
3. Remove the [display assembly](#).
4. Loosen the four captive screws securing the microprocessor thermal cooling assembly.
5. Remove the microprocessor thermal cooling assembly from the system board assembly.

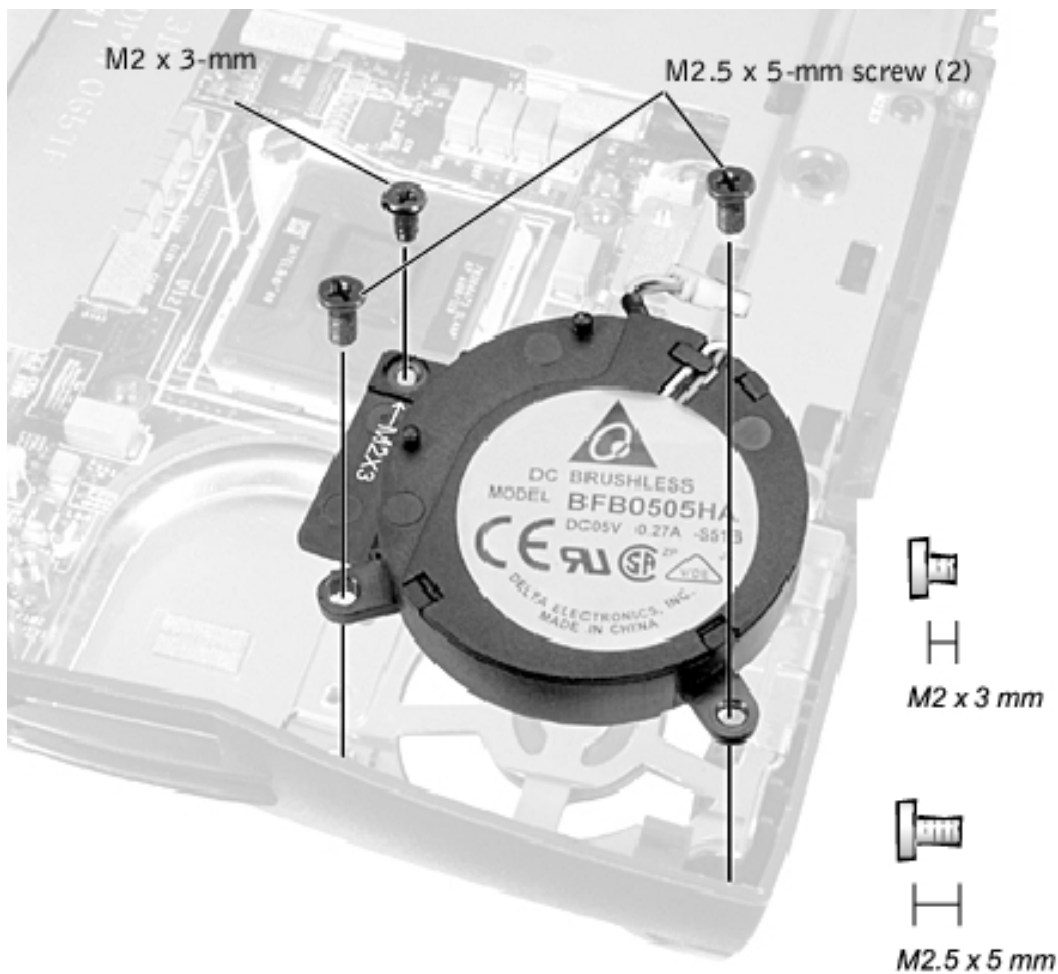

- Remove the two M2.5 x 5-mm screws and the one M2 x 3-mm screw that secure the hybrid cooling fan to the system board.

 **HINT:** The fan power cable is long and can be pulled out from under the EMI shield to provide access to the connector.

- Disconnect the fan power cable from the system board interface connector and remove the hybrid cooling fan.

 **CAUTION:** Do not block the keyboard screw hole when reinserting the fan cable.

Microprocessor Module

 **NOTICE:** Hold the microprocessor down while turning the cam screw to prevent intermittent contact between the cam screw and the microprocessor.

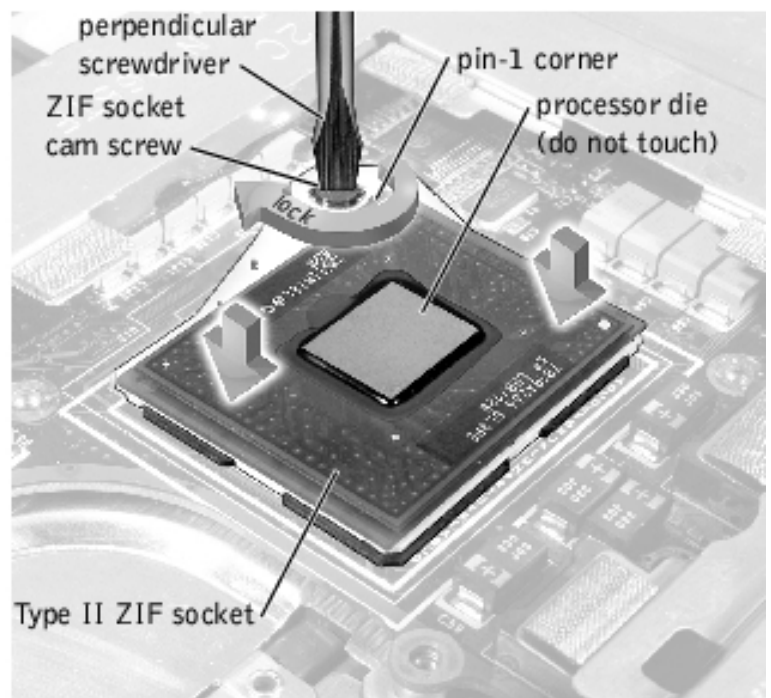
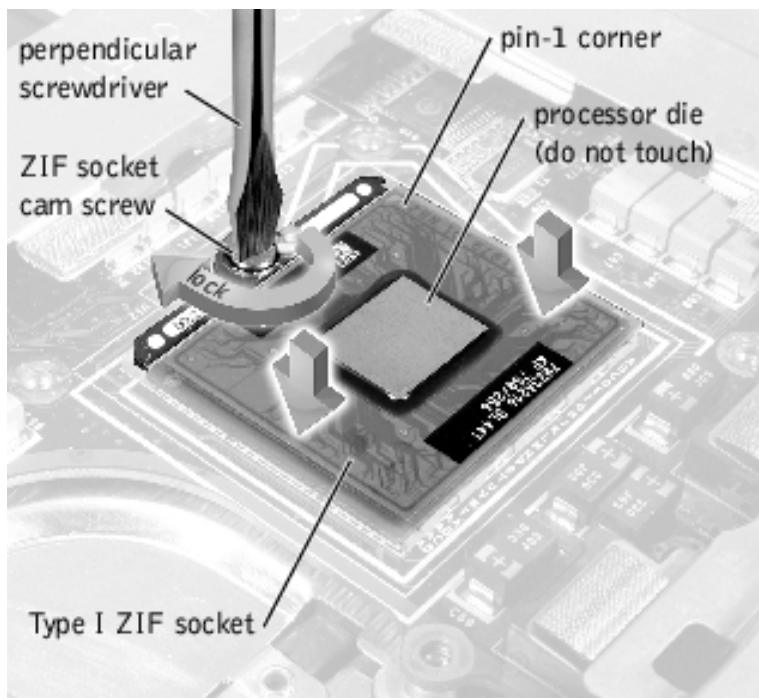

- ➔ **NOTICE:** Disconnect the computer and any attached devices from electrical outlets, and remove any installed batteries.
- ➔ **NOTICE:** To avoid ESD, ground yourself by using a wrist grounding strap or by touching an unpainted metal surface on the computer.
- ➔ **NOTICE:** Read "[Preparing to Work Inside the Computer](#)" before performing the following procedure.

1. Remove the [hard drive assembly](#).
2. Turn the computer over and remove the [keyboard](#).

- ➔ **NOTICE:** To ensure maximum cooling for the microprocessor, do not touch the heat transfer areas on the thermal cooling assembly. The oils in your skin reduce the heat transfer capability of the thermal pads.

3. Remove the [thermal cooling assembly](#).

- ➔ **NOTICE:** When removing the microprocessor module, pull the module straight up. Be careful not to bend the pins on the microprocessor module.

4. Remove the microprocessor module:

- ➔ **NOTICE:** To avoid damaging the microprocessor while removing the cam screw, hold the screwdriver so that it is perpendicular to the microprocessor.

- a. Use a small flat-head screwdriver and rotate the ZIF socket cam screw 180 degrees to loosen the ZIF socket.

The ZIF socket cam screw secures the microprocessor assembly to the system board assembly. Take note of the arrow on the ZIF socket cam screw points to the front of the computer when engaged.

- b. Use a microprocessor extraction tool to remove the microprocessor module.

Replacing the Microprocessor Module



HINT: To update or reflash the BIOS, see the *Dell Portable Computer BIOS Update Guide* for instructions.



NOTICE: After replacing the microprocessor module, update the BIOS using a flash BIOS update program floppy disk or CD.



NOTICE: Seating the microprocessor module properly in the ZIF socket does not require force.



NOTICE: A microprocessor module that is not properly seated can result in an intermittent connection or permanent damage to the microprocessor and ZIF socket.

1. Align the pin-1 corner of the microprocessor module with the pin-1 corner of the microprocessor socket on the system board and insert the microprocessor module.



NOTICE: You must position the microprocessor module correctly in the ZIF socket to avoid permanent damage to the module and the socket.

When the microprocessor module is correctly seated, all four corners are aligned to the same height. If one or more corners of the module are higher than the others, the module is not seated correctly.



NOTICE: Hold the microprocessor down while turning the cam screw to prevent intermittent contact between the cam screw and microprocessor.

2. Tighten the ZIF socket cam screw to secure the microprocessor module to the system board assembly.

Reserve Battery

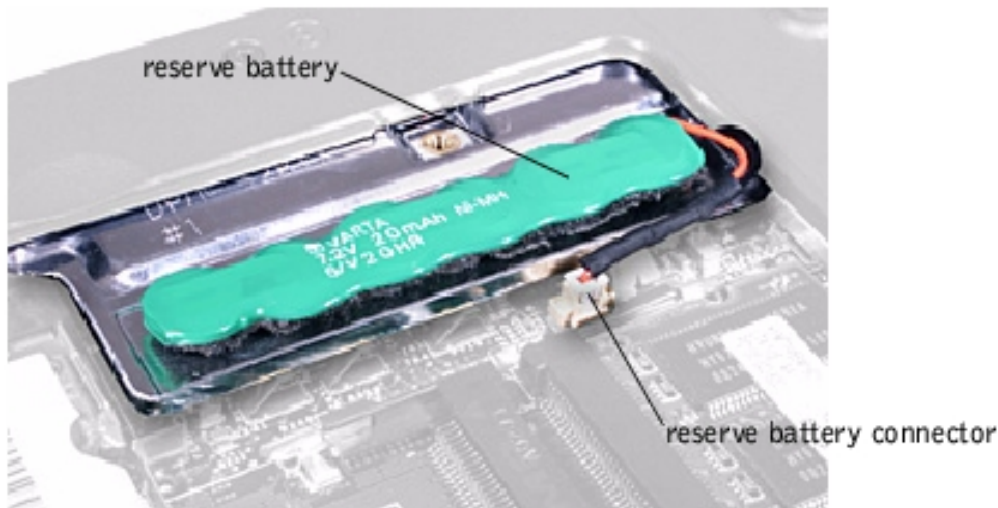

➡ **NOTICE:** The reserve battery provides power to the computer's RTC and NVRAM when the computer is turned off. Removing the battery causes the computer to lose the date and time information as well as all user-specified parameters in the BIOS. If possible, make a copy of this information before you remove the reserve battery.

📎 **HINT:** To update or reflash the BIOS, see the *Dell Portable Computer BIOS Update Guide* for instructions.

Removing the Reserve Battery

➡ **NOTICE:** Disconnect the computer and any attached devices from electrical outlets, and remove any installed batteries.

➡ **NOTICE:** To avoid ESD, ground yourself by using a wrist grounding strap or by touching an unpainted metal surface on the computer.

➡ **NOTICE:** Read "[Preparing to Work Inside the Computer](#)" before performing the following procedure.

1. Remove the [hard drive assembly](#).
2. Remove the [memory module cover](#).
3. Disconnect the reserve battery cable from the connector on the system board assembly located next to the reserve battery.
4. Remove the reserve battery from the EMI shield:
 - a. Pry the reserve battery free from the foam pad.
 - b. Remove the remnants of the foam pad from the EMI shield.

Replacing the Reserve Battery

1. Connect the reserve battery cable to the connector on the system board.
2. Position the reserve battery on the EMI shield next to the connector to minimize slack in the cable.

System Speaker Assembly

The system speakers are located on the front left and right sides of the bottom case assembly. Each speaker assembly is marked with a right and left label. Take note of the speaker cable routing in the bottom case assembly so that you can replace it correctly.



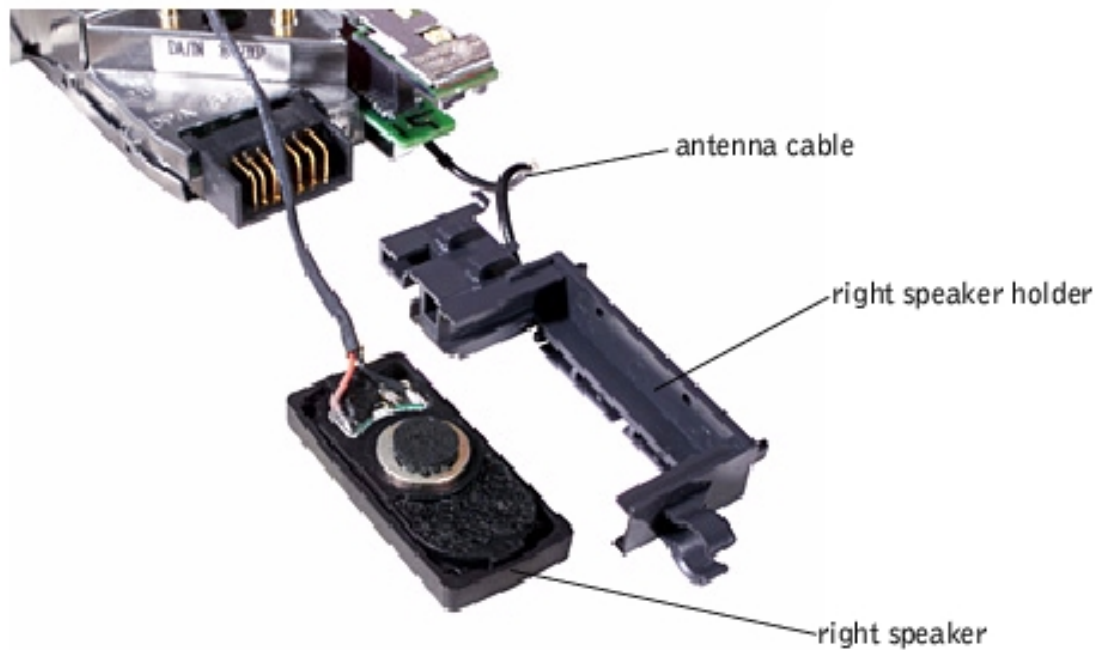
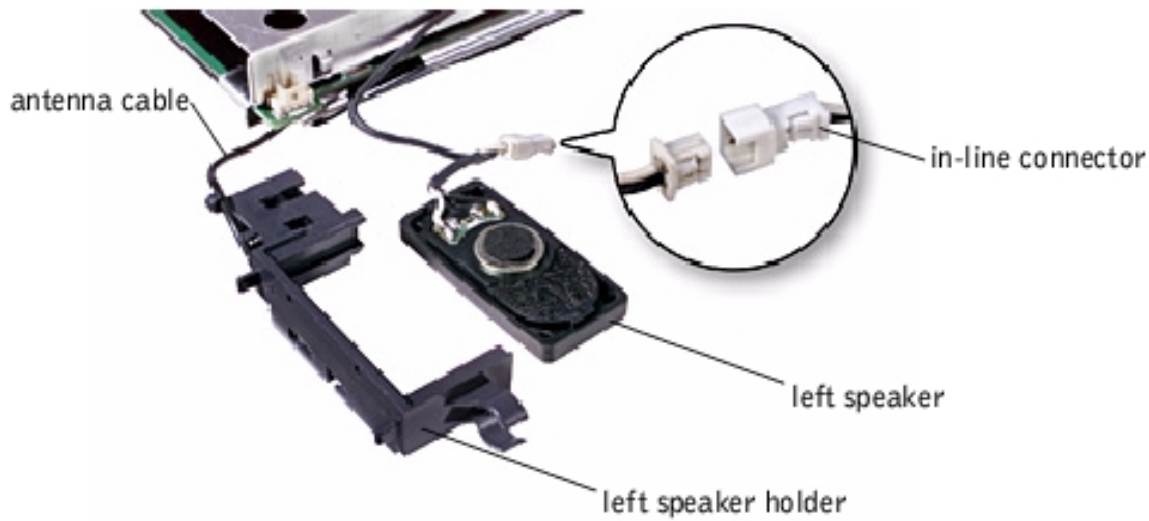

Removing the Speaker Assembly

- ➔ **NOTICE:** Disconnect the computer and any attached devices from electrical outlets, and remove any installed batteries.
- ➔ **NOTICE:** To avoid ESD, ground yourself by touching an unpainted metal surface or by using a wrist grounding strap.
- ➔ **NOTICE:** Read "[Preparing to Work Inside the Computer](#)" before performing the following procedure.



1. Remove the [hard drive assembly](#).
2. Remove the [keyboard assembly](#).
3. Turn the computer over and remove the [display assembly](#).
4. Remove the [palm rest assembly](#).
5. Remove the [thermal cooling assembly](#).
6. Disconnect the speaker interface cable connectors.

 **HINT:** The left speaker has an in-line connector, and its cable is shorter than the right speaker.

 **HINT:** Speakers face out in the bottom case assembly holders.

7. Remove the speaker assemblies by pulling them straight up and out of the bottom case assembly.

Replacing the Speaker Assembly

1. To replace the speaker assembly, place the mounting ring over the front palm rest screw post.
2. Slide the speaker assembly down into the bottom case assembly.

System Board Assembly

The system board's BIOS chip contains the system service tag number, which is also visible on a bar-code label on the bottom of the computer. The replacement kit for the system board assembly includes a floppy disk that provides a utility for transferring the service tag number to the replacement system board assembly.

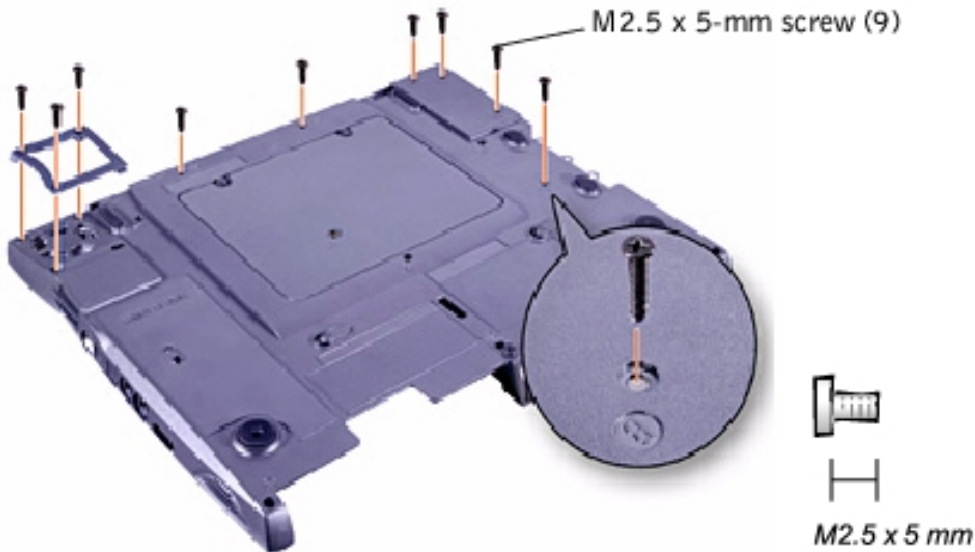

Removing the System Board

- ➔ **NOTICE:** Disconnect the computer and any attached devices from electrical outlets, and remove any installed batteries.
- ➔ **NOTICE:** To avoid ESD, ground yourself by using a wrist grounding strap or by periodically touching an unpainted metal surface on the computer.
- ➔ **NOTICE:** Read "[Preparing to Work Inside the Computer](#)" before performing the following procedure.

1. Remove the [hard drive assembly](#).
2. Turn the computer over and remove the [keyboard assembly](#).
3. Remove the [display assembly](#).

4. Remove the [palm rest assembly](#).
5. Verify that all PC Cards or plastic blanks are removed from the PC Card slot.
6. Verify that the PC Card ejectors do not extend from the PC Card slot.
7. Turn the computer upside down, and remove the nine M2.5 x 5-mm screws labeled with a "circle B" that secure the system board assembly to the bottom case assembly:
 - a. Remove the three M2.5 x 5-mm screws that secure the thermal cooling fan protective cover to the bottom case assembly. The thermal cooling fan protective cover is located at the back on the right side of the bottom case assembly.
 - b. Remove the remaining six M2.5 x 5-mm screws from the bottom case assembly.

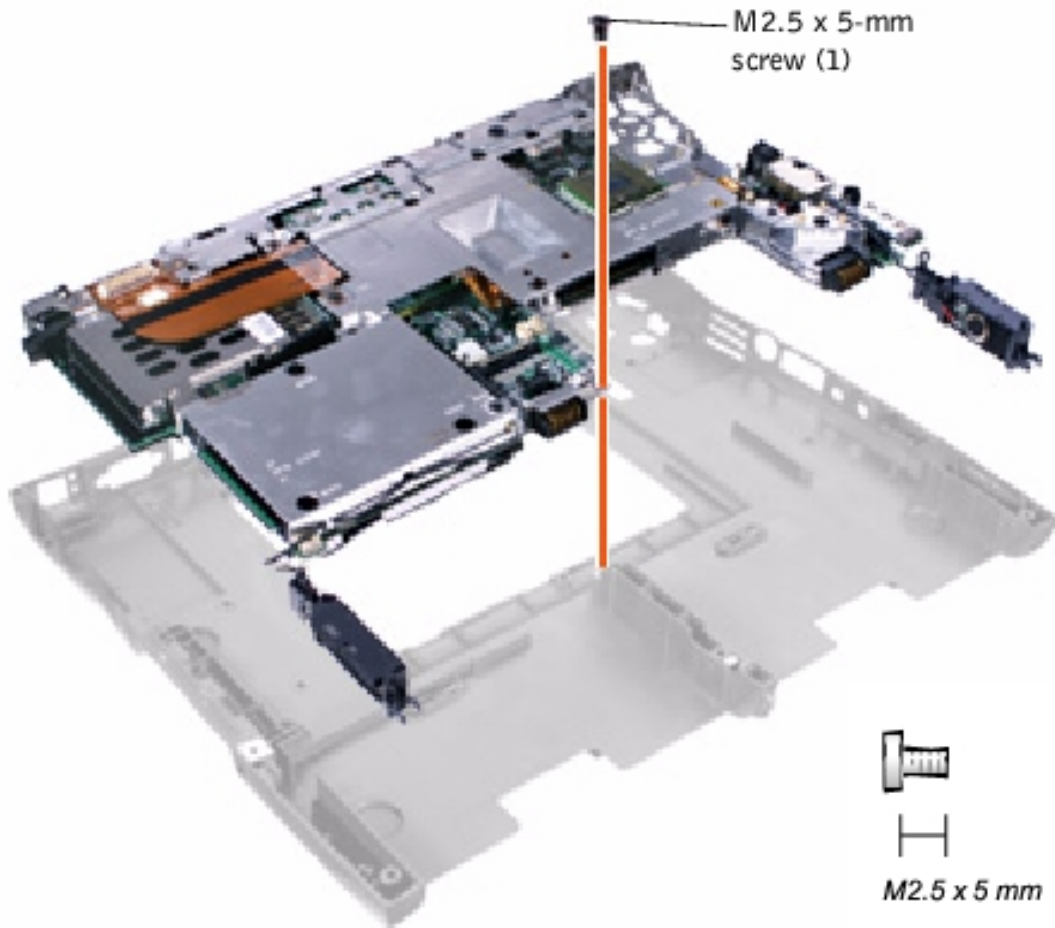

8. Turn the bottom case assembly right-side up and remove the M2.5 x 5- mm screw labeled with a white circle on the front center of the system board.
9. Remove the [speakers](#) from the bottom case assembly.
10. Pull the right side of the bottom case assembly, next to the external headphone and microphone connectors, away from the system board assembly as you simultaneously lift the front of the system board assembly out and away from the bottom case assembly.

Replacing the System Board

1. Install the microprocessor on the replacement system board.

2. Connect the right and left speaker to the replacement system board.
3. Install the replacement system board:
 - a. Insert the external microphone and headphone connectors through the plastic bottom case assembly.
 - b. Replace the nine M2.5 x 5-mm screws, starting on the right side of the bottom case assembly.
 - c. Replace the thermal cooling fan protective cover, inserting the tab into the bottom case assembly and replacing the three M2 x 4-mm screws. If you replace the screw opposite the tab first, the other two screws are easier to insert and replace.



HINT: Be sure to route cables so that they will not be crimped or pinched when the complete assembly is put back together.

4. Replace any subassemblies that you may have removed, including the memory modules, PCI card cage, Mini PCI card, speaker modules, thermal cooling assembly, and hybrid cooling fan.
5. Replace the palm rest assembly, the display assembly, the hard drive, and the keyboard assembly.
6. Replace the modular bay devices and any PC Cards or plastic blanks in the PC Card slot.



HINT: After replacing the system board assembly, be sure to enter the system's service tag number into the BIOS of the replacement system board assembly.

7. Insert the floppy disk or CD that accompanied the replacement system board assembly into the appropriate drive, and turn on the computer. Follow the instructions on the display screen.

Module Latch Assemblies

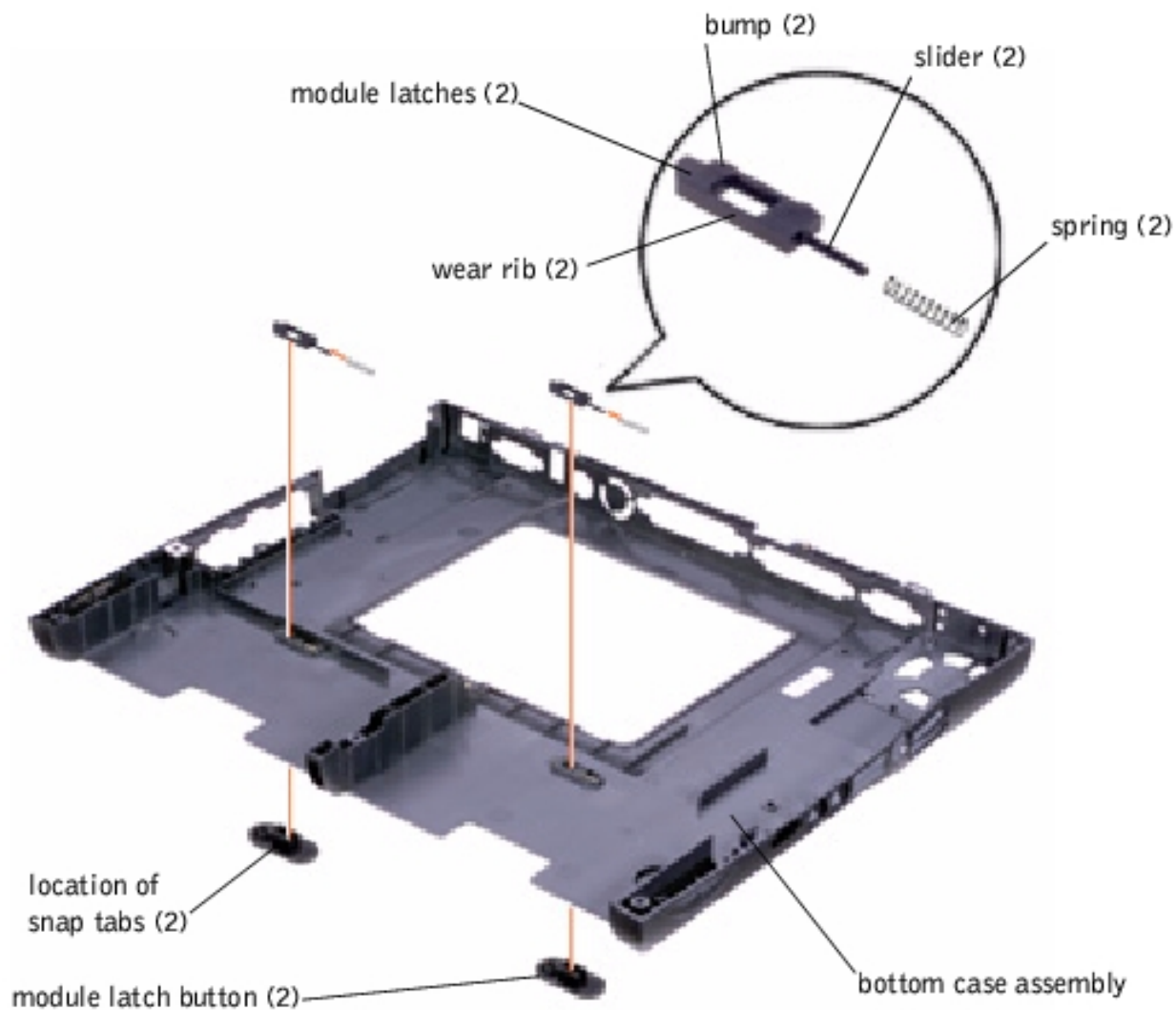

Removing the Module Latch Assemblies

- **NOTICE:** Disconnect the computer and any attached devices from electrical outlets, and remove any installed batteries.
- **NOTICE:** To avoid ESD, ground yourself by using a wrist grounding strap or by touching an unpainted metal surface on the computer.
- **NOTICE:** Read "[Preparing to Work Inside the Computer](#)" before performing the following procedure.

1. Remove the [hard drive assembly](#).
2. Turn the computer over and remove the [keyboard assembly](#).
3. Remove the [display assembly](#).
4. Remove the [palm rest assembly](#).
5. Remove the left module latch button from the bottom case assembly by squeezing the snap tabs.

Apply pressure to the module latch and spring while unsnapping the snap tabs to prevent the module latch

assembly from coming loose from the case. If the module latch assembly does come loose from the case:

- a. Reinsert the spring onto the slider on the module latch, and reinstall the module latch into the holding features on the inside of the case.



HINT: The latch will not function properly if the slider is oriented incorrectly.

- b. Ensure that the slider is inserted in its respective hole, that the side of the latch with the two bumps is facing the back of the case, and that the surface with the wear ribs is facing the bottom of the case.
6. Snap in the new latch button from the bottom of the base, making certain its snap tabs are fully engaged in the module latch.
 7. Ensure that the newly installed latch moves smoothly and freely when pushed and released.
 8. Repeat steps 5 through 7 for the latch on the right side.
-

[Back to Contents Page](#)