



Power Macintosh G3
All-In-One





Basics

Power Macintosh G3

All-In-One





[movie.studio](#)

Overview

Introducing the Power Macintosh G3 All-In-One design.

- The new all-in-one is designed for education and fulfills all the computing needs of teachers and students.
- Powerful and easy-to-use video editing and multimedia authoring features at an affordable price.

Click the icon at left for a QuickTime VR movie of the Power Mac G3 All-In-One.



**Features of the Power Macintosh G3 All-In-One include**

- PowerPC G3 microprocessor running at 233 MHz or 266 MHz
- RAM expandable to 384 MB in 3 DIMM slots using 64-bit wide, 168-pin JEDEC-standard 3.3 V unbuffered SDRAM DIMMs
- 512K of static RAM used as L2 cache on processor module
- Built-in 2D and 3D hardware graphics acceleration
- PERCH slot to support I/O card
- One modem slot on the I/O card for optional fax/modem card
- 4 GB or 6 GB ATA hard drive
- 100 MB SCSI Iomega Zip drive
- CD-ROM ATAPI drive at 24X speed
- 1.4 MB SuperDrive
- One SCSI port
- Two GeoPort serial ports
- 10BASE-T Ethernet port





- One ADB port
- Three PCI expansion slots to accept
 - three 7-inch PCI cards, or
 - three 15 W cards, or
 - two 25 W cards, or
 - one 15 W card and one 25 W card
- Fan speed thermally controlled
- Energy Saver control panel
- 2 MB video RAM expandable to 6 MB with 3.3 V, 100 MHz or faster SGRAM on a 144-pin small outline dual inline memory module (SO-DIMM)





Optional Build-to-Order Power Mac All-In-One Features:

- 100 MB SCSI Iomega Zip drive in the expansion bay
- 6 GB hard drive
- 64 MB (using one 64 MB DIMM) or 96 MB (using 1x 32 MB and 1x64 MB DIMM) of memory
- I/O, Audio/Video card
- 10/100 BaseT ethernet card





The Cuda Chip

The Cuda is a microcontroller chip. Its function is to

- Turn system power on and off
- Manage system resets from various commands
- Maintain parameter RAM (PRAM)
- Manage the Apple Desktop Bus (ADB)
- Manage the real-time clock

Many system problems can be resolved by resetting the Cuda chip (see Symptom Charts for examples). Press the Cuda reset button on the logic board to reset the Cuda chip. (See “Logic Board Diagram” later in this chapter to locate the Cuda reset button.) If you continue to experience system problems, refer to “Resetting the Logic Board” in this Basics chapter.





Resetting the Logic Board

Resetting the logic board can resolve many system problems (refer to “Symptom Charts” for examples). Whenever you have a unit that fails to power up, you should follow this procedure before replacing any modules.

- 1 Unplug the computer.
- 2 Remove the battery from the logic board.
- 3 Disconnect the power supply cable from the logic board and then press the Cuda Reset button. (See “Logic Board Diagram” later in this chapter to locate the Cuda Reset button.)
- 4 Wait at least 10 minutes before replacing the battery.
- 5 Make sure the battery is installed in the correct +/- direction.





6 Reassemble the computer and test the unit.

Note: This procedure resets the computer's PRAM. Be sure to check the computer's time/date and other system parameter settings afterwards.





Sound

The sound system for the Power Macintosh G3 computers is implemented entirely on the I/O card. Each supports 16-bit stereo sound output and input, available simultaneously.

The sound circuitry on the I/O card and system software can create sounds digitally and either play the sounds through speakers inside the enclosure or send the sound signals out through the sound output jacks. The sound circuitry digitizes and records sound as 16-bit samples. The computer can use 22.050K or 44.100K samples per second. The sound system plays samples at the sampling rate specified in the Monitors & Sound control panel.





The Power Macintosh G3 also records sound from several sources:

- A microphone connected to the line-level sound input jack
- A compact disc in the CD-ROM player
- Analog sound from the cross-platform card in a PCI slot
- Analog sound from optional communication cards
- Internal Microphone

With each sound input source, sound playthrough can be enabled or disabled.





Sound Output

All sound output features for the Power Macintosh G3 computer are provided by the I/O card. The I/O card provides one mini jack for sound output on the back of the enclosure.

The output jacks are connected to the sound amplifier. The mini jack is intended for connecting a pair of headphones or amplified external speakers. There are two speakers and two headphone jacks on the front of the system. Inserting a plug into the sound output mini jack disconnects the internal speaker.





Sound Input

The I/O card provides a stereo sound input jack on the back of the enclosure for connecting an external Apple PlainTalk line-level microphone or other sound source pair of line-level signals. The sound input jack accepts a standard 1/8-inch stereophonic phone plug (two signals plus ground).

Note: The microphone for the Macintosh LC and LC II does not work with the I/O cards.

Options in the Monitors & Sound control panel determine the interaction between the sound input and output devices. The sound circuitry normally operates in one of three modes:

- Sound playback—computer-generated sound is sent to the speaker and the sound output jacks.
- Sound playback with playthrough—computer sound and sound input are mixed and sent to the speakers and sound output jacks.





- Sound record with playthrough—input sound is recorded and also sent to the speakers and sound output jacks.





PowerPC G3 and Backside Cache

Backside cache is a significant architectural design change from earlier PowerPC processors. The main advantage of the backside cache architecture is the speed of the dedicated CPU-to-L2 cache interface. Using the dedicated bus allows the CPU to access the fast L2 cache storage through a high speed bus without addressing the slower system bus or competing with other devices attached to the system bus. In comparison, a “far-side” cache running on the system bus would limit that SRAM interface to 50MHz.

The PowerPC G3 microprocessor interfaces with SRAM storage via a dedicated bus running at various multiples of the core PLL CPU speed. With high speed L2 SRAM and a dedicated L2 bus, the CPU can access stored information up to the speed of the processor clock. L2 access is determined by the clock ratio setting. For example, with a 250MHz





PowerPC G3, and a 2.5 L2 bus ratio, the backside cache bus speed will be 100MHz, twice the speed of the system bus.

SDRAM DIMMs

Three DRAM expansion slots on the logic board accept 3.3 V SDRAM unbuffered 8-byte DIMMs. The 168-pin DIMM has a 64-bit-wide data bus per bank. The minimum bank size supported on the Power Macintosh G3 all-in-one model is 4 MB, and the largest is 64 MB. The largest DIMM supported is a two-bank DIMM of 64 MB using 32 Mbit SDRAM devices.

The Power Macintosh G3 All-In-One logic board supports a maximum DRAM expansion of 384 MB. Fill all three slots with 128 MB DIMMs.





The DRAM DIMMs can be installed one or more at a time. The logic board supports only linear memory organization. Therefore, no performance gains are seen when two DIMMs of the same size are installed. Any supported size DIMM can be installed in any DIMM slot, and the combined memory of all the DIMMs installed will be configured as a contiguous array of memory.

Important: Power Macintosh G3 computers use SDRAM DIMMs. DIMMs from older Macintosh computers are not compatible and should not be used even though they fit into the DRAM DIMM slots.





SGRAM Video Memory

The Power Macintosh G3 logic board comes with 2 MB of Synchronous Graphic RAM (SGRAM) video memory soldered on. The logic board also contains a video memory expansion slot that accepts a Small Outline DIMM (SO-DIMM) to increase video memory up to a maximum of 6 MB. Apple supports a 4 MB SGRAM SO-DIMM that is 32-bit wide, 144-pin, fast-paged, 100 MHz/10 ns cycle time or faster.

Important: Use only SGRAM SO-DIMMs. Never use the 256K or 512K video memory DIMMs used in older Macintosh computers.





DIMM Slots

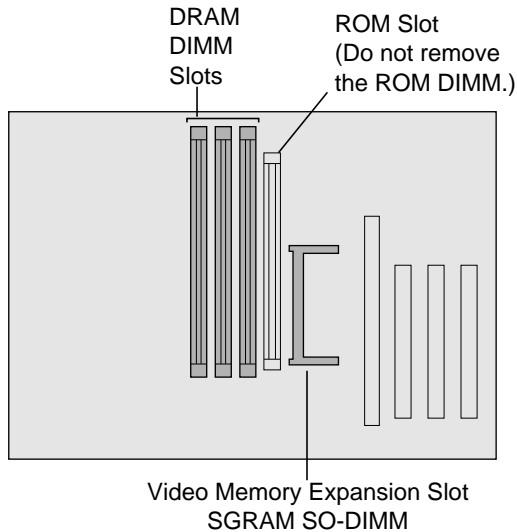



Peripheral Component Interconnect (PCI)

The Peripheral component Interconnect (PCI) expansion slots accept 7-inch PCI cards. Install only expansion cards that come with Macintosh drivers and are compliant with the PCI 2.1 standard. Nubus™ cards cannot be used in these expansion slots.

PCI offers significantly higher performance than the NuBus architecture used in previous Macintosh models. Running at 33 MHz, the PCI bus is up to three times faster than NuBus, offering overall enhanced system performance, particularly in the areas of video and networking.





Internal Locator

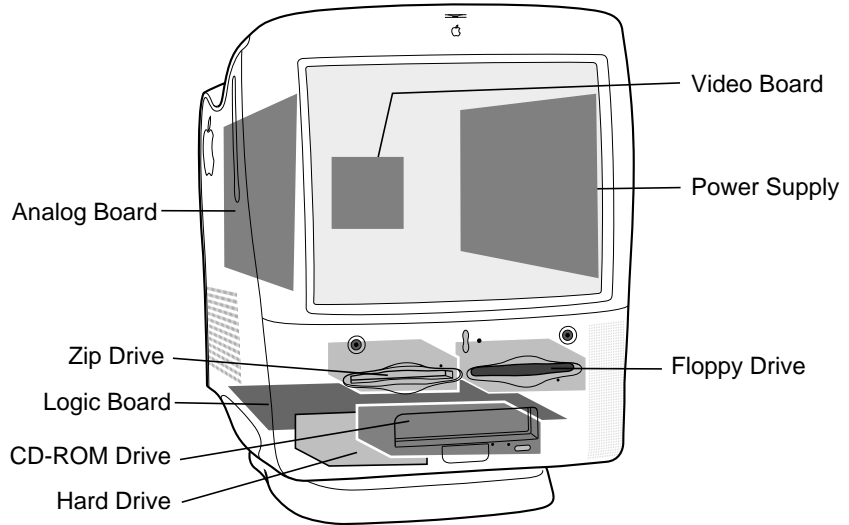



Rear View

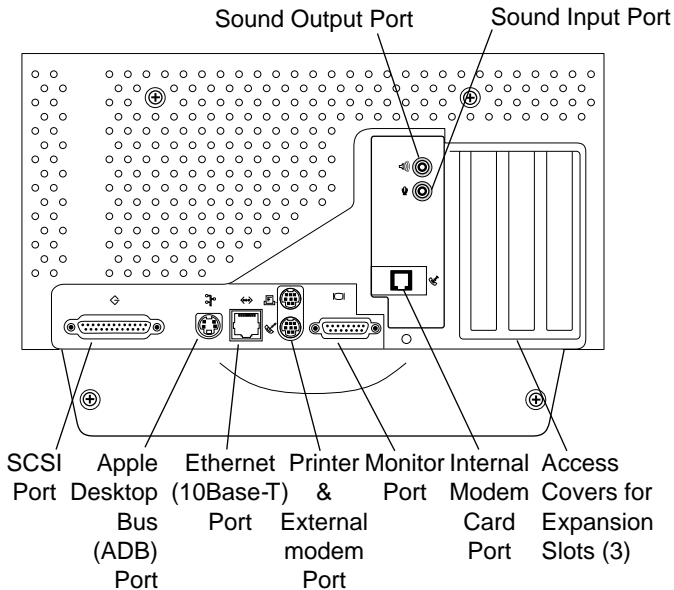

See next page for optional AV card.





Optional AV Card

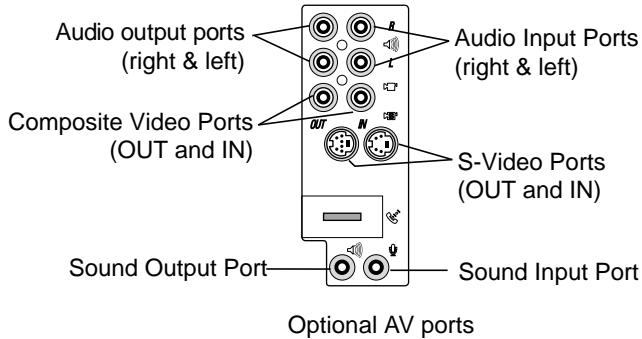



Logic Board

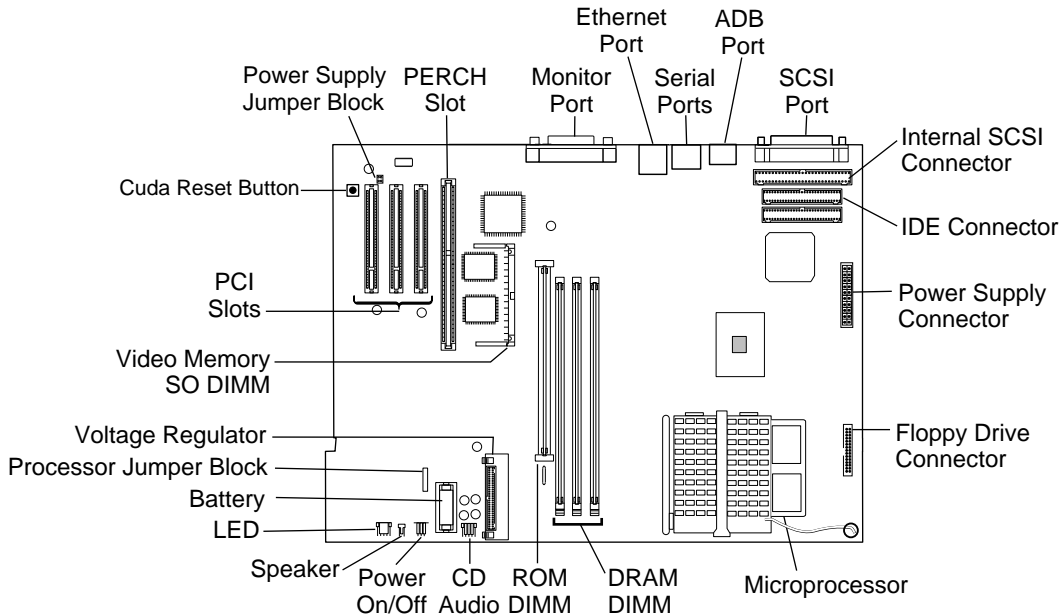



Repair Strategy

Service the Power Macintosh G3 computers through module exchange and parts replacement. Customers can request on-site service from an Apple Authorized Service Provider Plus (AASP+), Apple Assurance (US only), or Apple Canada Technical Answerline (Canada only). They can also choose carry-in service from an AASP.

Ordering

Apple Service Providers planning to support the computer systems covered in this manual may purchase Service modules and parts to develop servicing capability. To order parts, use the AppleOrder (US only) or ARIS (Canada only) system and refer to the Power Macintosh G3 “Service Price Pages.”





Large businesses, universities, and K-12 accounts must provide a purchase order on all transactions, including orders placed through the AppleOrder (US only) or ARIS (Canada only) system.

USA Ordering

US Service providers not enrolled in AppleOrder may fax their orders to Service Provider Support (512-908-8125) or mail them to

Apple Computer, Inc.
Service Provider Support
MS 212-SPS
Austin, TX 78714-9125

For US inquiries, please call Service Provider Support at 800-919-2775 and select option #1.





Canadian Ordering

Canadian Service providers not enrolled in ARIS may fax their orders to Service Provider Support in Canada (1-800-903-5284). For Canadian inquiries, please call Service Provider Support at 905-513-5782 and select option #3.





Warranty/AppleCare/ARIS

US Only

The Power Macintosh G3 computers are covered under the Apple One-Year Limited Warranty. The AppleCare Service Plan is also available for these products. Service Providers are reimbursed for warranty and AppleCare repairs made to these computers. For pricing information, refer to “Service Price Pages.”

Canada Only

The Power Macintosh G3 computers are covered under AppleCare. The Extended AppleCare Service Plan is also available for these products. Service Providers are reimbursed for warranty and AppleCare repairs made to these computers. For pricing information, refer to “Service Price Pages.”





Specifications

Power Macintosh G3 All-in-One





Introduction

Specifications information for this product can be found in the Spec Database, which you can access at Service Source Online (<http://service.info.apple.com>) or on Service Source CD.

Spec Database at Service Source Online

From the Service Source Online home page, click Troubleshoot and Repair to access the main repair procedures page. Then click either Apple Spec in the navigation table in the upper right corner of the page, or click Apple Spec Database from the list of reference tools below.

Spec Database on Service Source CD

Open the CD and double-click the Apple Spec Database alias located at the top level of the CD.





Take Apart

Power Macintosh G3
All-In-One





Chassis Carrier

No preliminary steps are required before you begin this procedure.

- 1 Loosen the four screws.
- 2 Pull the chassis carrier half way out of the unit.

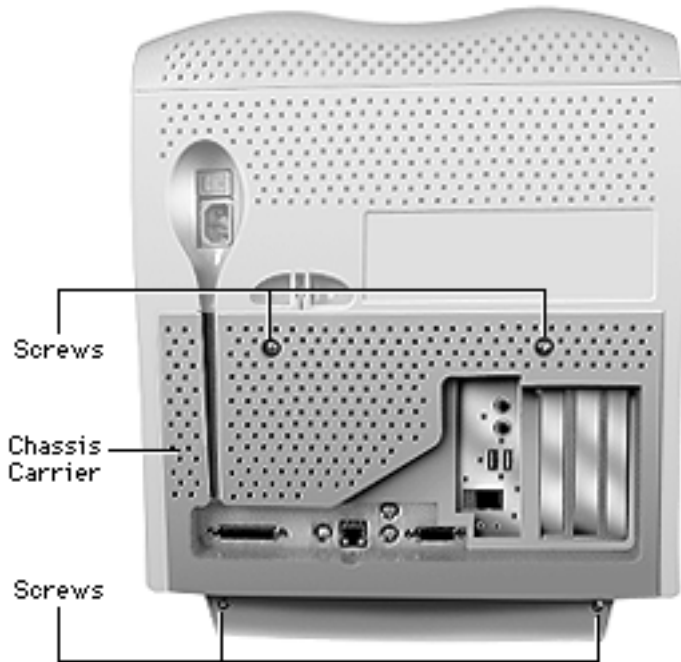

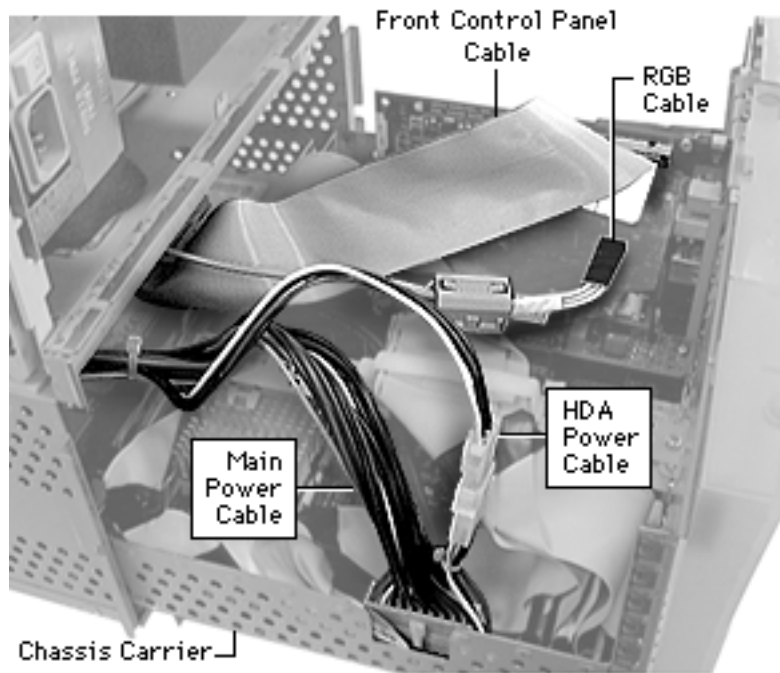

- 3 Disconnect the front control panel cable, RGB cable, main power cable, and HDA power cable.



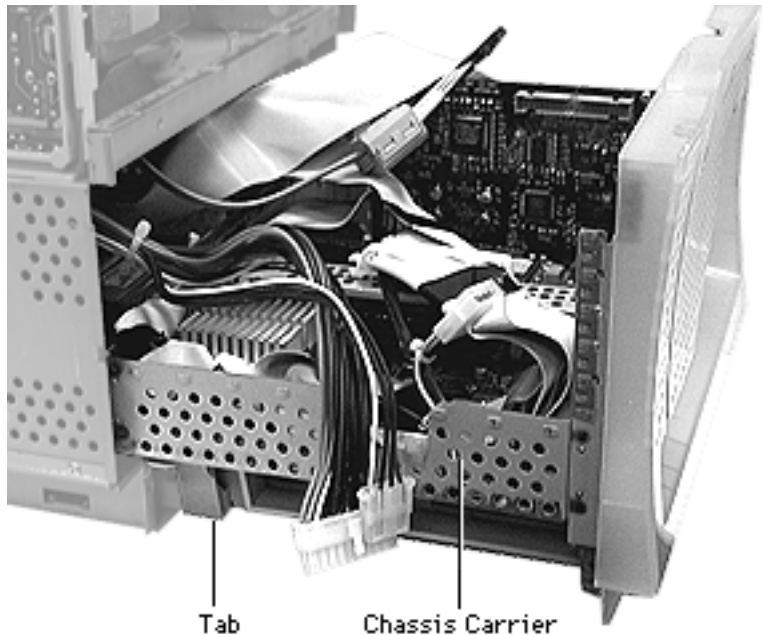

- 4 Press up on the tabs to release the chassis carrier.
- 5 Pull chassis carrier out of unit.

Note: See graphic on next page showing complete chassis carrier out of the unit.



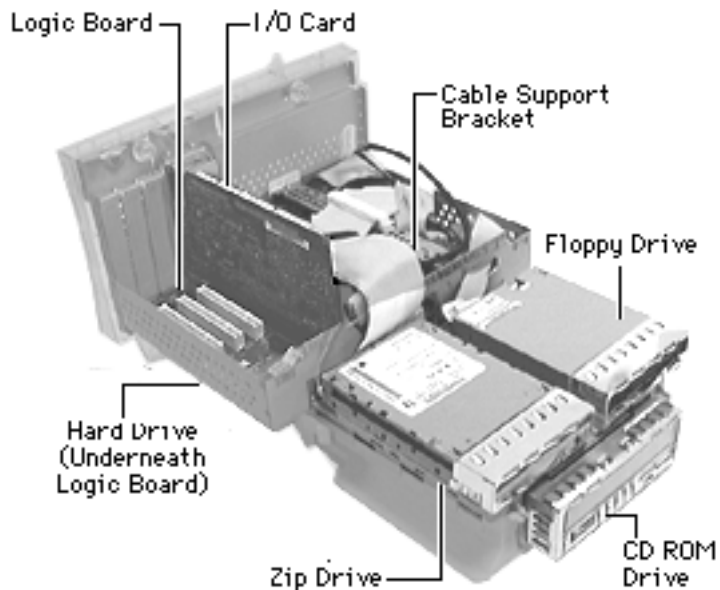

Note: Graphic illustrates modules and support bracket located in chassis carrier.





Hard Drive

Before you begin, remove the chassis carrier.

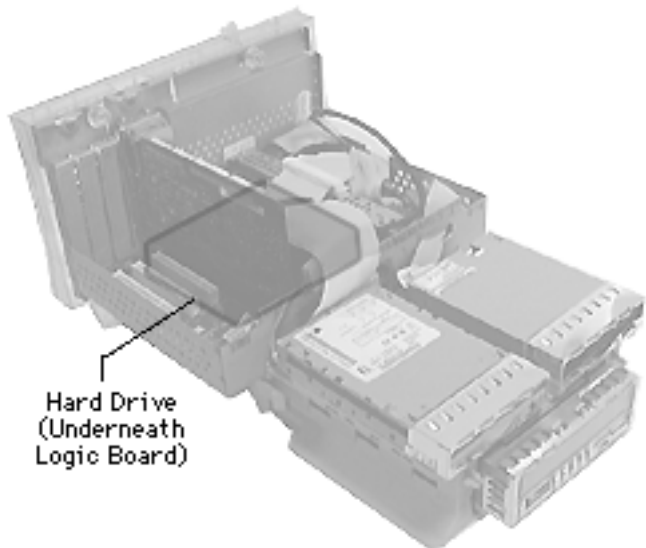



- 1 Disconnect the hard drive data cable and the power cable from the back of the hard drive.

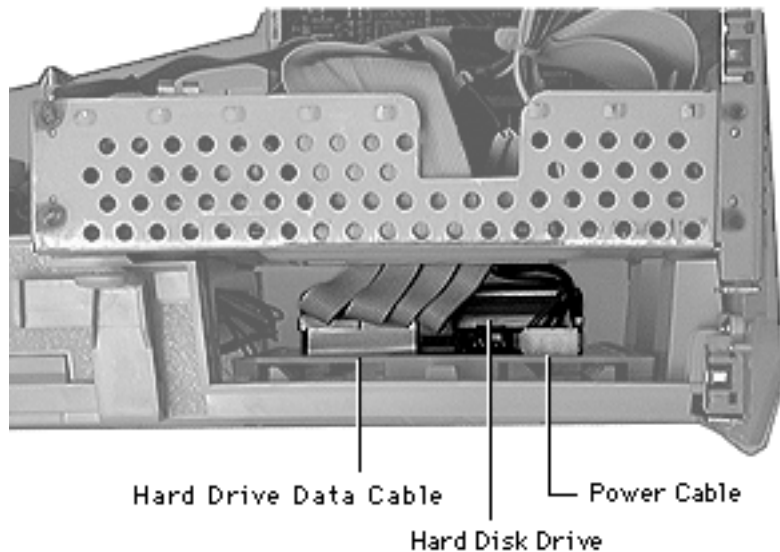

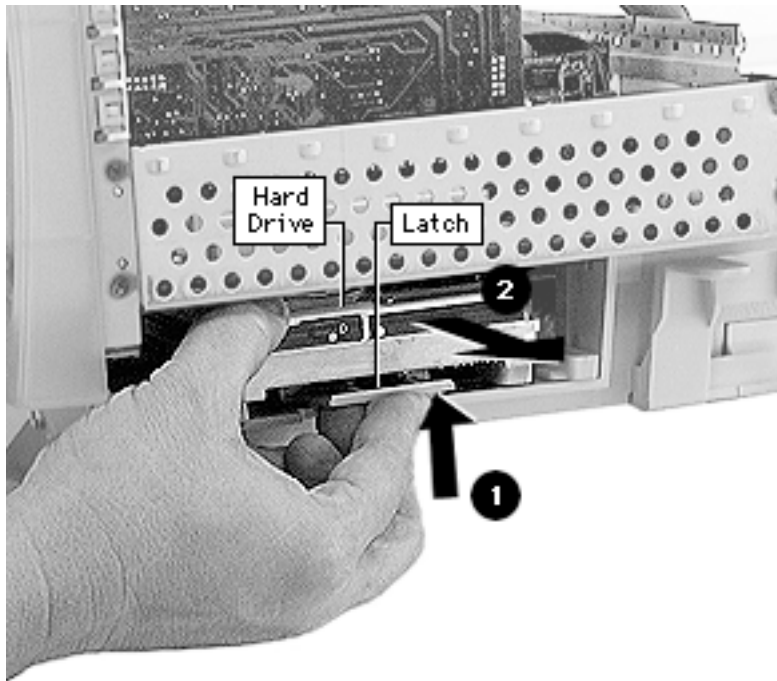

- 2 Pull up the release latch and slide the hard drive forward to remove it from the internal chassis.

Note: Be sure to remove the hard drive from its carrier before returning the drive to Apple.





Floppy Drive

Before you begin, remove the chassis carrier.

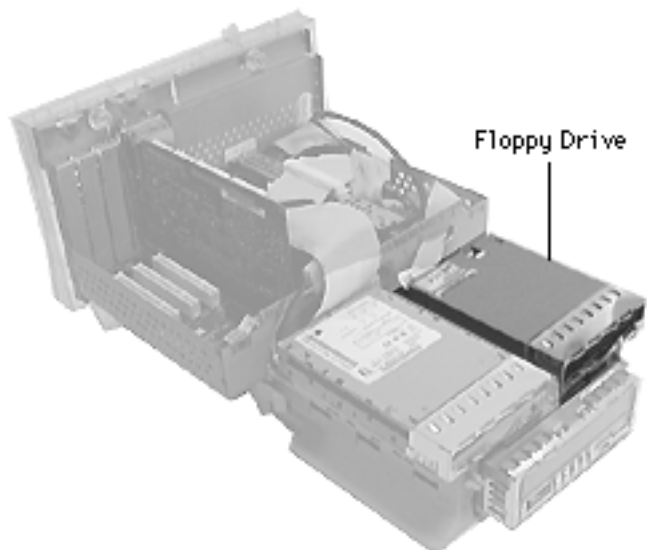

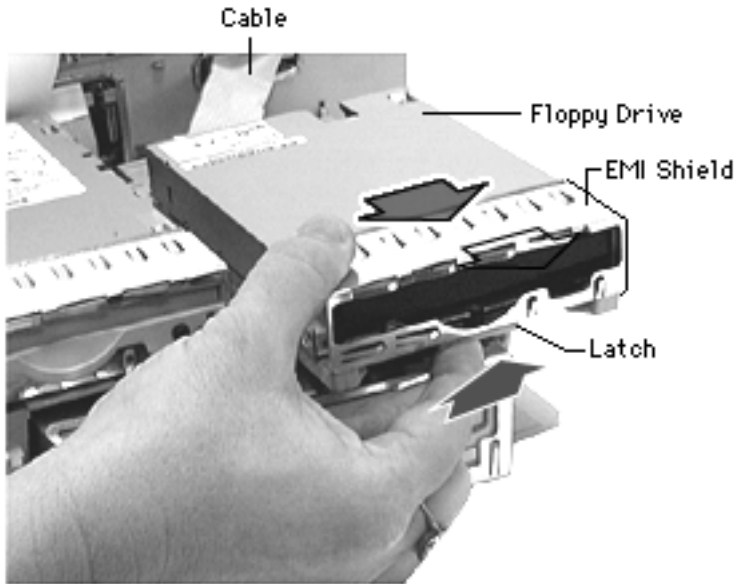

- 1 Pull up the release latch, and slide the floppy drive forward enough to reach the floppy cable.
- 2 Disconnect the cable from the back of the floppy drive.
- 3 Remove the floppy drive from the unit.

Note: Be sure to remove the EMI shield and floppy drive carrier before returning the drive to Apple.





Zip Drive

Before you begin, remove the chassis carrier.

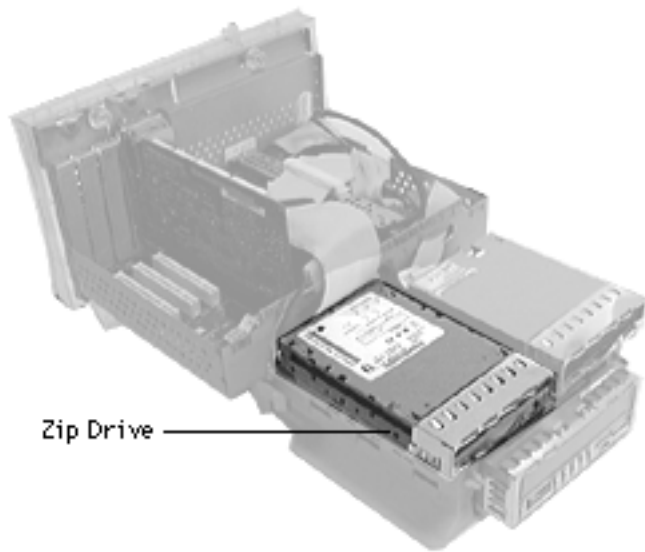

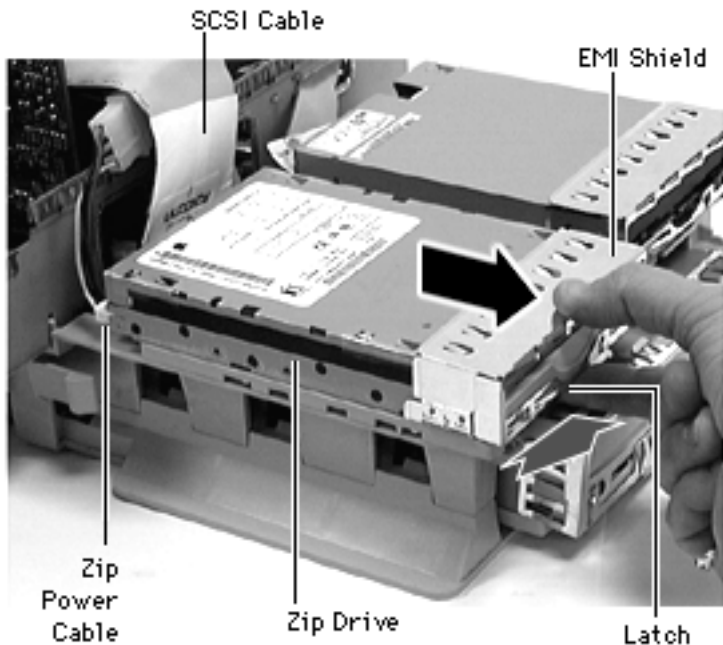

- 1 Pull up the release latch, and slide the Zip drive forward enough to reach the cables.
- 2 Disconnect the SCSI and Zip power cables from the back of the Zip drive.
- 3 Remove the Zip drive from the unit.

Note: Be sure to remove the EMI shield and Zip drive carrier before returning the drive to Apple.





Adding a Zip Drive

There may be requests to add a zip drive to a Power Mac G3 All-in-one computer. Some prebuilt and build-to-order configurations do not include a zip drive. Therefore, customers may want to upgrade their systems by installing a zip drive taken from another computer, or by purchasing the individual service parts.

See the Additional Procedures section for instructions.





CD-ROM

Before you begin, remove the chassis carrier.

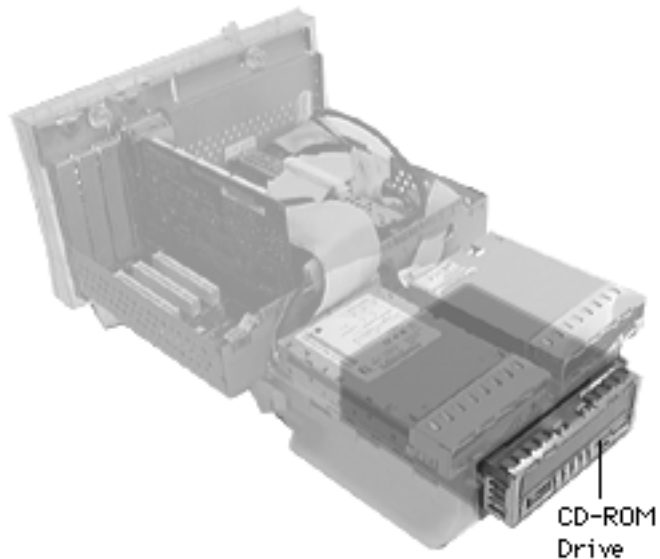

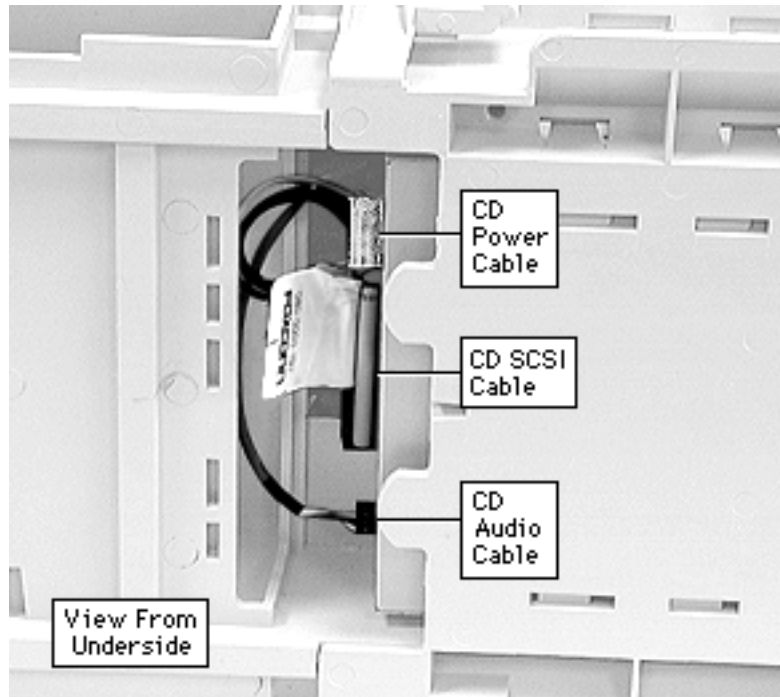

- 1 Position the chassis carrier on its side.
- 2 Disconnect the CD-ROM power cable, CD-ROM SCSI cable, and CD-ROM audio cable from the back of the CD-ROM drive.



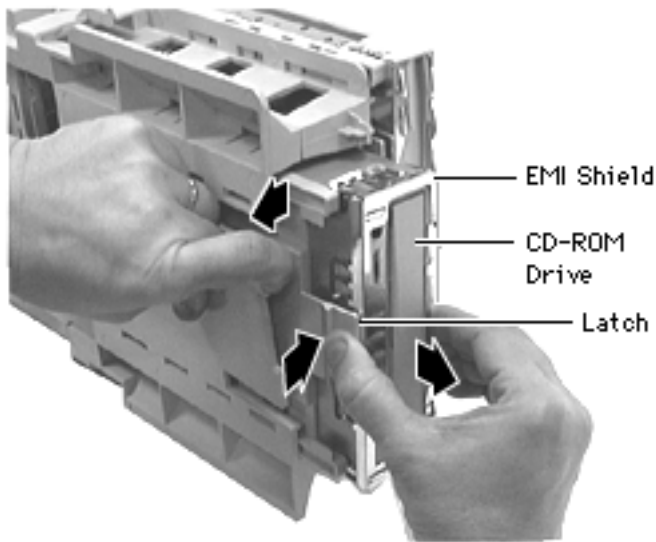

- 3 Pull down on the plastic frame while squeezing the latch. Slide the CD-ROM drive forward to remove it from the unit.

Note: Be sure to remove the EMI shield and CD-ROM carrier before returning the drive to Apple.



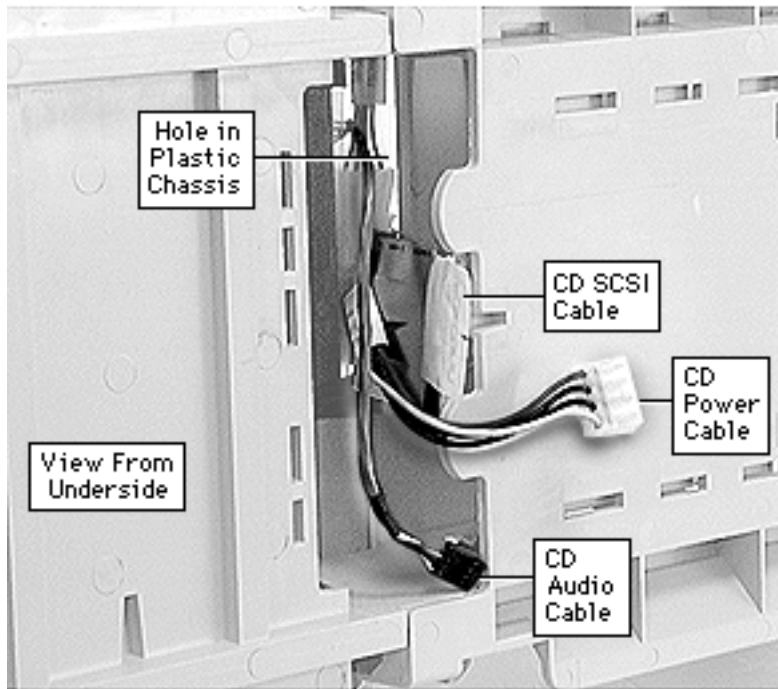

Replacement Note: If you removed the CD-ROM cables from the chassis you will need to reposition them before connecting the CD-ROM drive.

- 1 Tuck the CD-ROM power cable, the CD-ROM SCSI cable, and the CD-ROM audio cable through the hole in the plastic chassis.
- 2 Reconnect the cables to the CD-ROM drive.
- 3 Push CD-ROM into the chassis until it clicks into position.





I/O Card

Before you begin, remove the chassis carrier.

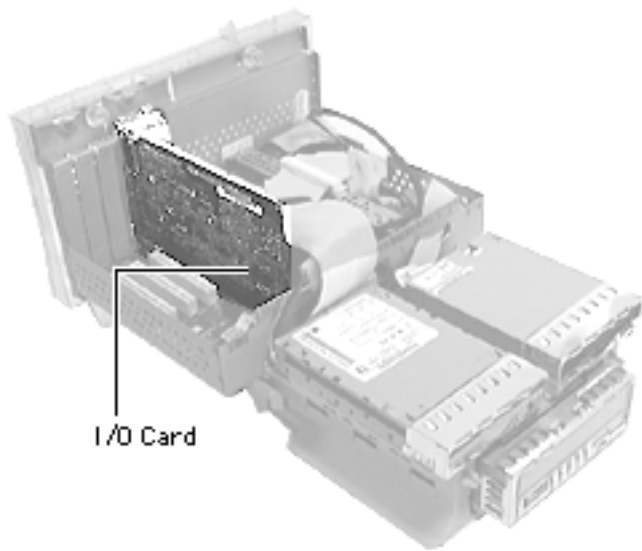

I/O Card



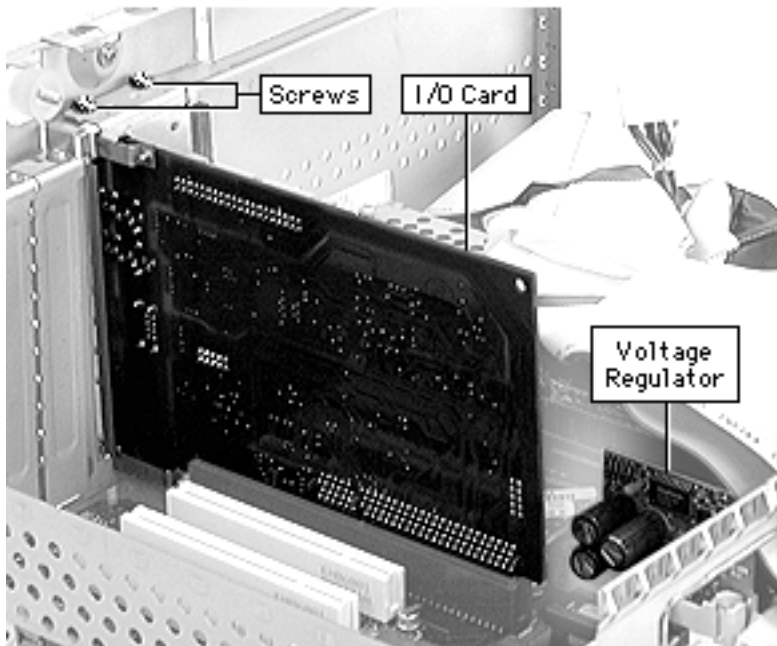

- 1 Disconnect cables on the I/O Card.
- 2 Remove two screws that secure card to chassis.

Note: Be careful of the voltage regulator when removing or replacing the I/O card.





- 3 Remove external I/O screw on chassis.

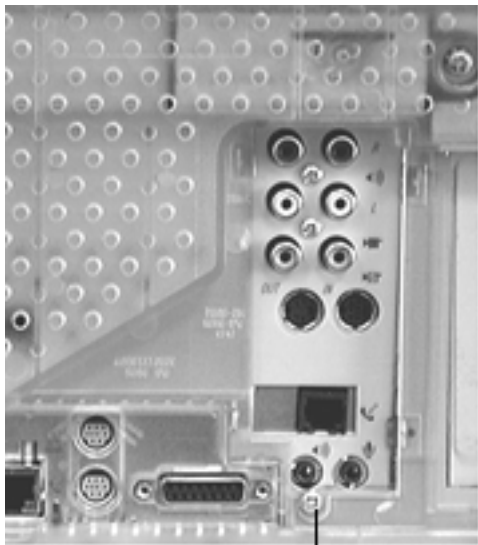

Screw



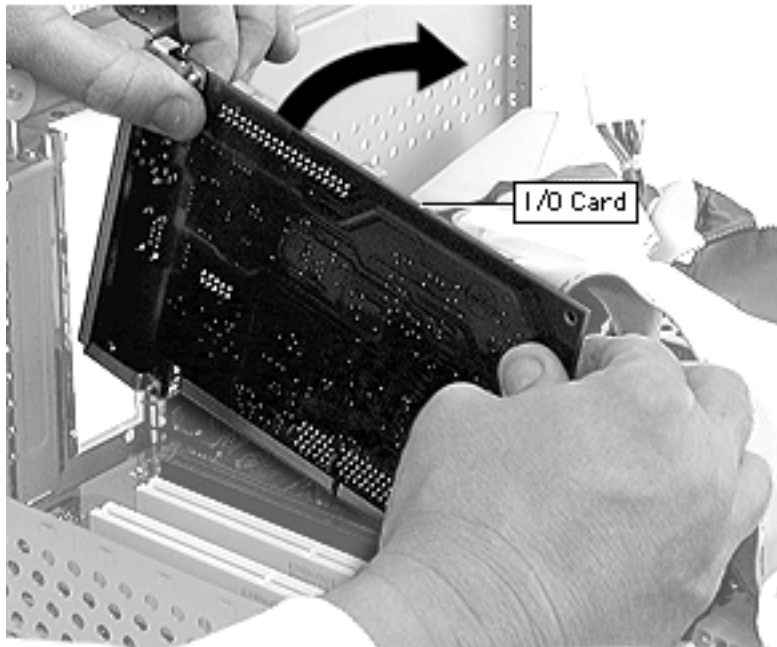

- 4 Gently rock the I/O card out of the socket.
- 5 Remove card from logic board.

Replacement Note: Line up back end (end nearest voltage regulator) of I/O card and push card down into slot. Be careful not to damage the voltage regulator or modem.





Cable Support Bracket

Before you begin remove the chassis carrier.

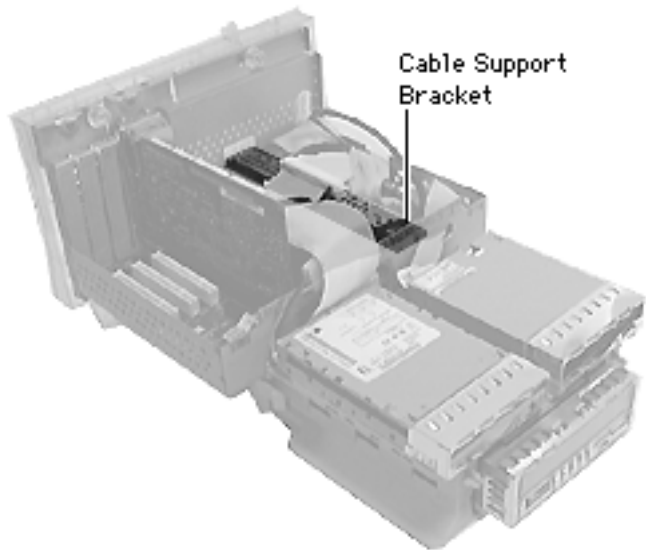



- 1 Disconnect the SCSI cable and the two IDE cables on the logic board.

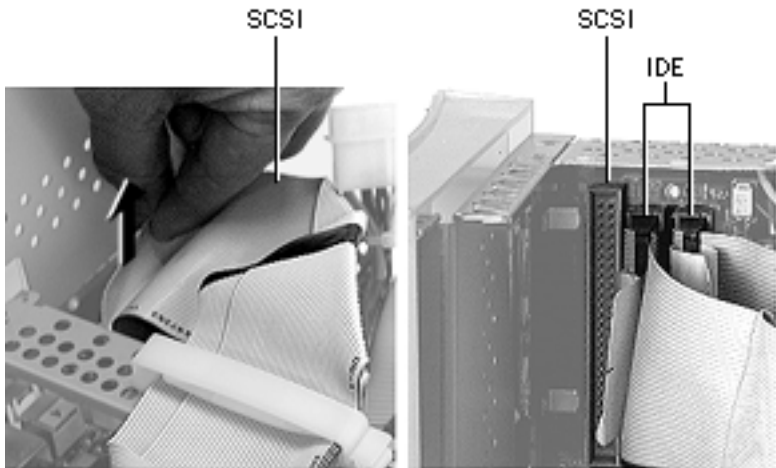

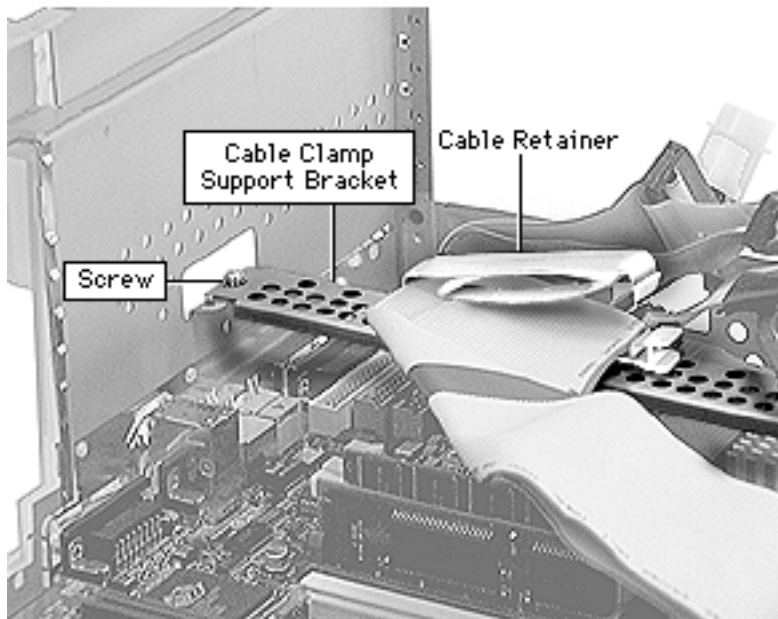

- 2 Remove screw on cable support bracket.
- 3 Open white plastic cable retainer and remove gray cables from the support bracket.
- 4 Lift the metal support bracket out of unit.



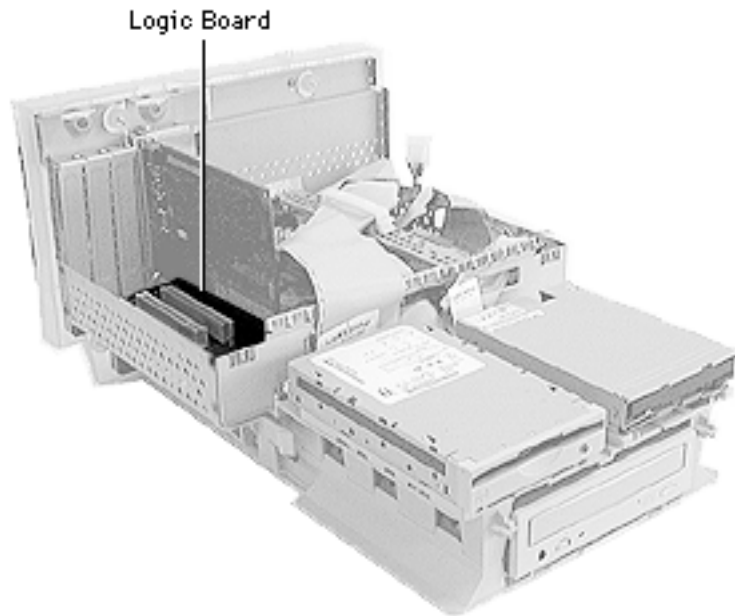

Logic Board

Before you begin do the following:

- Remove the chassis carrier
- Remove I/O card
- Disconnect the SCSI and IDE cables
- Remove cable clamp support bracket

Caution: Review the ESD precautions in Bulletins/ Safety.



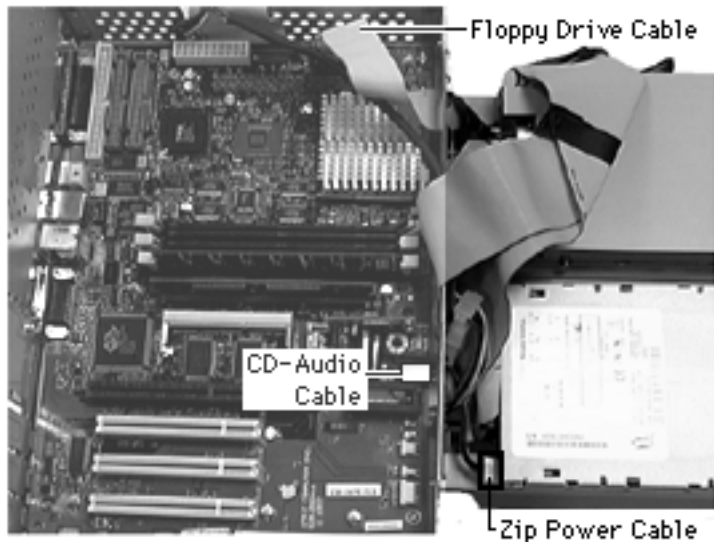

- 1 Disconnect the floppy drive cable.
- 2 Pull the Zip drive out a bit to disconnect the Zip drive power cable.
- 3 Disconnect the CD-Audio cable (located next to battery).



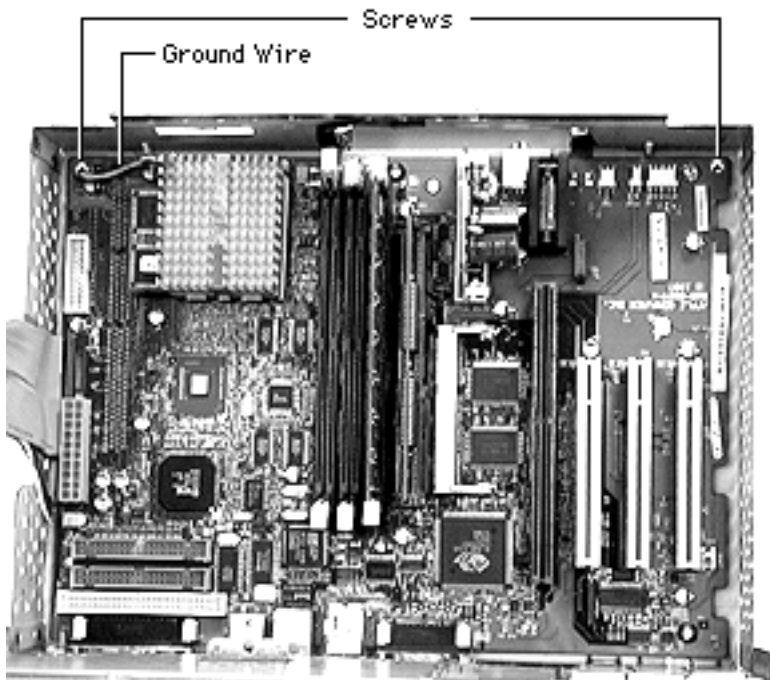

- 4 Remove the two silver screws.

Note: Do not remove ground wire from the heatsink.



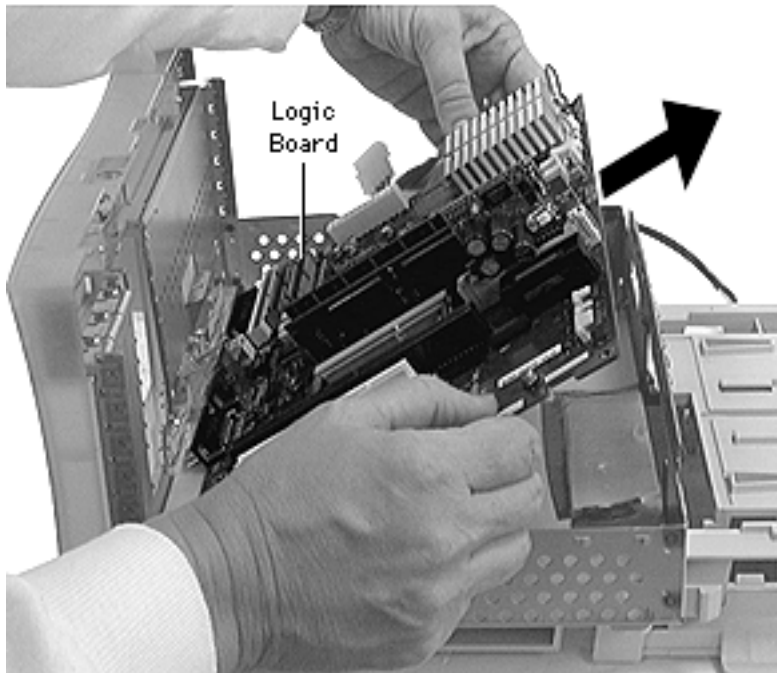

- 5 Gently lift the logic board out of the chassis carrier.

Replacement Note: This logic board requires that jumper J28 be set properly for the unit to function. The power supply jumper, which installs at J28, should cover the pins marked "Mac" when a new board is installed.





CRT EMI Shield

⚠ Warning: This product contains high voltage and a high-vacuum picture tube. To prevent serious injury, review CRT safety in Bulletins/Safety.

Before you begin, do the following:

- Remove the chassis carrier
- Remove the top, side, and rear panel housing

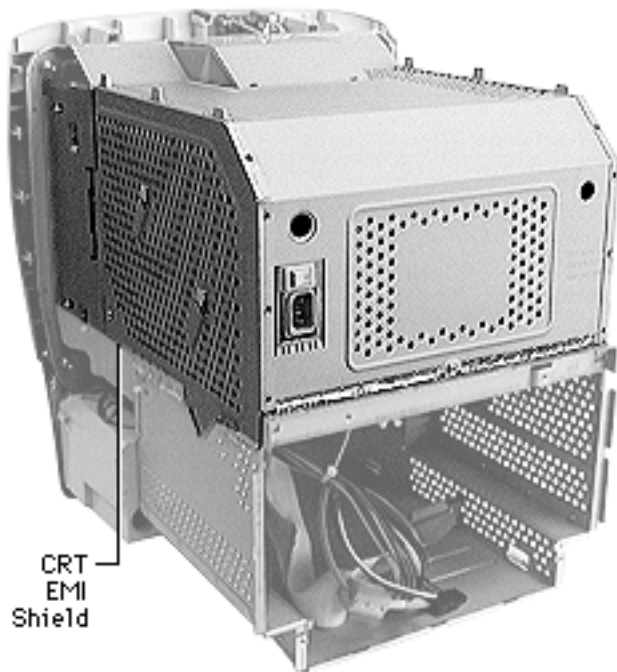

CRT
EMI
Shield



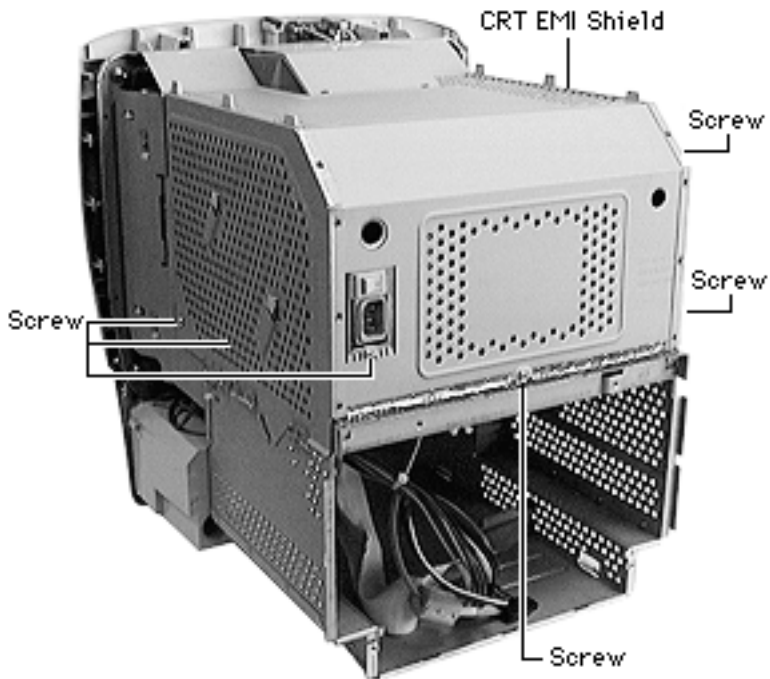

- 1 Remove the six screws on the EMI Shield.

Note: The EMI shield has sharp edges. Be careful not to cut yourself.



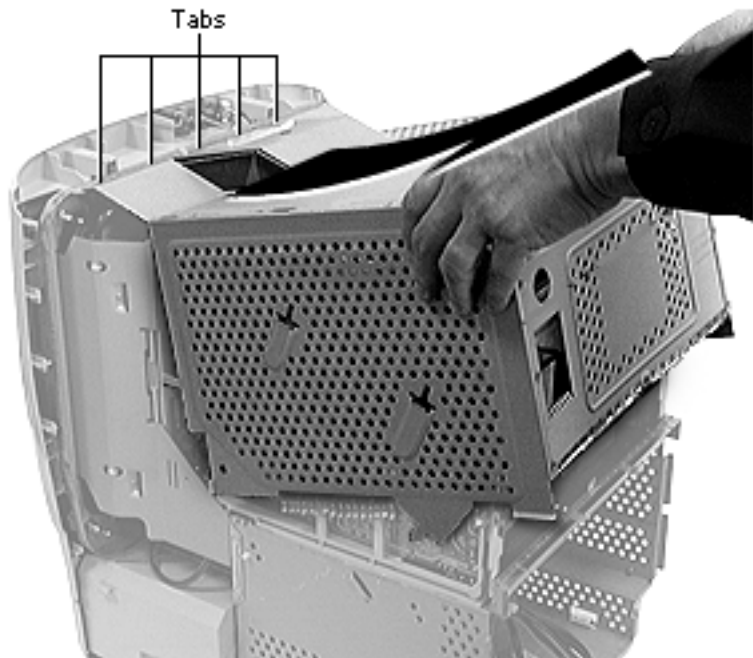

- 2 Lift the shield up, releasing the shield from the metal tabs on the chassis.
- 3 Remove the shield from the unit.

Replacement Note: Make sure the microphone cable is pulled through the CRT chassis frame so the EMI shield doesn't pinch the microphone cable.





Power Supply

Before you begin do the following:

- Remove the chassis carrier
- Remove the top, side, and rear panel housing
- Remove the CRT EMI shield
- Discharge the CRT

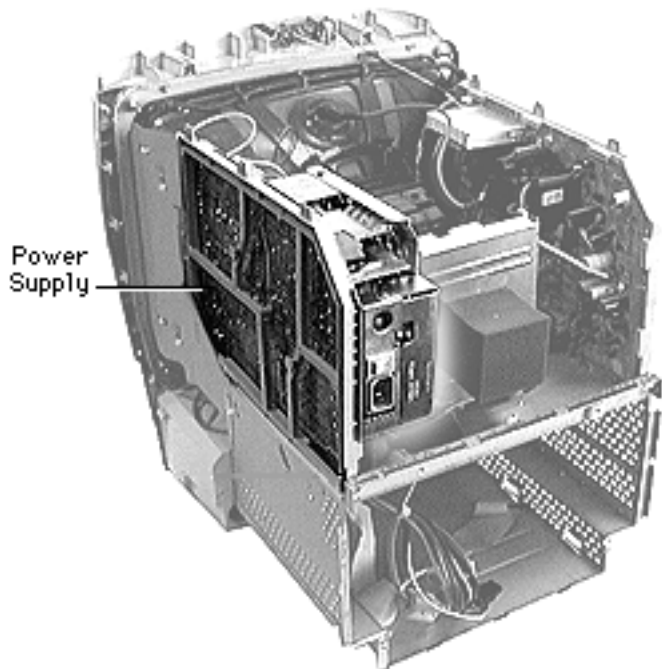

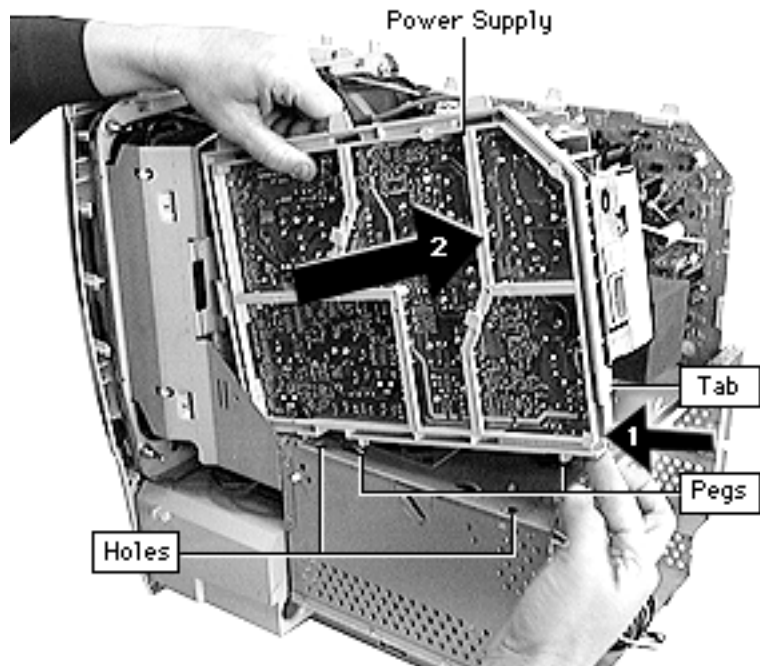

- 1 Push tab in.
- 2 Lift and pull the power supply up to clear the pegs from the chassis holes.

Note: The cables are still attached to the power supply at this point.



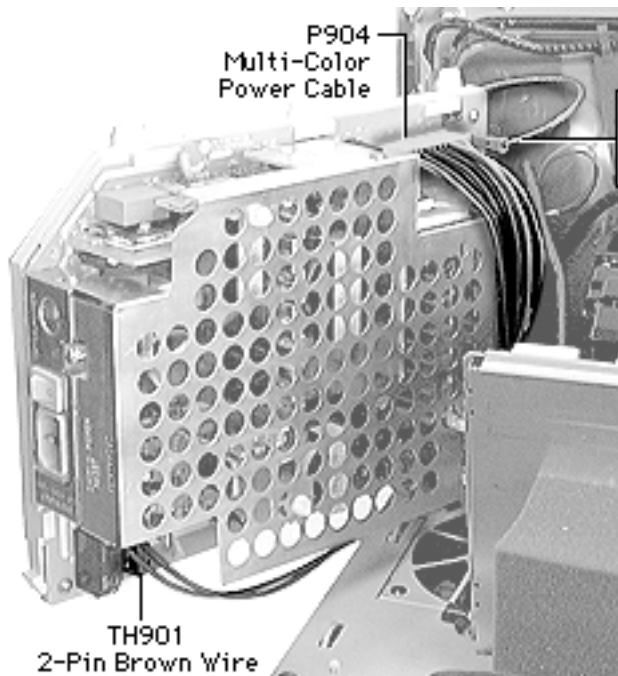

- 3 Disconnect the multi-colored power cable (P904), the ground wire (P911), and the 2-pin brown wire (TH901), from the power supply.



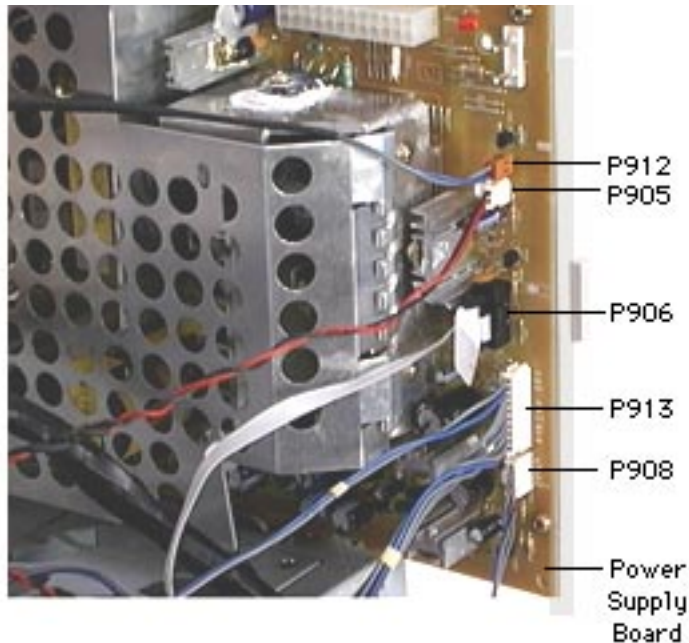

- 4 Tilting the power supply off to the side, disconnect the remaining cables on the power supply board:

- P912
- P905
- P906
- P913
- P908

Note: P906 and P908 have locking connectors. Pinch or squeeze to release the connectors.

- 5 Remove power supply from the chassis.



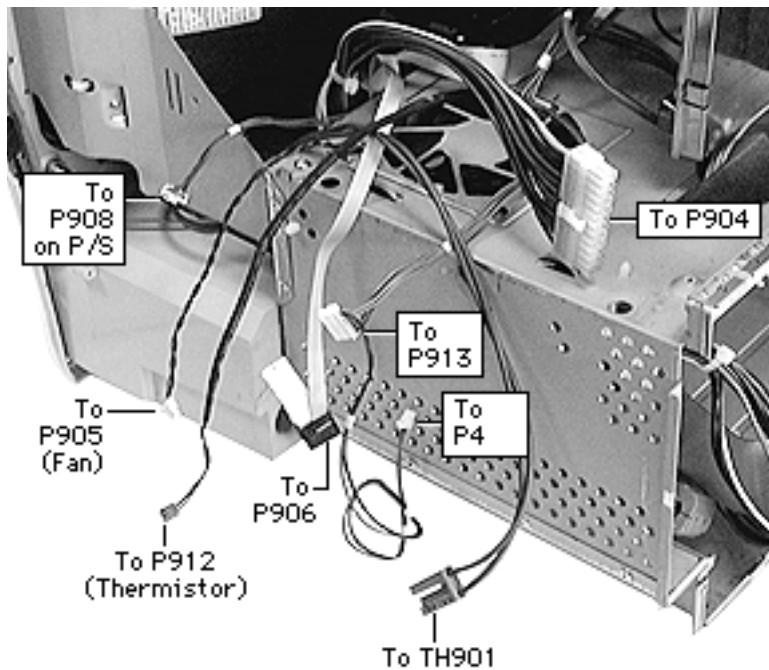

Replacement Note: Some connectors are impossible to reconnect when the board is in place. Before inserting the power supply, connect cables TH901, P908, P913, P906, and P905. Also, make sure the pegs on the power supply reset into the holes in the chassis.



**Additional cable descriptions:**

P912: Thermistor cable: a 2-wire gray & brown cable that connects to the brown connector on the power supply board

P905: Fan cable: a 2-wire red & black cable

P906: a flat gray ribbon cable (922-3492). This cable is a wide gray ribbon cable that connects to the I/O card and then splits off into three cables, one goes to the front panel board, one to the power supply board (P906), and one to the analog board (P503).

P913: a 10-wire gray & blue cable (2 wires from this cable split off and connect to P4 on the front panel board and the other end connects to P505 on the analog board)

P908: a 5-wire gray & blue cable (P908 connects to P507 on the analog board)



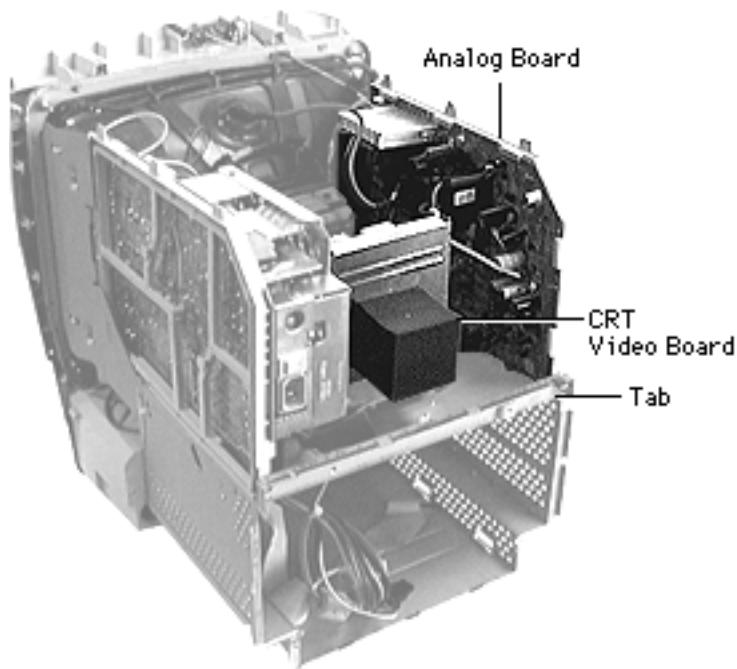

Analog/Video Board

Before you begin do the following:

- Remove the chassis carrier
- Remove the top, side, and rear housing
- Remove the CRT EMI shield
- Discharge the CRT
- Disconnect anode cap



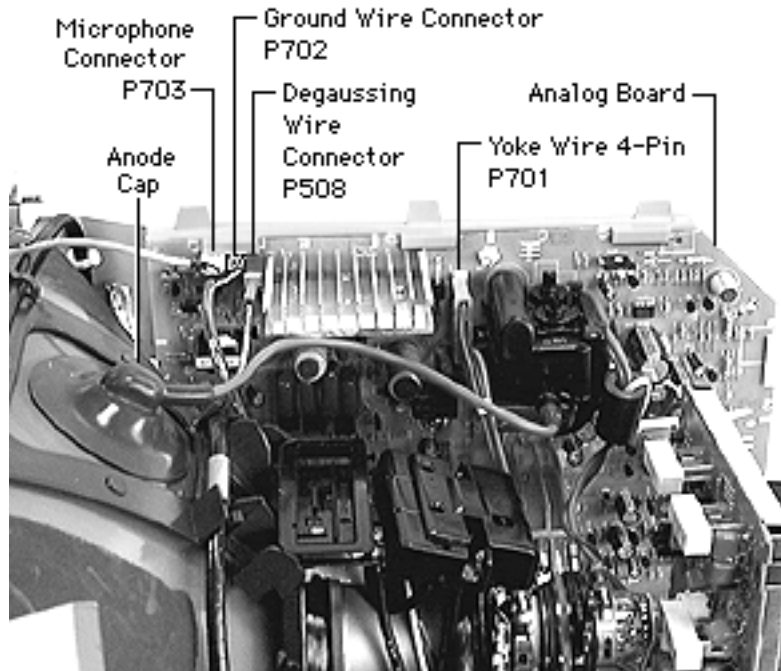

- 1 Disconnect the microphone (P703), ground wire (P702), degaussing wire (P508), and the yoke wire (P701).





CRT Video Board

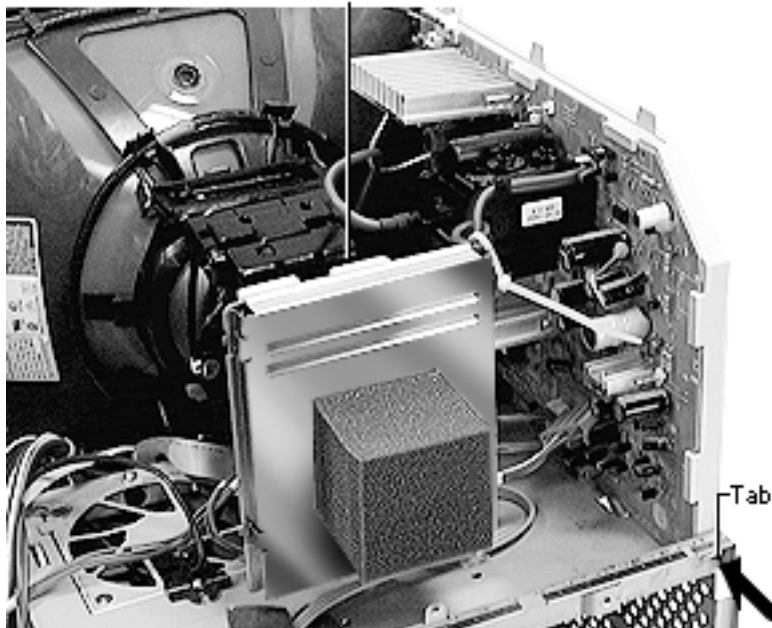

- 2 Gently remove the CRT video board.
- 3 Push in tab and lift analog board out of chassis holes.



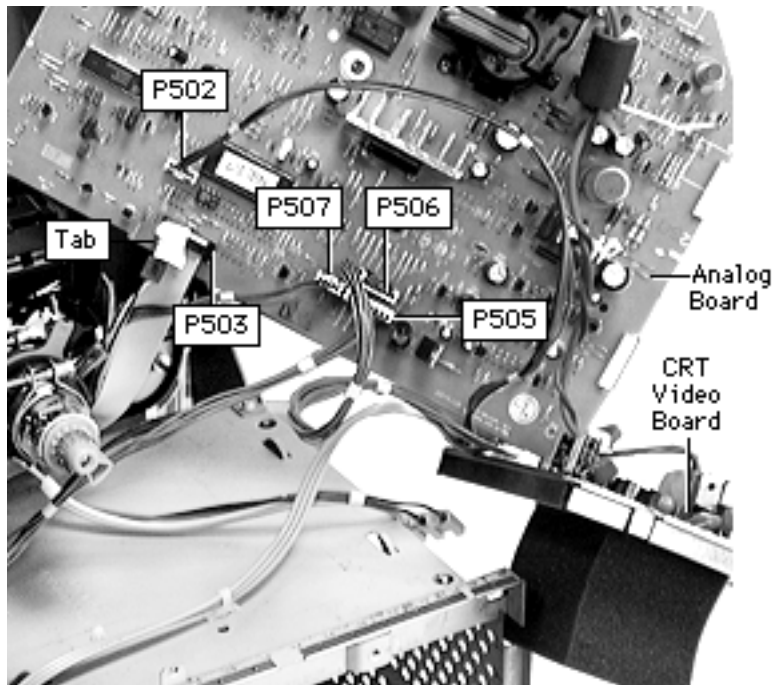

- 4 Disconnect P502, P503, P507, P506, and P505.

Important: P502, P503, P507, and P506 have clamped (or locking) connectors. Pinch or squeeze to release these connectors.

- 5 Remove analog/CRT video board from chassis.

Note: See next page for cable connection information.





On the analog board:

- P502 connects to P305 on the CRT video board
- P503 connects to P906 on power supply
- P505 connects to P913 on the power supply
- P507 connects to P908 on the power supply
- P506 connects to P302 on the CRT video board





CRT Bezel

Before you begin, remove the following:

- Top, side, and rear panel housing.
- Front door



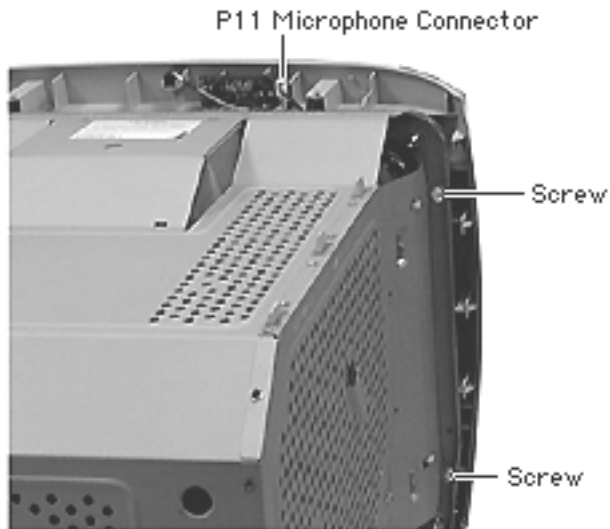

- 1 Remove the two silver torx screws located on each side of the CRT.
- 2 Disconnect the microphone cable (P11) from the microphone board.
- 3 Pull bezel off the chassis.





Speakers

Before you begin do the following:

- Remove the top, side, and rear panel housing
- Front door
- CRT Bezel
- Front panel board



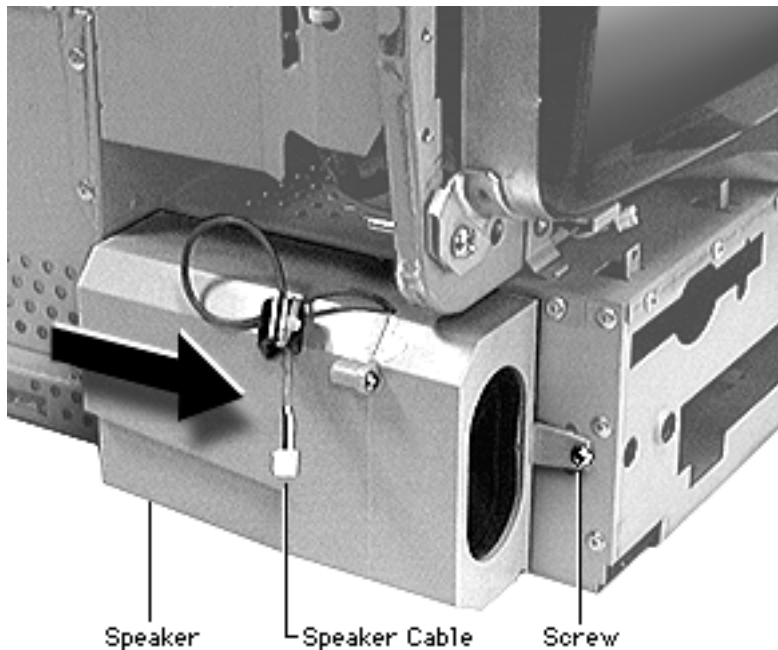

- 1 Remove speaker screw.
- 2 Speaker cable should be disconnected from sound board; gently pull speaker cable out from underneath the CRT.
- 3 Slide the speaker forward to remove it from the chassis.
- 4 Repeat steps 1-3 to remove opposite speaker.





Front Panel Board

Before you begin do the following:

- Remove the top, side and rear panel housing
- Front door
- CRT bezel

1 Remove two screws.

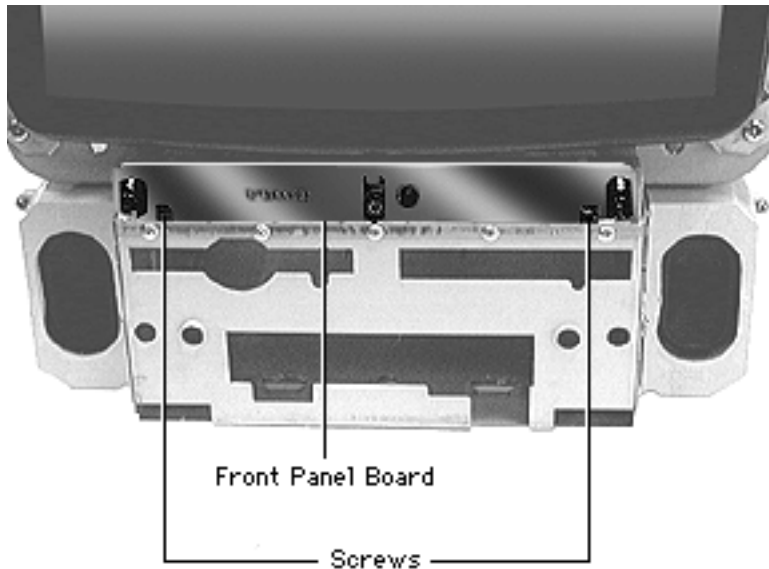

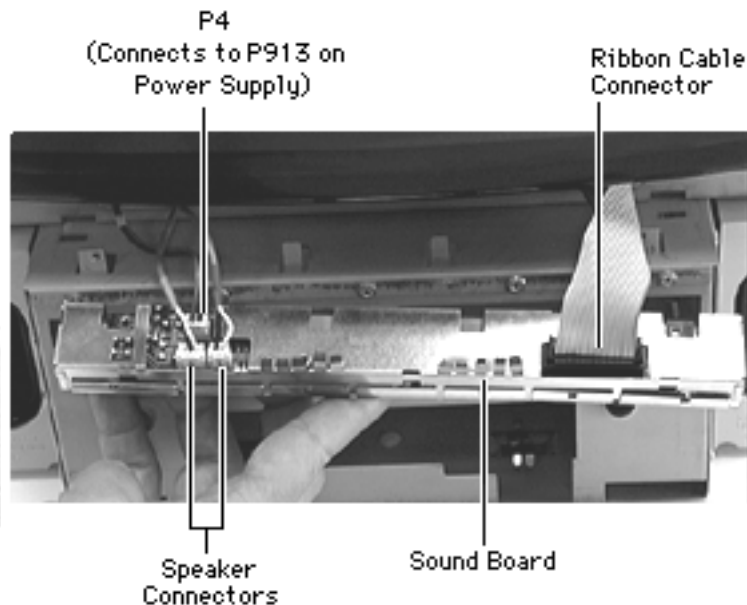

- 2 Pull front panel board forward to disconnect the three cables and ribbon connector.
- 3 Remove front panel board from chassis.



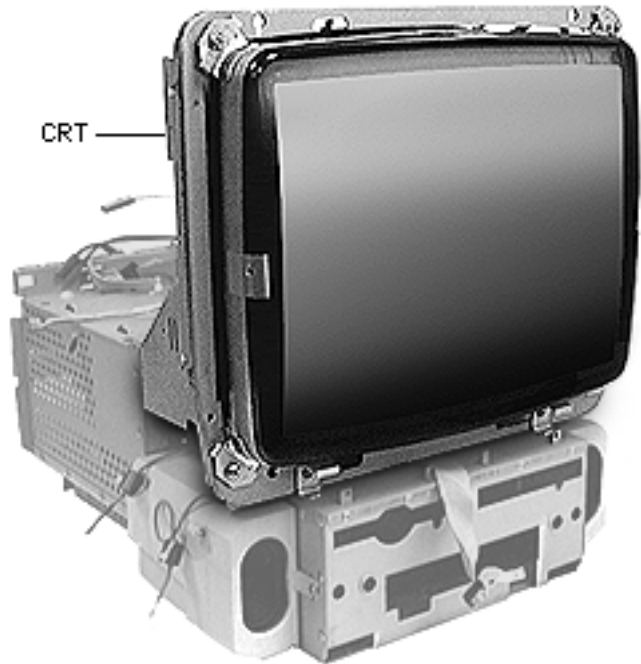

CRT

⚠ Warning: This product contains high voltage and a high-vacuum picture tube. To prevent serious injury, review CRT safety in Bulletins/Safety.

Before you begin do the following:

- Remove the chassis carrier
- Remove the top, side, and rear panel housing
- Remove the CRT EMI shield
- Discharge the CRT





- Remove the analog board
- Remove the power supply
- Remove the front door
- Remove the CRT bezel
- Remove front panel board



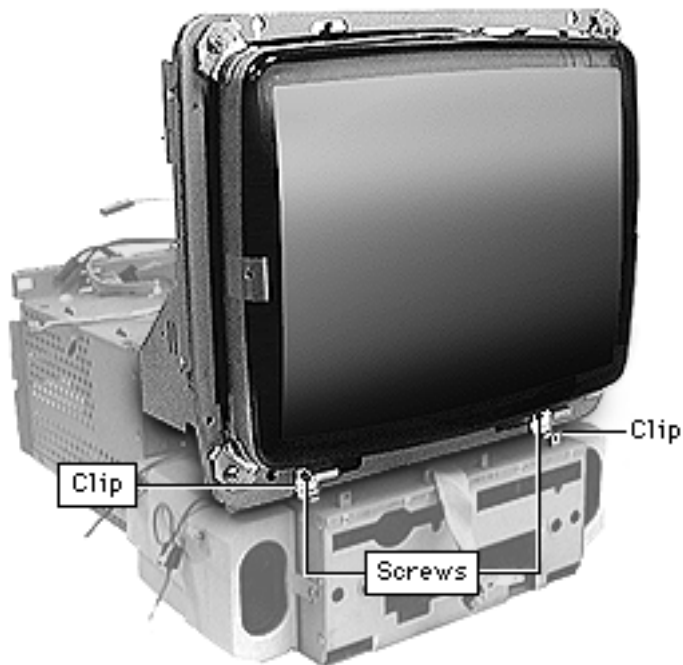

- 1 Remove the screws that secure the clips.
- 2 Remove clips.



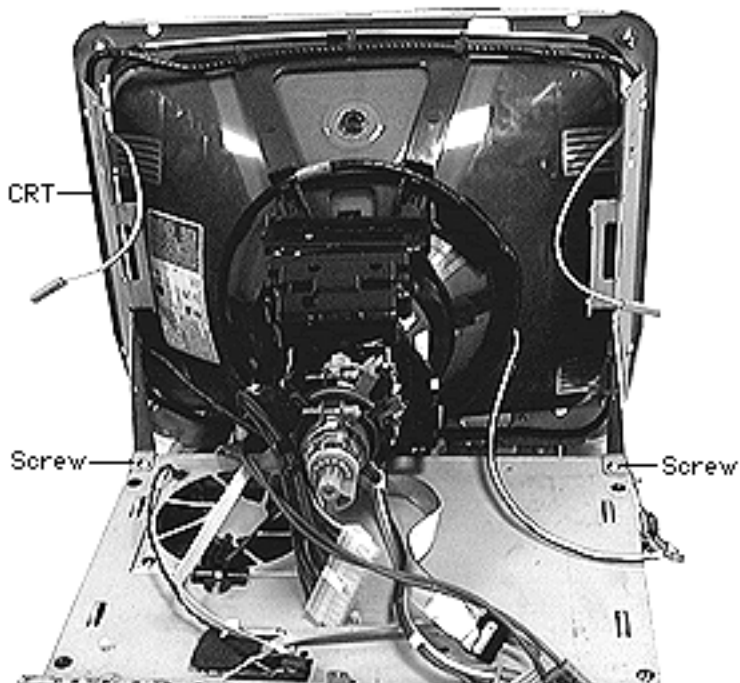

- 3 Remove two screws that secure the CRT frame to the main chassis.



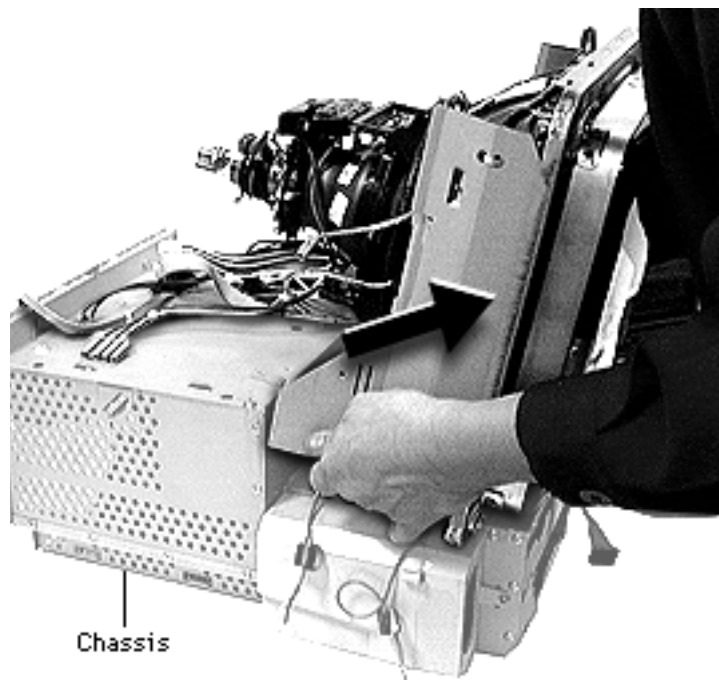

- 4 Securely hold CRT and lift CRT off the chassis.



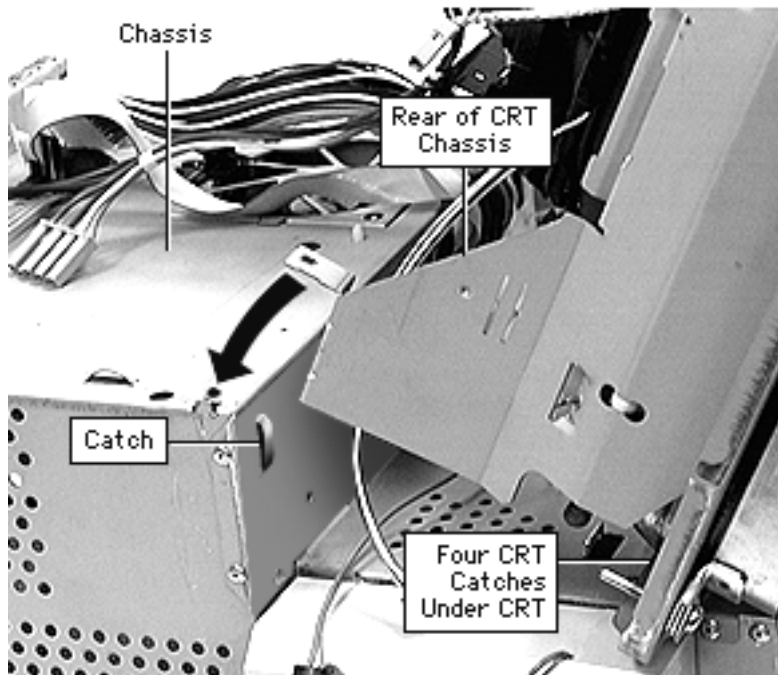

Replacement Note: Position bottom of CRT so the CRT frame connects with the four chassis catches under the front of the CRT.

Continue lowering the CRT frame onto the main chassis. Squeeze the rear of the CRT chassis frame inward so it fits inside chassis catches on either side.

Attach screw (one on other side also) where black arrow is pointing.



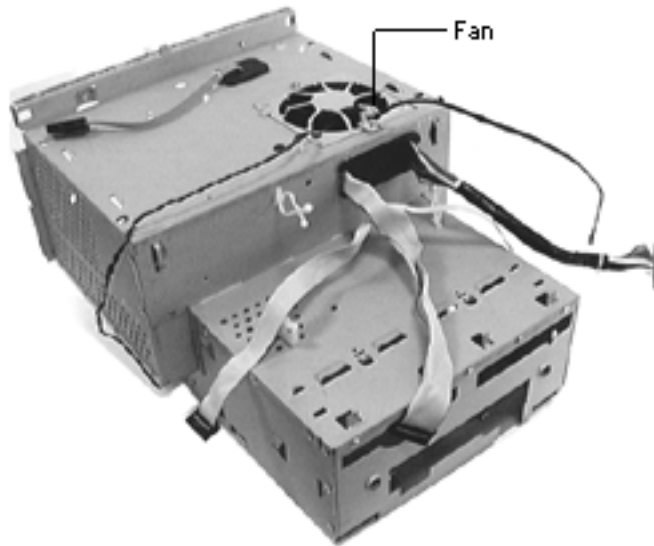

Fan

Before you begin, do the following:

- Remove the chassis carrier.
- Remove the top, side, and rear panel housing.
- Remove the CRT EMI shield
- Discharge the CRT
- Remove the analog board
- Remove the power supply



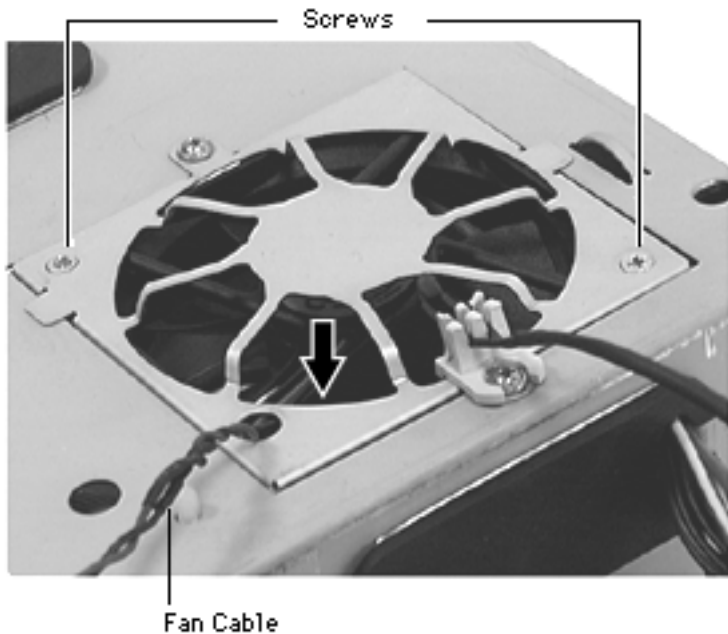

- 1 Position hand inside chassis to catch fan as it drops down when the two fan screws are removed.
- 2 Remove fan from chassis.





Thermistor

Before you begin, do the following:

- Remove the chassis carrier.
- Remove the top, side, and rear panel housing.
- Remove the CRT EMI shield
- Discharge the CRT
- Remove the analog board
- Remove the power supply

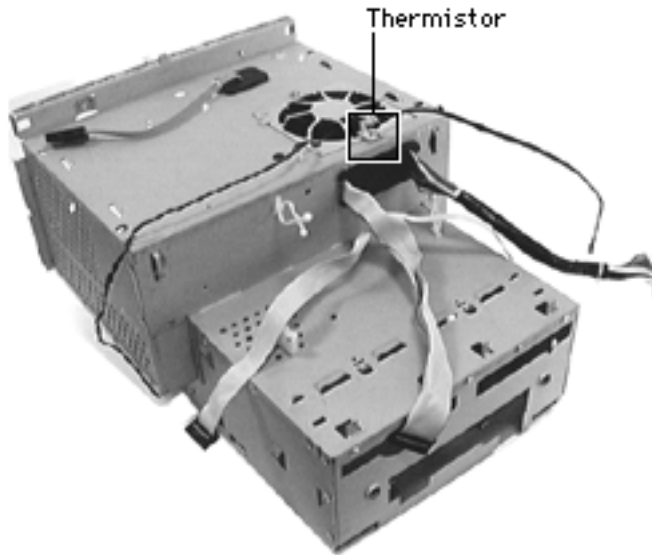

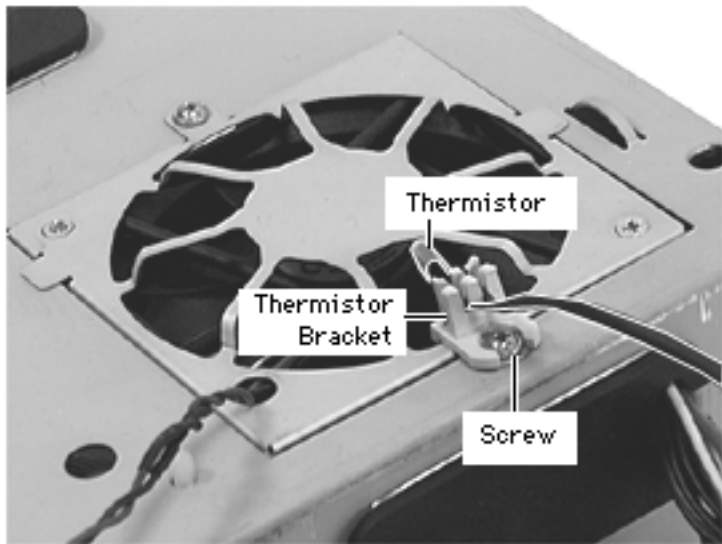

- 1 Remove screw on thermistor bracket.
- 2 Remove bracket; remove thermistor.





Chassis w/ Cables

Before you begin do the following:

- Remove the chassis carrier
- Remove the top, side, and rear housing
- Remove the CRT EMI shield
- Discharge the CRT
- Remove the analog board
- Remove the power supply
- Remove the CRT bezel
- Remove the front door
- Remove the CRT
- Remove fan and thermistor

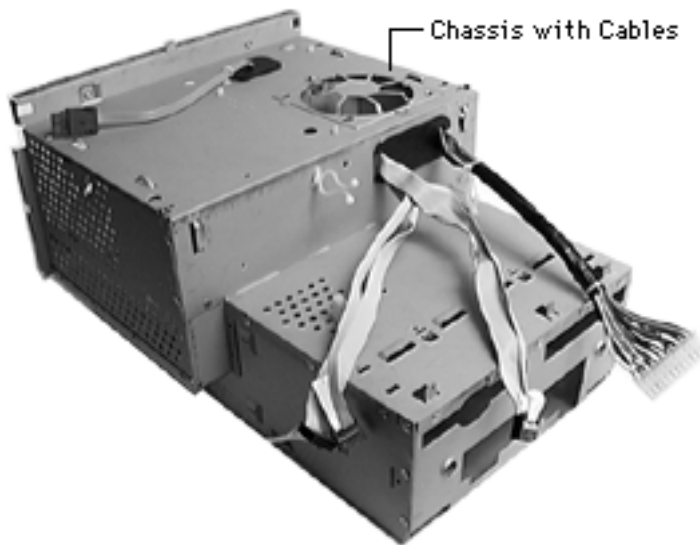



- Remove Tilt /Swivel Base

The chassis and three cables remain. The chassis with cables is part number 922-3489.

Note: These cables are available separately:

- Main power cable (922-3481)
- RGB cable (922-3480)
- Cable to I/O, front panel, analog, p/s (922-3492)

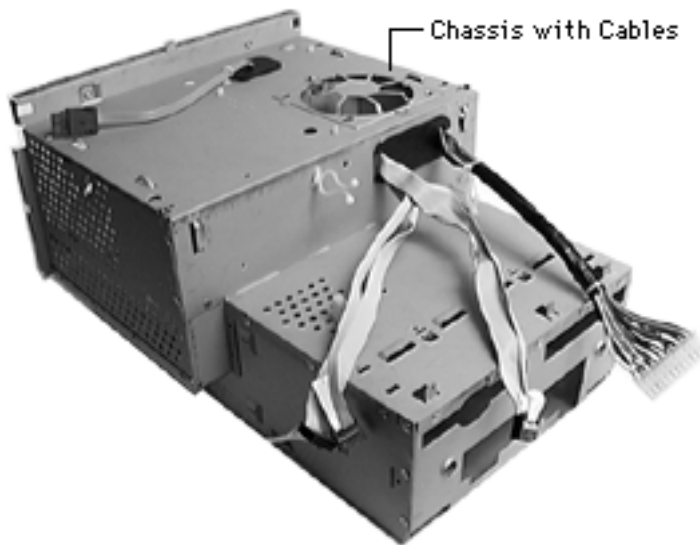



Processor Module

Before you begin, do the following:

- Remove the chassis carrier
- Remove I/O card
- Remove cable clamp support bracket

Caution: Review the ESD precautions in Bulletins/ Safety.

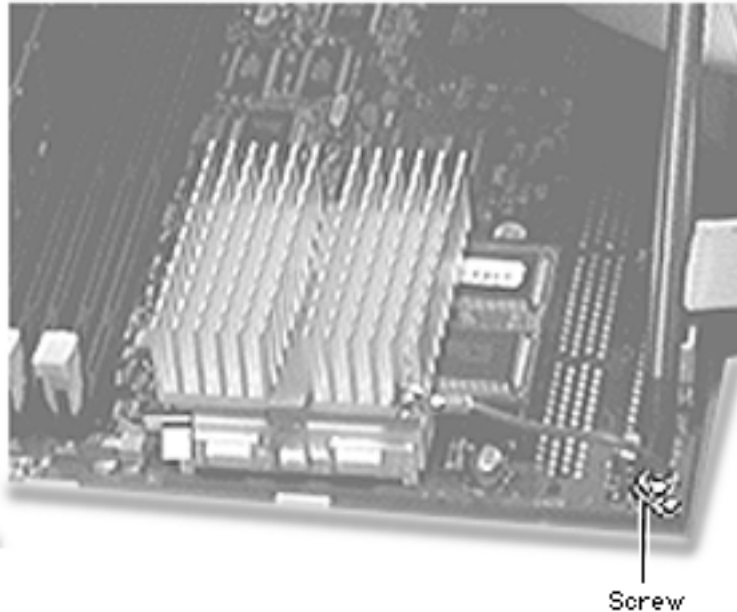

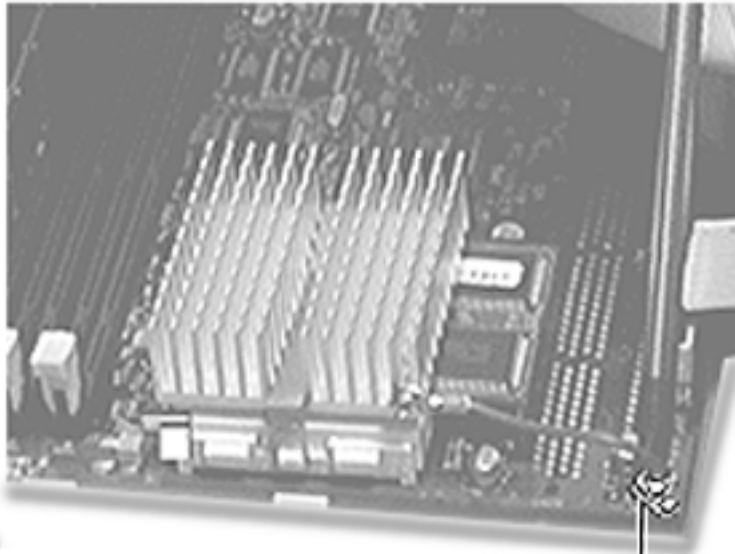

Screw

- 1 Remove the screw that holds the processor module wire to the logic board.

Replacement Note: The processor module wire attaches to the top of the logic board (not underneath). When screwing down the wire, be careful not to damage the capacitor that is next to the screw hole. Use a manual screw driver to avoid damaging the capacitor.



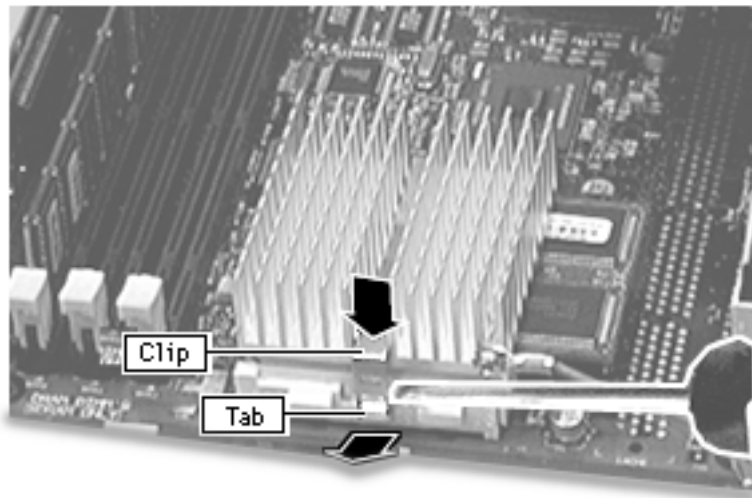

Warning: the heat sink may be hot to the touch.

- 2 While pressing down on the top of the clip that secures the heatsink, use a small flatblade screwdriver to lift up on the front tab of the clip to release it.



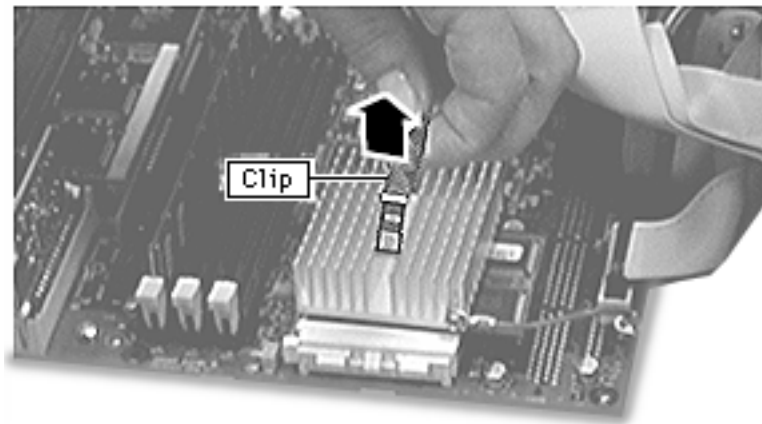

- 3 Lift up the clip and remove it from the heatsink.





- 4 Lift up the heatsink to remove it from the processor module.

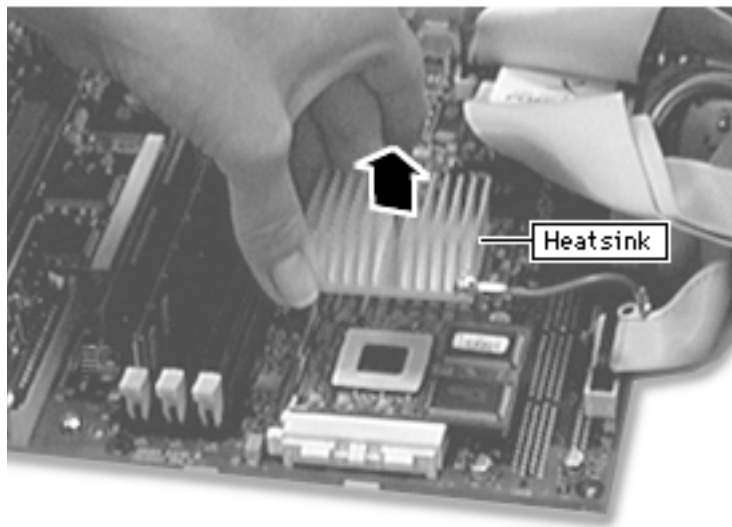

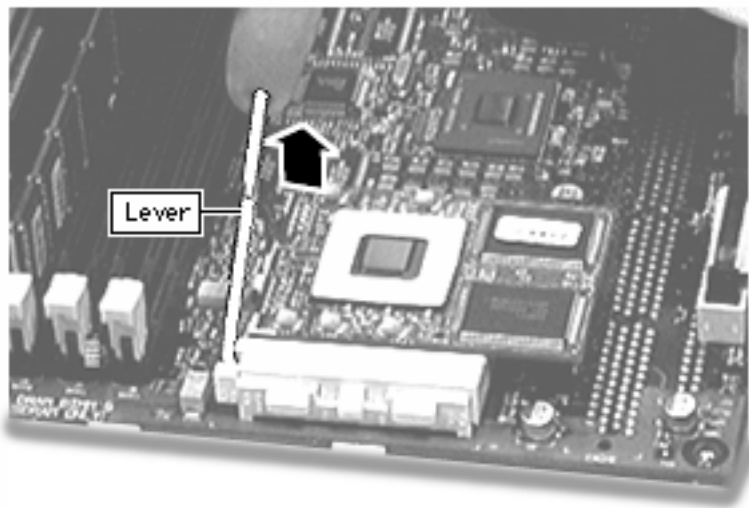

- 5 Lift the metal lever at the left of the processor module.



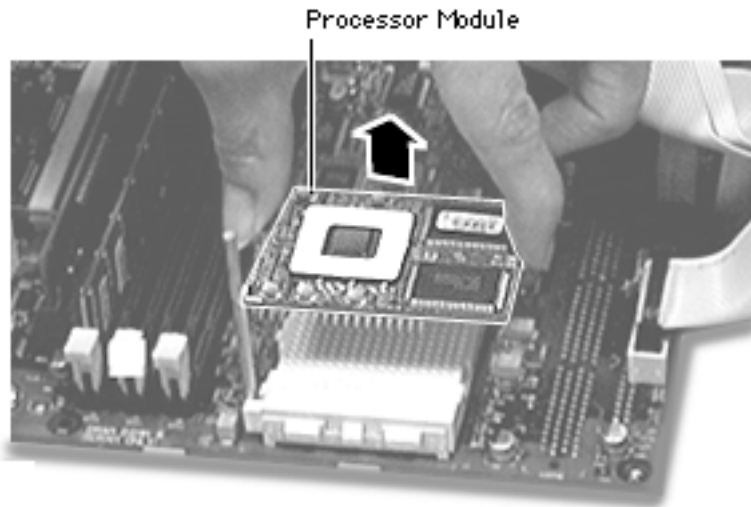

- 6 Pick up the processor module by the edges and gently lift straight up to remove it. Be careful not to bend the pins underneath the module.

IMPORTANT: If you are only replacing the processor module, stop here. If, however, you are removing the processor module in order to replace the logic board, continue on to the next page.

Replacement Note: Don't force the processor module.

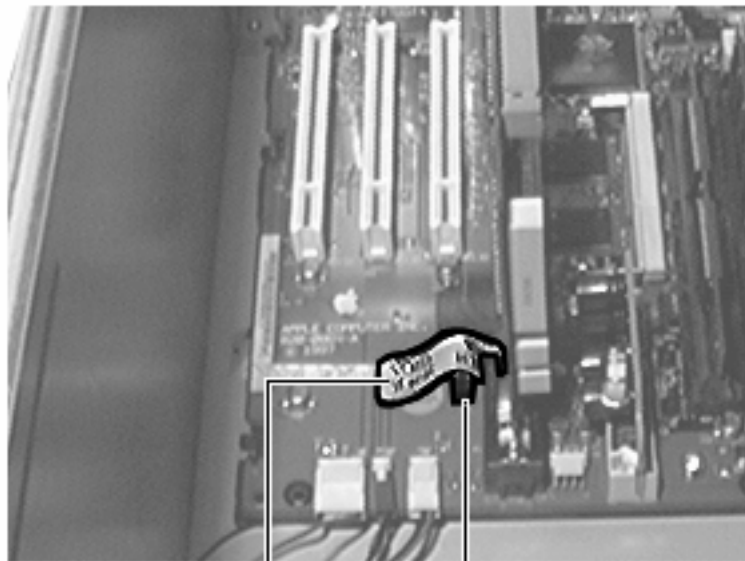

Warranty
StickerJumper
Block

- 7 Remove the warranty sticker and red jumper block located next to the battery if replacing the logic board only.

IMPORTANT: When replacing the processor module, you must change the processor jumper block and warranty sticker to be compatible with the processor module you are installing. Failure to install the jumper block properly will result in a unit that does not power on. See the instructions on the following page.





- 8 Install the jumper as shown. Depending on the computer's processor speed, you will install a red jumper (233 MHz) or a white jumper (266 MHz). Be sure to cover the pins as shown and to install the jumper block with the gold connector pins facing down towards the board.

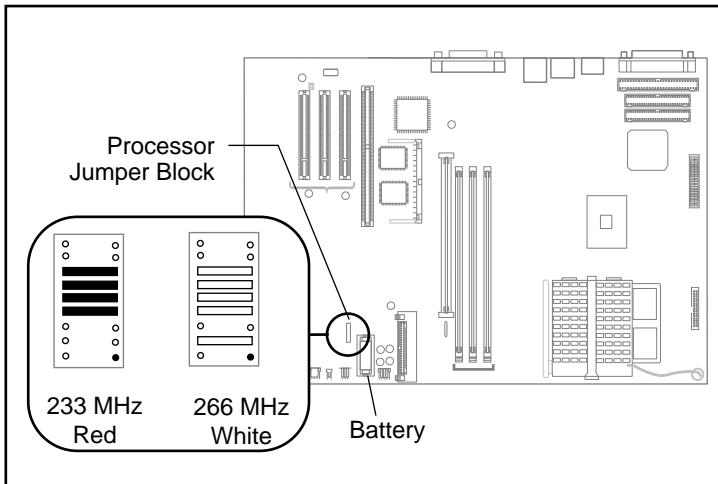

Replacement Note:
Position the processor module over the slot, seat it evenly, and press down gently on the module to



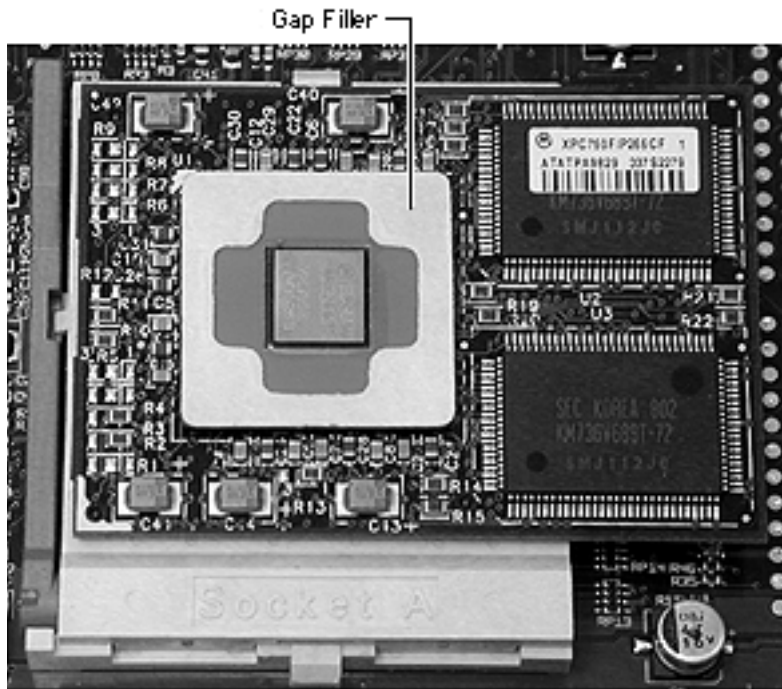

install it. Never force the module or you may damage the gold connector pins on the underside. Flip down the metal lever that secures the module to the board.

Install a gap filler, 922-3643, on a new processor.

Replace the heatsink, insert the clip onto the tab at the rear of the module, swing the clip over the heatsink, and secure the front latch.





Front Door

There are no first remove procedures for the front door.



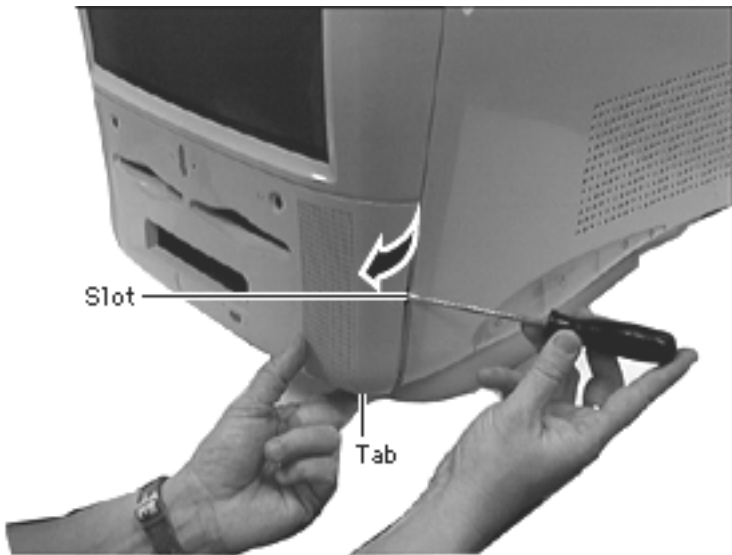

- 1 Pull down on the bottom tab while at the same time gently pry the side slot with a screwdriver to release the front door.
- 2 If necessary, repeat step one for the other side.
- 3 Remove front door from bezel.

Note: Plastic tabs on underside of front door are fragile. Be careful not to break them.





Housing

Before you begin, do the following:

- Remove the chassis carrier
- Remove the front door





- 1 Remove the four screws on the CRT bezel to release the housing from the CRT bezel.

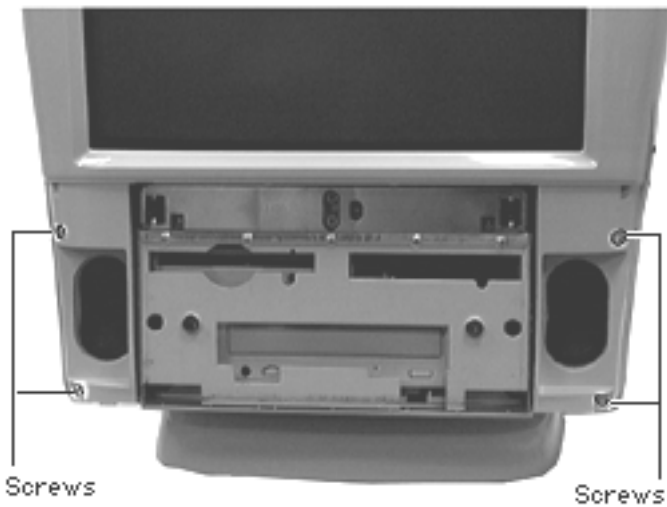

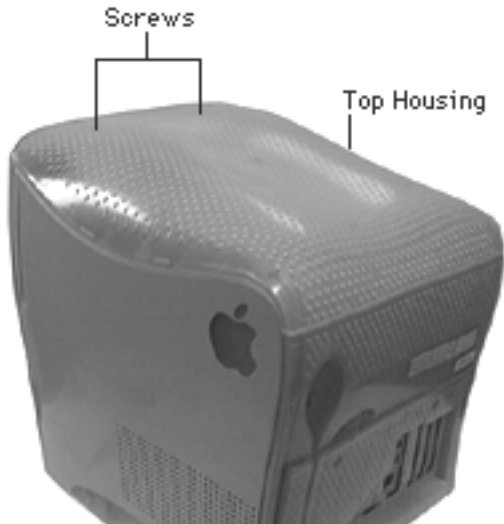

- 2 Remove the two plastic plugs covering the top panel housing screws.
- 3 Remove the two screws.



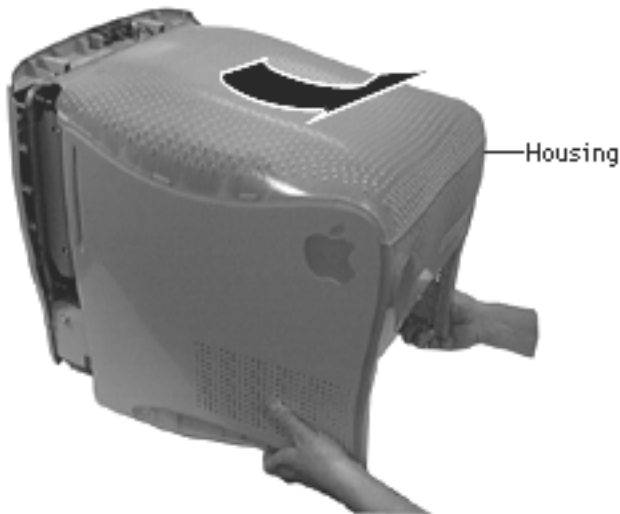

- 4 Pull housing back and lift housing off computer.

Note: The housing is removed as one unit, but separates into four parts: the top panel housing (922-3476), rear panel housing (922-3475), left side housing (922-3474), and right side housing (922-3473).

See next page for individual housing screw locations.



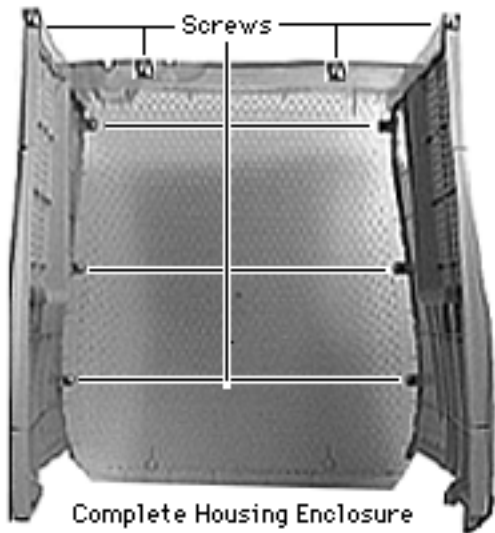

Note: This picture is a view looking inside the housing.

- 5 Remove screws (10) to separate housing into individual panels.





Tilt/Swivel Base

Before you begin, do the following:

- Remove the front door
- Remove the CRT bezel
- Remove the housing





Troubleshooting

Power Macintosh G3 All-in-One





General

New Components and Their Replacement Strategies

New components on the Power Macintosh G3 logic boards and new strategies for parts replacement make troubleshooting these systems significantly different from previous models. Take a moment to read and understand how each of these new components interacts with the system.

Voltage Regulator

The voltage regulator module regulates the voltage for the particular processor used in different Power Macintosh G3 systems. This system provides an easy way to regulate voltage without changing specific resistor values on the logic board. You can also order the voltage regulator as a separate part.





Processor Module

The Power Macintosh G3 logic board comes with a removable processor module. You can replace this module when the logic board or processor module fails. The processor module sits in a ZIF socket for easy removal. Processor modules can be ordered from Service, and each is shipped with the appropriate jumper configuration block to place in location J16. The processor should rarely fail. Replace it only as a last resort.

When replacing the processor module, you must change the processor jumper block (refer to the next topic, “Jumper Block Location J16” or “Jumper Location J28”) and warranty sticker to be compatible with the processor module you are installing. Failure to install the jumper block properly will result in a unit that does not boot up. Refer to “Processor Module” in Take-Apart for installation instructions.

Jumper Block Location J16

The jumper block you place at location J16 configures the board to work with different processor modules. Use the appropriate jumper block, identified by color, for each processor module. Refer to “Processor Module” in Take-Apart for installation instructions.





Processor Speed	Jumper Color
------------------------	---------------------

233	266
-----	-----

Red	White
-----	-------

The jumper block is protected by a void-warranty sticker. End users are not allowed to remove this jumper block. If the sticker has been tampered with on a unit you receive for repair, do not honor the service warranty on the system.





Jumper Location J28

Jumper location J28 controls which power supply the Power Macintosh G3 logic board can accommodate. When you receive a Power Macintosh G3 logic board from Service, you need to place the jumper in the proper location. The power supply used in the Power Macintosh G3 all-in-one computer is different from the power supply used in the G3 Minitower and G3 Desktop computer. The jumper should be set to “Mac Supply”

When replacing the logic board, be sure to check the power supply jumper setting. If this jumper is missing or set incorrectly for the computer model, the computer will not boot up

I/O Card Required

Power Macintosh G3 computers require an I/O card that moves audio and/or video from the main logic board. These cards are placed in the PERCH connector on the main logic board. If the card is not seated correctly, different symptoms appear. Look in the Symptom Charts for details on troubleshooting these cards. **Note:** The Power Macintosh G3 computers will boot up without the I/O card installed, but they will not operate properly.





Cleaning Procedure for Card Connectors

It is possible for residue to build up on the gold edge connector pins on some PCI cards, which could cause a variety of symptoms.

If you are having problems with a PCI card, inspect the connector pins with a magnifying glass. If you find residue, use a pencil eraser to gently clean the pins.





Symptom Charts

System

Fan is running, but no startup chime, screen is black, drive not accessed at startup, and no LED on front of system

1. Check jumper block J28. Be sure setting is correct for type of power supply installed (see “Logic Board” in Take-Apart chapter for more information).
2. Check jumper block configuration at J16. Make sure jumper block is correct color for processor type installed (see “Processor Module” in Take-Apart chapter).
3. Reseat processor module. Make sure locking arm is in down position.
4. Reseat ROM DIMM.
5. Replace voltage regulator.
6. Replace logic board.
7. Replace processor module.
8. Replace analog board.





Fan is running, LED is on, drive is accessed at startup, but no startup chime and screen is black

1. Check jumper block J28. Make sure setting is correct for type of power supply installed (see “Logic Board” in Take-Apart chapter for more information).
2. Reseat ROM DIMM.

No apparent power, fan isn't running, no LED

1. Verify power cord is attached securely at both ends.
2. Check internal power cables and verify they are attached securely.
3. Reseat ROM DIMM and processor module. The logic board must have both a ROM DIMM and processor module installed to operate.
4. Reset Cuda chip. (Refer to “The Cuda Chip” in Basics chapter for instructions.)
5. Reset logic board. (Refer to “Resetting the Logic Board” in Basics chapter for instructions.)
6. Check jumper block J28. Make sure setting is correct for type of power supply installed (see “Logic Board” in Take-Apart chapter for more information).
7. Check jumper block configuration at J16. Make sure jumper block is correct color for





processor type installed (see “Processor Module” in Take-Apart chapter for more information).

8. Replace power cord.
9. Replace voltage regulator.
10. Replace power supply.
11. Replace analog board
12. Replace logic board.
13. Replace processor module.

Clicking, chirping, thumping, or rubbing noise

1. Remove all PCI cards and test unit. If problem does not occur with cards removed, begin replacing cards one at a time to determine which card is causing problem. Replace problem card with known-good card.
2. Remove hard drive. If problem no longer occurs, replace hard drive with a known-good drive.
3. Replace power supply.
4. Replace analog board.





5. Replace processor module.
6. Replace logic board.
7. Replace floppy drive cable.
8. Replace floppy drive.
9. Replace I/O card.

System shuts down intermittently

1. Make sure air vents are clear. Thermal protection circuitry may shut down system. After 30 to 40 minutes, system should be OK.
2. Make sure power cord is plugged in firmly. Replace power cord.
3. Check battery.
4. Reset Cuda chip. (Refer to “The Cuda Chip” in Basics chapter for instructions.)
5. Reset logic board. (Refer to “Resetting the Logic Board” in Basics chapter for instructions.)
6. Replace power supply.
7. Replace logic board.
8. Replace processor module.





System intermittently crashes or hangs

1. Verify system software is version 8.1 with enabler.
2. Verify software is known-good. Do a clean install of system software.
3. Verify software is Power Macintosh compatible (contact developer). Also, try booting with extensions off to determine if there are system init problems.
4. Clear parameter RAM. Hold down <Command> <Option> <P> <R> during startup but before "Welcome to Macintosh" appears.
5. Remove all SDRAM DIMMs and try replacing them one at a time to test. Replace any bad DIMMs.
6. Replace logic board.
7. Replace processor module.

During startup, following message is displayed, "This startup disk will not work on this Macintosh model...."

1. Verify startup disk is good.
2. Verify system software is version 8.1 with enabler.
3. Do a clean install of system software.





Computer boots to the desktop, but only a white menu bar appears, no icons appear, and the mouse freezes.

1. Verify that a cable (922-3519) is connected to the P4 connector on the front panel control board (922-3446).
2. If the cable is connected, inspect it for damage. Replace the cable.
3. Replace the front panel control board.





Error Chords

One-part error chord sounds during startup sequence

1. Disconnect IDE data cable from hard drive and reboot system. If startup sequence is normal, initialize hard drive. Test unit again with IDE data cable connected. If error chord still sounds, replace hard drive.
2. Disconnect floppy drive cable from floppy drive and reboot system. If startup sequence is normal, replace floppy drive.
3. Reseat processor module.
4. Replace logic board.
5. Replace processor module.

Eight-part error chord (death chimes) sounds during startup sequence

1. Replace SDRAM DIMMs one at a time to test SDRAM. Replace any faulty DIMMs.
2. Replace logic board.





Video

Screen is black or green, but boot tone is present, drive operates, fan is running, and LED is lit

1. Adjust brightness on monitor.
2. Clear parameter RAM. Hold down <Command> <Option> <P> <R> during startup but before "Welcome to Macintosh" appears.
3. Reseat the Audio/Video I/O card. Replace the card with a known good I/O card.
4. Reset Cuda chip. (Refer to "The Cuda Chip" in Basics chapter for instructions.)
5. Reset logic board. (Refer to "Resetting the Logic Board" in Basics chapter for instructions.)
6. Check cable connections on analog and CRT video board.
7. Check that P505 connects to P913 **and** P905 on the power supply board.
8. Check that P507 connects to P908 on the power supply.
9. Replace RGB monitor cable.
10. Remove all SDRAM DIMMs and try replacing them one at a time to test. Replace any bad DIMMs.





11. Replace logic board.
12. Replace processor module.

Screen is black or green, no boot tone and drive does not operate, but fan is running and LED is lit

1. Reset Cuda chip. (Refer to “The Cuda Chip” in Basics chapter for instructions.)
2. Reset logic board. (Refer to “Resetting the Logic Board” in Basics chapter for instructions.)
3. Remove all SDRAM DIMMs and try replacing them one at a time to test. Replace any bad DIMMs.
4. Reseat the Audio/Video I/O card. Replace the card with a known good I/O card.
5. Check cable connections on analog and CRT video board.
6. Check that P505 connects to P913 **and** P905 on the power supply board.
7. Check that P507 connects to P908 on the power supply.
8. Replace RGB monitor cable.
9. Replace analog board.
10. Replace power supply.





11. Replace processor module.

Boot tone is present and screen lights up, but nothing is displayed on screen

1. Reset Cuda chip. (Refer to “The Cuda Chip” in Basics chapter for instructions.)
2. Reset logic board. (Refer to “Resetting the Logic Board” in Basics chapter for instructions.)
3. Reseat the Audio/Video I/O card. Replace the card with a known good I/O card.
4. Check cable connection on analog and CRT video board.
5. Check that P505 connects to P913 **and** P905 on the power supply board.
6. Check that P507 connects to P908 on the power supply.
7. Replace analog board.
8. Replace logic board.
9. Replace processor module.

Predominant color tint

1. Perform video adjustments. (Refer to “Video” in the Adjustments chapter.)
2. Check cable connection on analog and CRT video board.





3. Replace RGB video cable.
4. Replace analog/video board. Perform video adjustments. (Refer to “Video” in the Adjustments chapter.)
5. Replace CRT.

Horizontal flickering lines when viewing Apple Video Play application with TV Mirroring on

Replace the Audio/Video card with a Version II Audio/Video card (p/n 661-2044).

TV Mirroring is enabled but no image is appearing on TV

Refer to TIL article 24816 for how to verify that video output from Audio/Video card is working.





Floppy Drive

Internal floppy drive does not operate

1. Replace floppy disk with known-good disk.
2. Replace floppy drive cable.
3. Replace floppy drive.
4. Replace logic board.
5. Replace processor module.

During system startup, disk ejects; display shows icon with blinking "X"

1. Replace disk with known-good system disk.
2. Replace floppy drive cable.
3. Replace floppy drive.
4. Replace logic board.
5. Replace processor module.





Disk does not eject

1. Switch off computer. Hold down mouse button while you switch computer on.
2. Replace floppy drive cable.
3. Replace floppy drive.
4. Replace logic board.
5. Replace processor module.

Drive attempts to eject disk, but doesn't

1. Reseat floppy drive bezel and drive so bezel slot aligns correctly with drive.
2. Replace floppy drive.

Internal floppy drive runs continuously

1. Replace disk with known-good floppy disk.
2. Replace floppy drive cable.
3. Replace floppy drive.
4. Replace logic board.
5. Replace processor module.





MS-DOS drive does not recognize a disk formatted on a 1.4 MB drive

To read and write files with either MS-DOS or 1.4 MB drive, format all disks with MS-DOS drive first.





Hard Drive

Single internal hard drive does not operate; drive doesn't spin

1. Replace hard drive power cable.
2. Replace hard drive. If problem resolved, reinstall IDE device driver and system software.
3. Replace power supply.

No internal SCSI drives operate

1. Verify there are no duplicate SCSI device addresses on a single SCSI bus.
2. Disconnect external SCSI devices and check for proper termination. Only last device in SCSI chain should be terminated.
3. Check internal SCSI devices for proper termination.
4. Replace internal SCSI data cable to which non-operational devices are attached.
5. Replace power supply.
6. Replace logic board.
7. Replace processor module.





Works with internal or external SCSI devices but not with both

1. Verify there are no duplicate SCSI device addresses
2. Replace terminator on external SCSI device.
3. Verify that SCSI device at end of internal SCSI data cable is only device terminated.
4. Refer to appropriate manual to troubleshoot defective external device.





Peripherals

Cursor does not move

1. Check mouse connection.
2. Inspect inside of mouse for buildup of dirt or other contaminants. Clean mouse if necessary. **Note:** The mouse contains a ball and several rollers that must remain clean. If either the ball or rollers are dirty, the mouse might not track properly. Refer to Tech Info Library article 6491: “How To Clean A Mouse.”
3. If mouse was connected to keyboard, connect mouse to computer ADB port instead. If mouse works, replace keyboard.
4. Replace ADB cable.
5. If mouse does not work in any ADB port on computer, replace mouse.
6. Replace logic board.
7. Replace processor module.

Cursor moves, but clicking mouse button has no effect

1. Boot from floppy or bootable CD.





2. Replace mouse.
3. Replace logic board.

Double-click doesn't open application, disk, or server

1. Remove duplicate system folders.
2. Clear parameter RAM. Hold down <Command> <Option> <P> <R> during startup but before "Welcome to Macintosh" appears.
3. If mouse was connected to keyboard, connect mouse to computer ADB port instead. If mouse works, replace keyboard.
4. If mouse does not work in any ADB port on computer, replace mouse.
5. Replace logic board. Retain customer's DIMMs.

No response to any key on keyboard

1. Check keyboard connection to ADB port.
2. Replace keyboard cable.
3. Replace keyboard.
4. Replace logic board.





Known-good serial printer does not work

1. Verify you have correct version of system software.
2. Verify that Chooser is set correctly.
3. Reinstall correct printer drivers.
4. Do clean install of system software.
5. Replace printer interface cable.
6. Replace logic board. Retain customer's DIMMs.

Known-good network printer does not print

1. Check network connections.
2. Verify you have correct version of system software.
3. Verify that Chooser is set correctly.
4. Does printer show up in Chooser? If so, do clean install of system software and/or network and printer software.
5. Replace logic board. Retain customer's DIMMs.





CD-ROM Drive

CD-ROM drive does not work

1. Try using known-good compact disc.
2. Replace CD-ROM drive mechanism.

Macintosh does not display CD-ROM icon once CD is inserted in drive

1. Try using known-good compact disc.
2. Verify that CD-ROM software is installed.
3. Reinstall CD-ROM software.
4. Reseat CD-ROM data cable at logic board connector and at CD-ROM connector.
5. Replace CD-ROM drive mechanism.
6. Replace CD-ROM data cable.





Miscellaneous

No sound from speaker

1. Disconnect any microphones or external speakers.
2. Verify that volume setting in Control Panel is adequate and mute is not checked.
3. Clear parameter RAM. Hold down <Command> <Option> <P> <R> during startup but before "Welcome to Macintosh" appears. Verify speaker is plugged into logic board.
4. Plug headphones or external speakers into the external jack. If the external jack works, replace the internal speaker or logic board. If the external jack doesn't work, proceed to the next step.
5. Replace I/O Audio card.
6. Replace speaker.
7. Replace logic board.

Ethernet connection drops off line by itself

Install Ethernet driver 2.0.4 or later.





Adjustments

Power Macintosh G3

All-in-One





Adjustment Tools

The following items are needed to perform video adjustments on the iMac:

- Display Adjustment Utility 4.0
- a light meter

The utility can be found on the Service Source CD or online at: <http://service.info.apple.com>.





Light Meter Setup

This topic covers setup for three light meter models: R77, L-248, and 246. Model R77 (Apple part number 076-0310) is the newest model available.

Model R77

The R77 light meter is capable of reading luminance from 10 to 1,000 footcandles (fc).

Before you begin, remove the 10X multiplier plate from the lens.



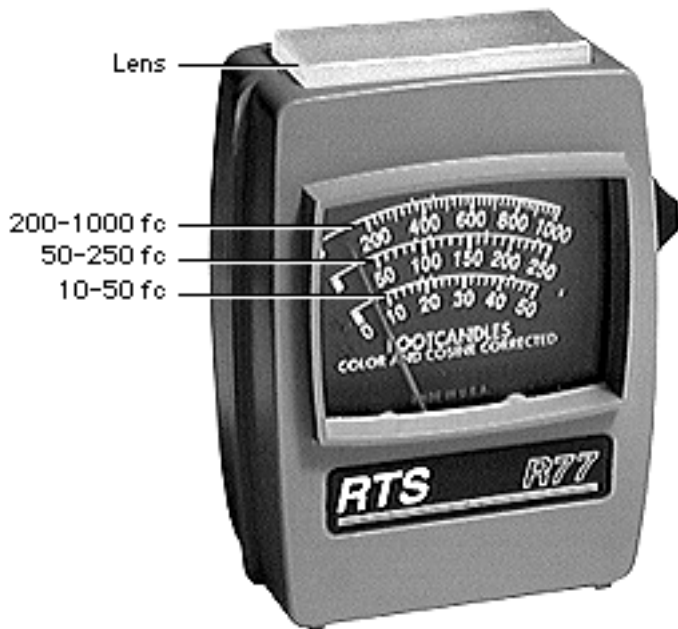

Three scales are shown on the light meter:

- 200-1000 fc
- 50-250 fc
- 10-50 fc

Because display screen luminance typically ranges from 10 to 50 fc, take readings from the bottom scale only.



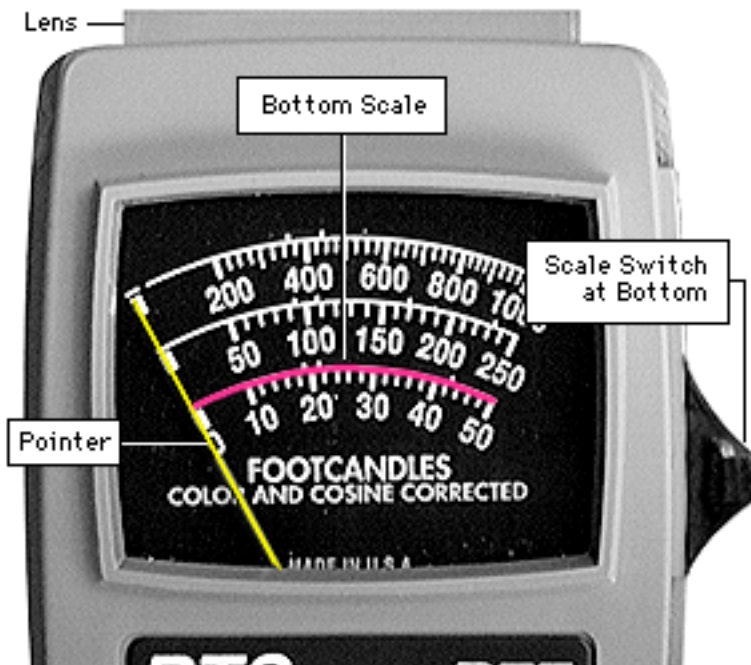

To measure a display screen's luminance,

1. Set the scale switch to the bottom position (to set up the 10-50 fc scale).
2. Place the lens against the middle of the screen and read the bottom scale.

Note: When the light meter is not in use, slide the scale switch to its top position, and store the meter in its protective case.





Important: If you suspect the light meter is giving false readings, verify the readings with a known-good light meter or photometer. Also check the age of the R77 light meter by its four-digit manufacturing date stamp (such as 0398 for March 1998).

Caution: Dropping the meter can permanently damage its accuracy. A shock-damaged meter might read incorrectly or its pointer may not drop to zero.



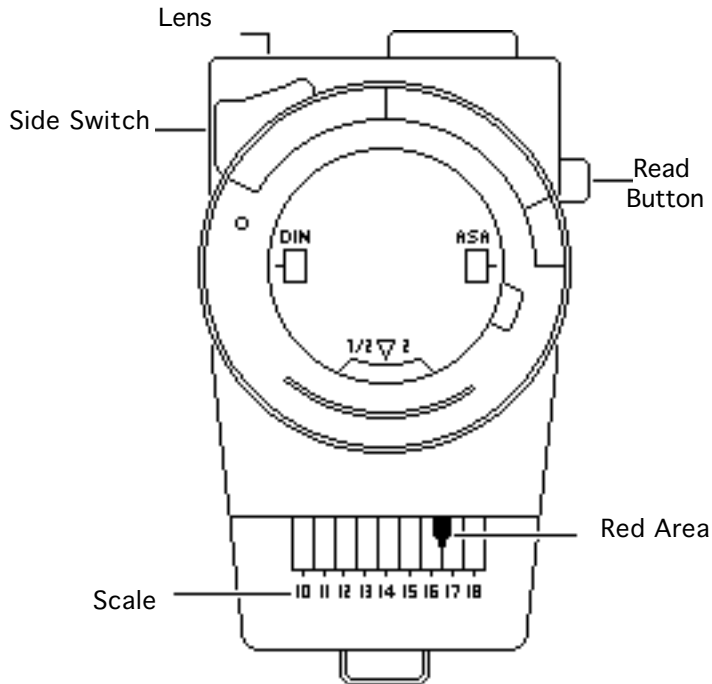

Model L-248

1. Press the red button on the back of the light meter. If the reading is out of the red area, replace the battery.
2. Move the side switch to its upper position so that the scale reads 10 through 18.
3. Uncover the lens of the meter.
4. Place the lens against the middle of the screen and press the read button to read the scale.



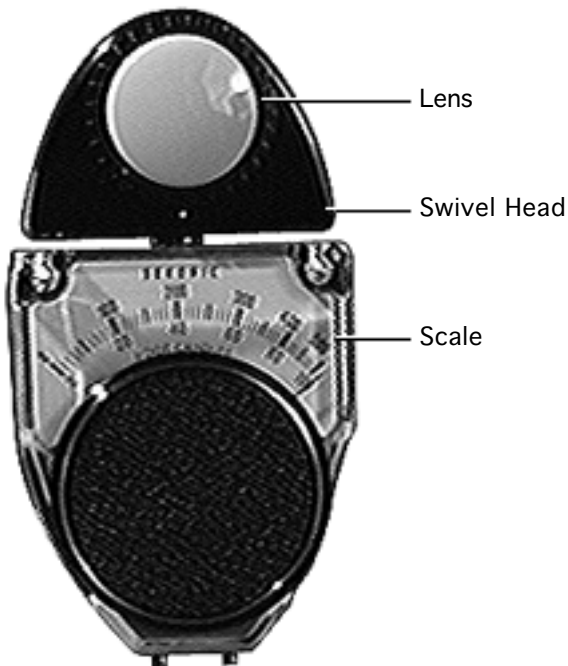

Model 246

This topic covers setup for light meter Model 246.I

1. Remove the metal slide, if installed, from the top of the light meter.
2. Install the white lens with the red dot.
3. Swivel the head so the lens of the meter faces the monitor.
4. Place the lens against the middle of the screen and read the scale.



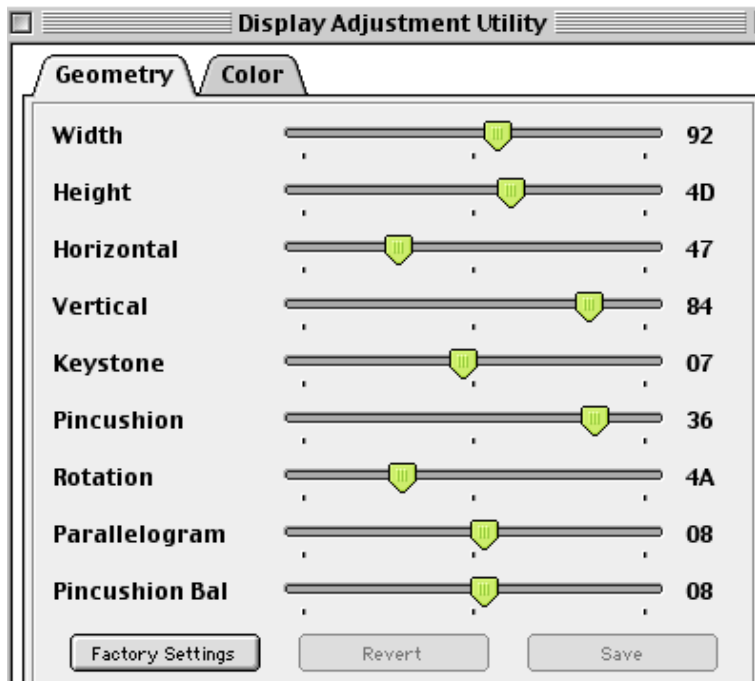

Geometry

1. Open the Display Adjustment Utility, and adjust the geometry settings by moving the appropriate slider bar.
2. When done, save your adjustments.

Note: Geometry adjustments are also accessible through the Monitors & Sound control panel.





Saving Geometry Settings for Multiple Resolutions

Important: In order to save a set of adjustments in the Display Adjustment Utility, for a specific resolution you **must** first click the “Save” button and then quit the Display Adjustment Utility. Only after quitting, does the utility save the adjustments you made to a particular resolution. Failure to quit the utility before changing resolutions will cause the previous adjustments to be lost.





Using Monitors & Sound Control Panel

To adjust user settings

1. Click the Monitor button to adjust color depth, resolution, contrast and brightness.
2. Click the Geometry button to make geometry adjustments.

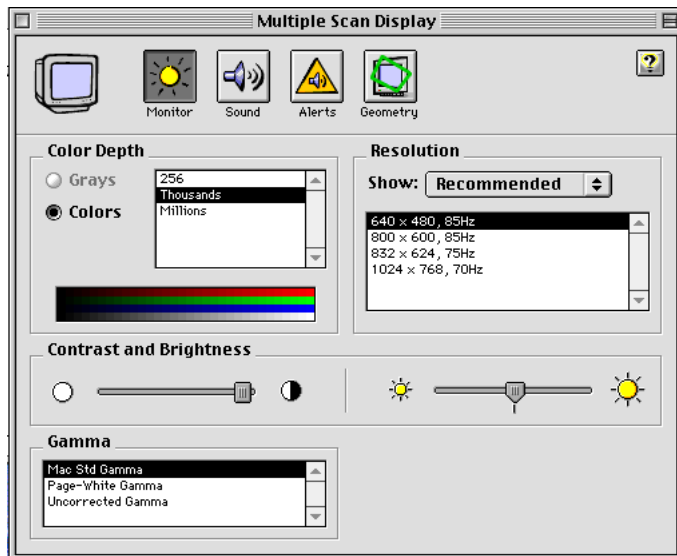

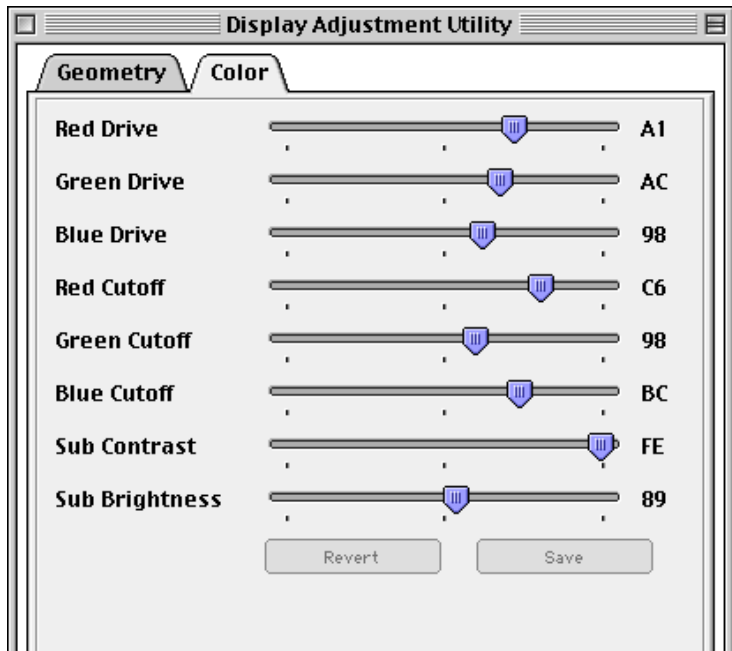

Video

Use the Display Adjustment Utility to perform the Cutoff and White Balance adjustments. This utility can be found online, on the Service Source Companion 2 CD, and on the MacTest Pro Diagnostic CD.

Replacement Note:

Perform the cutoff adjustment whenever you replace the CRT or the analog /video board.



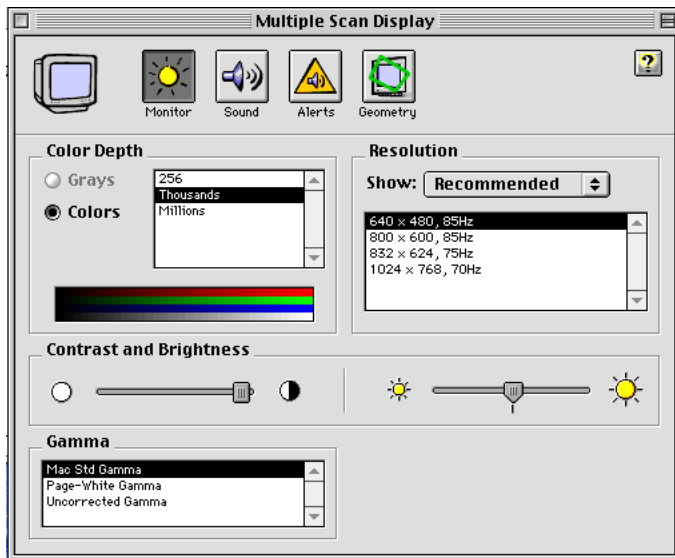

Cutoff

Perform the cutoff adjustment prior to adjusting the white balance. Make sure the monitor has been on for at least 10 minutes.

1. Using the Monitors & Sound Control Panel, set the contrast to maximum and brightness to midrange.
2. Set the display resolution to 640 x 480.



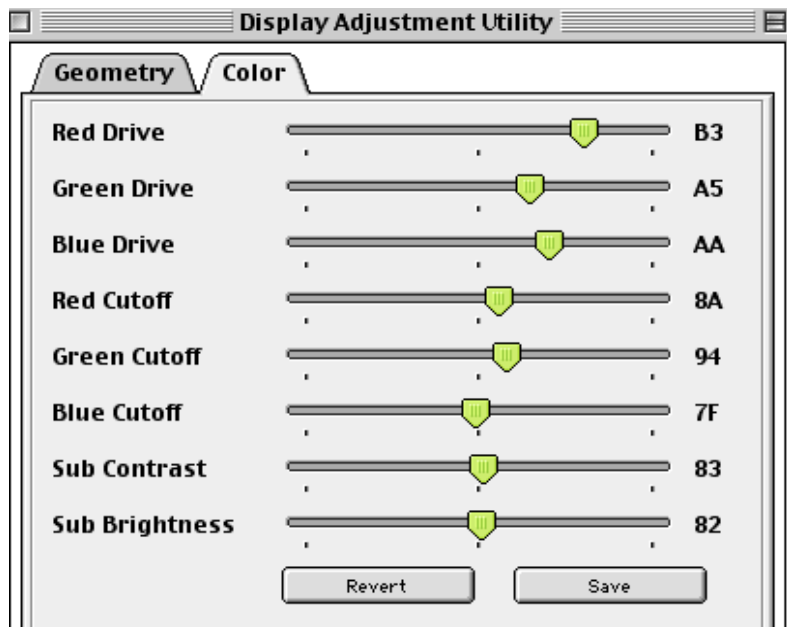

- Using the Color tab window, move the Sub Contrast and Sub Brightness controls to midrange.



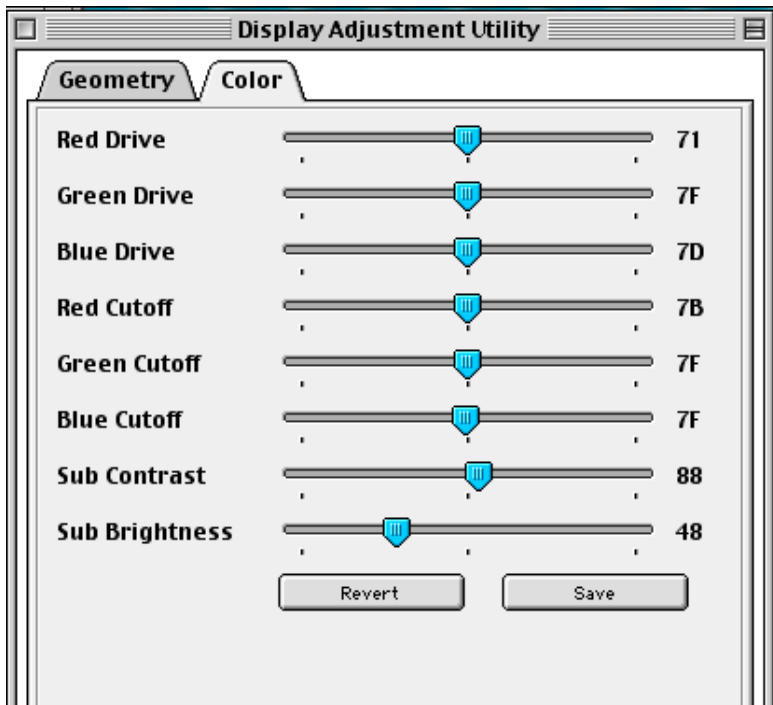

4. Set the drive and cutoff controls to their midpoint positions.

Note: Next, you will need to switch back and forth between the Gray Bars test pattern (under the Pattern menu) and the Color Adjustment window.





Pattern	Help
Gray Bars	
Black	
White	
Red	
Green	
Blue	
White Grid	
Black Grid	
Focus	

5. Select the Gray Bars test pattern from the Pattern menu.

This procedure should be performed in a dimly lit room.





6. Look at the Gray Bar Test pattern.
 - the bars should have no predominant color
 - the leftmost bar should be as black as the screen border
 - the second bar (from the left) should be barely visible
 - the third bar should be dark gray



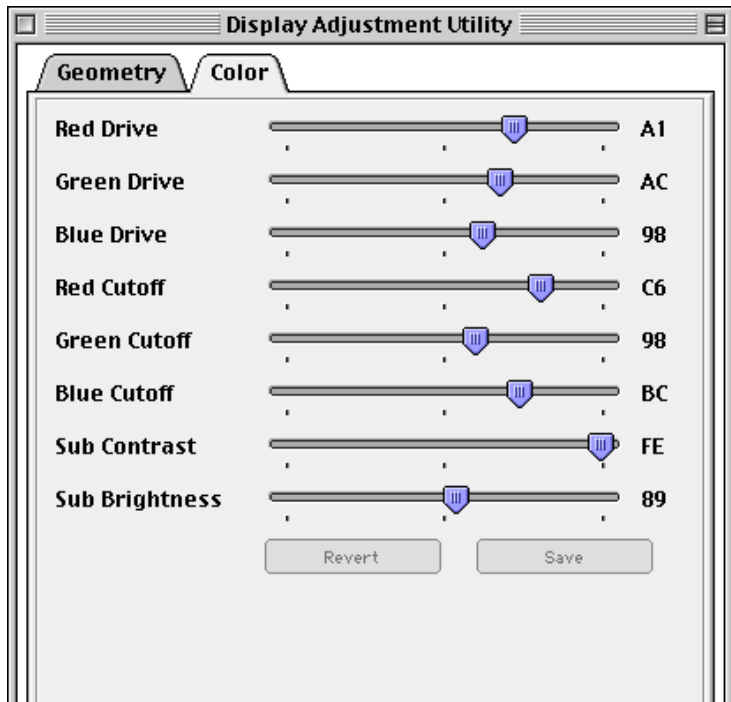

- Adjust the red, green, and blue cutoff controls together until the second gray bar (from the left) is barely visible.

Important: If any color adjustments are turned down too far, and the screen goes completely dark, press the Command-R keystroke combination to revert the screen to the previous setting.



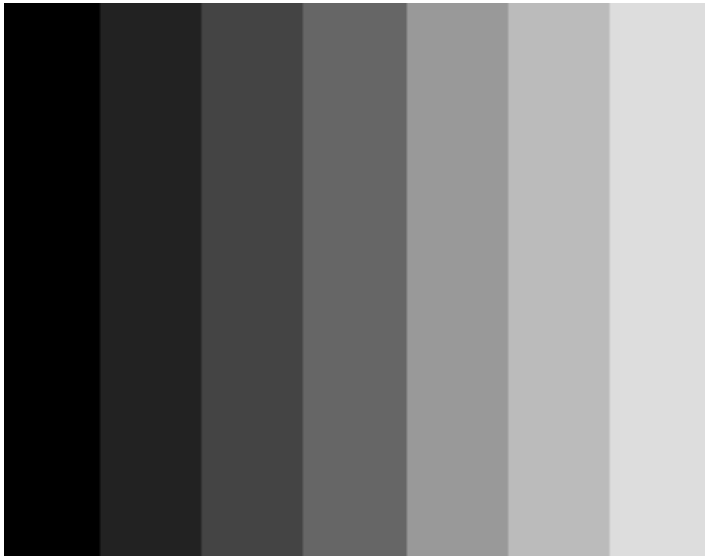

8. Check the Gray Bars test pattern. If there is a predominant color in the three gray bars (on the left), adjust the color accordingly in the utility until there is no predominant color.





9. The cutoff is now set correctly. You should see shades of black and gray and the second bar (from the left) is barely visible.
10. Click the Save button in the Color window to save your settings.
11. Proceed to the White Balance adjustment.





White Balance

Make sure the cutoff is set correctly before you proceed and that the monitor has been on for at least 10 minutes.

1. Open the Display Service Utility and select the Gray Bars test pattern from the Pattern menu.

Pattern	Help
Gray Bars	
Black	
White	
Red	
Green	
Blue	
White Grid	
Black Grid	
Focus	





Geometry **Color**

Red Drive		A1
Green Drive		AC
Blue Drive		98
Red Cutoff		C6
Green Cutoff		98
Blue Cutoff		BC
Sub Contrast		FE
Sub Brightness		89

Revert Save

2. Hold a light meter on the white bar (last bar on the right). Adjust the red, green, and blue drive controls until the light meter reads one of the following:
 - 18 foot candles on light meter R77
 - 18 foot candles on light meter L246
 - Middle of 9 on the 1 through 10 scale of light meter Model L-248

Note: The drive slider bars adjust the lighter bars.





Important: If a predominant color is displayed in the three left gray bars, adjust the cutoff controls until you see no predominant color. Recheck the white bar until you get one of the meter readings mentioned on the previous page. Adjust the red, green, and blue drive controls until there is no predominant color and the meter reading is within the specified range.





Pattern	Help
Gray Bars	
Black	
White	
Red	
Green	
Blue	
White Grid	
Black Grid	
Focus	

3. Select White from the Pattern menu to display the all-white screen.
4. Hold a light meter or photometer against the center of the screen.

The screen luminance reading should be one of the following:

- 21 (foot candles) on light meter Model R77
- Upper end of 10 on the 10 through 18 scale of light meter Model L-248
- 21 (foot candles) on the red scale of light





meter Model 246.

- 25 fL (foot lamberts)
on a photometer



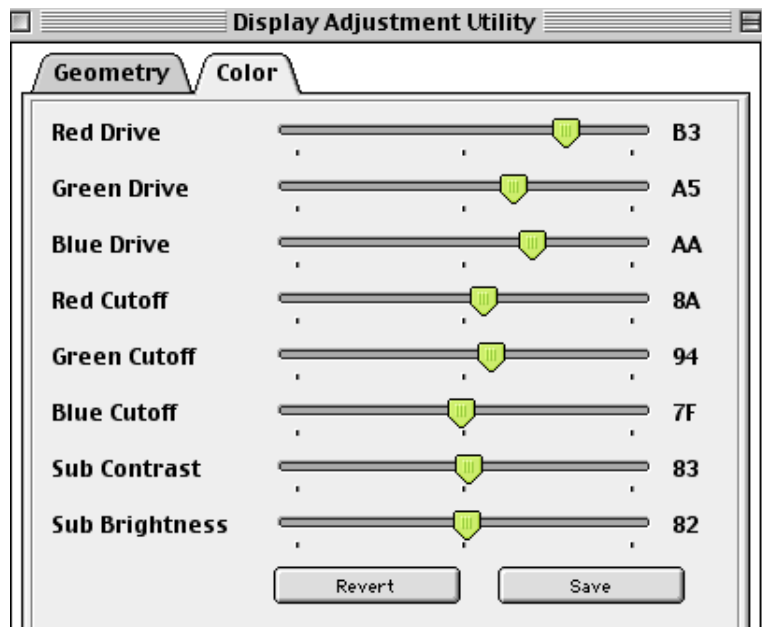

- Using the Color window, adjust the Sub Contrast slider to increase the screen brightness until the luminance measures correctly.
- Click the Save button in the Color window to save your settings.





Pattern	Help
Gray Bars	
Black	
White	
Red	
Green	
Blue	
White Grid	
Black Grid	
Focus	

Focus

1. Open the Display Service Utility and select Focus from the Pattern menu to display the focus test pattern.



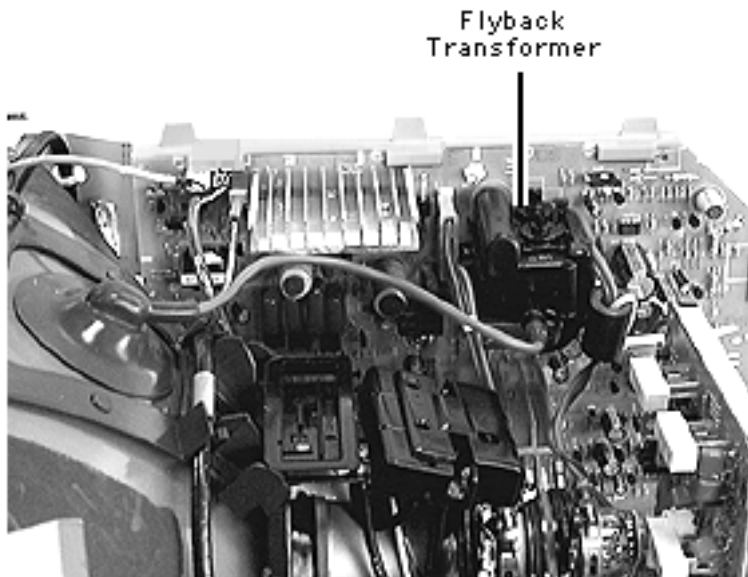

2. Using a flat-head plastic adjustment tool, adjust the focus control on the flyback transformer until the Focus test pattern reaches the best center-of-screen performance.





Upgrades

Power Macintosh G3

All-In-One





PCI or I/O Cards

Before you begin, remove the chassis carrier.

- 1 Remove the screw that holds the port access cover in place.
- 2 Remove the port access cover.

Note: If you remove all three port access covers, be sure the sheet metal shield remains under the edge of the logic board.

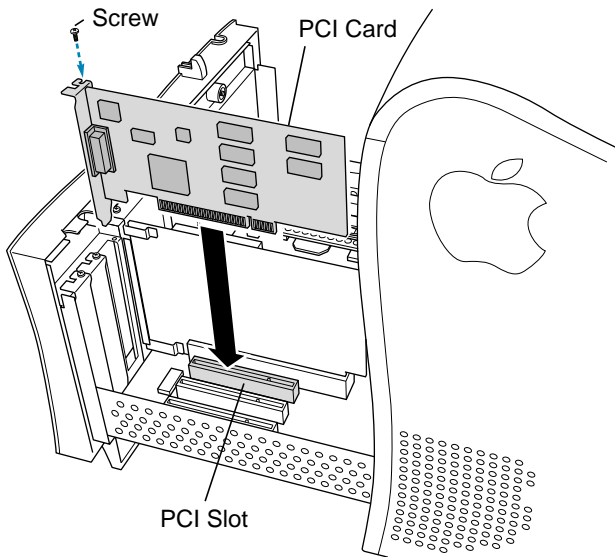

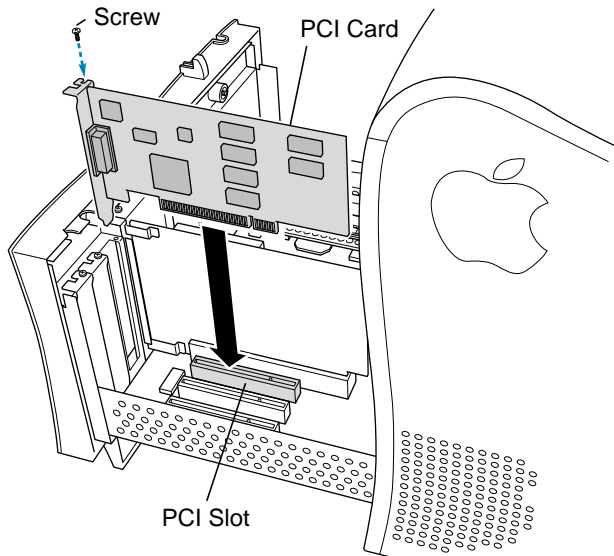

- 3 Align the card connector with the expansion slot and press straight down until the connector inserts all the way into the slot.





Memory—DRAM or VRAM

Before you begin, remove the

- Chassis carrier
- Cable clamp support bracket

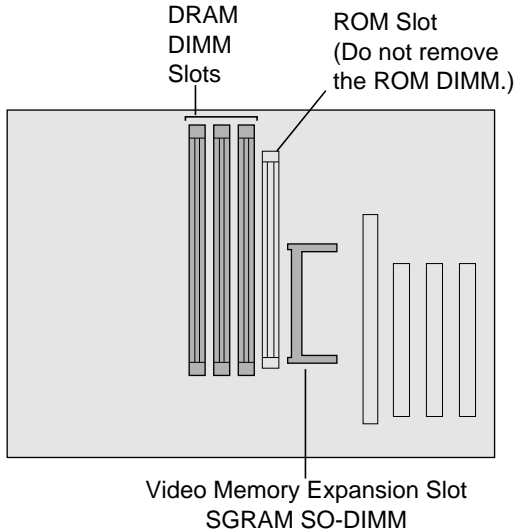



DRAM

Note: DIMM shape and components may vary.

- 1 To remove existing DRAM DIMMs to make room for new ones, push down on the ejectors.

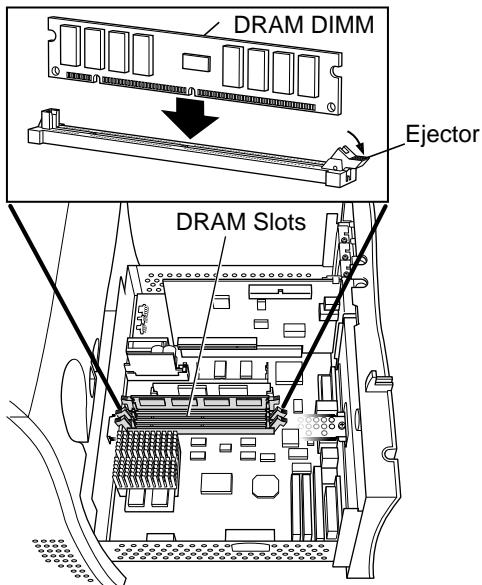

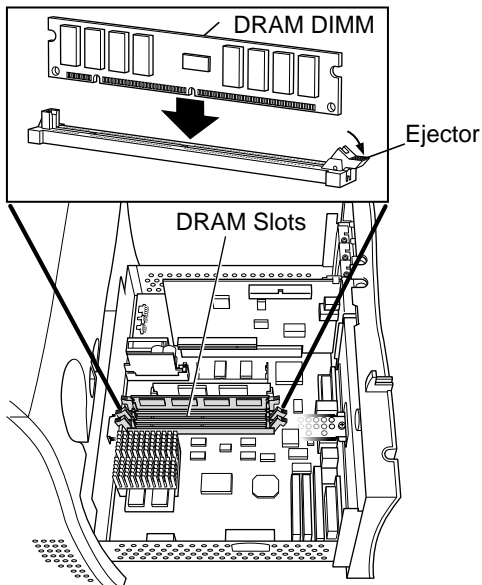

- 2 Align DIMM notches with DRAM slot ribs.

Note: The DIMM is designed to fit in the slot only one way.

- 3 With ejectors open, press the DIMM into the slot.

Note: Slot may have one or two ejectors.





VRAM

Note: SGRAM DIMM shape and components may vary.

- 1 To remove existing SGRAM DIMM, spread arms of video memory slot apart slightly. The SGRAM DIMM will pop up.

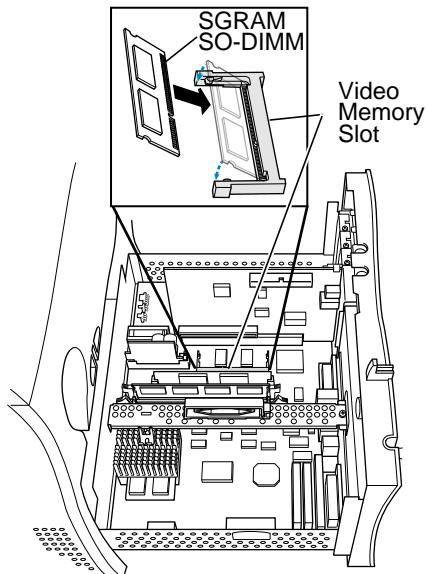

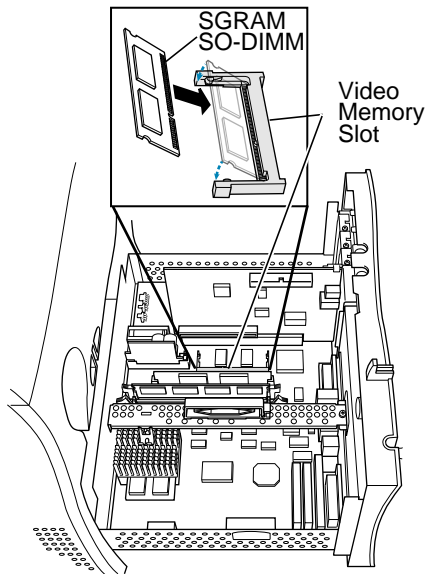

- 2 Align SGRAM DIMM notches with VRAM slot ribs.

Note: SGRAM DIMM fits into slot only one way.

- 3 Press the SGRAM DIMM into the slot.

Note: SGRAM DIMM should be flat and parallel to the logic board.





Modem Installation

Before you begin, do the following:

- Remove the chassis carrier
- Remove the I/O card

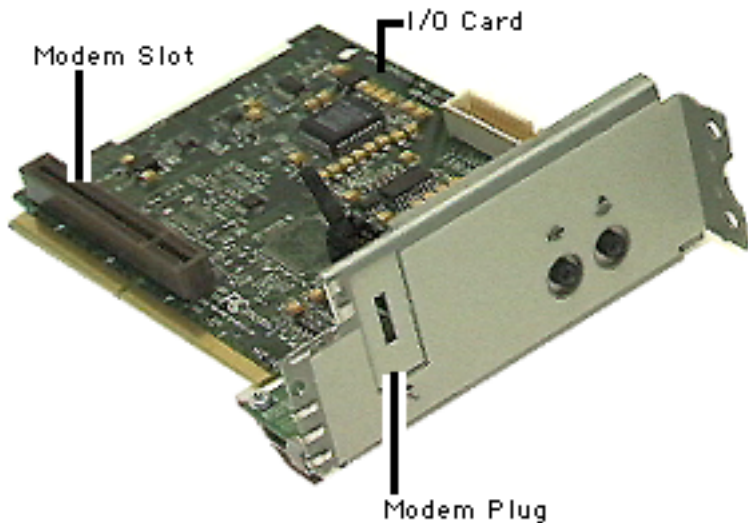



- 1 With a jewelers screwdriver, remove the modem port plug on the I/O card.

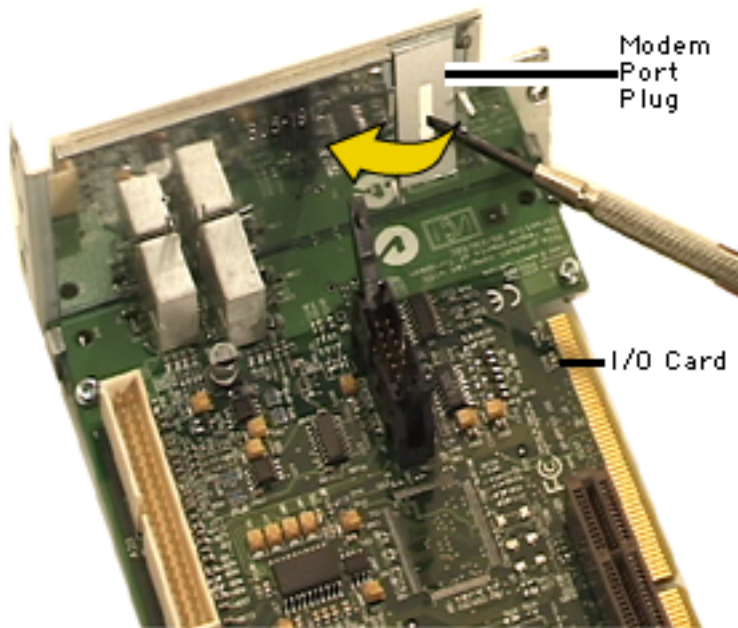



- 2 Align modem card with the modem slot. Push card firmly into the slot.

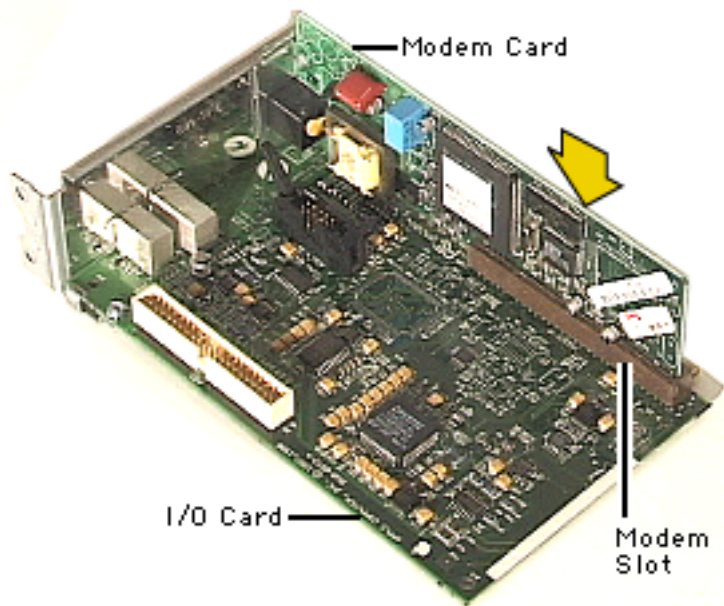

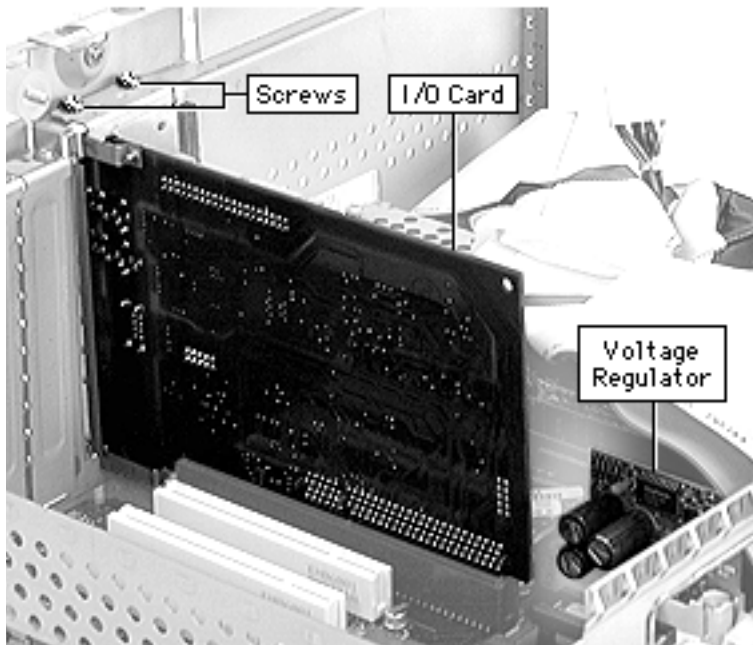

- 3 Reinstall the I/O card into the PERCH slot on the logic board. Be careful not to break the voltage regulator.
- 4 Connect the two cables on the I/O card.
- 5 Attach the two screws that secure the card to the chassis.





- 6 Push the chassis carrier into the unit.
- 7 Tighten the four screws on the back of the chassis carrier.

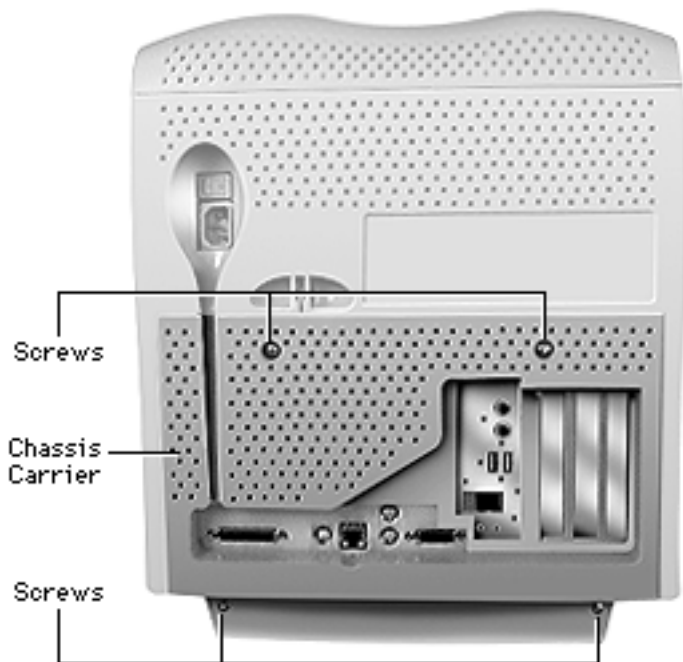



Additional Procedures

Power Macintosh G3
All-in-One





Adding a Zip Drive

There may be requests to add a zip drive to a Power Mac G3 All-in-one computer. Some prebuilt and build-to-order configurations do not include a zip drive. Therefore, customers may want to upgrade their systems by installing a zip drive taken from another computer, or by purchasing the individual service parts.

Note: If a customer wants a zip drive from another computer installed in their All-in-one, make sure to remove any cables and mounting brackets, and make sure to install the All-in-one EMI shield (part number 922-3525). The zip drive cables are already in place and ready to use.

See the following pages for instructions.



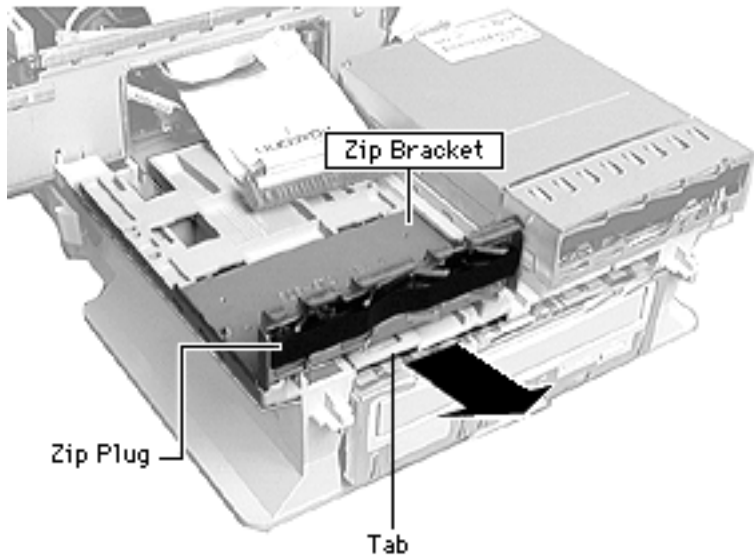

Before you begin, remove the chassis carrier (see the Take-Apart procedures).

- 1 Pull up on the release tab and remove the Zip drive carrier from the unit.

Note: When there is no Zip drive installed, the carrier has a Zip plug and Zip bracket attached to the carrier. You must remove these to install a Zip drive.



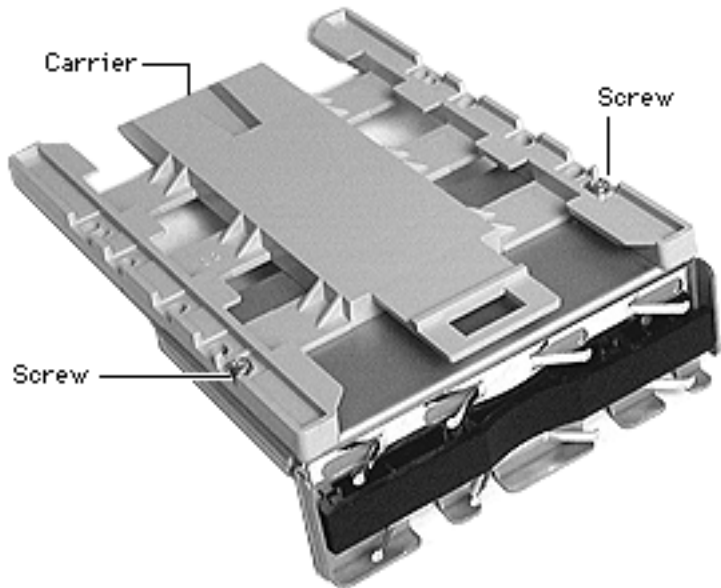

- 2 Flip the carrier over and remove the two screws that hold the Zip bracket on the carrier.
- 3 Screw the zip drive to the carrier, slide the carrier into place, and connect the cables.
- 4 Attach the zip EMI shield, part number 922-3525.
- 5 Replace chassis carrier.
- 6 Connect remaining internal cables, power on, and test the unit.





Exploded View

Power Macintosh G3
All-In-One



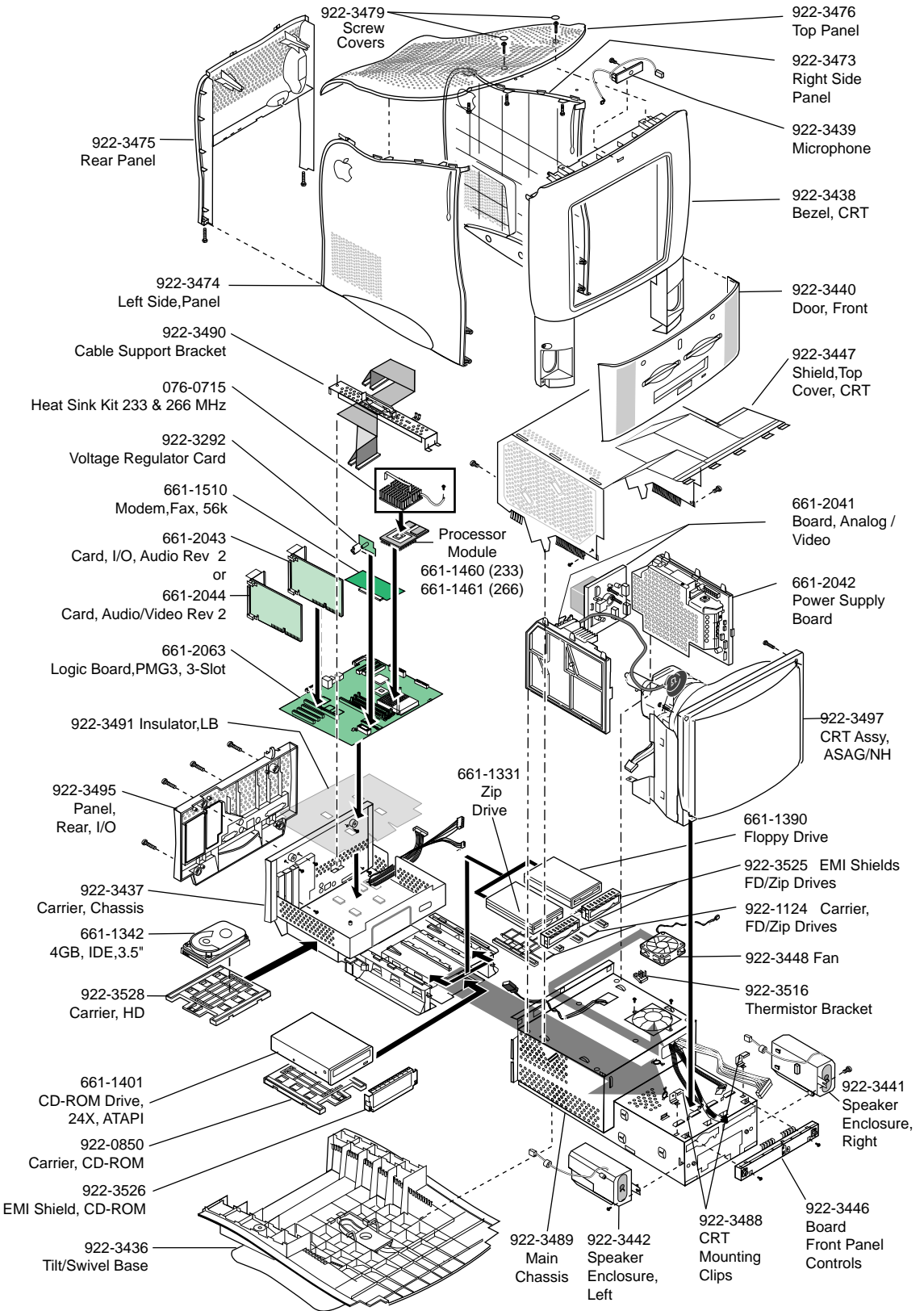

Note: for cable see G3 EV 2, and screw Identification see EV Screw Matrix





Cables Exploded View

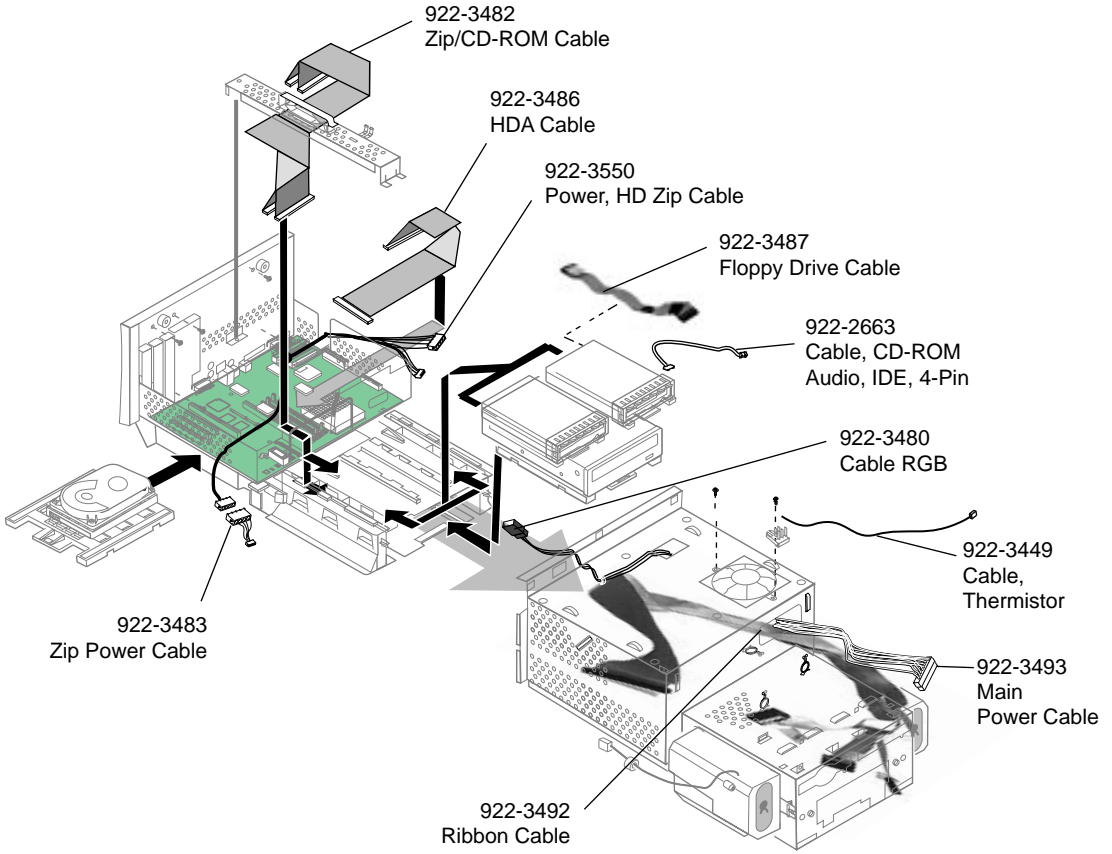

Power Macintosh G3 (All-in-One) EV 2- Carrier Chassis & Main Chassis Cables





Screw Matrix Exploded View

SCALE 1"=1"

Power Macintosh G3 (All-in-One) Screw Matrix

- (922-3538) Housing Panel Screws (10)
- (922-3546) I/O Door (Bottom Drawer) (2)
- (922-3542) CRT Bezel front(4), Top Housing (2), CRT Metal Frame to Bezel (4)
- (922-1382) Carrier for Floppy/Zip Screws (4 per device), Zip Plug & shield -if installed (2)
- (922-3544) Fan (2)
- (922-3537) I/O Plastic Panel (from inside) to Metal Chassis (5)
- (922-3259) I/O Card on Exterior (1), Cable Support Bracket (1), I/O Card to Chassis (2), Logic Board (2)
- (922-3543) CRT Clips (2), EMI Shield (5), Back of CRT (2), PCI Covers (3)
- (922-3540) Thermistor Bracket (1)
- (922-3539) Front Panel Board (2), Speakers, (2)
- (922-3541) Microphone (1)
- (922-3536) Tilt Swivel Base (2)

