



Power Macintosh 8200 and 8500 Series/WS 8550

Power Macintosh 8200 Series (Europe Only), 8500
Series, and WS 8550 Series





Basics

Power Macintosh 8200 and 8500
Series/WS 8550 Series





Overview

This manual covers the Power Macintosh 8200 Series (available only in Europe), the Power Macintosh 8500 Series, and the WorkGroup Server 8550 Series computers. These computers all share the same form factor as the earlier Power Macintosh 8100.

Power Macintosh 8200 Series

The Power Macintosh 8200 Series computers are available only in Europe. There are two versions of the Power Macintosh 8200, the Power Macintosh 8200/100 and the 8200/120. Features of the Power Macintosh 8200 Series include

- A 100 or 120 MHz PowerPC™ 601 microprocessor on the logic board with built-in FPU and 32K on-chip cache





- 256K level 2 cache
- 16 MB of DRAM, expandable to 256 MB
- Three PCI expansion slots
- SCSI DMA bus that supports up to four external and three internal SCSI devices
- Built-in AAUI and 10BASE-T Ethernet support
- Support for AppleTalk and TCP/IP networking protocols
- Two GeoPort serial ports
- AppleCD™ 600i 4x CD-ROM drive
- 16-bit stereo sound input/output
- 1 MB of soldered VRAM
- Mac™ OS system software 7.5.3





Power Macintosh 8500/WS 8550

The Power Macintosh 8500 and Workgroup Server 8550 feature three PCI expansion slots, a removable 604 microprocessor card, and, in addition, the Power Macintosh 8500 features video in and out functionality standard.

The list of features for the Power Macintosh 8500 includes

- A 120, 132, 150, or 180 MHz PowerPC™ 604 microprocessor card with built-in FPU and 32K on-chip cache
- Three PCI expansion slots
- One Digital Audio Video (DAV) slot
- 10 MB per second internal SCSI channel, 5 MB per second external SCSI channel
- 256 K Level 2 cache
- DRAM expansion up to 512 MB using 168-pin, 70 ns, 64-bit DIMMs





- 2 MB of VRAM, expandable to 4 MB
- 24-bit composite and S-video input and output
- Built-in AAUI and 10BASE-T Ethernet
- Two GeoPort serial ports
- AppleCD™ 600i 4x CD-ROM drive or 1200i 8x CD-ROM drive (8500/150 8x CD and 8500/180)
- 1.4 MB floppy drive
- CD-quality stereo sound in/out
- Mac™ OS system software 7.5.2 (8500/120) or 7.5.3 (8500/132 and 8500/150) or 7.5.3 Revision 2 (8500/150 8x-CD and 8500/180)

The list of features for the Workgroup Server 8550 Series computers includes

- A 132 MHz or 200 MHz PowerPC™ 604 microprocessor card with built-in FPU and 32K on-chip cache
- 512K Level 2 cache





- 24 MB of DRAM, expandable to 512 MB using 168-pin, 70 ns, 64-bit DIMMs
- Two SCSI DMA buses supporting up to eight SCSI devices and transfers up to 10 MB/s (internal bus only)
- Three PCI expansion slots
- Built-in AAUI and 10BASE-T Ethernet
- Two GeoPort serial ports
- AppleCD™ 600i or 1200i CD-ROM drive
- 2 GB hard drive, with bracket and cable for a second drive (support for array drives)
- DDS-2 DAT drive (optional)
- 1.4 MB floppy drive
- CD-quality stereo sound in/out
- Built-in 2 MB VRAM display support
- Support for TCP/IP networking software with Apple Open Transport
- Mac™ OS system software 7.5.3 (8550/132) or 7.5.3 Revision 2 (8550/200)





Configurations

The Power Macintosh 8500/120 comes standard with

- 120 MHz PowerPC 604 microprocessor card
- 16 MB of DRAM
- 256K Level 2 cache DIMM
- 1 GB or 2 GB hard drive
- AppleCD 600i CD-ROM drive
- 2 MB of VRAM

The Power Macintosh 8500/132, 8500/150, and 8500/180 come standard with

- 132, 150, or 180 MHz PowerPC 604 microprocessor card
- 16 MB of DRAM (8500/132) and 16 or 32 MB of DRAM (8500/150 and 8500/180)
- 256K Level 2 cache DIMM





- 1.2 GB or 2 GB hard drive
- AppleCD 600i 4x CD-ROM drive (8500/120, 8500/132, and 8500/150) or 1200i 8x CD-ROM drive (8500/150 8x-CD and 8500/180)
- 2 MB of VRAM

The WS 8550/132 and 8550/200 come standard with

- 132 MHz (8550/132) or 200 MHz (8550/200)
PowerPC 604 microprocessor card
- 24 MB of DRAM
- 512K Level 2 cache DIMM
- 2 GB hard drive
- AppleCD 600i (8550/132) or 1200i (8550/200)
CD-ROM drive
- 2 MB of VRAM





PowerPC 601 Microprocessor

The Power Macintosh 8200 Series computers feature the PowerPC 601 RISC microprocessor built onto the logic board. Features of this microprocessor include

- Full RISC processor architecture
- 32-bit addressing
- 64-bit data bus
- Built-in FPU
- 32K cache for data and instructions
- Internal Memory Management Unit (MMU)
- Advanced branching techniques for improved throughput





PowerPC 604 Microprocessor

The Power Macintosh 8500 and WS 8550 computers feature the PowerPC 604 RISC microprocessor. The PowerPC 604 microprocessor is installed via a card that plugs into the logic board, allowing for maximum flexibility with future upgrades.

Features of this microprocessor include

- Full RISC processing architecture
- Parallel processing units: one load-store unit, two integer units, one complex integer unit, and one floating point unit
- Separate built-in caches for data and instructions, 16 KB each, four-way set associative
- Advanced branching techniques for improved throughput





Peripheral Component Interconnect (PCI)

The Power Macintosh 8200 Series, Power Macintosh 8500 Series, and WS 8550 computers offer a Peripheral Component Interconnect (PCI) expansion bus. Because the PCI bus is an industry standard, most existing PCI 2.0-compliant cards (with the addition of a Mac OS-specific software driver) will work in these computers.

PCI offers significantly higher performance than the NuBus architecture used in previous Macintosh models. Running at 33 MHz, the PCI bus is up to three times faster than NuBus, offering overall enhanced system performance, particularly in the areas of video and networking.





Dual In-Line Memory Modules (DIMMs)

The Power Macintosh 8200 Series, Power Macintosh 8500 Series, and WS 8550 computers use DRAM Dual In-Line Memory Modules (DIMMs) instead of DRAM SIMMs. Whereas SIMMs have 72 pins, DIMMs have 168 pins. The extra pins provide a 64-bit data path, compared to a 32-bit data path for SIMMs. In addition, DIMMs do not have to be installed in pairs like the SIMMs on earlier Macintosh models. (However, to take advantage of memory interleaving, the DIMMs should be installed in paired slots. See "Memory Configurations" in Basics for more information.)

Important: The Single In-Line Memory Modules (SIMMs) used in previous Macintosh models are **not** compatible with these computers.





Important: These computers also use VRAM DIMMs (112-pin 70 ns or faster) instead of VRAM SIMMs. The VRAM SIMMs used in earlier Power Macintosh models are **not** compatible.

Memory Configurations

Following is the memory configuration information for the computers covered in this manual.

Power Macintosh 8200 Series

The Power Macintosh 8200 Series logic boards have four DRAM DIMM slots, each with a 64-bit data bus. You can increase the computer's DRAM to a total of 256 MB using 5-volt, 64-bit-wide, 168-pin fast-paged mode, 70 ns DIMMs.





Note: These computers do not have any main memory soldered to the logic board. At least one DRAM DIMM must be present for the computer to operate.

DRAM DIMMs can be installed individually or in pairs. These computers support linear memory only; therefore, no memory gains are seen when two DIMMs of the same size are installed (that is, memory interleaving is not supported on the Power Macintosh 8200 Series computers).

Note: DIMMs purchased from different manufacturers can be paired; However, Apple recommends that you use DIMMs of the same size and speed.

The drawing on the next page illustrates where the DRAM slots are located on the Power Macintosh 8200 Series logic boards and how they are numbered. DRAM can be installed in any order.



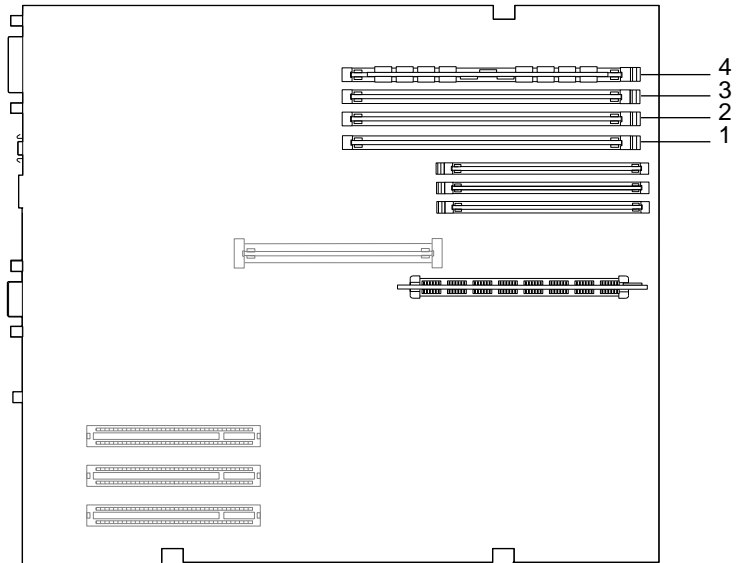

Figure: PM 8200 Series DRAM DIMM Slots





Power Macintosh 8500 Series/WS 8550

The Power Macintosh 8500 and WS 8550 logic boards have eight DRAM DIMM slots, each with a 64-bit data bus. You can increase the DRAM to a total of 512 MB using 5-volt, 64-bit-wide, 168-pin fast-paged mode, 70 ns DIMMs.

Note: These computers do not have any main memory soldered to the logic board. At least one RAM DIMM must be present for the computers to operate. DRAM DIMMs can be installed individually; however, if you wish to take advantage of the computer's interleaving* capability, which provides maximum performance, you must install the DIMMs in matching pairs and in paired slots (A4 and B4, A3 and B3, and so on).

* Memory interleaving allows the computer to read or write to its memory while other memory reads or writes are occurring, thus providing for faster performance.





For a pair of DIMMs to function as a single 128-bit wide pair, they must be the same type and size.

Note: DIMMs purchased from different manufacturers can be paired as long as they are the same size and speed.

The drawing on the next page illustrates where the DRAM slots are located on the Power Macintosh 8500 and WS 8500 logic boards and how they are numbered.



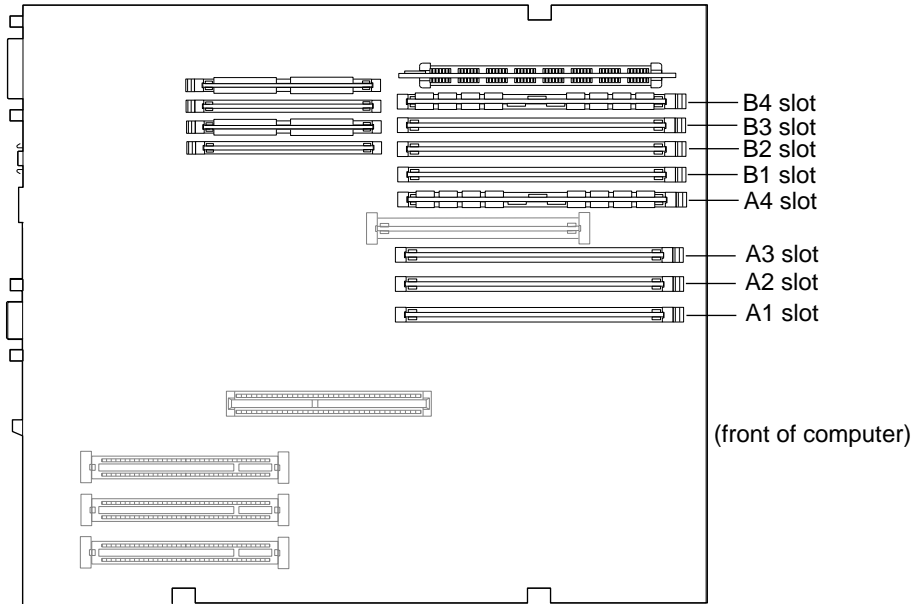

Figure: PM 8500 and WS 8550 DRAM DIMM Slots





Ethernet Support

There are two Ethernet ports on the Power Macintosh 8200, Power Macintosh 8500, and WS 8550 logic boards: an AAUI port and a 10BASE-T port. You can use only one Ethernet port at one time, however. If you have cables plugged into both Ethernet ports, the computer uses the 10BASE-T port by default.

AV Support

The Power Macintosh 8500 comes standard with an AV module that provides support for: composite video input and output, S-video input and output, audio input (left and right), and audio output (left and right).





GeoPort

Geoport is a hardware and software communications architecture that has been optimized for computer-telephony integration. It has three main attributes:

- It lets any computer connect to any telephone (analog or digital, public or private) anywhere in the world.
- Once connected, it supports an arbitrary number of independent data streams up to a total bandwidth of 2 MB/second.
- Unlike traditional asynchronous data communications (such as AppleTalk), GeoPort also supports isochronous data streams (such as real-time voice and video) and provides the real-time Application Program Interfaces (APIs) necessary to hide the implementation details from both the recipient and the sender.





By attaching an Apple GeoPort Telecom Adapter to these computers, you can enjoy all the features of a 14.4 modem, including data, fax, send and receive, and voice capabilities. The GeoPort Telecom Adapter serves as a line interface to standard (analog) telephone lines. The adapter is capable of sending or receiving data at up to 14.4 kbps and faxes at up to 9600 bps using the GeoPort Telecom Adapter software.

PC Compatibility Cards

Apple computer offers two PC Compatibility Card upgrade kits that bring full DOS functionality to the Macintosh computer. Two versions of the PC Compatibility card are available: a 7" card and a 12" card. The cards plug into any available PCI slot on the logic board. Refer to the Upgrades chapter in this manual for installation instructions.





The Cuda Chip

The Cuda is a microcontroller chip. Its function is to

- Turn system power on and off
- Manage system resets from various commands
- Maintain parameter RAM (PRAM)
- Manage the Apple Desktop Bus (ADB)
- Manage the real-time clock

Many system problems can be resolved by resetting the Cuda chip (see Symptom Charts for examples). Press the Cuda reset button on the logic board to reset the Cuda chip. (See "Logic Board Diagram" later in this chapter to locate the Cuda reset button.) If you continue to experience system problems, refer to "Resetting the Logic Board" later in this Basics chapter.





Resetting the Logic Board

Resetting the logic board can resolve many system problems (refer to "Symptom Charts" for examples). Whenever you have a unit that fails to power up, you should follow this procedure before replacing any modules.

- 1 Unplug the computer.
- 2 Remove the logic board. (Refer to the Take Apart chapter for instructions on how to remove the logic board.)
- 3 Using a small flat-blade screwdriver, pry open the latch at the end of the battery holder and lift off the battery holder cover.
- 4 Remove the battery from its holder.





- 5 Verify the power supply cable is disconnected from the logic board and then press the Power On button. (See "Logic Board Diagram" later in this chapter to locate the Power On button.)
- 6 Wait at least 10 minutes before replacing the battery. Make sure the battery is installed in the correct +/- direction.
- 7 Reassemble the computer and test the unit.

Note: This procedure resets the computer's PRAM. Be sure to check the computer's time/date and other system parameter settings afterwards.

Note: If this procedure resolves the problem, claim an adjustment on an SRO. If not, replace the defective component and DO NOT claim the adjustment procedure.





Fast SCSI

The Power Macintosh 8500 and WS 8550 computers offer Fast SCSI support on the internal SCSI connector, which provides for significantly enhanced data throughput. The internal SCSI bus on these computers supports transfer rates up to 10 MB/sec.





Rear View Diagram

The Power Macintosh 8200 and WS 8550 computers offer the following external ports: SCSI, AAUI and 10BASE-T Ethernet, serial printer (GeoPort compatible), serial modem (GeoPort compatible), DB-15 video, ADB, sound input, and sound output.

The drawing on the following page illustrates the back panel of the Power Macintosh 8200 and WS 8550 computers.



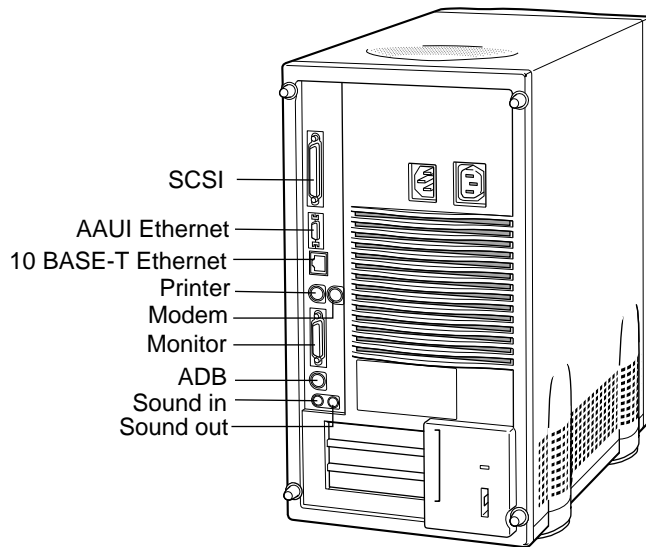

Figure: Power Macintosh 8200 and WS 8550 Rear Panel





In addition to the ports shown on the previous page, the Power Macintosh 8500 offers composite video input and output, S-video input and output, audio input (left and right), and audio output (left and right) ports.

The drawing on the following page illustrates the back panel of the Power Macintosh 8500 computer.



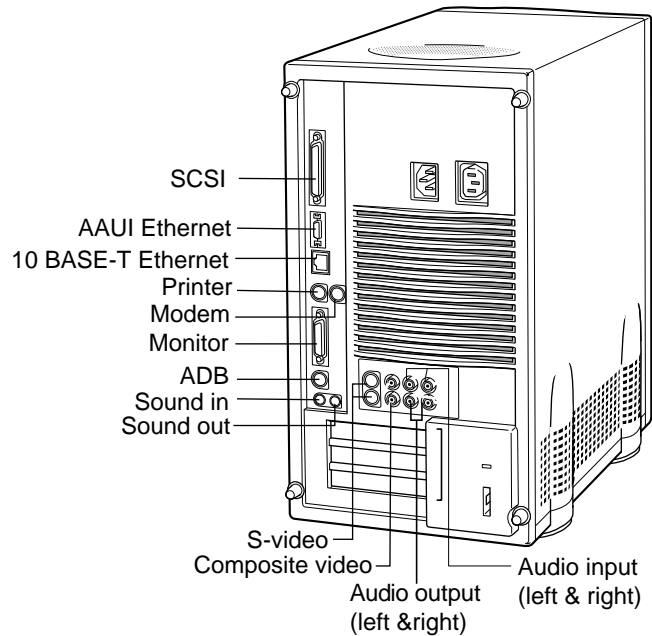

Figure: Power Macintosh 8500 Rear Panel





Logic Board Diagram

The following graphics illustrate the connectors on the Power Macintosh 8500, WS 8550, and Power Macintosh 8200 logic boards.

Note: Some versions of the logic board have a ROM SIMM while other versions have the ROM soldered on the logic board.



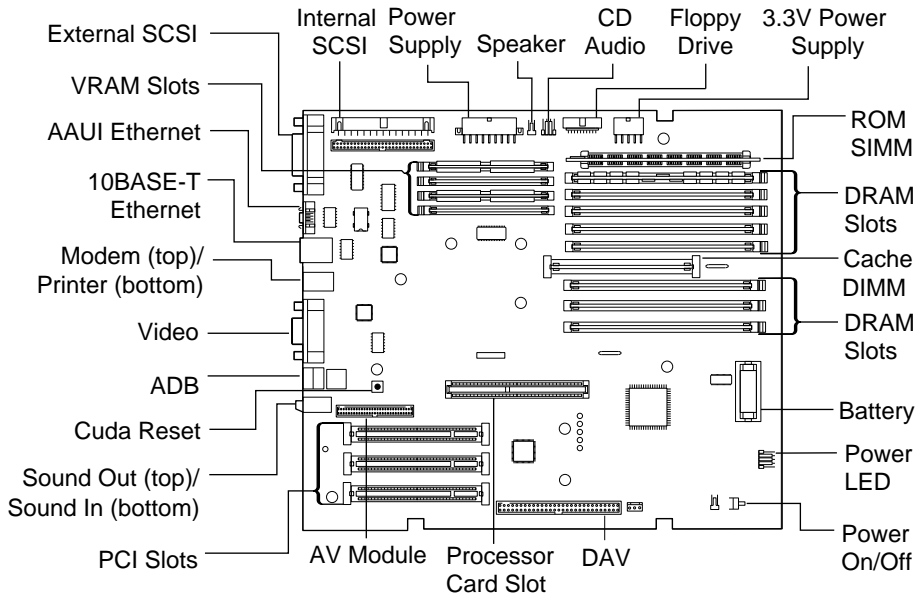

Figure: Power Macintosh 8500 Logic Board



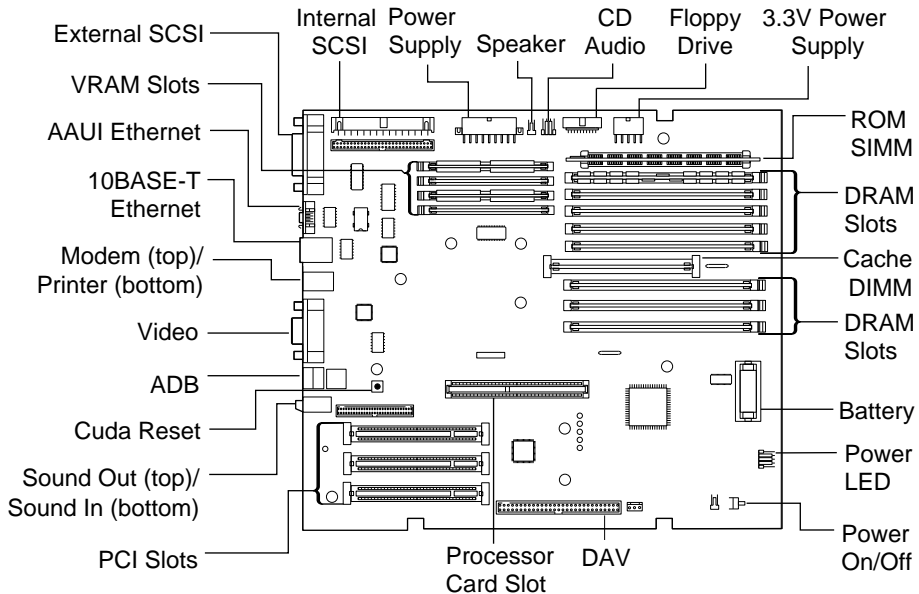

Figure: Workgroup Server 8550 Logic Board



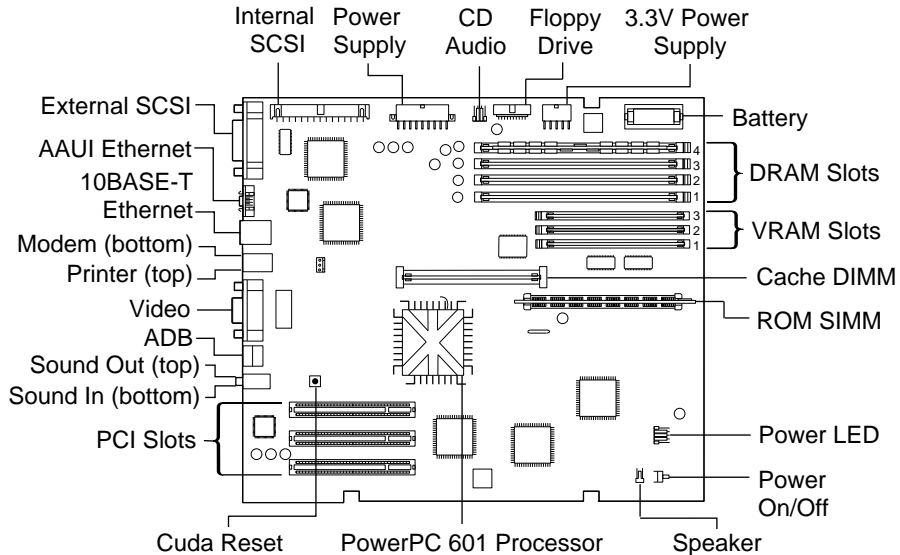

Figure: Power Macintosh 8200 Logic Board





Repair Strategy

Service the Power Macintosh 8500 and WS 8550 computers through module exchange and parts replacement. Customers can request on-site service from an Apple Authorized Service Provider Plus (AASP+) or Apple Assurance. They can also choose carry-in service from an AASP.

Ordering

Apple Service Providers planning to support the Power Macintosh 8500 and WS 8550 computers may purchase Service modules and parts to develop servicing capability. To order parts, use the AppleOrder system and refer to the Power Macintosh 8500 or Workgroup Server 8550 "Service Price Pages."





Large businesses, universities, and K-12 accounts must provide a purchase order on all transactions, including orders placed through the AppleOrder system. Service providers not enrolled in AppleOrder may fax their orders to Service Provider Support (512-908-8125) or mail them to

Apple Computer, Inc.
Service Provider Support
MS 212-SPS
Austin, TX 78714-9125

If you have further questions, please call Service Provider Support at 800-919-2775 and select option #1.





Warranty and AppleCare

The Power Macintosh 8500 and WS 8550 computers are covered under the Apple One-Year Limited Warranty. The AppleCare Service Plan is also available for these products. Service Providers are reimbursed for warranty and AppleCare repairs made to these computers. For pricing information, refer to "Service Price Pages."





Specifications

Power Macintosh 8200 and 8500
Series/WS 8550 Series





Processor

CPU

PM 8200

PowerPC 601 RISC microprocessor running at 100 or 120 MHz
Built-in FPU and 32K cache

Requires system software version 7.5.3 or later with appropriate
System Enabler

PM 8500

PowerPC 604 RISC microprocessor running at 120, 132, 150 or
180 MHz

Built-in FPU and 32K cache

Requires system software version 7.5.2 or later (8500/120),
7.5.3 or later (8500/132 and 8500/150) with appropriate
System Enabler, and 7.5.3 Revision 2 (8500/150 8x-CD and
8500/180)





WS 8550

PowerPC 604 RISC microprocessor running at 132 or 200 MHz

Built-in FPU and 32K cache

Requires system software version 7.5.3 or later with appropriate
System Enabler (8550/132) or 7.5.3 Revision 2 or later
(8550/200)





Memory

DRAM

**PM 8200/100 and
8200/120**

8 MB or 16 MB standard; expandable to 256 MB
Uses 168-pin, 64-bit, 70 ns or faster DRAM DIMMs

**PM 8500/120 and
8500/132**

16 MB standard; expandable to 512 MB
Uses 168-pin, 64-bit, 70 ns or faster DRAM DIMMs

**PM 8500/150 and
8500/180**

16 or 32 MB standard; expandable to 512 MB
Uses 168-pin, 64-bit, 70 ns or faster DRAM DIMMs

WS 8550

24 MB standard; expandable to 512 MB
Uses 168-pin, 64-bit, 70 ns or faster DRAM DIMMs





ROM	4 MB ROM (may be installed in ROM SIMM slot, or soldered on the logic board)
Cache	
PM 8200	256K Level 2 cache DIMM
PM 8500	256K Level 2 cache
WS 8550	512K Level 2 cache
Clock/Calendar	CMOS custom circuitry with long-life battery





I/O Interfaces

SCSI

Dual-channel asynchronous SCSI interface; external channel supports up to seven SCSI devices

**PM 8500 and
WS 8550**

Internal channel supports a hard disk array

Serial

Two RS-232/RS-422 serial ports compatible with LocalTalk and GeoPort cables; mini DIN-8 connectors

ADB

One Apple Desktop Bus port for a keyboard, mouse, etc.

Ethernet

One AAUI and one 10BASE-T Ethernet port (if cables are plugged into both ports, system defaults to 10BASE-T)





Expansion

Three PCI expansion slots, compatible with all PCI 2.0 specification-compliant cards with the addition of Mac OS-specific software driver (not NuBus compatible)

Sound

16-bit stereo sound input and output ports

Video

PM 8500

Built-in DB-15 video connector on logic board
24-bit video input and output connectors on AV module





I/O Devices

Keyboard

Standard, extended, or adjustable keyboard; keyboard draws 25-80 mA, depending on model type

Mouse

ADB Mouse II; mouse draws up to 10 mA

Microphone

Apple PlainTalk microphone standard





Video Support

Table 1: PM8500 and WS 8550 Video Support

	PIXEL DEPTHS	
MONITOR DISPLAY SIZE	2 MB VRAM	4 MB VRAM
512 by 384	8, 16, 32	8, 16, 32
640 by 480	8, 16, 32	8, 16, 32
768 by 576	8, 16, 32	8, 16, 32
800 by 600	8, 16, 32	8, 16, 32
832 by 624	8, 16, 32	8, 16, 32
1024 by 768	8, 16	8, 16, 32
1152 by 870	8, 16	8, 16



**Table 1: PM8500 and WS 8550 Video Support**

	PIXEL DEPTHS	
MONITOR DISPLAY SIZE	2 MB VRAM	4 MB VRAM
1280 by 960	8	8, 16
1280 by 1024	8	8, 16





Disk Storage

Hard Drive

PM 8500

1, 1.2, or 2 GB fast internal SCSI hard drive

WS 8550

2 GB fast internal SCSI hard drive
Supports drive array with dual hard drive bracket

Floppy Drive

One Apple SuperDrive 1.4 MB floppy drive

CD-ROM Drive

One internal AppleCD 600i 4x CD-ROM drive or
1200i 8x CD-ROM drive





Electrical

Line Voltage	100—240 VAC, RMS single phase, automatically configured
Frequency	50—60 Hz, single phase
Maximum Power	DC Power: 225 W, not including monitor AC Power: 340 W maximum continuous; 520 W peak input





Physical

Dimensions

Height: 14 in. (35.6 cm)

Width: 7.7 in. (19.6 cm)

Depth: 15.75 in. (40.0 cm)

Weight

25 lb. (11.3 kg); weight varies depending on devices installed





Environmental

**Operating
Temperature**

50 to 104° F (10 to 40° C)

**Storage
Temperature**

—40 to 116° F (—40 to 47° C)

Relative Humidity

5% to 95% noncondensing

Maximum Altitude

10,000 ft. (3,048 m)





Troubleshooting

Power Macintosh 8200 and 8500
Series/WS 8550 Series





General

The Symptom Charts included in this chapter will help you diagnose specific symptoms related to your product. Because cures are listed on the charts in the order of most likely solution, try the first cure first. Verify whether or not the product continues to exhibit the symptom. If the symptom persists, try the next cure. (Note: If you have replaced a module, reinstall the original module before you proceed to the next cure.)

If you are not sure what the problem is, or if the Symptom Charts do not resolve the problem, refer to the Flowchart for the product family.

For additional assistance, contact Apple Technical Support.





Cleaning Procedure for Card Connectors

It is possible for residue to build up on the gold edge connector pins on some PCI cards, which could cause a variety of symptoms.

If you are having problems with a PCI card, inspect the connector pins with a magnifying glass. If you find residue, use a pencil eraser to gently clean the pins.





Symptom Charts

Power Supply

System doesn't power up

- 1 Reseat processor card and ROM SIMM (if present).
- 2 Reset Cuda chip. (Refer to The Cuda Chip in Basics for instructions.)
- 3 Reset logic board. (Refer to Resetting the Logic Board in Basics for instructions.)
- 4 Replace power supply.
- 5 Replace processor card.
- 6 Replace logic board.





Error Chords

One-part error chord sounds during startup sequence

- 1 Disconnect SCSI data cable from hard drive and reboot system. If startup sequence is normal, initialize hard drive. Test unit again with SCSI data cable connected. If error chord still sounds, replace hard drive.
- 2 Disconnect floppy drive cable from floppy drive and reboot system. If startup sequence is normal, replace floppy drive.
- 3 Reseat processor card.
- 4 Replace processor card.
- 5 Replace logic board. Retain customer's DIMMs.





Error Chords (Continued)

Eight-part error chord (death chimes) sounds during startup sequence

- 1 Replace DRAM DIMMs one at a time to test DRAM. Replace any faulty DIMMs.
- 2 Replace logic board.





System

Does not power on, screen is black, fan is not running and LED is not lit

- 1 Check power cables.
- 2 Plug monitor directly into wall socket, and verify that monitor has power.
- 3 Reseat ROM SIMM (if present) and processor card. The logic board must have a processor card installed to operate.
- 4 Reset Cuda chip. (Refer to The Cuda Chip in Basics for instructions.)
- 5 Reset logic board. (Refer to Resetting the Logic Board in Basics for instructions.)
- 6 Replace power cord.
- 7 Replace power supply.
- 8 Replace processor card.
- 9 Replace logic board. Retain customer's DIMMs.





System (Continued)

Clicking, chirping,
or thumping

- 1 Remove all PCI cards and test the unit. If problem does not occur with cards removed, begin replacing them one at a time to determine which card is causing the problem. Replace problem card with known-good card.
- 2 Remove hard drive. If problem no longer occurs, replace hard drive with a known-good drive.
- 3 Replace power supply.
- 4 Replace processor card.
- 5 Replace logic board. Retain customer's DIMMs.
- 6 Replace floppy drive cable.
- 7 Replace floppy drive.





System (Continued)

System shuts down
intermittently

- 1 Make sure air vents are clear. Thermal protection circuitry may shut down system. After 30 to 40 minutes, system should be OK.
- 2 Make sure power cord is firmly plugged in.
- 3 Replace power cord.
- 4 Check battery.
- 5 Reset Cuda chip. (Refer to The Cuda Chip in Basics for instructions.)
- 6 Reset logic board. (Refer to Resetting the Logic Board in Basics for instructions.)
- 7 Replace power supply.
- 8 Replace processor card.
- 9 Replace logic board. Retain customer's DIMMs.





System (Continued)

System
intermittently
crashes or hangs

- 1 Verify system software is version 7.5.2 or later (PM8500/120) or 7.5.3 or later (PM 8500/132, PM 8500/150, and WS 8550).
- 2 Verify DIMMs are noncomposite.
- 3 Verify software is known-good. Do a clean install of the system software.
- 4 Verify software is Power Macintosh 8500 compatible (contact developer). Also, try booting with extensions off to determine if there are system init problems.
- 5 Clear parameter RAM. Hold down <Command> <Option> <P> <R> during startup but before "Welcome to Macintosh" appears.
- 6 Remove all DRAM DIMMs and try replacing them one at a time to test. Replace any bad DIMMs.
- 7 Replace processor card.
- 8 Replace logic board. Retain DIMMs.





System (Continued)

During startup, following message is displayed, "This startup disk will not work on this Macintosh model...."

PM 8200 can't be powered off unless external 1.2 GB hard drive is off **or** LED remains lit when system is powered off and attached 1.2 GB hard drive is left powered on

- 1 Verify that startup disk is good.
- 2 Verify system software is version 7.5.2 or later (PM8500/120) or 7.5.3 or later (PM 8500/132, PM 8500/150, and WS 8550).
- 3 Do a clean install of the system software.

This problem only affects PM 8200 machines with serial numbers in the following ranges:

- CK634xxxxxx to CK637xxxxxx
- XB634xxxxxx to XB637xxxxxx
- SG634xxxxxx to SG637xxxxxx
- FC634xxxxxx to FC637xxxxxx
-

If system falls into one of these serial number ranges, execute the following instructions:





- 1) Unplug system and remove top cover.
- 2) Disconnect hard drive SCSI cable and power cable.
- 3) Remove hard drive from chassis.
- 4) Turn drive over and examine part number label on 50-pin SCSI connector (removing drive carrier if necessary). If label reads “1280S p/n TM12S012” **and** “REV 02-B”, replace drive.

Note: Only Revision “02” drives cause this problem; therefore, make sure bar code label includes the words “REV 02-B” before replacing hard drive.





Video

Screen is black, boot tone is present, drive operates, fan is running, and LED is lit

- 1 Adjust brightness on monitor.
- 2 Clear parameter RAM. Hold down <Command> <Option> <P> <R> during startup but before "Welcome to Macintosh" appears.
- 3 Reset Cuda chip. (Refer to The Cuda Chip in Basics.)
- 4 Reset logic board. (Refer to Resetting the Logic Board in Basics.)
- 5 Replace monitor cable.
- 6 Remove all DRAM DIMMs and try replacing them one at a time to test. Replace any bad DIMMs.
- 7 Test with known-good monitor. Replace monitor if necessary. Refer to appropriate monitor manual to troubleshoot defective monitor.
- 8 Replace processor card.
- 9 Replace logic board. Retain customer's DIMMs.





Video (Continued)

Screen is black, no boot tone and drive does not operate, but fan is running and LED is lit

- 1 Reset Cuda chip. (Refer to The Cuda Chip in Basics for instructions.)
- 2 Reset logic board. (Refer to Resetting the Logic Board in Basics for instructions.)
- 3 Remove all DRAM DIMMs and try replacing them one at a time to test. Replace any bad DIMMs.
- 4 Replace processor card.
- 5 Replace logic board. Retain customer's DIMMs.
- 6 Replace power supply.





Video (Continued)

Boot tone is present and screen lights up, but nothing is displayed on screen

- 1 Reset Cuda chip. (Refer to The Cuda Chip in Basics for instructions.)
- 2 Reset logic board. (Refer to Resetting the Logic Board in Basics for instructions.)
- 3 Replace monitor cable.
- 4 Test with known-good monitor. Replace monitor if necessary. Refer to appropriate monitor manual to troubleshoot defective monitor.
- 5 Replace processor card.
- 6 Replace logic board. Retain customer's DIMMs.





Video (Continued)

Video display distorted on Power Macintosh 8500 with DAV card installed

Symptom occurs when an add-in card attached to the DAV connector requires a mode configuration under which the add-in card controls most of the signal lines (Mode 2). Verify that the logic board installed supports DAV cards; if not, replace the logic board.

If the logic board in question meets **either** of the following criteria, then it **DOES** support DAV cards and you need not replace the board:

- Part number 820-0752 is silk-screened on the logic board.
- The Logic board has the wiring scenario shown on the next page.





NOTE: The dotted line indicates that the jumper wire is running underneath the logic board.

Jumper Wire

PCB Part Number

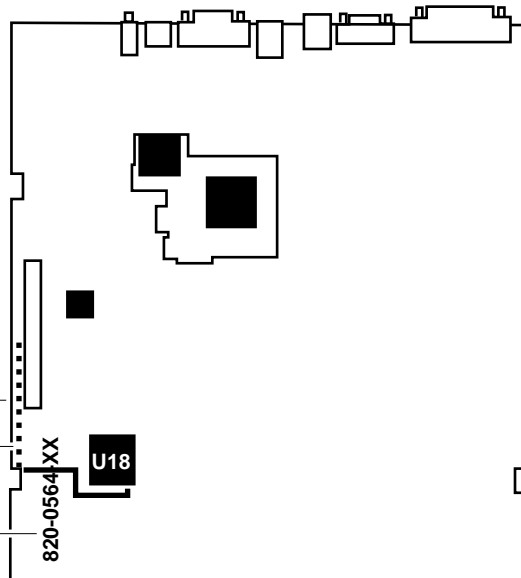

Power Macintosh 8500 Logic Board with DAV Fix





Floppy Drive

Internal floppy drive
does not operate

- 1 Replace floppy disk with known-good disk.
- 2 Replace floppy drive cable.
- 3 Replace floppy drive.
- 4 Replace processor card.
- 5 Replace logic board. Retain customer's DIMMs.

During system
startup, disk ejects;
display shows icon
with blinking "X"

- 1 Replace disk with known-good system disk.
- 2 Replace floppy drive cable.
- 3 Replace floppy drive.
- 4 Replace processor card.
- 5 Replace logic board. Retain customer's DIMMs.





Floppy Drive (Continued)

Does not eject disk

- 1 Switch off computer. Hold mouse button down while you switch computer on.
- 2 Replace floppy drive cable.
- 3 Replace floppy drive.
- 4 Replace processor card.
- 5 Replace logic board. Retain customer's DIMMs.

Attempts to eject disk, but doesn't

- 1 Reseat floppy drive bezel and drive so bezel slot aligns correctly with drive.
- 2 Replace floppy drive.





Floppy Drive (Continued)

Internal floppy drive runs continuously

- 1 Replace disk with known-good floppy disk.
- 2 Replace floppy drive cable.
- 3 Replace floppy drive.
- 4 Replace processor card.
- 5 Replace logic board. Retain customer's DIMMs.

MS-DOS drive does not recognize a disk formatted on a 1.4 MB drive

To read and write files with either MS-DOS or 1.4 MB drive, format all disks with MS-DOS drive first.





Hard Drive

Single internal hard drive does not operate; drive doesn't spin

- 1 Replace hard drive power cable.
- 2 Replace hard drive. If problem resolved, reinstall SCSI device driver and system software.
- 3 Replace power supply.

No internal SCSI drives operate

- 1 Verify there are no duplicate SCSI device addresses.
- 2 Disconnect external SCSI devices and check for proper termination. Only last device in SCSI chain should be terminated.
- 3 Replace SCSI data cable.
- 4 Replace power supply.
- 5 Replace processor card.
- 6 Replace logic board. Retain customer's DIMMs.





Hard Drive (Continued)

Drive does not appear on the desktop

- 1 Verify there are no duplicate SCSI device addresses.
- 2 Update the SCSI device driver using Drive Setup. Run Disk First Aid to verify the condition of the drive's directory structure.
- 3 Replace the SCSI hard drive cable.
- 4 If drive is not initialized, use Drive Setup to initialize.
- 5 Replace with known-good hard drive.
- 6 If the hard drive still doesn't work, switch back to the original hard drive and replace the logic board.





Hard Drive (Continued)

Works with internal or external SCSI devices but not with both

- 1 Verify there are no duplicate SCSI device addresses.
- 2 Replace terminator on external SCSI device.
- 3 Verify that SCSI device at end of internal SCSI data cable is only device terminated.
- 4 Refer to appropriate manual to troubleshoot defective external device.





Peripherals

Cursor does not move

- 1 Check mouse connection.
- 2 Inspect inside of mouse for buildup of dirt or other contaminants. Clean mouse if necessary.
- 3 If mouse was connected to keyboard, connect mouse to computer ADB port instead. If mouse works, replace keyboard.
- 4 Replace ADB cable.
- 5 If mouse does not work in any ADB port on computer, replace mouse.
- 6 Replace processor card.
- 7 Replace logic board. Retain customer's DIMMs.





Peripherals (Continued)

Cursor moves, but clicking mouse button has no effect

- 1 Boot from floppy or bootable CD.
- 2 Replace mouse.
- 3 Replace logic board. Retain customer's DIMMs.

Double-click doesn't open application, disk, or server

- 1 Remove duplicate system folders.
- 2 Clear parameter RAM. Hold down <Command> <Option> <P> <R> during startup but before "Welcome to Macintosh" appears.
- 3 If mouse was connected to keyboard, connect mouse to computer ADB port instead. If mouse works, replace keyboard.
- 4 If mouse does not work in any ADB port on computer, replace mouse.
- 5 Replace logic board. Retain customer's DIMMs.





Peripherals (Continued)

No response to any key on keyboard

- 1 Check keyboard connection to ADB port.
- 2 Replace keyboard cable.
- 3 Replace keyboard.
- 4 Replace logic board. Retain customer's DIMMs.

Known-good serial printer does not work

- 1 Verify you have correct version of system software.
- 2 Verify that Chooser is set correctly.
- 3 Reinstall correct printer drivers.
- 4 Do clean install of system software.
- 5 Replace printer interface cable.
- 6 Replace logic board. Retain customer's DIMMs.





Peripherals (Continued)

Known-good network
printer does not print

- 1 Check network connections.
- 2 Verify you have correct version of system software.
- 3 Verify that Chooser is set correctly.
- 4 Does printer show up in Chooser? If so, do clean install of system software and/or network and printer software.
- 5 Replace logic board. Retain customer's DIMMs.





CD-ROM Drive

CD-ROM drive does not work

- 1 Try using known-good compact disc.
- 2 Replace CD-ROM drive mechanism.

Macintosh does not display CD-ROM icon once CD is inserted in drive

- 1 Verify that CD-ROM software is installed.
- 2 Replace CD-ROM drive mechanism.
- 3 Replace SCSI data cable.

Computer with 600i CD-ROM drive makes stuttering sounds when playing CD+ or CD-R formatted discs or CD-ROM disc won't mount

Replace CD-ROM drive.





Miscellaneous

No sound from speaker

- 1 Verify that volume setting in Control Panel is 1 or above.
- 2 Clear parameter RAM. Hold down <Command> <Option> <P> <R> during startup but before "Welcome to Macintosh" appears. Verify speaker is plugged into logic board.
- 3 Replace speaker.
- 4 Replace logic board. Retain customer's DIMMs.





Errors occur when initializing or erasing floppy disks and/or 1.4 MB disks show only 1 MB available after initialization

This problem only occurs on systems using a 180 MHz or faster processor card. Upgrade to system software version 7.5.4 to resolve this problem (the Apple recommended solution) or, alternatively, install the Power Mac Format Patch, which can be found on the original system disks that shipped with the computer. To install the patch:

- While holding down the Option key, drag the Power Mac Format Patch icon onto the System Folder's icon.
- Click OK to automatically place the patch in the Extensions folder.
- Restart the computer by choosing Restart from the Special menu.





Take Apart

Power Macintosh 8500 Series/WS
8550 Series





Top Housing



Top Housing

No preliminary steps are required before you begin this procedure.

Note: The top housing covers the top, front, and left and right sides of the computer.

IMPORTANT: Never operate the computer with the top housing removed. Failure to comply may result in irreparable damage to internal components.





- 1 Loosen the four captive cover screws on the rear panel and slide the top panel and slide the top housing forward about one inch.





- 2 Lift the top housing straight up to remove it from the computer.





CD-ROM Drive

Before you begin, remove the top housing.

Note: The CD-ROM drive is located in the top drive bay.



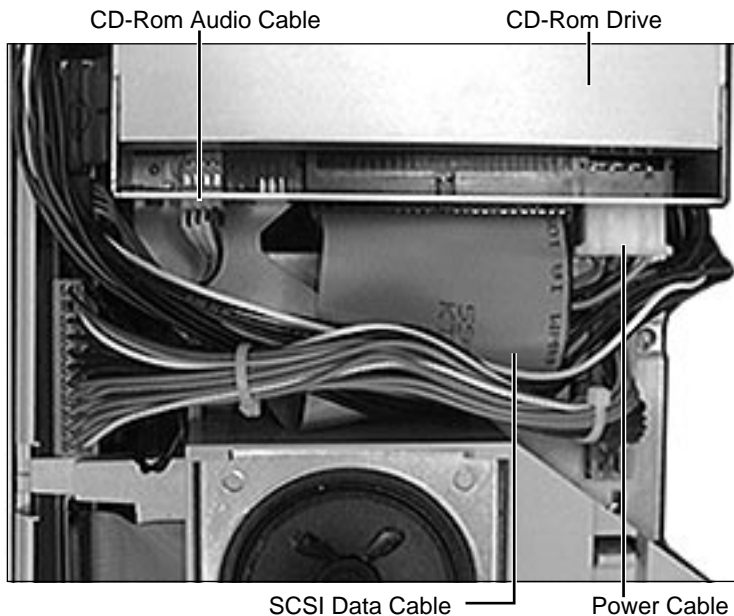

- 1 Disconnect the SCSI data cable, audio cable, and power cable from the back of the CD-ROM drive.



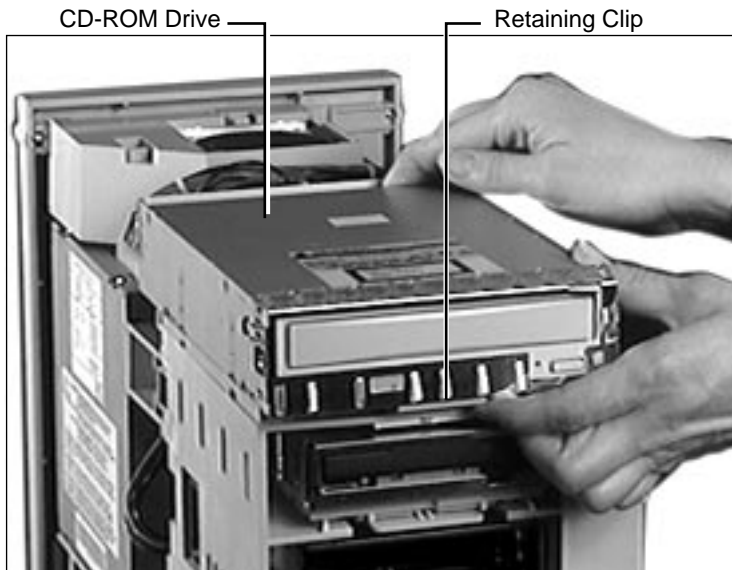

- 2 Pull up the retaining clip beneath the front of the CD-ROM drive and slide the drive forward to remove it from the computer.

Note: Be sure to remove the CD-ROM drive from its carrier before returning the drive to Apple.





Floppy Drive

Before you begin, remove the following:

- Top Housing
- CD-ROM Drive

Note: The floppy drive is located in the second drive bay from the top.



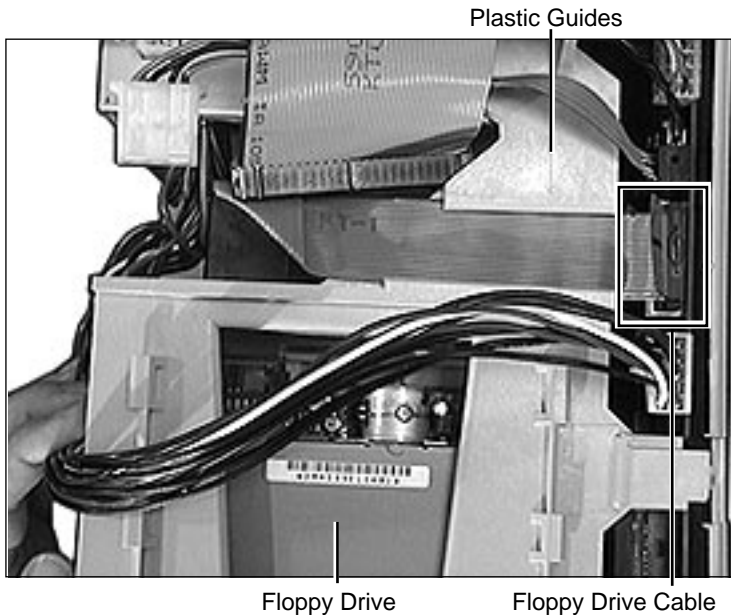

- 1 Disconnect the floppy drive cable from the logic board and remove the cable from the plastic guides.



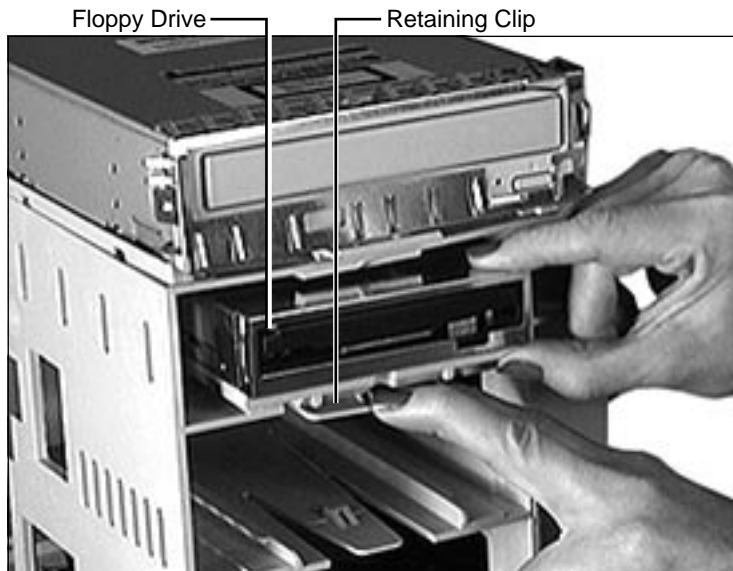

- 2 Press down the retaining clip beneath the front of the floppy drive and slide the floppy drive forward about two inches.
- 3 Disconnect the floppy drive cable from the back of the floppy drive and remove the floppy drive from the computer.

Replacement Note: Be sure to remove the floppy drive from its carrier before returning the drive to Apple.



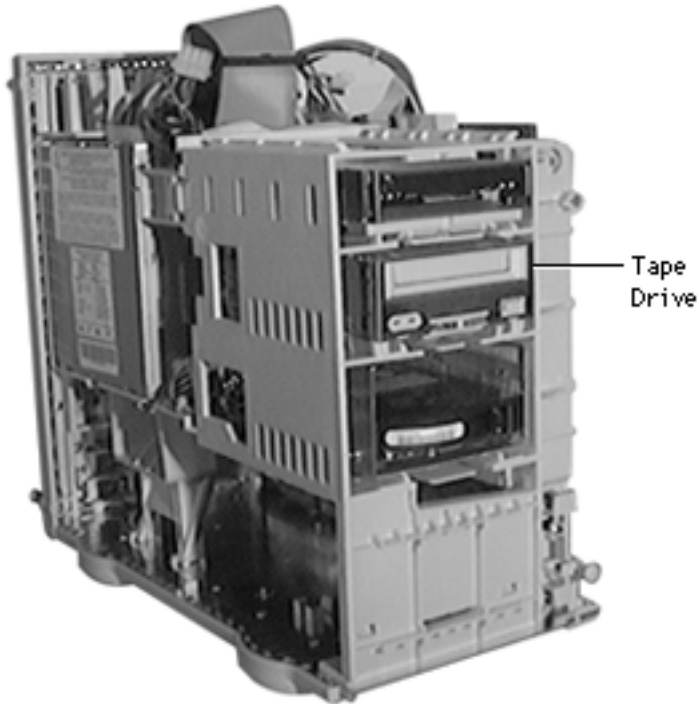

DAT Tape Drive-WS 8550

Before you begin, remove the top housing.

Note: The DAT tape drive is located in third drive bay from the top. The tape drive is optional on the WS 8550.





SCSI Cable



Power Cable

- 1 Disconnect the SCSI cable and power cable from the back of the tape drive.



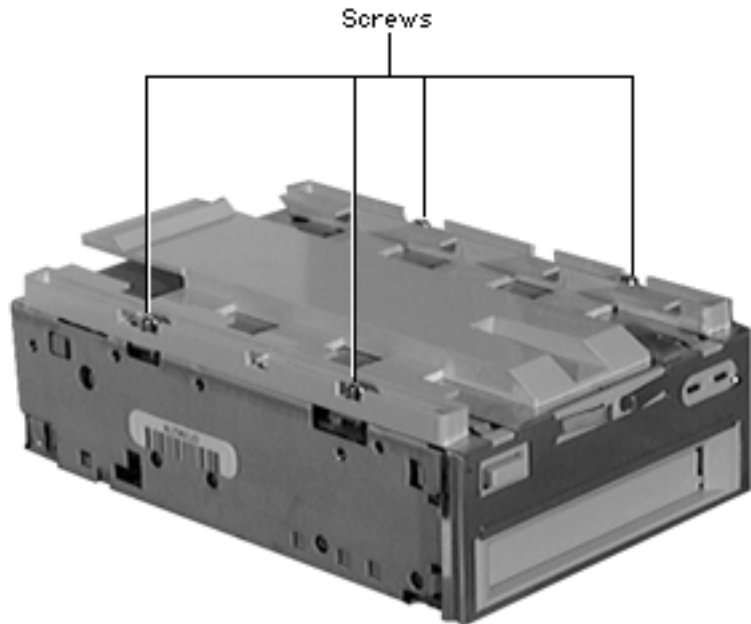

- 2 Remove the four screws securing the carrier to the tape drive. Remove the carrier before returning the tape drive to Apple.



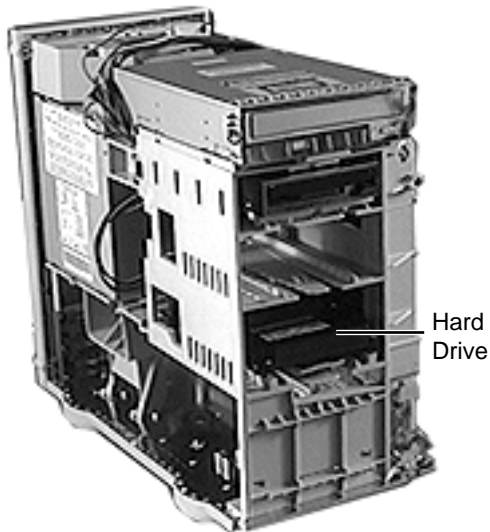

Hard Drive-Power Macintosh 8500

Before you begin, remove the top housing.

Note: The hard drive is located in the bottom drive bay.



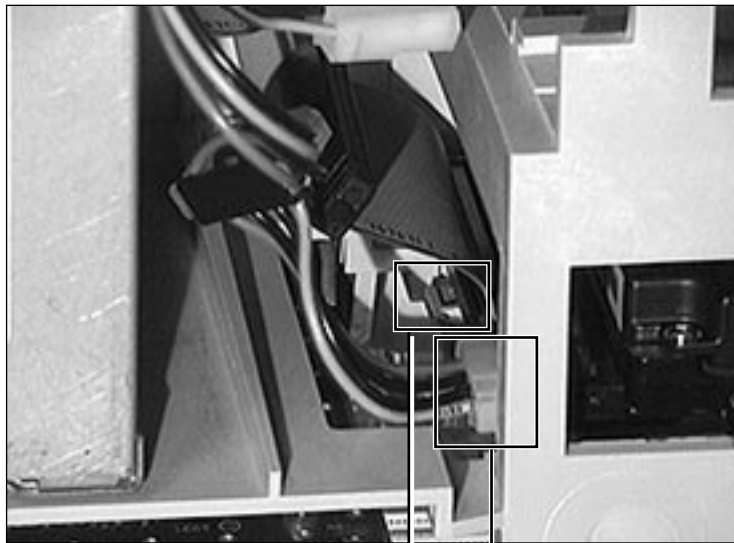

SCSI Cable

Power Cable

- 1 Disconnect the SCSI data cable and hard drive power cable from the hard drive.





Hard Drive

Retaining Clip

- 2 Press down the retaining clip beneath the front of the hard drive and slide the hard drive forward to remove it from the computer.

Note: For information on removing the hard drive from its carrier and returning drives, cables, and carriers to Apple, refer to Additional Procedures in the Hard Drives manual.





Hard Drive-WS 8550

Before you begin, remove the top housing.

Note: The Workgroup Server 8550 can hold up to two hard drives, which install in a metal drive bracket as opposed to the plastic drive carrier used in the Power Macintosh 8500.

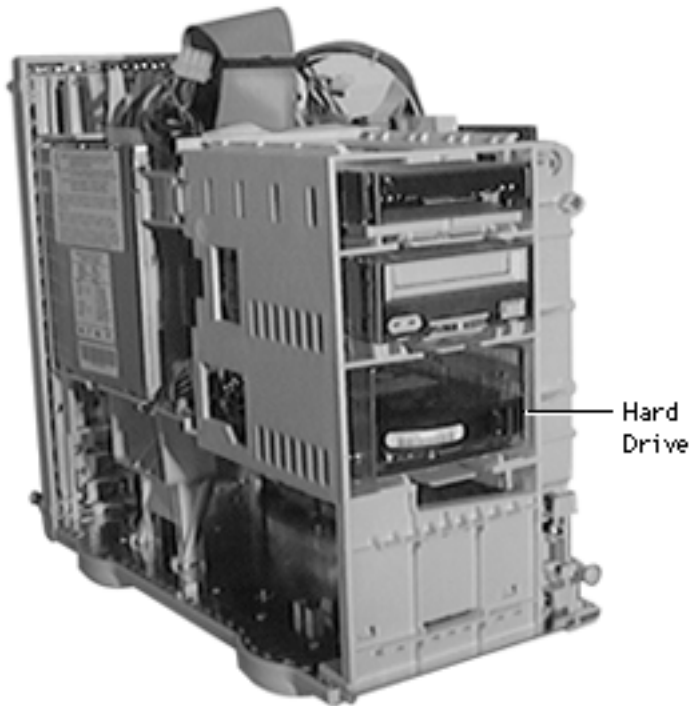



- 1 Press down the retaining clip beneath the front of the hard drive bracket and gently slide the hard drive bracket forward as far as it will reach.



Retaining Clip



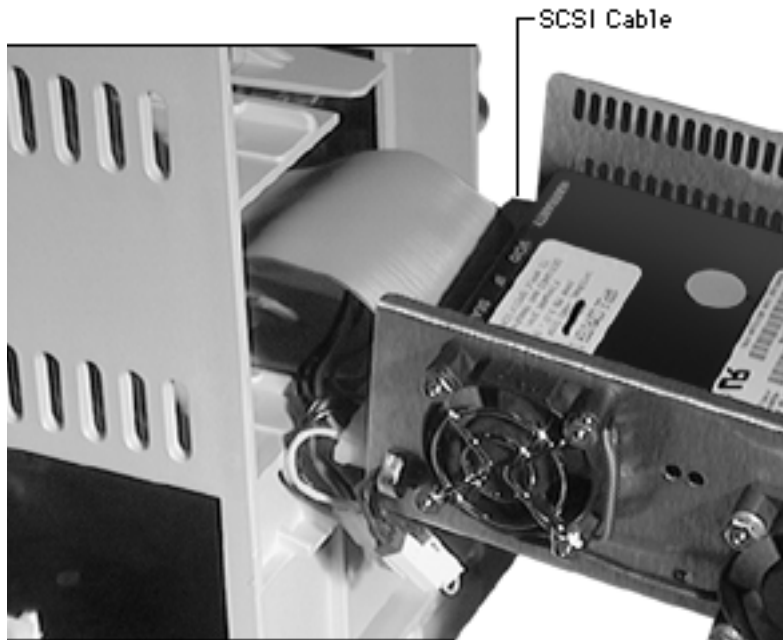

- 2 Disconnect the SCSI cable from the back of the hard drive.



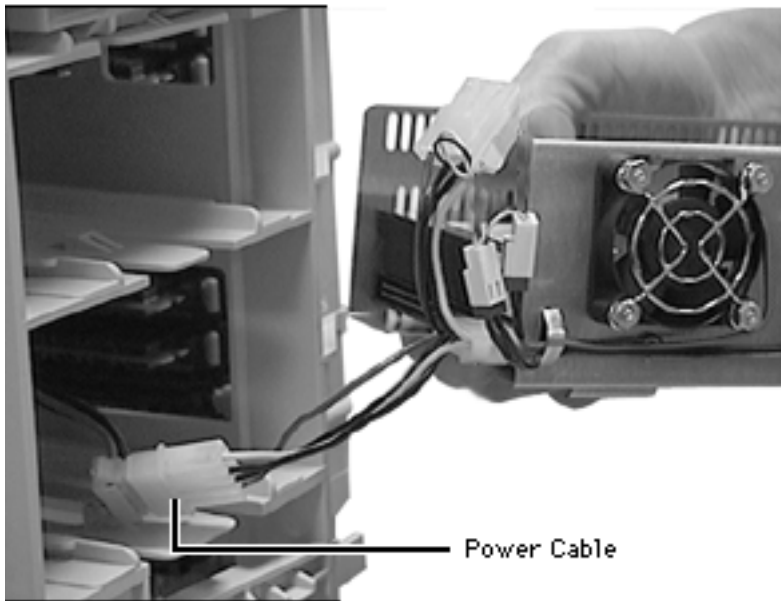

- 3 Disconnect the power cable at the connector location shown in the photograph at left.
- 4 Remove the hard drive from the bracket before returning the drive to Apple.

Note: You can install up to two hard drives in the hard drive bracket. There are four screws that attach the bracket to the sides of each hard drive.



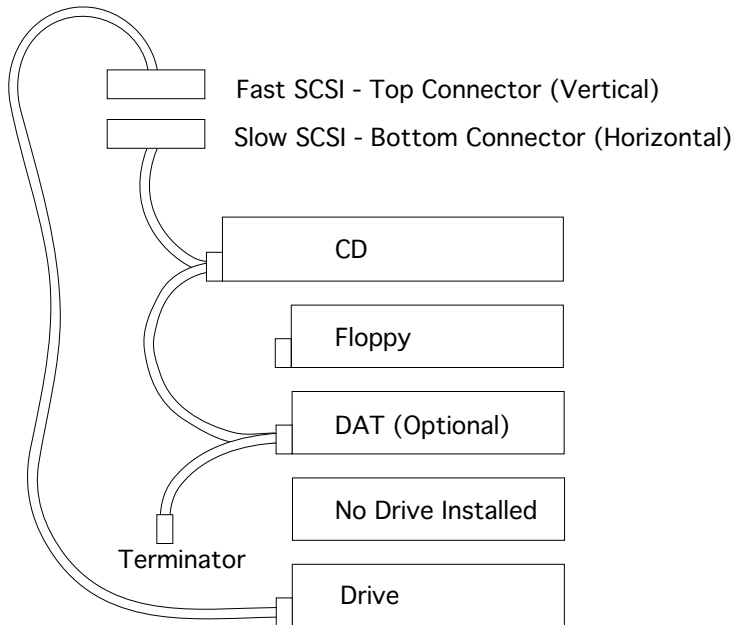

- 5 If you are installing a single drive in the WS 8550, connect the SCSI cables as shown in the illustration on the left.



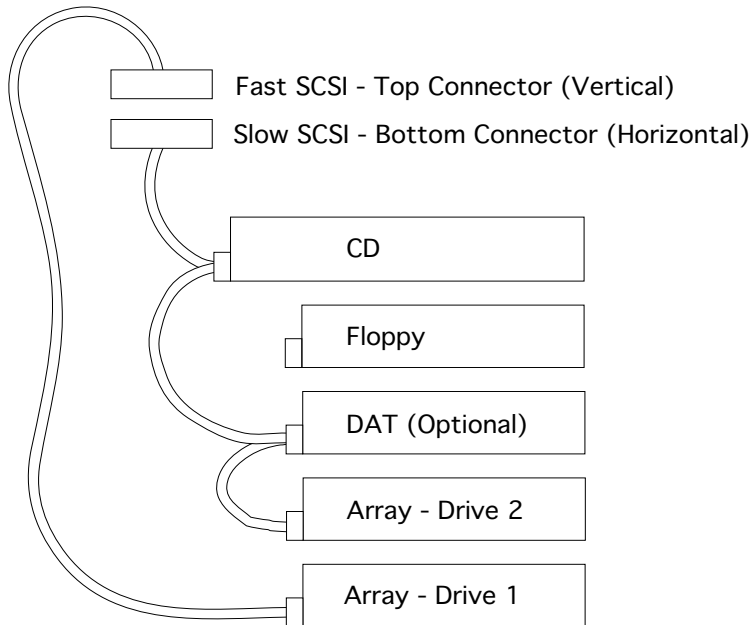

- 6 If you are installing two drives in the WS 8550, connect the SCSI cables as shown in the illustration on the left.



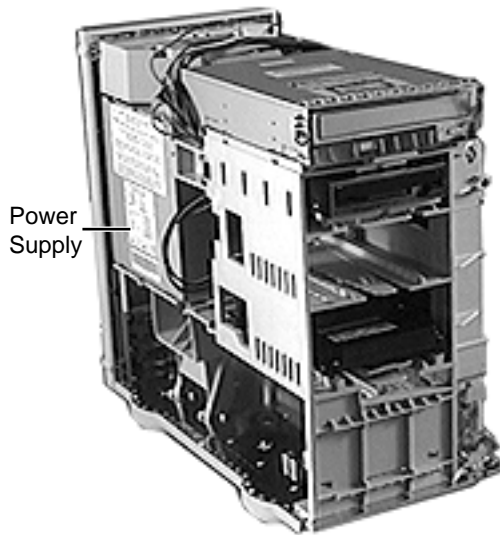

Power Supply

Before you begin, remove the top housing.

Note: As you face the computer, the power supply is located in the back of the chassis, directly beneath the speaker.



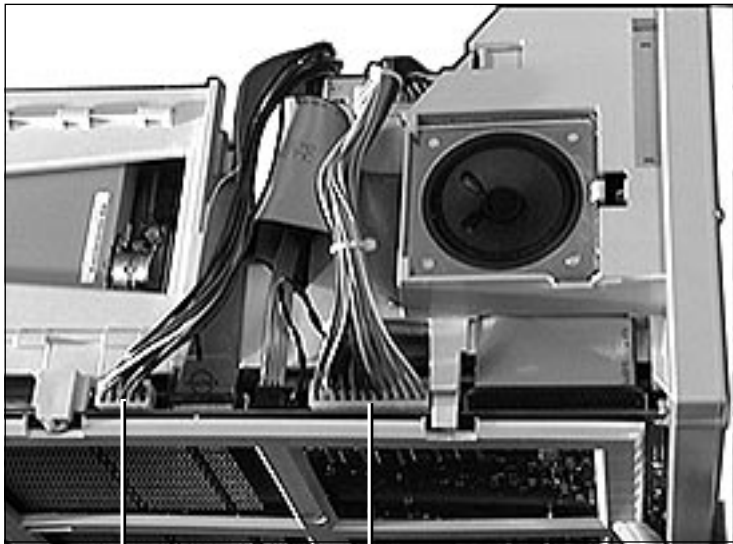

Power Supply Cable

Power Supply Cable

- 1 Disconnect the two cables that run from the power supply to the logic board.

Note: The 10-pin power supply cable supplies 3.3 V power for the processor card. The 22-pin cable supplies 5 V and +/- 12 V power for the logic board.



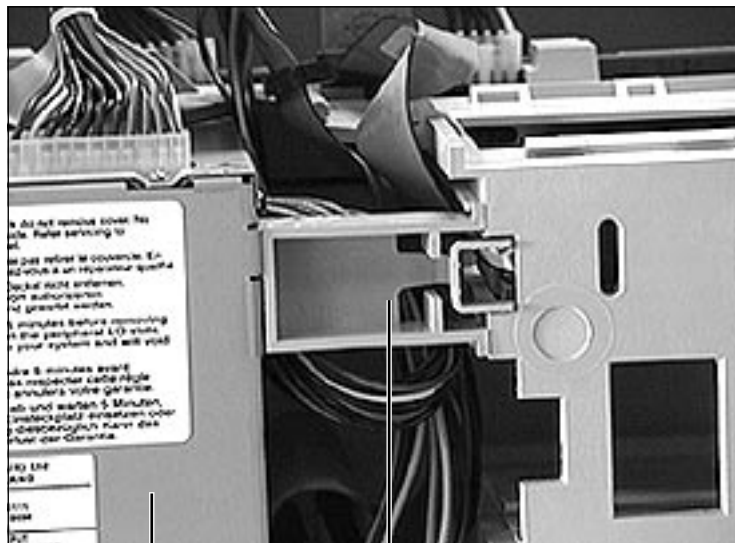

Power Supply

Chassis Support Brace

- 2 Turn the computer sideways so you are facing the power supply. (The power supply should be to your left and the drive bays to your right.)
- 3 Locate the chassis support brace, which is between the power supply and the drive bays.





Chassis Support Brace

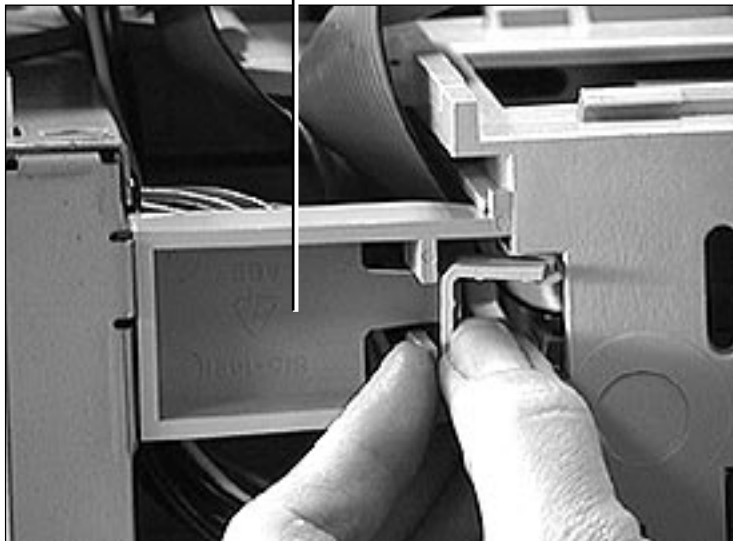

- 4 Push in the latch located on the right side of the chassis support brace and pull out the brace to remove it.



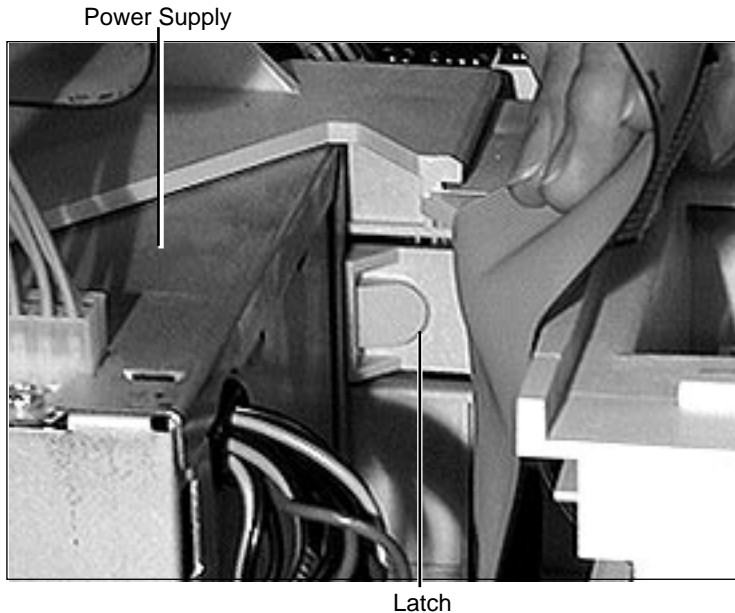

- 5 Push in the plastic latch that secures the power supply to the chassis. The latch is located to the right of the power supply.



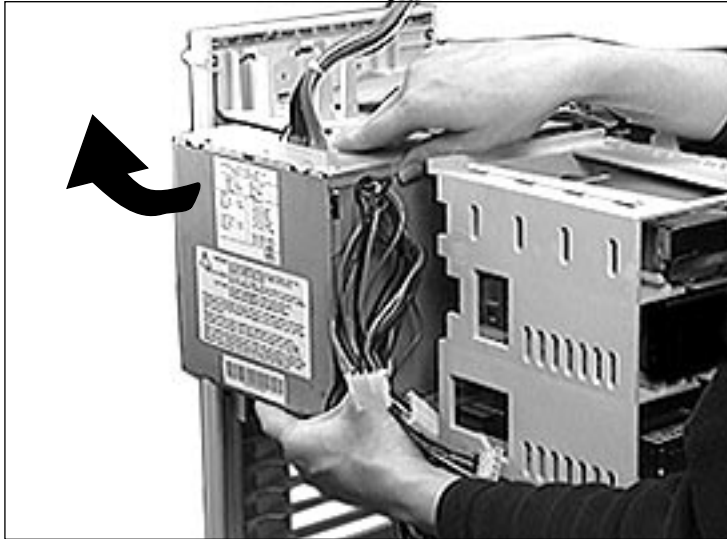

- 6 Slide the power supply forward and pull it out of the computer.
- 7 Remove the 22-pin cable from the power supply.

Replacement Note: There are two metal tabs on the back of the power supply on its bottom edge. You must feed these tabs through two openings in the chassis before you slide the power supply back into place.





Speaker

Before you begin, remove the top housing.

Note: As you face the computer, the speaker is on top of the chassis at the back end of the computer.



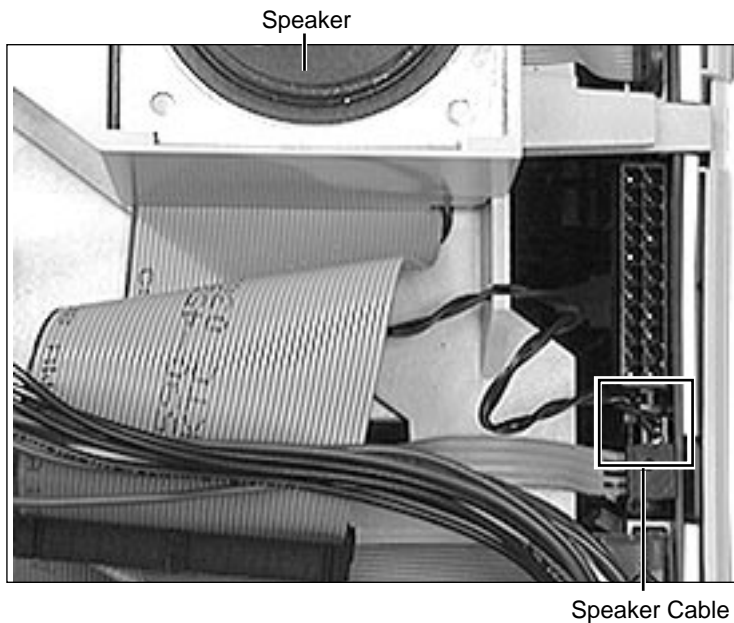

- 1 Disconnect the speaker cable from the logic board.



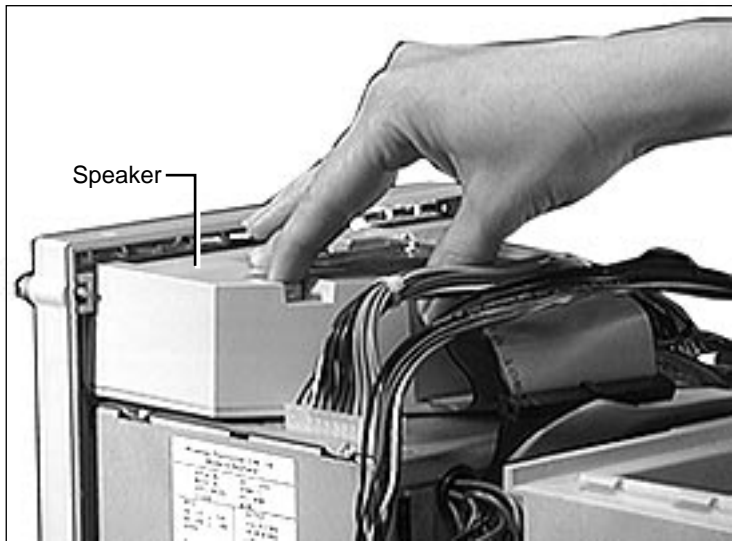

- 2 Press the latch holding the speaker housing to the chassis and lift the front of the speaker housing.



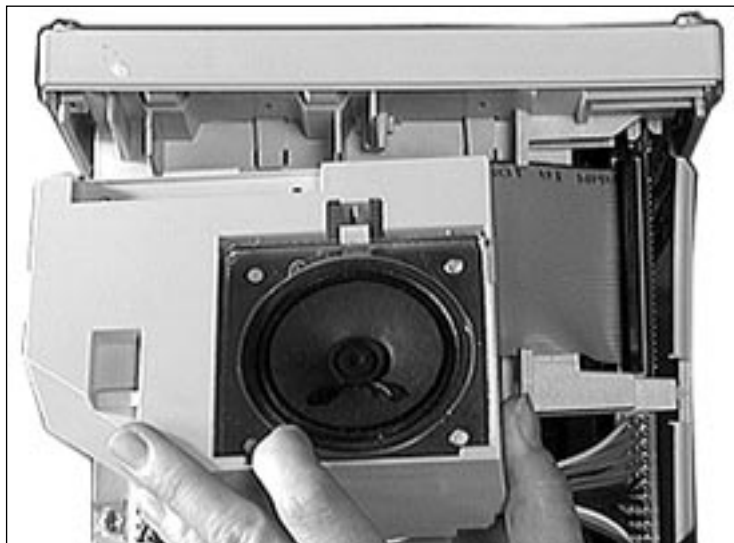

- 3 Pull the speaker housing from the clips at the rear of the chassis.





Rear Panel

Rear Panel

Before you begin, remove the following:

- Top Housing
- Speaker

Note: To locate the rear panel, turn the computer so the back faces you. The rear panel is the back part of the housing.



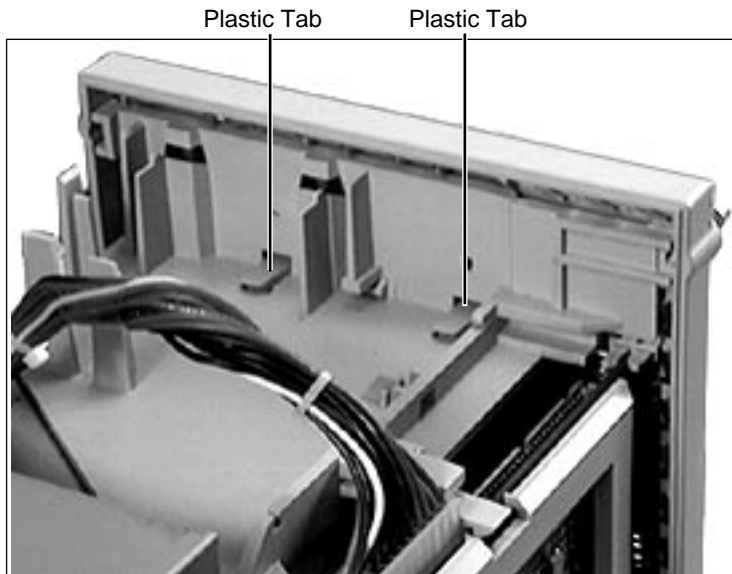

- 1 Two plastic tabs at the top of the rear panel secure the rear panel to the chassis. Lift the two tabs to release the rear panel.



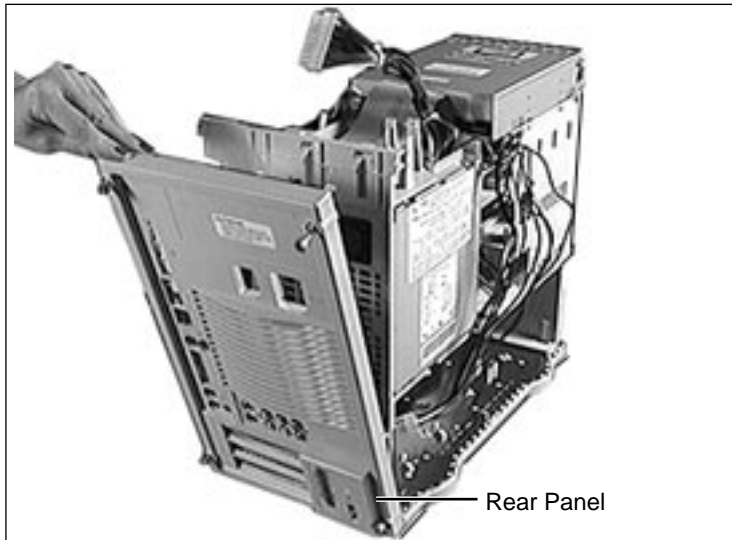

- 2 Pull down the rear panel and lift it out of the chassis.



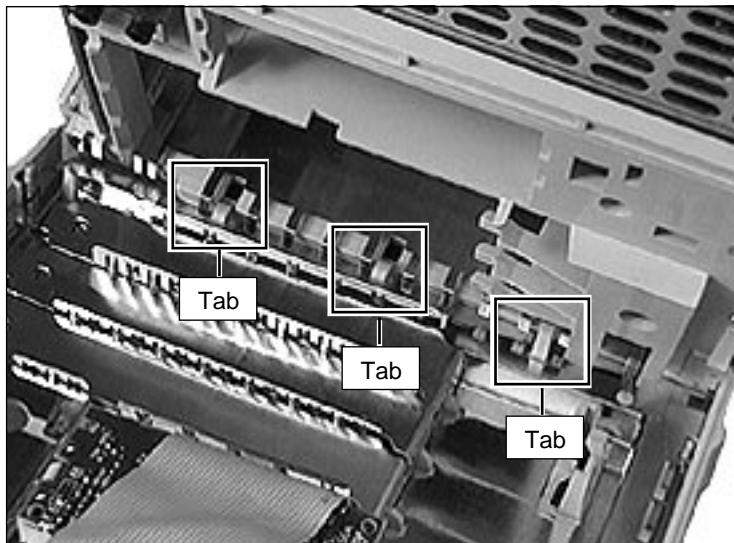

Replacement Note: First, insert the bottom tabs on the rear panel into the slots in the bottom chassis. Next, swing the rear panel up until it locks into place.





AV Module

AV Module- Power Macintosh 8500

Before you begin, remove the following:

- Top Housing
- Speaker

Note: As you face the back of the computer, the AV module is in the center of the rear panel, directly above the PCI expansion slots.



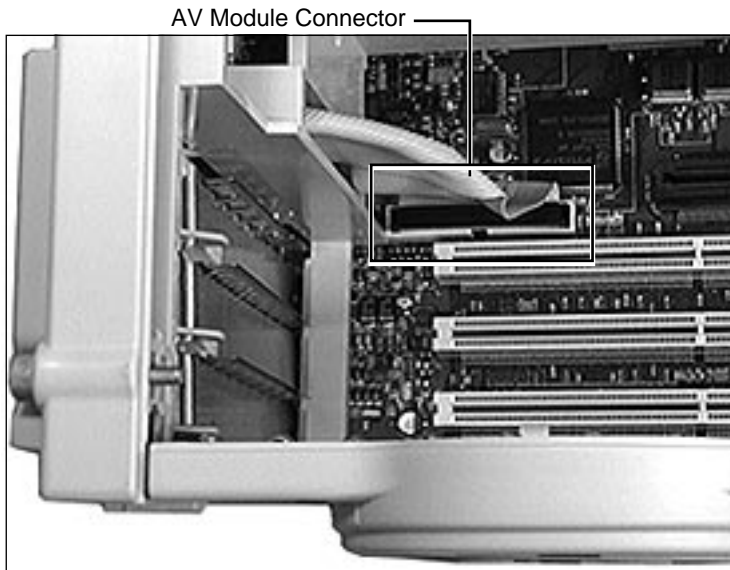

Note: Lay the computer on its side (logic board side down) to provide access to the logic board connectors. Be sure to keep the computer on a padded, static-free work surface.

- 1 Disconnect the AV module cable from the logic board.

Note: The AV module connector is directly above the PCI slots on the logic board.



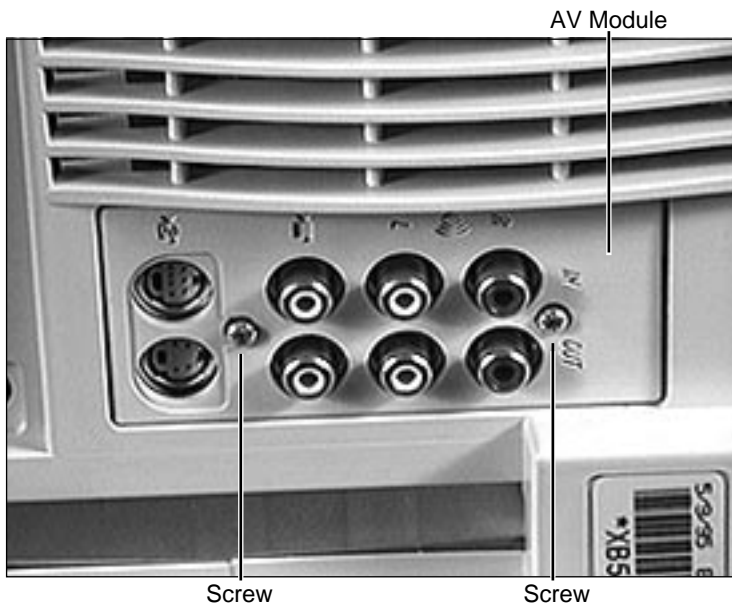

Note: Turn the computer right side up again with the rear facing you.

- 2 Remove the two Torx screws that secure the AV module to the rear panel.

Note: The AV module's plastic cover does not come off. It is part of the rear panel.



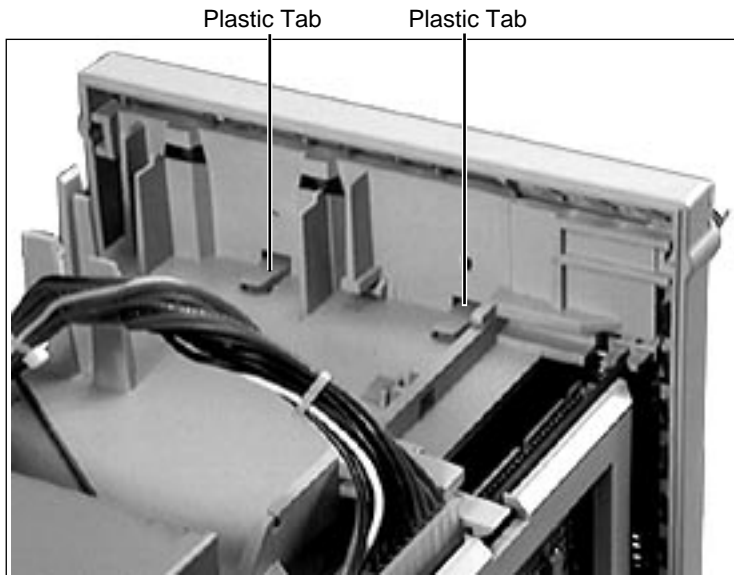

- 3 Two plastic tabs at the top of the rear panel secure the rear panel to the chassis. Lift the two tabs to release the rear panel.



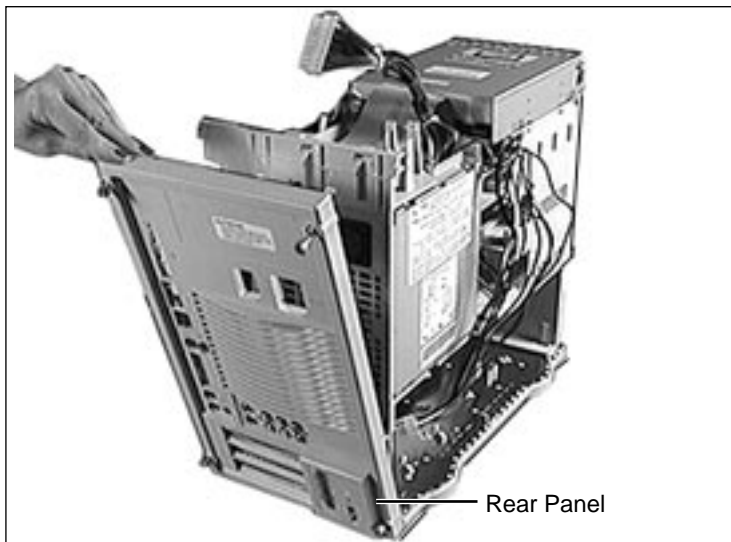

- 4 Pull down the rear panel and lift it out of the chassis.



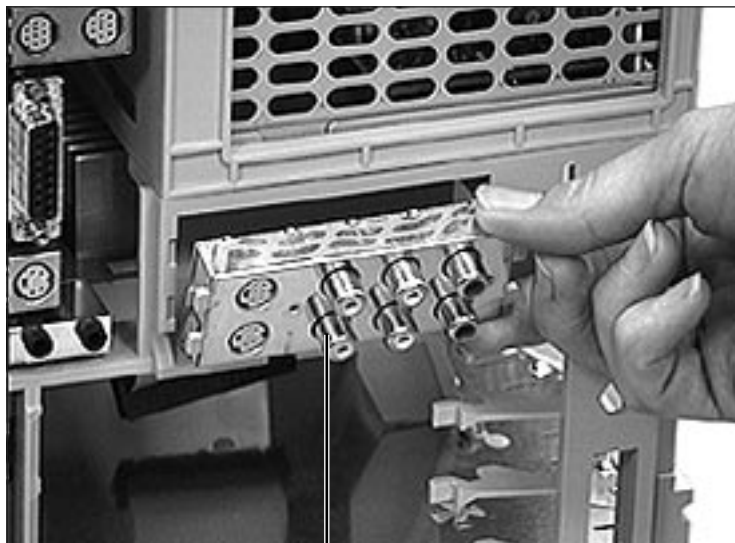

AV Module

- 5 Lift the AV module out of the computer.





PCI Retainer

Before you begin, remove the top housing.

Note: As you face the front of the computer, the PCI retainer is on the left side. It attaches to the inside of the bottom chassis.



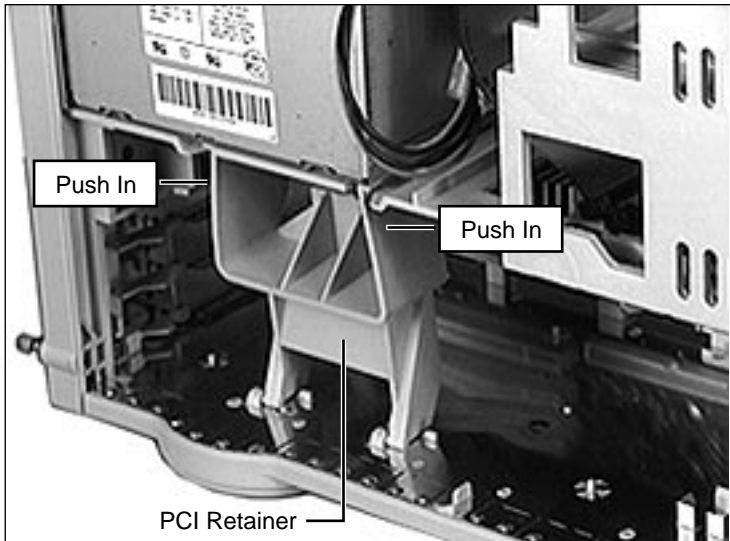

- 1 Push in on the top of the PCI retainer from both the left and right sides while pulling down on the retainer.



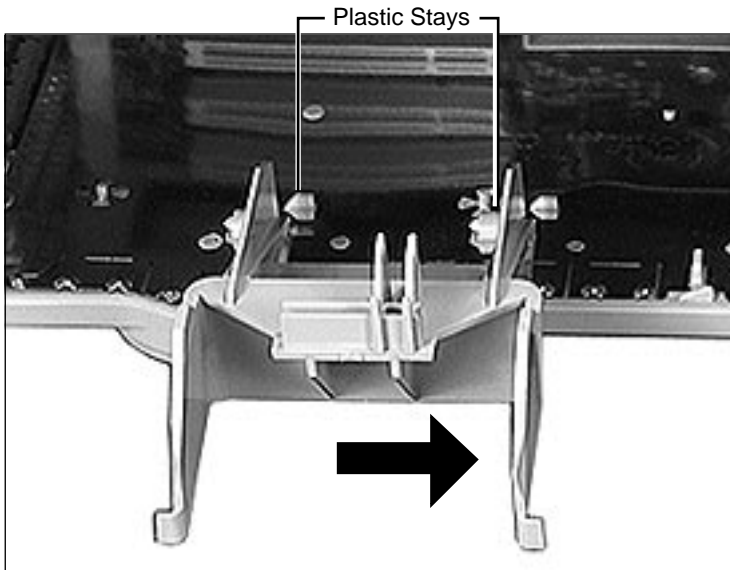

- 2 To release the bottom tabs on the retainer from the plastic stays on the bottom chassis, slide the retainer to the right.



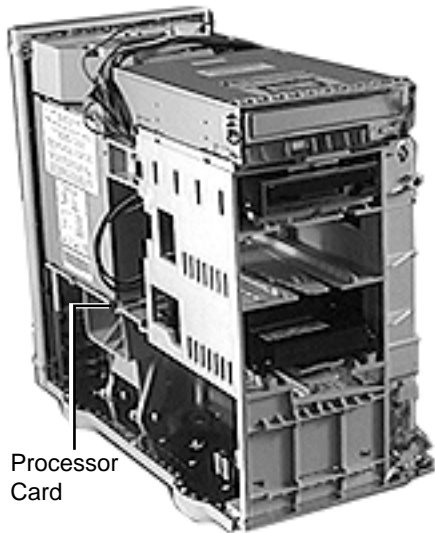

Processor
Card

Processor Card

Before you begin, remove the following:

- Top Housing
- PCI Retainer

Note: As you face the computer, the processor card is plugged into the logic board on the left side, directly beneath the power supply.

Note: For best access, lay the computer on its side with the power supply facing up.





Processor Card

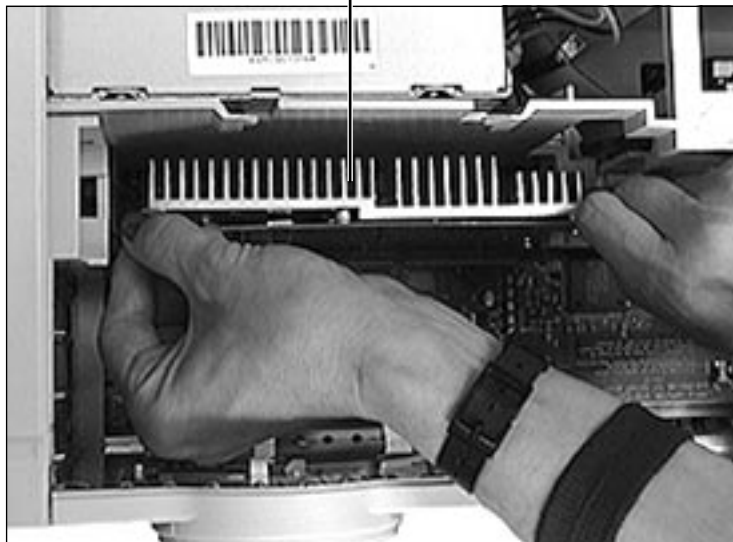

Warning: The heat sink may be hot to the touch.

- 1 Grab the corners of the processor card (and top of heat sink if cool to the touch) and pull the card straight up to remove it.

Replacement Note: Position the card in the plastic guides and press down on the card. Do not force the card or you may damage it. Look at the connectors to make sure the card is firmly seated. Press down on the card again if necessary.





PCI Cards

Before you begin, remove the following:

- Top Housing
- PCI Retainer

Note: PCI cards plug into the logic board on the left side, directly below the processor card.

Note: For better access, lay the computer on its side with the power supply facing up.



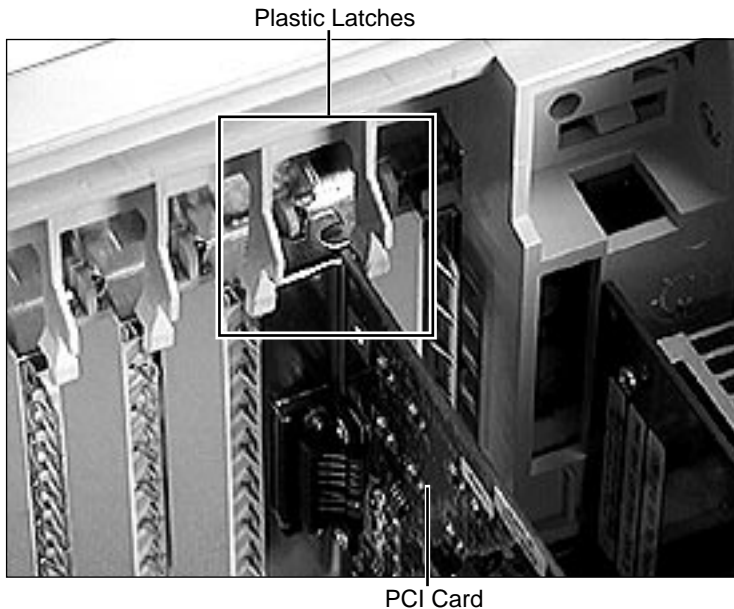

- 1 Push apart the plastic latches that secure the PCI card to the chassis and pull up the card to remove it.





Power Actuator

Before you begin, remove the top housing.

Note: As you face the computer, the power actuator is near the bottom right corner of the chassis.



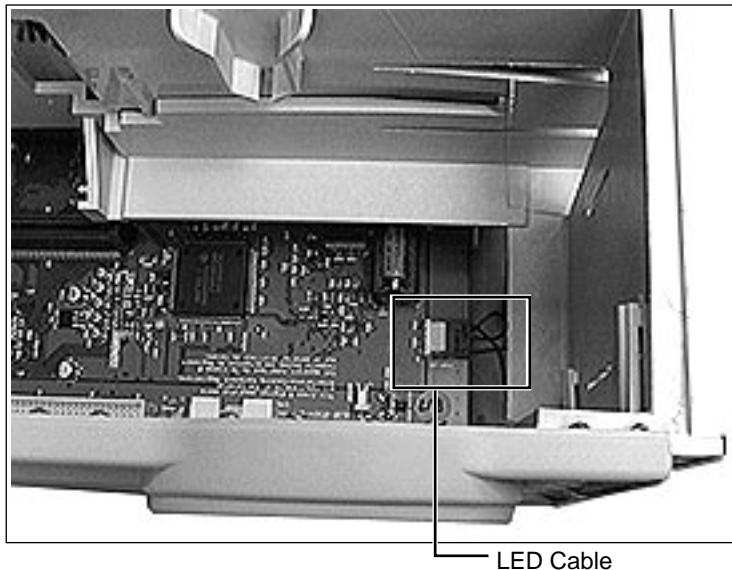

Note: Turn the computer on its side so you can access the internal connectors on the logic board.

- 1 Disconnect the LED cable, which is located near the bottom right corner of the logic board.



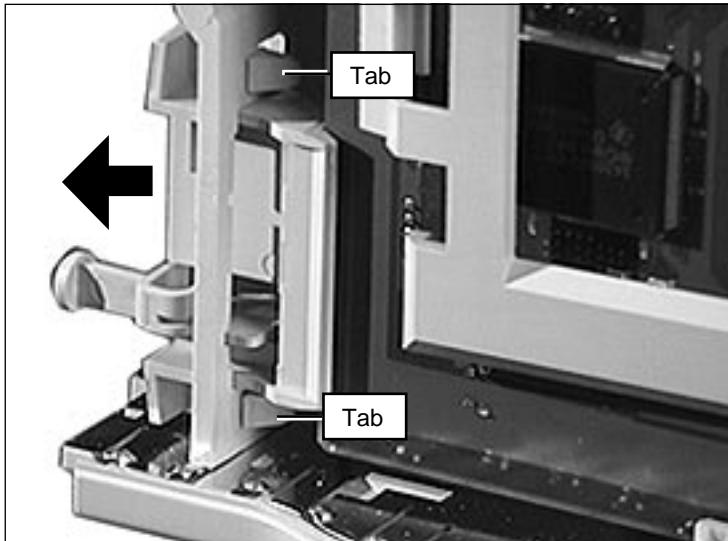

Note: Turn the computer right side up so you can access the power actuator.

- 2 Locate the power actuator at the bottom of the logic board. Press in the two plastic tabs and push out the actuator to remove it.



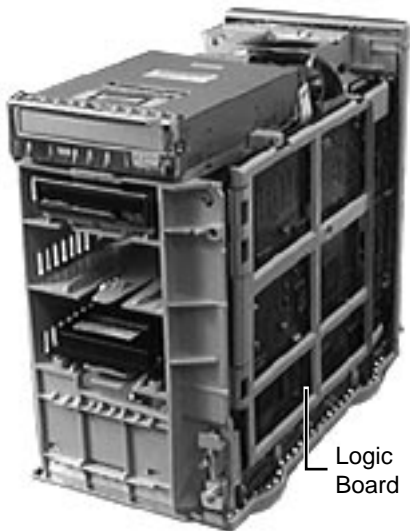

Logic Board

Before you begin, remove the following:

- Top Housing
- Power Actuator
- PCI Retainer
- Processor Card
- PCI Cards

Note: As you face the front of the computer, the logic board is on the right side and is perpendicular to the bottom chassis.



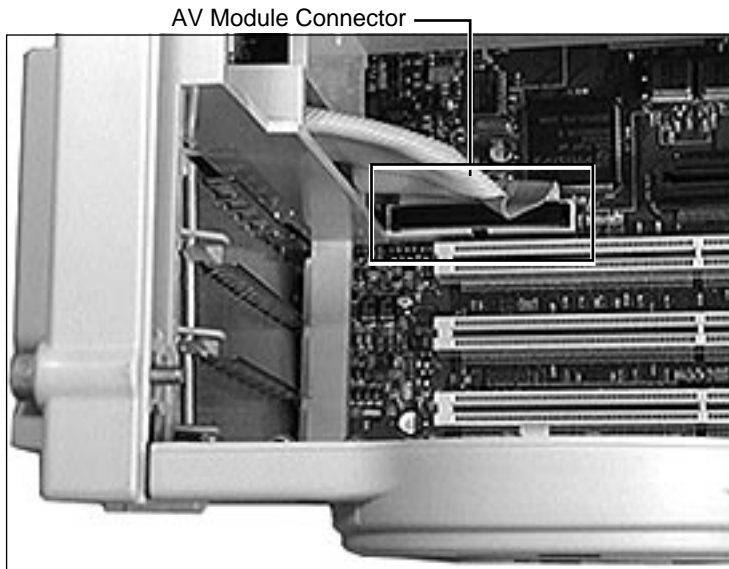

Note: The AV Module is part of the Power Macintosh 8500, but not the WS 8550.

- 1 Turn the unit on its side so you have access to the internal logic board connectors.
- 2 Disconnect the AV module cable, which is located near the bottom left corner of the logic board.



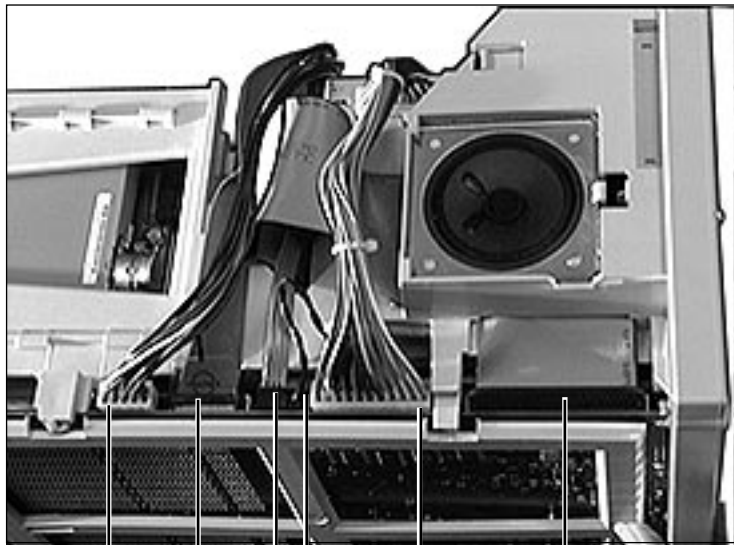

Power Supply Cable
Floppy Drive Cable
CD-Rom Audio Cable
Speaker Cable
Power Supply Cable
SCSI Cable

- 3 Turn the unit right side up so you have access to the top of the computer.
- 4 Disconnect all cables from the top of the logic board



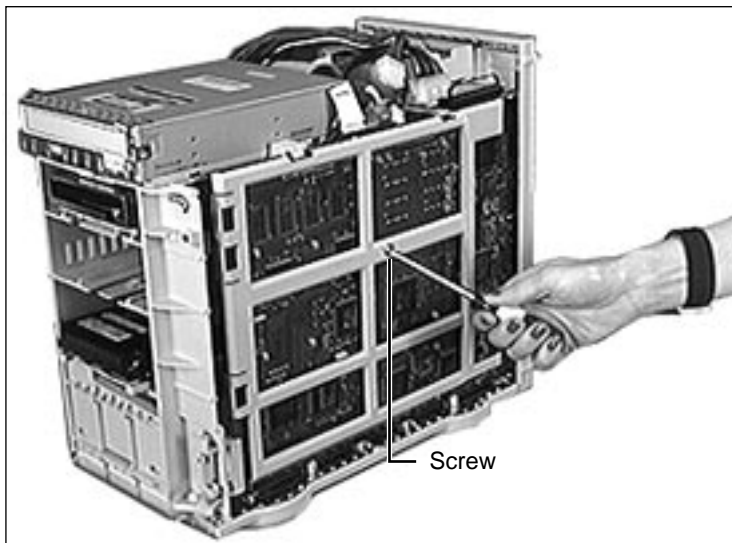

- 5 Remove the screw securing the logic board to the chassis.



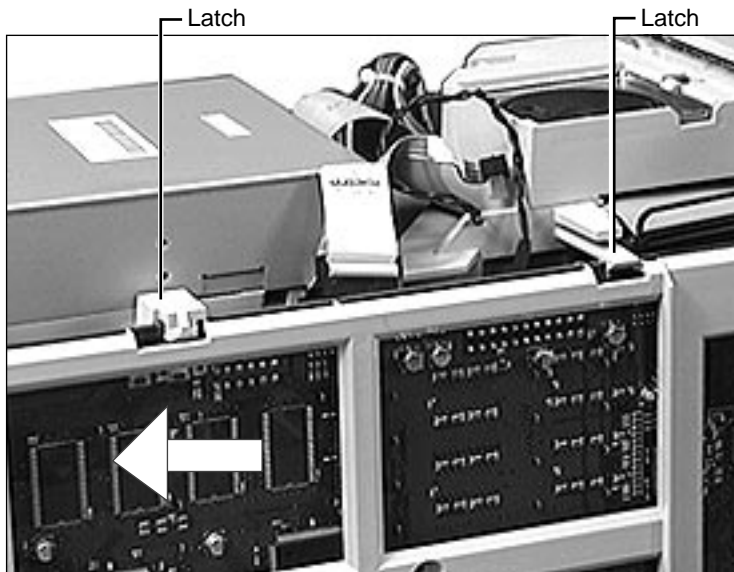

- 6 Slide the logic board to the left until the slots on the top of the logic board line up with the latches on the chassis.





- 7 Lift the latch at the top of the logic board to release the logic board.



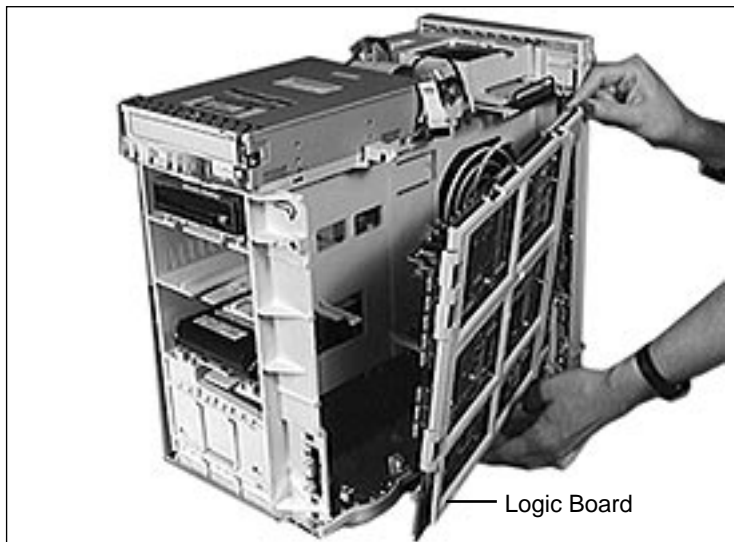

- 8 If you are removing the logic board from a Power Macintosh 8500, pivot the front of the logic board out of the chassis.

Note: Remove the DRAM, VRAM, and cache DIMMs before returning the board to Apple. Do NOT remove the ROM SIMM. Refer to the Parts Database to identify the ROM SIMM and DRAM, VRAM, and cache DIMMs.



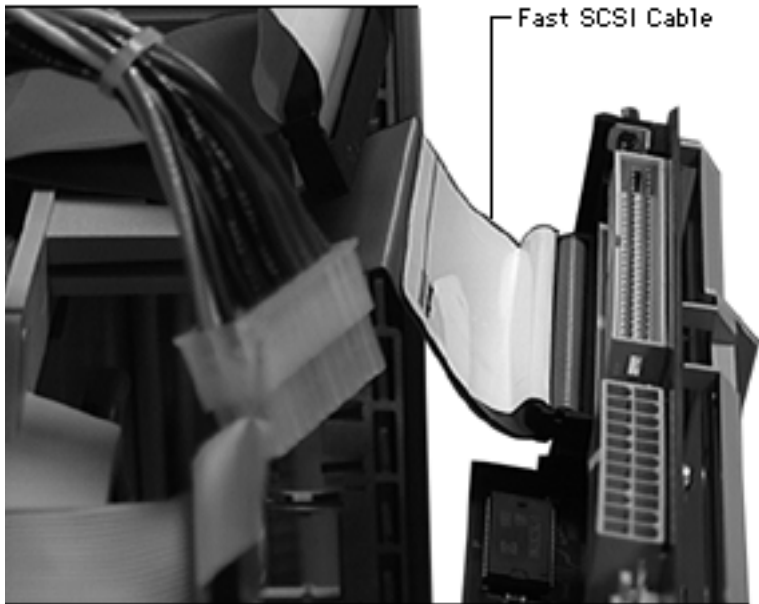

- 9 If you are removing the logic board from a WS 8550, pivot the front of the logic board out of the chassis until you can access the Fast SCSI connector. Disconnect the Fast SCSI cable from the logic board and remove the board from the chassis.





Upgrades

Power Macintosh 8500 Series/WS
8550 Series





PC Compatibility Cards

There are three Apple PC Compatibility cards that can be installed in the Power Macintosh 8500 Series computers:

- 7" 100 MHz PC Compatibility Card
- 12" 100 MHz PC Compatibility Card
- 12" 166 MHz-P PC Compatibility Card

For more information about these cards and installation instructions, refer to the PC Compatibility Card manual on this Service Source CD.





Power Macintosh 8500 Upgrade

The Power Macintosh 8500 Upgrade Kit can be used to upgrade a Quadra 800, Quadra 840, or a Power Macintosh 8100. The kit includes everything except:

- The peripherals (such as the hard drive, floppy drive, and CD-ROM drive), which must be transferred from the original unit you are upgrading
- A processor card, which must be purchased separately.

Refer to the appropriate Take Apart chapter (that is, the Take Apart chapter in the Quadra 800, Quadra 840AV, or Power Macintosh 8100 manual) for instructions on how to remove the drives from the original unit.

Refer to the Take Apart chapter in this manual to see where the peripherals should be installed in the upgraded unit and for instructions on how to install the processor card.





Once you have installed all the drives in the upgraded unit and replaced the top housing, copy the serial number from the original unit to the blank serial label on the upgraded unit.





WorkGroup Server 8550/132 Upgrade

The WorkGroup Server 8550/132 Upgrade Kit can be used to upgrade a WorkGroup Server 80, 8150/80, or 8150/110. The kit includes everything except:

- The peripherals (such as the hard drive, floppy drive, and CD-ROM drive), which must be transferred from the original unit you are upgrading
- Drive carriers
- Drive bezels
- Drive shields
- Speaker
- CD-ROM audio cable
- Floppy drive cable
- Power supply to logic board cable
- Chassis support bracket





These parts need to be removed from the original unit and installed in the upgraded unit. Refer to the Take Apart chapter for the product from which you are upgrading for instructions on how to remove these parts.

Refer to the Take Apart chapter in the Power Macintosh 8500/WS 8550 manual to see where the peripherals should be installed in the upgraded unit.

Once you have installed all the necessary parts in the upgraded unit and replaced the top housing, copy the serial number from the original unit to the blank serial label on the upgraded unit.

Note: The WorkGroup Server 8550/132 Upgrade Kit does not include a hard drive bracket.





Exploded View

Power Macintosh 8500 Series/
WS 8550 Series



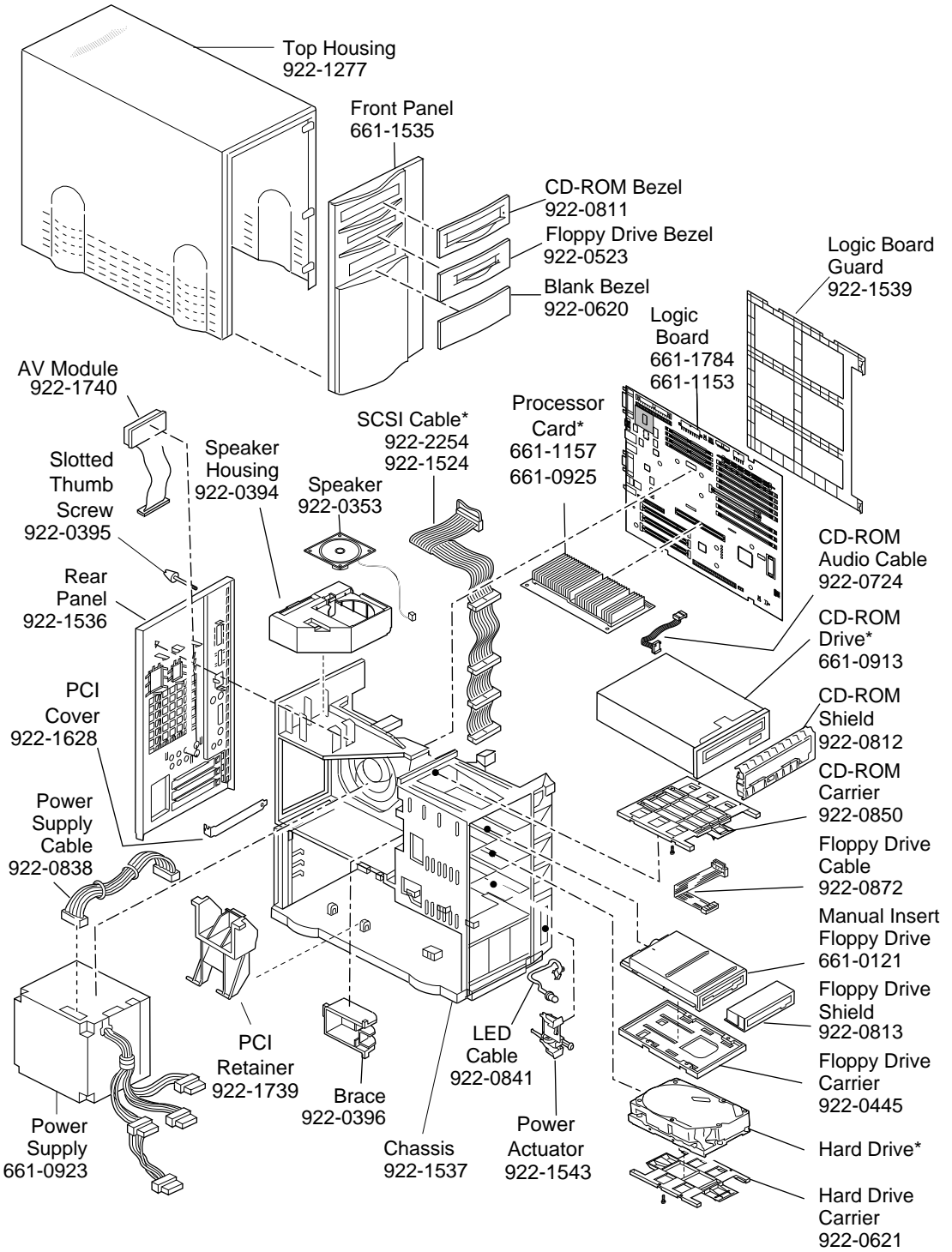

Product family configurations may vary. For parts with asterisk (*), refer to parts list.

Power Macintosh 8500



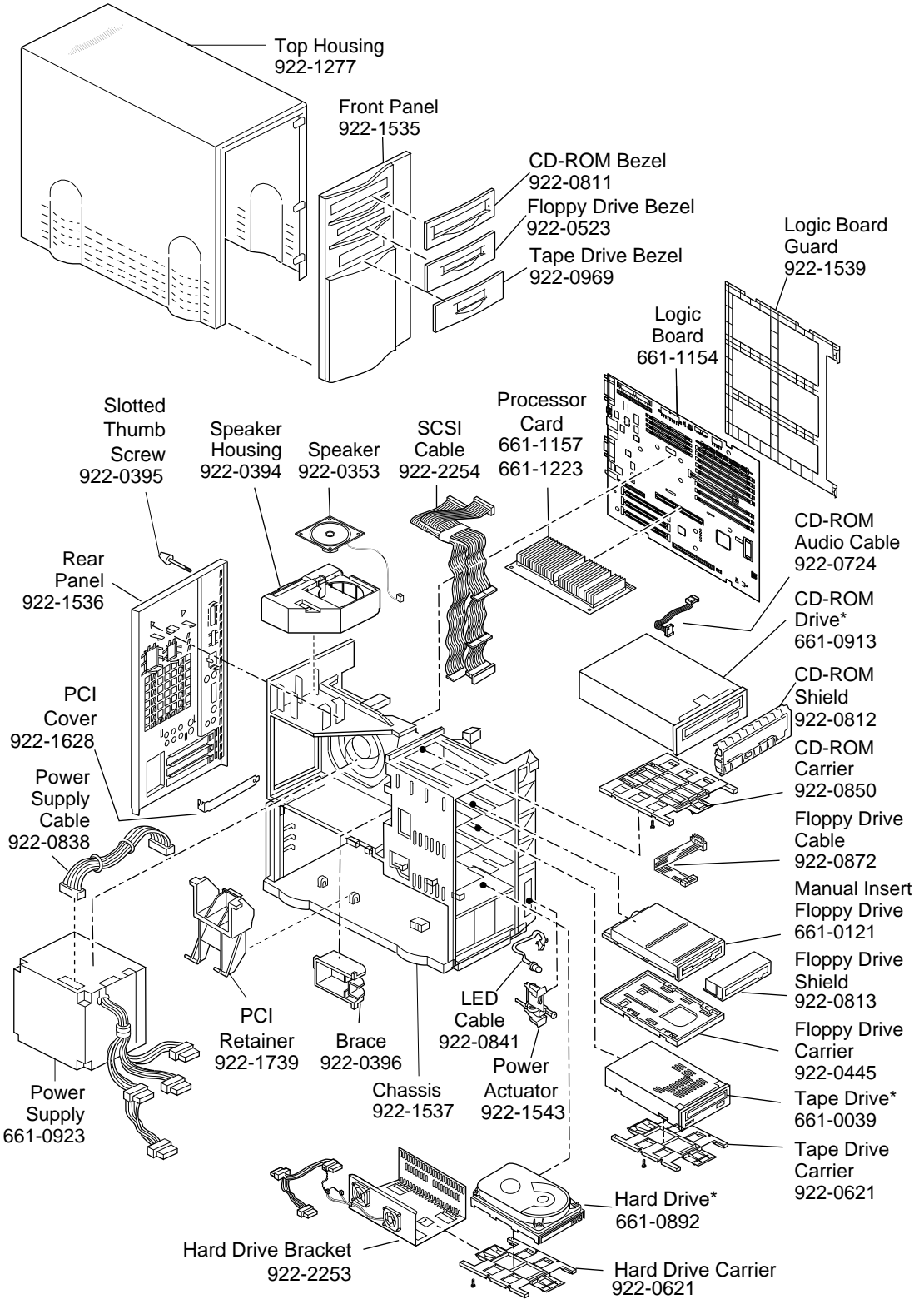

Product family configurations may vary. For parts with asterisk (*), refer to parts list.

Power Macintosh WS8550

