



# Performa/Power Macintosh 6400 and 6500 Series

Performa 6400/180, 6400/200  
Power Macintosh 6400/180, 6400/200,  
6500/225, 6500/250, 6500/275, 6500/300  
International Performa 6410, 6420





## Basics

---

Performa/Power Macintosh  
6400 and 6500 Series





## System Overview

The Performa/Power Macintosh 6400 and 6500 computers combine RISC-based PowerPC performance with full multimedia features. Several features are implemented as plug-in modules available as configuration options or later upgrade, such as PCI cards, internal storage devices, and the Apple TV/FM Radio System. The modules are designed to be user installed.



User controls include the following:

- Soft power-on control from keyboard
- Front panel sound-control push buttons
- Front panel brightness-control push buttons
- Optional infrared remote control
- Voltage switch
- Subwoofer balance control





# Configurations

## Performa 6400

The 6400 has a PowerPC 603ev processor. Expansion connections on the logic board include the following:

- DRAM DIMM expansion socket
- Communications slot for modems and Ethernet
- TV/FM tuner port
- Video-in slot
- External video port
- Two PCI expansion slots
- Two GeoPort serial ports





## **Power Macintosh 6400**

The Power Macintosh 6400 has the same feature set as the Performa 6400. It is available with a PowerPC 603ev processor running at 180 MHz or at 200 MHz.

## **Performa 6410 and 6420**

These computers are sold in Japan, Australia, and Europe. They both ship with 8X-speed CD-ROM drives. The 6410 has 16 MB of RAM and a 1.6 GB hard drive. The 6420 has up to 24 MB of RAM, a 2.4 GB hard drive, and a 256K level-2 cache card.





## **Performa 6400/200 with Zip Drive**

The 6400/200 with Zip drive is sold in the United States. It has the same feature set as the 6400/200, but differs with these features:

- 32 MB RAM
- 2.4 GB hard drive
- 8x CD-ROM drive
- 100 MB Zip drive





## Power Macintosh 6500

The Power Macintosh 6500 is similar to the Performa/Power Macintosh 6400, but differs with these features:

- Processor bus runs at 50 MHz
- DRAM expandable to 128 MB using extended data out (EDO) mode, 60 ns or faster DIMMs (no onboard RAM)
- 2 MB built-in video RAM
- Tray-loading, 12X-speed CD-ROM drive
- Zip drive option
- More monitor video modes supported
- 2D and 3D built-in hardware graphics acceleration.





### **Power Macintosh 6500/225**

The Power Macintosh 6500/225 has the 6500 feature set with a CPU running at 225 MHz and a 2 GB hard drive.

### **Power Macintosh 6500/250**

The Power Macintosh 6500/250 has the 6500 feature set with a CPU running at 250 MHz.

A configuration of the 6500/250 sold to the education market in the Americas comes with

- 4 GB hard drive
- Ethernet







A configuration of the 6500/250 sold to the consumer market in the Americas comes with

- 4 GB hard drive
- 24X-speed CD-ROM drive
- 56.6K Apple/GV Modem
- Home Software bundle
- Mac OS 8.0

A configuration sold in Europe comes with

- 4 GB hard drive
- 24X-speed CD-ROM drive
- Zip drive
- 33.6 modem
- Mac OS 8.0





A configuration sold to the consumer market in Latin America comes with

- 4 GB hard drive
- 24X-speed CD-ROM drive
- 33.6 modem
- Mac OS 8.0





## Power Macintosh 6500/275

The Power Macintosh 6500/275 has a 603e processor running at 275 MHz and comes with

- 48 MB DRAM on the logic board
- 4 GB hard drive
- 512K L2 cache card

All other hardware features are the same as previous 6500 series computers.

A configuration sold to the education market in the Americas comes with

- 32 MB DRAM
- Zip drive
- Video in
- NTSC out
- Ethernet
- Mac OS 8.0





A configuration of the 6500/275 sold to the consumer market in the Americas comes with

- 32 MB DRAM
- 6 GB hard drive
- 24X-speed CD-ROM drive
- Zip drive
- 56.6K Apple/GV modem
- Home Software bundle
- Mac OS 8.0





Another configuration of the 6500/275 sold to the consumer market in the Americas comes with

- 48 MB DRAM
- 6 GB hard drive
- 24X CD-ROM drive
- Zip drive
- 56.6K Apple/GV modem
- Microsoft Small Office software bundle
- Mac OS 8.0

A configuration sold in Asia and the Pacific comes with

- 32 MB DRAM
- 24X-speed CD-ROM drive
- Avid Cinema
- Video in
- Mac OS 8.0





## Power Macintosh 6500/300

The Power Macintosh 6500/300 has a 603e processor running at 300 MHz and comes with

- 64 MB DRAM on the logic board
- 4 GB hard drive
- 512K L2 cache card.

All other hardware features are the same as previous 6500 series computers.

A configuration sold to the consumer market in the Americas comes with

- 6 GB hard drive
- 24X-speed CD-ROM drive
- Zip drive
- 56.6K Apple/GV modem
- Home Software bundle
- Mac OS 8.0





A configuration of the 6500/300 sold to the consumer market in Latin America comes with

- 6 GB hard drive
- 24X-speed CD-ROM drive
- Zip drive
- 33.6 modem
- Mac OS 8.0

A configuration of the 6500/300 sold in Asia and the Pacific comes with

- 24X-speed CD-ROM drive
- Mac OS 8.0





A configuration sold in Europe comes with

- 6 GB hard drive
- 24X-speed CD-ROM drive
- TV/FM tuner
- Video in
- Avid Cinema
- 33.6 modem
- Mac OS 8.0







## Voltage Switch

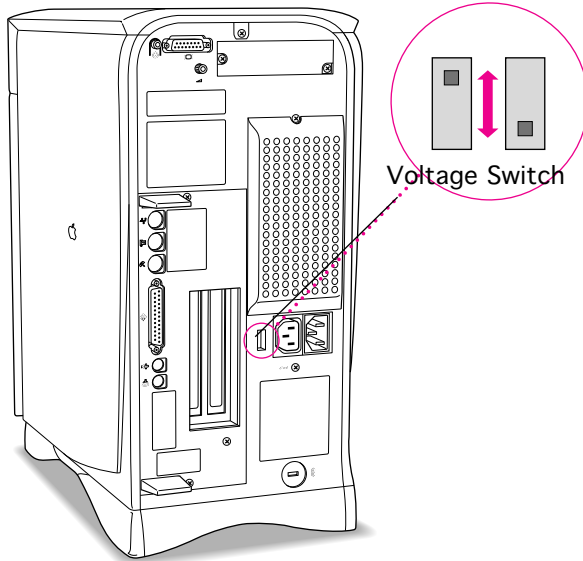

The voltage switch must be set correctly to avoid damaging the computer. Insert a screw driver in the slot to set the switch to show “115” for voltages between 100 and 130. Set the switch to show “230” for voltages between 200 and 270. Some countries use two standardized voltages. If you aren’t sure which voltage is available, check with the electricity supply company before plugging in the computer.





Here is a table listing voltages for some countries:

<b>Country</b>	<b>Voltage</b>
Japan	100
Algeria, Indonesia, Lebanon, Libya, Peru, S. Korea, Vietnam	100 or 220
Ecuador, Jamaica, Philippines, Taiwan	110
Bermuda, Canada, Puerto Rico, United States, Venezuela	120
Colombia, Mexico, Saudi Arabia	127
Brazil	127 or 220
Hong Kong	200
India, South Africa	220-250
Israel, Pakistan, Singapore	230





<b>Country</b>	<b>Voltage</b>
Australia, Kuwait, Malta, New Zealand, Northern Ireland, Papua New Guinea, Oman, Qatar, United Kingdom	240
Austria, Belgium, Denmark, Finland, France, Germany, Greece, Italy, Luxembourg, Netherlands, Norway, Portugal, Spain, Sweden, Switzerland	220-230
Bahrain, Chile, China (People's Republic), Czechoslovakia, Egypt, Greenland, Hungary, Iceland, Iran, Jordan, Liechtenstein, Nepal, Paraguay, Poland, Romania, United Arab Emirates, Russia and the Commonwealth of Independent States (CIS), Yemen, Yugoslavia	220





## Subwoofer Balance Control

With external speakers attached, the subwoofer functions as a bass speaker to augment the stereo sound. Without external speakers, the subwoofer produces full-range sound instead of just bass.

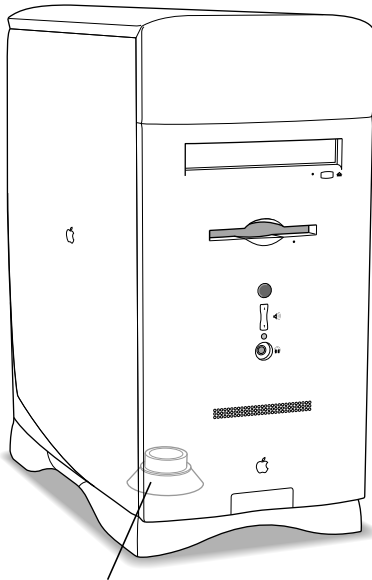

Subwoofer Internal





Subwoofer Balance Control

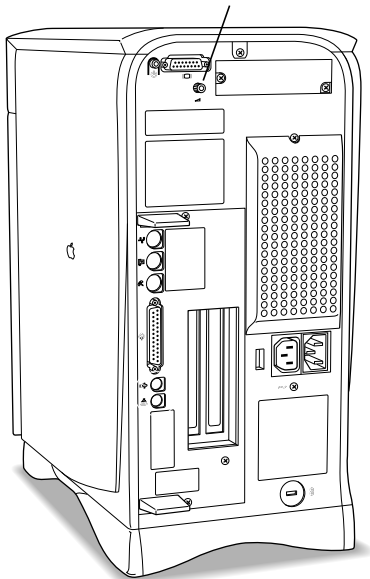

Adjust the subwoofer balance using the subwoofer balance control. The subwoofer balance control only works with external speakers attached. To increase or decrease the bass coming from the subwoofer in relation to the sound coming from the external speakers, adjust the subwoofer balance control.





## TV/FM Radio Tuner Card

The TV/FM radio tuner card turns the computer into a television and FM radio receiver, complete with remote control. An expansion ribbon connector for the optional TV/FM radio tuner card provides NTSC and PAL input from an external TV antenna or cable. Change channels by typing the channel number on the keyboard or with the remote control. Switch between the current and previous channel by pressing the Tab key. The computer displays the user-assigned channel name on the picture in the video window.

Apple Video Player software supports the TV/FM tuner card. The user can disable channels and require a password to access the disabled channels. Users can also capture or freeze a single frame of video or record a segment of video as a QuickTime movie. It isn't possible to resize the window while recording a movie.





The TV picture is in its own window on the desktop, and the default size of the window is 320x240 pixels. The picture can be resized from 160x120 pixels up to 640x480 pixels. The resolution of the picture does not increase at larger window sizes, but the image is expanded by doubling the pixel size or by two-dimensional linear interpolation.

The TV signal is carried in YUV format for improved picture clarity. The YUV format is 16-bit, with 8 bits for the Y (luminance) channel and 8 bits for the U and V (chrominance) channels to share by multiplexing. The picture is clearer because the YUV format carries more levels of luminance information.





The card is available in versions for NTSC, PAL, and SECAM television systems. The features of the TV tuner include the following:

- Remote tuner for 181 broadcast and cable channels (U.S. version)
- Coaxial connector for TV antenna or cable input (F-type connector in U.S. and Japanese version, IEC-type connector in Europe)
- TV picture in a resizable and movable window
- YUV format for improved clarity
- Closed captioning and teletext support
- Software password protection
- Automatic and manual channel programming
- Single remote control for TV and for playback of audio CDs







The features of the FM radio tuner include the following:

- FM radio frequencies received and displayed
- Stations scanned and searched up and down the frequency spectrum
- Step frequency
- DX mode to tune out harmonic spillover from other stations
- Stereo/mono station indicator
- Preset station programming





## Digital Audio Video (DAV) Technology

The optional video input card has a separate connector called the DAV connector. The DAV connector provides access from a PCI card to the video input card by means of a 60-pin cable. This allows the PCI expansion card to use the video card to transfer real-time video data to the computer. The video card accepts video from an external source and displays it in a window on the computer's monitor.

**Note:** The interface of the 60-pin DAV connector is a superset of the interface on the 34-pin DVA connector on the Power Macintosh 5200, Power Macintosh 6200, and Quadra 630 computers. An adapter cable is provided with the Performa 6400 video-in cards to connect 34-pin DVA compatible cards developed for the Power Macintosh 5200 and 6200 computers to the new 60-pin DAV connector.



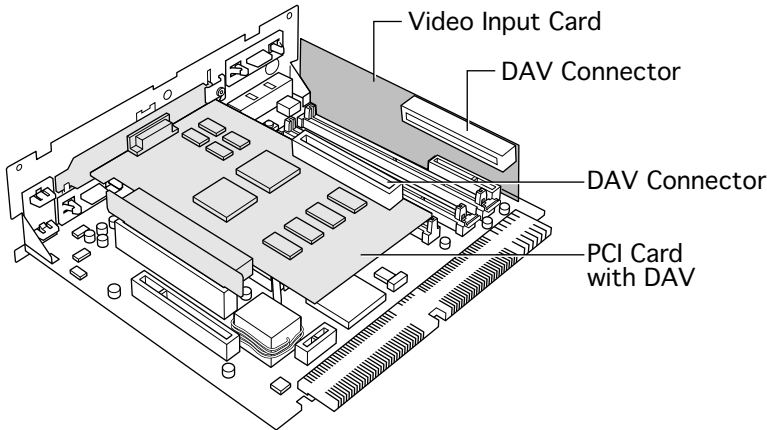

**Note:** The DAV connector on the video input card provides some of the functionality of the DAV connectors found on the Power Macintosh 7100 and 8100 models, and the Macintosh Quadra AV models, but it is not compatible with any of those connectors.





# Sound

The sound system supports 8-bit and 16-bit stereo sound output and input. It can create sounds digitally and play the sounds through the internal speakers or send the sound signals through the sound output jacks.

## Digitizing Sound

The 6400 and 6500 computers digitize and records sound as 16-bit samples. It can use two of these sampling rates—11k, 22k, or 44k samples per second. It can record sound from the following sources:

- Built-in microphone
- Microphone connected to the sound input jack
- Video input module
- Compact disc in the CD-ROM player





## Sound Output

The 6400 and 6500 computers have one built-in speaker/subwoofer and two sound output jacks, one on the front and one on the back. Both output jacks are connected to the sound amplifier. Inserting a plug into either jack disconnects the internal speakers. The jack on the front is intended for headphones, and the jack on the back is intended for external speakers. The rear jack is muted when headphones are plugged in the front jack.





## Sound Input

One sound input port for stereo sound input supports the Apple PlainTalk Microphone, and it supports non-Apple microphones. It also supports a standard stereo (miniplug-to-RCA) cable adapter for connecting stereo equipment to the computer.

**Note:** The sound input port does **not** support the Apple Omni microphone (the round microphone shipped with some earlier Macintosh models) or the attenuated RCA adapter provided with some models of Macintosh.





## Expansion Bay

The expansion bay includes audio, data, and power connectors for adding a SCSI CD-ROM or other SCSI device. The bay is configured for 5.25-inch devices, but with modification to the carrier, a 3.5-inch SCSI device could be installed. In some computers, the bay may already be occupied by a Zip drive.





## Chassis Revision Identification

There are two versions of the Metal Chassis Assembly for the Power Macintosh/Performa 6400 and 6500 series machines. Part number 922-2272 Chassis, Metal, Rev. A should be used for all Power Macintosh/Performa 6400 series machines with the exception of the PM/Perf 6400/200 with Zip Drive. Part number 922-2707 Chassis, Metal, Rev. B should be used for all Power Macintosh 6500 series machine as well as the PM/Perf 6400/200 with Zip Drive.







## Intelligent Device Electronics (IDE) Hard Drive

The internal hard drive uses IDE technology, commonly used in DOS-compatible systems, and the standard ATA-2 or IDE interface. The hard drive has a standard 40-pin ATA connector, and a separate 4-pin power connector.

The IDE hard drive functions the same as a typical SCSI hard drive. You must replace IDE drives like for like. The IDE drive does not affect SCSI ID selections or SCSI termination schemes. Six external SCSI devices may be daisy-chained through the external SCSI port.





## Peripheral Component Interconnect (PCI) Technology

The 6400 and 6500 computers offer a peripheral component interconnect (PCI) expansion bus. Because the PCI bus is an industry standard, most existing PCI 2.0-compliant cards (with the addition of a Macintosh OS-specific software driver) will work in these computers.

PCI offers significantly higher performance than the NuBus architecture used in previous Macintosh models. Running at 33 MHz, the PCI bus is up to three times faster than NuBus, offering overall enhanced system performance, particularly in the areas of video and networking.





**Note:** PCI expansion slots are compatible with all PCI 2.0 specification-compliant cards with the addition of Macintosh-OS-specific software driver. Nubus cards **cannot** be used in this expansion slot. PDS cards for the Macintosh LC family, the Macintosh Quadra 630 computer, or cards that operate in the I/O expansion slot in Power Macintosh 5200 and 6200 computers are **not** compatible with the PCI expansion slots.





## Communications

The logic board has a communications slot for adding a communications module without occupying the PCI expansion slots. The slot uses a PCI bus, and supports the following cards:

- 10Base-T (twisted pair) Ethernet card
- 10Base-2 (thin coax) Ethernet card
- AAUI (Apple standard) Ethernet card
- 28.8 bps fax/data modem card

**Note:** This PCI bus-compatible slot is **not** compatible with communications cards for the Macintosh LC family and Macintosh Quadra 630 or with cards that operate in the Power Macintosh 5200 and 6200 communication slots. The exception is that cards that do not use the bus, such as serial modem cards, have been designed to work in either type of communications slot.





## Modems

Some Performa 6400/180 and 6400/200 computers shipped with internal GeoPort modems and some with internal Global Village modems. If the modem isn't replaced like-for-like, the communications software is incompatible with the modem.

To identify the modem originally shipped in the computer look at the last three characters of the serial number to compare with characters found in this table.

<b>Modem</b>	<b>6400/180</b>	<b>6400/200</b>
Global Village Platinum	7U7	836
GeoPort	95R	95S





## GeoPort Technology

Geoport is a hardware and software communications architecture that has been optimized for computer-telephony integration. It has three main attributes:

- It lets any GeoPort-compatible computer connect to any telephone (analog or digital, public or private) anywhere in the world.
- Once connected, it supports an arbitrary number of independent data streams up to a total bandwidth of 2 MB/second.
- Unlike traditional asynchronous data communications (such as AppleTalk), GeoPort also supports isochronous data streams (such as real-time voice and video) and provides the real-time Application Program Interfaces (APIs) necessary to hide the implementation details from both the recipient and the sender.





## Dual In-Line Memory Modules (DIMMs)

The 6400 and 6500 come with 16 MB of DRAM. Two 168-pin sockets allow for memory expansion.

The 6400 and 6500 use DRAM Dual In-Line Memory Modules (DIMMs) instead of DRAM Single In-Line Memory Modules (SIMMs). Whereas SIMMs have 72 pins, DIMMs have 168 pins. The extra pins provide a 64-bit data path, compared to a 32-bit data path for SIMMs.





**Important:** The SIMMs used in previous Macintosh models are **not** compatible with the 6400 or 6500. For the Performa 6400, use 168-pin, fast-paged, 70 ns or faster, 2K refresh rate DIMMs. For the Power Macintosh 6400, use 168-pin extended data out (EDO) mode, 60 ns or faster, and 1K or 2K refresh count. For the Power Macintosh 6500, use 168-pin, 5-volt buffered extended data out (EDO) mode, 60 ns or faster, 2K refresh rate DIMMs. Do **not** use DIMMs with a 4K refresh count.

Also, the JEDEC MO-161 specification shows three possible heights for the 8-byte DIMM. For these computers, use only the shortest of the three (1.100 inches). Taller DIMMs put excessive pressure on the DIMM sockets due to mechanical pressure inside the case.







## Performa/Power Macintosh 6400

DRAM DIMMs can be installed individually. However, if you wish to take advantage of the computer's interleaving capability, which provides maximum performance, you must install the DIMMs in matching pairs.

Memory interleaving allows the computer to read or write to its memory while other memory reads or writes are occurring, thus providing for faster performance.

**Note:** DIMMs purchased from different manufacturers can be paired as long as they are the same size and speed.





## Power Macintosh 6500

The 8-byte DIMMs can be installed one or more at a time. The logic board supports only linear memory organization, and no performance gains result when two DIMMs of the same size are installed. Any supported size DIMM can be installed in either DIMM slot, and the combined memory of all installed DIMMs is configured as a contiguous array of memory.

The DIMM slots accommodate 168-pin, 5-volt, fast-paged and EDO DRAM DIMMs. The largest DIMM supported is a two-bank DIMM holding 64 MB.

**Note:** The logic board does **not** support 3.3-volt EDO DIMMs. These DIMMs don't mechanically fit into the DIMM slots.





## Cache Expansion

The optional 256K (512K for the 6500/275 and 6500/300) level-2 cache is on a 160-pin DIMM card that plugs into a 160-pin edge connector on the logic board and includes an integrated cache controller.

**Note:** Apple does **not** support third-party cache cards for these computer models. The 160-pin cache expansion slot is **not** compatible with cache cards for previously released Power Macintosh computer models.





## 6500 Supported Monitor Resolutions

The system software on Power Macintosh 6500 computers allows selecting monitor resolutions above 1152 x 870. But these higher resolutions cause poor video output, such as misaligned or skewed video, low brightness, and so on.

Monitors connected to Power Macintosh 6500 computers should not be set to resolutions above 1152 x 870. Check the Monitors and Sound Control Panel to make sure the resolution is set to 1152 x 870 or below.





Here is a chart of Power Macintosh 6500 supported monitor resolutions.

Display Resolution	Pixel Depth	Vertical Scan Rate	Video Input	QuickDraw 2D Acceleration	QuickDraw 3D Acceleration
512 x 384	8	70 Hz	Yes	Yes	No
512 x 384	16,32	70 Hz	Yes	Yes	Yes
640 x 480	8	60,67,72, 75,85 Hz	Yes	Yes	No
640 x 480	16	60,67,72, 75,85 Hz	Yes	Yes	Yes
640 x 480	32	60,67,72, 75,85 Hz	Yes	Yes	Depends on application window size
640 x 870	16	75 Hz	Yes	Yes	No





Display Resolution	Pixel Depth	Vertical Scan Rate	Video Input	QuickDraw 2D Acceleration	QuickDraw 3D Acceleration
800 x 600	8,32	56,60,72, 75,85 Hz	Yes	Yes	No
800 x 600	16	56,60,72, 75,85 Hz	Yes	Yes	Depends on application window size
832 x 624	8,32	75 Hz	Yes	Yes	No
832 x 624	16	75 Hz	Yes	Yes	Depends on application window size
1024 x 768	8,16	60,70,75 Hz	Yes	Yes	No
1152 x 870	16	75 Hz	Yes	Yes	No





# Front View

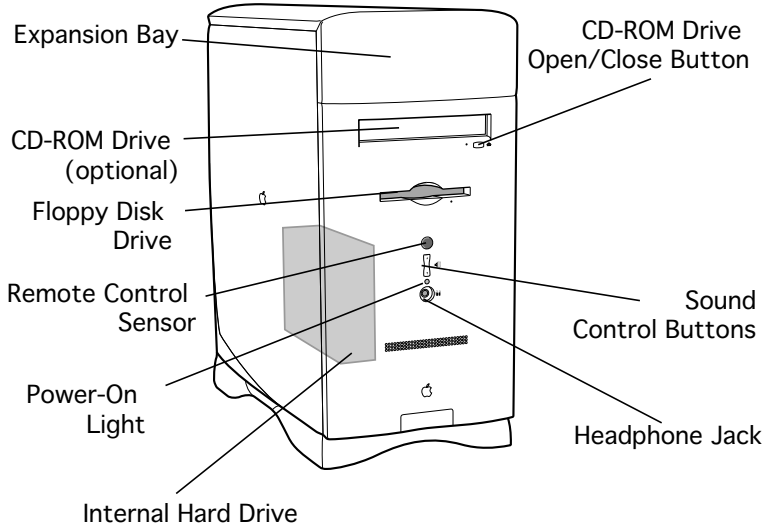



# Rear View

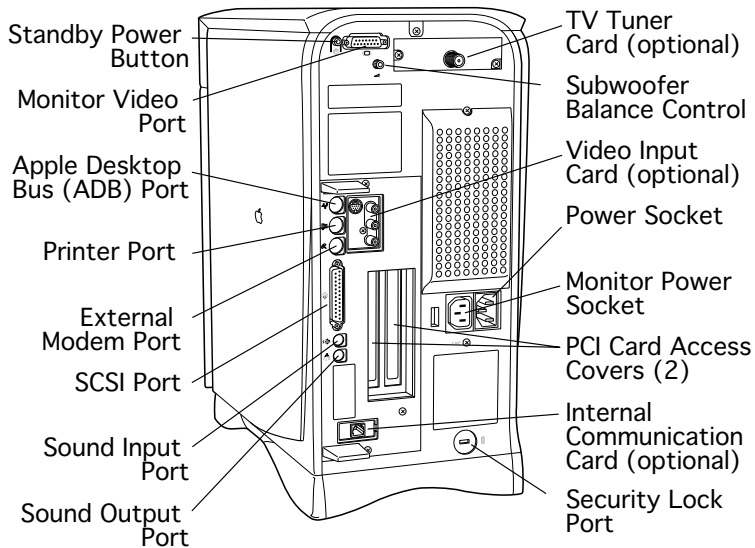





# Logic Board

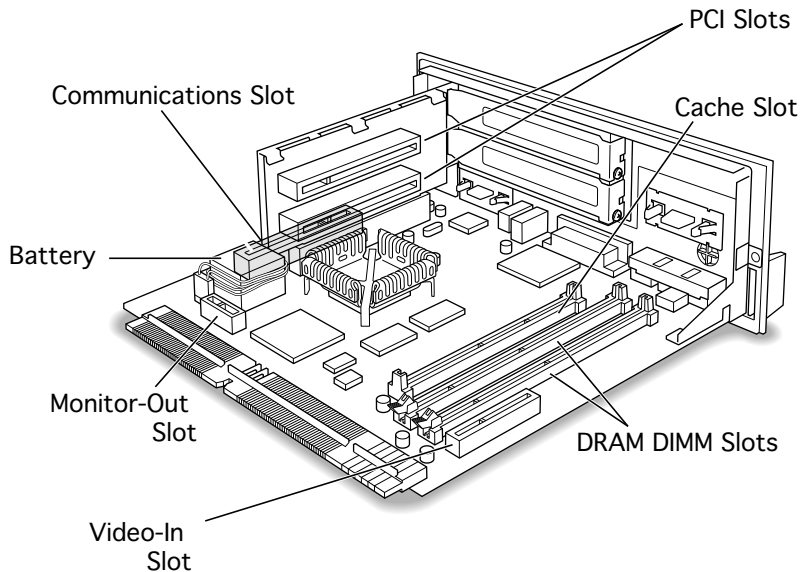



## Repair Strategy

Service the Power Macintosh/ Performa 6400 and 6500 series computers through module exchange and parts replacement. Customers can request on-site service from an Apple Authorized Service Provider Plus (AASP+) Apple Assurance (US only), or Apple Canada Technical Answerline (Canada only). They can also choose carry-in service from an AASP.

### **Ordering**

Apple Service Providers planning to support the computer systems covered in this manual may purchase Service modules and parts to develop servicing capability. To order parts, use the AppleOrder (US only) or ARIS (Canada only) system and refer to the Power Macintosh G3 “Service Price Pages.”





Large businesses, universities, and K-12 accounts must provide a purchase order on all transactions, including orders placed through the AppleOrder (US only) or ARIS (Canada only) system.

### **USA Ordering**

US Service providers not enrolled in AppleOrder may fax their orders to Service Provider Support (512-908-8125) or mail them to

Apple Computer, Inc.  
Service Provider Support  
MS 212-SPS  
Austin, TX 78714-9125

For US inquiries, please call Service Provider Support at 800-919-2775 and select option #1.





## Canadian Ordering

Canadian Service providers not enrolled in ARIS may fax their orders to Service Provider Support in Canada (1-800-903-5284). For Canadian inquiries, please call Service Provider Support at 905-513-5782 and select option #3.





# Warranty/AppleCare/ARIS

## **US Only**

The Power Macintosh/ Performa 6400 and 6500 series computers are covered under the Apple One-Year Limited Warranty. The AppleCare Service Plan is also available for these products. Service Providers are reimbursed for warranty and AppleCare repairs made to these computers. For pricing information, refer to “Service Price Pages.”

## **Canada Only**

The Power Macintosh/ Performa 6400 and 6500 series computers are covered under AppleCare. The Extended AppleCare Service Plan is also available for these products. Service Providers are reimbursed for warranty and AppleCare repairs made to these computers. For pricing information, refer to “Service Price Pages.”





## Specifications

---

Performa/Power Macintosh  
6400 and 6500 Series





# Introduction

Specifications information for this product can be found in this chapter and also in the Spec Database, which you can access in one of three ways:

- Launch it directly by double-clicking the Apple Spec Database runtime alias at the top level of the Main Service Source CD.
- Select "Apple Spec Database" from the Service Source drop-down main menu.
- Click the Acrobat toolbar icon for the database, which is near the right end of the toolbar with the letters "SP."





## Processor

### CPU

<b>6400/180, 6410</b>	PowerPC 603ev processor 180 MHz
<b>6400/200, 6420</b>	PowerPC 603ev processor 200 MHz
<b>6500</b>	PowerPC 603ev processor 225 MHz, 250 MHz, 275 MHz, or 300 MHz







## Processor Bus

<b>6400</b>	64-bit wide, 40 MHz, supporting split address and data tenures
<b>6500</b>	64-bit wide, 50 MHz, supporting split address and data tenures





# Memory

## DRAM

**Performa 6400, 6410,  
6420**

16 MB DRAM (6420 ships with up to 24 MB DRAM)  
Expandable to 136 MB using JEDEC-standard DIMM devices in two sockets (168-pin fast-paged mode, 70 ns or faster, 2K refresh rate DIMMs)

**Power Macintosh  
6400**

16 MB DRAM  
Expandable to 136 MB using JEDEC-standard DIMM devices in two sockets (168-pin, extended data out [EDO] mode, 60 ns or faster, 1K or 2K refresh rate DIMMs)





## DRAM

### **6400/200 with Zip Drive**

32 MB DRAM

Expandable to 136 MB using JEDEC-standard DIMM devices in two sockets (168-pin, extended data out [EDO] mode, 60 ns or faster, 1K or 2K refresh rate DIMMs).

### **6500/225, 6500/250**

32 MB DRAM

Expandable to 128 MB using JEDEC-standard DIMM devices in two sockets (168-pin, 5-volt buffered extended data out [EDO] mode, 60 ns or faster, 2K refresh rate DIMMs)

### **6500/275**

32 MB or 48 MB DRAM

Expandable to 128 MB using JEDEC-standard DIMM devices in two sockets (168-pin, 5-volt buffered extended data out [EDO] mode, 60 ns or faster, 2K refresh rate DIMMs)



**DRAM****6500/300**

64 MB DRAM

Expandable to 128 MB using JEDEC-standard DIMM devices in two sockets (168-pin, 5-volt buffered extended data out [EDO] mode, 60 ns or faster, 2K refresh rate DIMMs)

**ROM**

4 MB of read-only memory (ROM)

**PRAM**

8K nonvolatile parameter memory

**VRAM****6400**

1 MB built-in video RAM

**6500**

2 MB built-in video RAM, 88 MHz synchronous graphic RAM





## Cache Memory

<b>6400, 6410, 6500</b>	Optional 256K Level 2 high performance module
<b>6400/200 with Zip Drive, 6420</b>	Standard 256K Level 2 high performance module
<b>6500/225, 6500/250</b>	Standard 256K Level 2 high performance module
<b>6500/275, 6500/300</b>	Standard 512K, Level 2 high performance module





## Disk Storage

### Floppy Drive

1.4 MB Apple SuperDrive

### Expansion

Expansion bay for one 5.25-inch SCSI CD-ROM or other SCSI device

### CD-ROM Drive

**6400**

AppleCD 600i

**6400/200 with Zip Drive, 6410, 6420**

AppleCD 1200i 8X CD-ROM drive

**6500**

Tray-loading, AppleCD 1800i (12X-speed) or 24X-speed





## Hard Drive

<b>6400</b>	1.2 GB IDE 3.5-inch hard drive
<b>6410</b>	1.6 GB IDE 3.5-inch hard drive
<b>6400/200 with Zip Drive, 6420</b>	2.4 GB IDE 3.5-inch hard drive
<b>6500/225</b>	2 GB IDE 3.5-inch hard drive
<b>6500/250</b>	3 GB or 4 GB IDE 3.5-inch hard drive
<b>6500/275, 6500/300</b>	4 GB or 6 GB IDE 3.5-inch hard drive

<b>Zip Drive (6400/200 with Zip Drive and 6500)</b>	100 MB Zip drive
---	------------------





## I/O Interfaces

### **Apple Desktop Bus**

One Apple Desktop Bus (ADB) port supporting up to three ADB input devices daisy-chained through a synchronous serial bus

### **PCI Expansion**

Two PCI expansion slots, compatible with all PCI 2.0 specification-compliant cards with the addition of Macintosh-OS-specific software driver. Nubus cards cannot be used in this expansion slot.

### **Communications**

One internal expansion slot for modem or Ethernet card (PCI bus configuration). Depending on configuration, a modem card may already be installed.





**TV Tuner**

One port for TV/FM tuner card. Depending on configuration, a tuner card may already be installed.

**Video-in**

One internal expansion slot for video input cards using NTSC, PAL, and SECAM. Depending on configuration, a video input card may already be installed. A 60-pin DAV connector on the video input card supports an optional video card for real-time video display, capture, and overlay. An adapter cable provides backward compatibility with DVA cards designed for the Power Macintosh 5200 computer.

**Graphics  
Acceleration (6500)**

2D and 3D built-in hardware graphics acceleration.



**Video-out****6400**

Supports these video modes:

640x480 resolution with 16-bit color, 60 Hz and 67 Hz vertical scan rate, and video input

800x600 resolution with 16-bit color, 60 Hz vertical scan rate, and video input at 8-bit or less color depth

800x600 resolution with 8-bit color, 72 Hz vertical scan rate, and no video input

832x624 resolution with 8-bit color, 75 Hz vertical scan rate, and video input

1024x768 resolution with 8-bit color, 60 Hz vertical scan rate, and no video input

**6500**

512x384 resolution with 32-bit color, 70 Hz vertical scan rate, and video input

640x480 resolution with 32-bit color, 60 Hz and 67 Hz vertical scan rate, and video input

640x870 resolution with 16-bit color, 75 Hz vertical scan rate, and video input





- 800x600 resolution with 32-bit color, 60 Hz vertical scan rate, and video input at 8-bit or less color depth
- 800x600 resolution with 32-bit color, 72 Hz vertical scan rate, and no video input
- 800x600 resolution with 16-bit color, 75 Hz vertical scan rate, and video input
- 832x624 resolution with 8-bit color, 75 Hz vertical scan rate, and video input
- 1024x768 resolution with 16-bit color, 60 Hz, 70 Hz, and 75 Hz vertical scan rate, and no video input
- 1152x870 resolution with 16-bit color, 75 Hz vertical scan rate, and video input
- 1280x960 resolution with 8-bit color, 75 Hz vertical scan rate, and video input
- 1280x1024 resolution with 8-bit color, 60 Hz and 75 Hz vertical scan rate, and video input





## Sound Output

16-bit stereo output featuring SRS 3D Surround Sound technology

One 3.5 mm sound output port for line-level devices, such as powered loudspeakers, on the back of the computer

One 3.5 mm headphone jack on the front of the computer

## Sound Input

16-bit stereo input

Sample rates of 11.025, 22.05, and 44.1 KHz

One 3.5 mm sound input port for stereo sound input. Supports the Apple PlainTalk Microphone that comes with some Macintosh computers, as well as non-Apple microphones. Also supports a standard stereo (miniplug-to-RCA) cable adapter for connecting stereo equipment to the computer.

**Note:** Does **not** support the Apple Omni microphone (the round microphone shipped with some earlier Macintosh models) or the attenuated RCA adapter provided with some models.



**Keyboard**

Supports all Apple Desktop Bus (ADB) keyboards

**Mouse**

Supports all models of the ADB mouse

**Controls**

Infrared remote control option

Front-panel pushbutton controls for volume and picture

Softpower control from keyboard

**SCSI**

One external standard SCSI port that supports up to six external SCSI devices (or up to five external SCSI devices if the optional Zip drive is installed)

**Serial**

Two RS-232/RS-422 serial GeoPort-compatible ports





## I/O Devices

### **Speaker**

Built-in, full-range, monophonic speaker. Stereo sound through attached external speakers or headphones or through the speaker built in to the monitor.





## Electrical

**Line Voltage** 90-130 or 180-264 VAC configured manually

**Frequency** 47-63 Hz

### Power

**6400** 220 W maximum continuous

**6500** 140 W maximum continuous





## Physical

### **Dimensions**

Height: 16" (406 mm)

Width: 7 13/16" (198 mm)

Depth: 16 7/8" (428 mm)

### **Weight**

44.5 lb. (20.18 kg) without CD-ROM

Weight varies depending on type of hard disk and other options.

Does not include monitor.







## Environmental

### Temperature

Storage: -40° F to 116.6° F (-40° C to 47° C)

6400

Operating: 50°-104° F (10°-40° C)

6500

Operating: 50°-97° F (10°-35° C)

### Humidity

Noncondensing, 5-95%

### Altitude

0-10,000 ft. (0-3,048 m)





## Troubleshooting

---

Performa/Power Macintosh  
6400 and 6500 Series





## General

The Symptom Charts included in this chapter will help you diagnose specific symptoms related to your product. Because cures are listed on the charts in the order of most likely solution, try the first cure first. Verify whether or not the product continues to exhibit the symptom. If the symptom persists, try the next cure. (Note: If you have replaced a module, reinstall the original module before you proceed to the next cure.)

If you are not sure what the problem is, or if the Symptom Charts do not resolve the problem, refer to the Flowchart for the product family.

For additional assistance, contact Apple Technical Support.





# Symptom Charts

## System

System  
intermittently  
crashes or hangs

- 1 Verify that system software is version 7.5.3 or later.
- 2 Verify that software is known-good.
- 3 Verify that software is PowerPC-compatible (contact developer).
- 4 Clear parameter RAM. Hold down Command-Option-P-R during startup, but before “Welcome to Macintosh” appears.
- 5 Disconnect all external devices attached (except monitor) and restart.
- 6 Replace DIMMs.
- 7 Replace logic board. Retain customer’s DIMMs.
- 8 Replace power supply.





## System

System does not start up

- 1 Reset logic board. Refer to Additional Procedures.
- 2 Replace power supply.
- 3 Replace logic board. Retain customer's DIMMs.

System does not start up from keyboard, but starts up from power switch

- 1 Check keyboard connection.
- 2 Verify keyboard as known-good.

Menu bar constantly flashes or system constantly beeps

Verify that front-panel control buttons are not jammed.





## Audio

Distorted or garbled sound

- 1 Check volume level.
- 2 Check volume level in Sound control panel.

No sound output from speaker

- 1 Check speaker connection to logic board.
- 2 Replace speaker assembly.
- 3 Attach headphones. If you hear sound through headphones, replace speaker assembly.





## Video

No video, fan is running

- 1 Check monitor connection.
- 2 Try known-good monitor.
- 3 Replace monitor-out card.
- 4 Remove all DRAM DIMMs and try replacing them one at a time to test. Replace any bad DIMMs.
- 5 Replace logic board. Retain customer's DIMMs.
- 6 Replace power supply.

Blurry image over entire screen at resolutions of 832 x 624 and higher.

Power Macintosh 6500 serial number falls within the range from XB708xxxxx to XB723xxxxx, replace audio/monitor connection subassembly (P/N 922-2996). To identify audio/monitor connection subassembly that needs replacing, see Additional Procedures chapter.





## Video

Pixels shimmer at edge of screen, dialog boxes, or windows.

If Power Macintosh 6500 serial number falls within the range from XB708xxxxx to XB719xxxxx, replace the logic board with a reworked logic board (P/N 661-1322 for 225 MHz, P/N 661-1332 for 250 MHz). To identify a reworked logic board, see Additional Procedures chapter.

Poor video output (misaligned or skewed video, low brightness, blurriness, etc.)

In Macintosh 6500 Monitors and Sound Control Panel, make sure resolution is set to 1152 x 870 or lower. See chart in Basics chapter for supported resolutions.







Video output from the NTSC Video Out Card intermittently turns black and white.

- 1 Zap PRAM.
- 2 Use a contact cleaner to clean the contacts at the end of the ribbon cable (on the NTSC video out card) that fits in the external video slot.
- 3 Replace the NTSC Video Out Card.

Video coming from the NTSC Video Out Card exhibits flickering lines shooting across the screen.

- 1 Zap PRAM.
- 2 Replace the NTSC Video Out Card.





## Floppy Drive

Audio and video are present, but internal floppy drive does not operate

- 1 Replace bad disk with known-good disk.
- 2 Replace floppy drive.
- 3 Replace logic board. Retain customer's DIMMs.

Disk ejects; display shows icon with blinking "X"

- 1 Replace bad system disk with known-good system disk.
- 2 Replace floppy drive.
- 3 Replace logic board. Retain customer's DIMMs.

Unable to insert disk all the way

- 1 Eject previously inserted disk by inserting opened paper clip into hole beside floppy drive.
- 2 Switch off system and hold mouse button down while switching system on (to complete eject cycle).
- 3 Replace floppy drive.





## Floppy Drive

Disk does not eject

- 1 Insert opened paper clip into hole beside floppy drive.
- 2 Switch off system and hold mouse button down while switching system on (to complete eject cycle).
- 3 Replace floppy drive.

Internal floppy drive runs continuously

- 1 Replace bad disk with known-good disk.
- 2 Replace floppy drive.
- 3 Replace logic board. Retain customer's DIMMs.





## Hard Drive

Internal or external hard drive does not spin up

- 1 Verify that all hard drive connections are secure.
- 2 Verify that external drive is properly terminated.
- 3 Reseat logic board.
- 4 Replace internal IDE hard drive.
- 5 Replace logic board. Retain customer's DIMMs.
- 6 Replace chassis/wiring harness.

**Note:** The chassis/wiring harness is not a separate replacement part. Order the metal chassis that contains the chassis/wiring harness.

Internal hard drive runs continuously

- 1 Verify that system software is version 7.5.3 or later.
- 2 Replace hard drive cable.
- 3 Replace internal hard drive.
- 4 Replace logic board. Retain customer's DIMMs.





## Hard Drive

Hard drive not found when booted from CD-ROM drive

Use Drive Setup to attempt to recognize or mount hard drive.

Flashing ? appears at startup in 6400/180 or 6400/200 with 1.6 GB (p/n 661-1107) or 2.4 GB (661-1202) ATA hard drive , and may be corrected with restart.

- 1 Be sure system software is not corrupted. See the Software Troubleshooting document in the HW-SW Procedures topic under the Troubleshooting tab on the Service Source CD startup screen.
- 2 Remove the 1.6 GB or 2.4 ATA hard drive and look at the serial number on the bar code label.
- 3 If serial number is within range XXX**6099**XXXXX to XXX**6131**XXXXX, replace hard drive.





## CD-ROM Drive

CD-ROM drive does not accept disc

- 1 If compact disc is dirty or damaged, use known-good compact disc.
- 2 Replace CD-ROM drive.

Volume control does not operate correctly when playing Audio CD, but does work when playing system sounds.

Check Sound control panel setting.

Spinning disc causes vibration sounds in 12x CD-ROM drive.

The 12x CD-ROM drive reads CD-ROM discs very quickly, and because of the drive's high rotation speed, unexpected vibration sounds may occur. This sound is normal for a 12-speed (12x) CD-ROM drive.





## CD-ROM Drive

Computer cannot  
mount known-good  
CD-ROM discs

- 1 Check that CD-ROM drive software is installed correctly.
- 2 Reseat CD-ROM adapters.
- 3 Check SCSI ID setting. (Internal CD-ROM drive was originally set to 3 at factory.)
- 4 Replace CD-ROM drive.
- 5 Replace chassis/wiring harness.

**Note:** The chassis/wiring harness is not a separate replacement part. Order the metal chassis that contains the chassis/wiring harness.

When an internal and  
external SCSI device  
are present, only one  
starts up

Verify that ID switch setting on external SCSI device is higher than 0. Verify that ID setting on external SCSI device does not duplicate ID settings on other external SCSI devices.





## CD-ROM Drive

CD not recognized or no power.

- 1 In a Power Macintosh 6500, reseal the logic board to reestablish logic board-to-chassis connection.
- 2 Remove hard drive to see white pull tab. If anything but Foxconn is printed on pull tab, replace the chassis (P/N 922-2707).
- 3 Check that power supply is set to the correct voltage.
- 4 Replace power supply if switch is in the incorrect position.







## Peripheral

Cursor does not move

- 1 Restart system.
- 2 Check mouse connection.
- 3 If mouse was connected to keyboard, connect mouse to rear ADB port and disconnect keyboard. If mouse works, replace keyboard.
- 4 If mouse does not work in ADB port, replace mouse.
- 5 Reseat logic board.
- 6 Replace logic board. Retain customer's DIMMs.

Cursor moves, but when you click the mouse, nothing happens

- 1 Replace mouse.
- 2 Reseat logic board.
- 3 Replace logic board. Retain customer's DIMMs.





## Peripheral

Cannot double-click mouse to open application, disk, or server

- 1 Check mouse speed on Mouse control panel.
- 2 Unplug battery from logic board, wait 20 seconds, plug in battery, and restart computer.
- 3 If mouse was connected to keyboard, connect mouse to rear ADB port and disconnect keyboard. If mouse works, replace keyboard.
- 4 If mouse does not work in ADB port, replace mouse.
- 5 Replace logic board. Retain customer's DIMMs.

No response to any key on keyboard

- 1 Verify that system software is version 7.5.3 or later.
- 2 Check keyboard connection to ADB port.
- 3 Replace keyboard.
- 4 Reseat logic board.
- 5 Replace logic board. Retain customer's DIMMs.





## Peripheral

Known-good  
StyleWriter does not  
print

- 1 Verify that Chooser is set correctly.
- 2 Verify that printer driver and system software are not corrupt.
- 3 Verify system software is version 7.5.3 or later.
- 4 Replace printer interface cable.
- 5 Replace logic board. Retain customer's DIMMs.

Known-good  
LaserWriter does not  
print

- 1 Verify that Chooser is set correctly.
- 2 Verify that printer driver and system software are not corrupt.

Doesn't recognize  
SCSI device

- 1 Check for proper SCSI termination.
- 2 Check that the SCSI cable is good and firmly connected.
- 3 Check the SCSI device manual for required software.
- 4 Use the 6360/64xx/54xx Update disk to correct a possible SCSI timing problem.





## Zip Drive

Zip drive not  
displayed on desktop  
when disk inserted

- 1 Insert known-good Zip disk.
- 2 Check that drive cable connections are secure.
- 3 Reinstall system software.
- 4 Replace Zip drive.

Type 4 errors appear

- 1 Check that drive cable connections are secure.
- 2 Replace Zip drive.





## Modem

Communications software doesn't work with newly installed modem.

Some Performa 6400/180 and 6400/200 computers shipped with internal GeoPort modems and some with internal Global Village modems. If the modem wasn't replaced like-for-like, the communications software is incompatible with the modem.

Identify the modem originally shipped in the computer by the last three characters of the serial number found in this table.

<b>Modem</b>	<b>6400/ 180</b>	<b>6400/ 200</b>
Global Village Platinum	7U7	836
GeoPort	95R	95S

If the wrong type of modem has been installed in the computer, replace it with the type of modem originally shipped in the





computer.

## Miscellaneous

No audio, and no drive operation

- 1 Connect power cable.
- 2 Switch power on.
- 3 Replace power cable.
- 4 Replace logic board. Retain customer's DIMMs.

"Sad Macintosh" icon

- 1 Start up from known-good disk.
- 2 Replace RAM DIMMs on logic board.
- 3 Replace logic board. Retain customer's DIMMs.





## Miscellaneous

Screen shows “Sad Macintosh” icon and black vertical lines; screeching sound

- 1 Replace RAM DIMMs on logic board.
- 2 Replace logic board. Retain customer’s DIMMs.

Headphone jack does not operate correctly

- 1 Verify that headphone jack is seated properly.
- 2 Replace front panel control board.
- 3 Replace chassis/wiring harness.

**Note:** The chassis/wiring harness is not a separate replacement part. Order the metal chassis that contains the chassis/wiring harness.





## Miscellaneous

When installing software, error message appears: “Unable to decompress file ‘xxxxx’ because of a data mismatch error.” System hangs, freezes, or Type 10 error requires restart.

If serial number of Power Macintosh 6500 falls within the range from XB708xxxxx to XB718xxxxx, and logic board is manufactured by OPC, and L2 cache DIMM is incompatible with OPC boards, replace L2 cache with P/N 661-1477. See details for identifying OPC logic boards and incompatible L2 cache DIMMs in Additional Procedures chapter.







## Take Apart

---

Performa/Power Macintosh  
6400 and 6500 Series





## Front Bezel

No preliminary steps are required before you begin this procedure.

- 1 Put the front of the computer on a workbench edge directly in front of you.





- 2 Push up the release tabs under the front bezel.

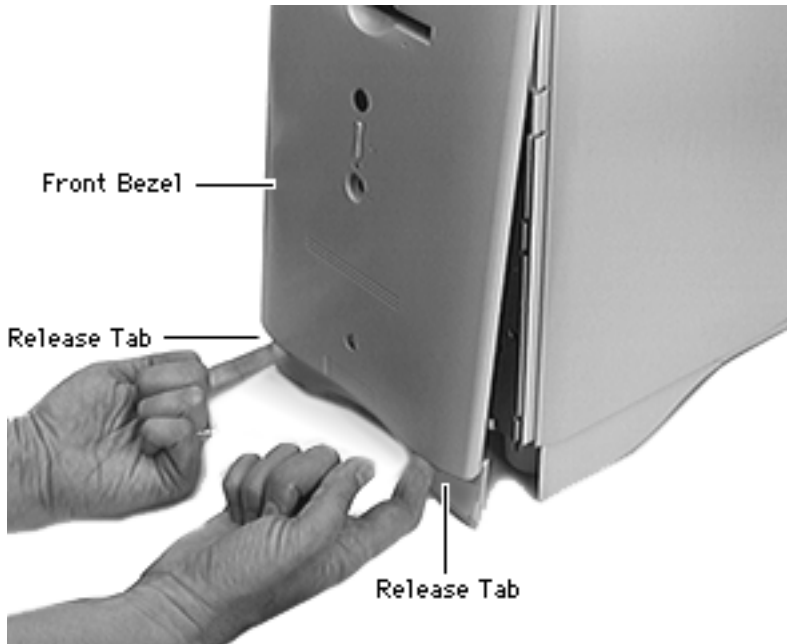

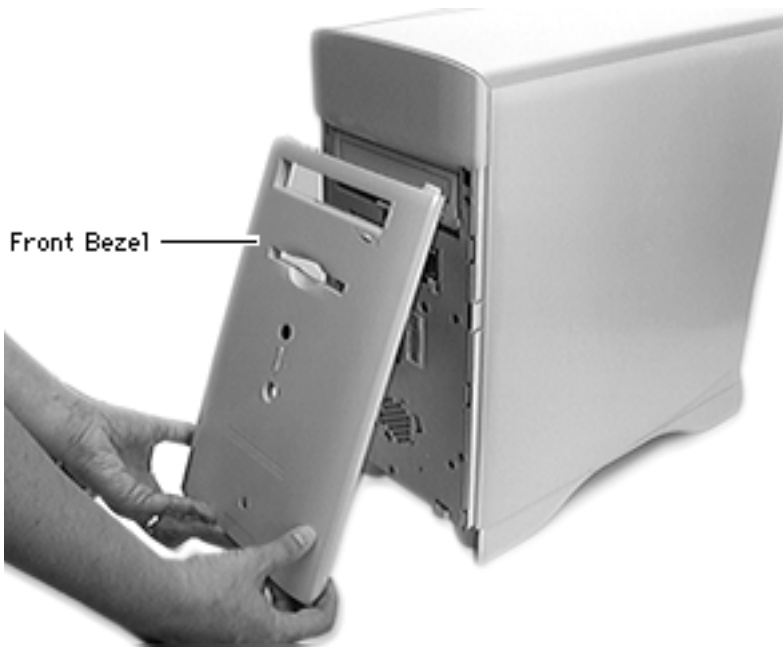

- 3 Pull the bottom of the front bezel out and away from the computer.

**Replacement Note:** Align the two plastic tabs at the top of the front bezel with the slots in the front metal chassis below the expansion bay cover. Press the front bezel into place. Press the bottom corners and the middle of the panel on each side to be sure it is firmly in place.



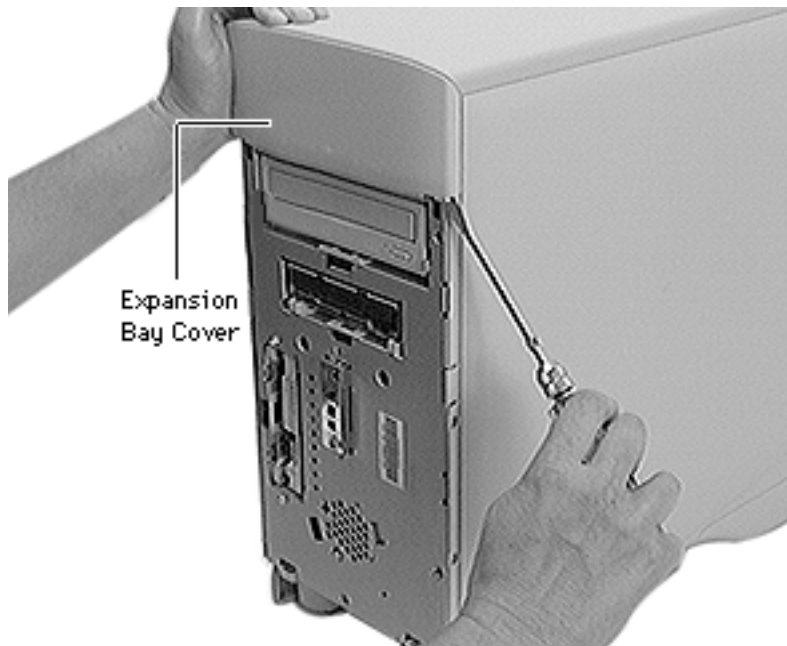

## Expansion Bay (or Zip Drive) Cover

Before you begin, remove the front bezel.

**Note:** Expect a loud cracking noise as you remove the bay cover.

- 1 Press on one side of the bay cover.
- 2 Insert a screw driver under the lower corner of the opposite side, and pry off the cover plate.

**Note:** Alternatively, you



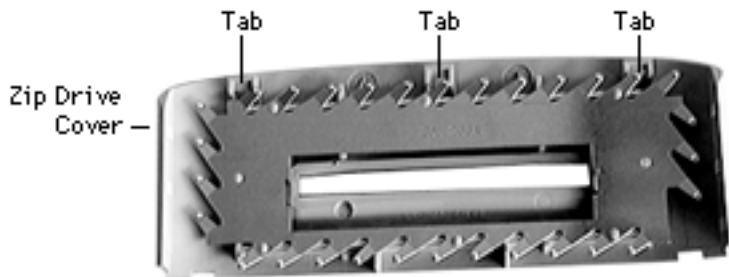
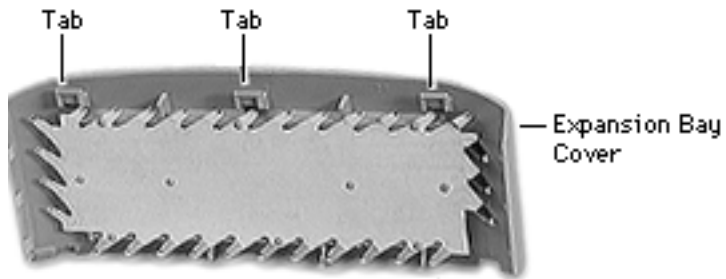

can insert screw drivers under each lower corner of the cover plate and pull the sides outward to release it.

**Replacement Note:** Align the three plastic tabs at the top of the bay cover with slots under the top cover.



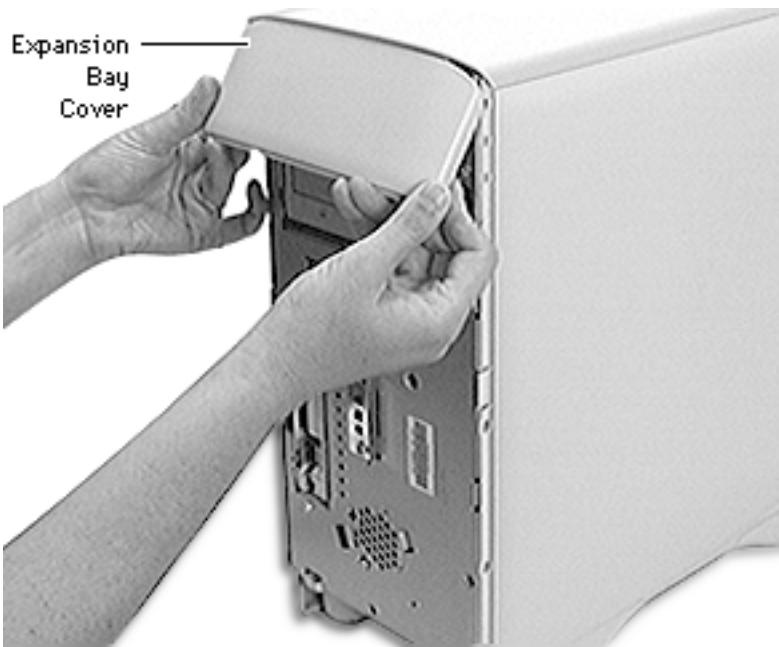

**Replacement Note:** Press the cover into place. You know that the bay cover is secure when you see a space of about 1 mm between the cover and the other plastic panels above and at the sides of the cover.





## Top Cover

Before you begin, remove the following:

- Front bezel
- Expansion bay cover

**Caution:** Never operate the computer with the top cover removed. Failure to comply may result in irreparable damage to internal components.

- 1 Remove the captive cover screw on the rear panel.







- 2 Slide the top cover back about one-half inch.
- 3 Lift the top cover from the computer.

**Replacement Note:** Place the top cover on top of the chassis, about a half inch from the front of the computer. Slide the cover forward until it is firmly in place. Replace the captive cover screw on the rear panel.





## Side Panels

Before you begin, remove the following:

- Front bezel
- Expansion bay cover
- Top cover

**Note:** This procedure shows removing the left panel. Remove the right panel following the same steps.

- 1 With a screw driver, pry up the plastic tab at the front middle of the left panel far enough to clear the metal panel.

Plastic Tab

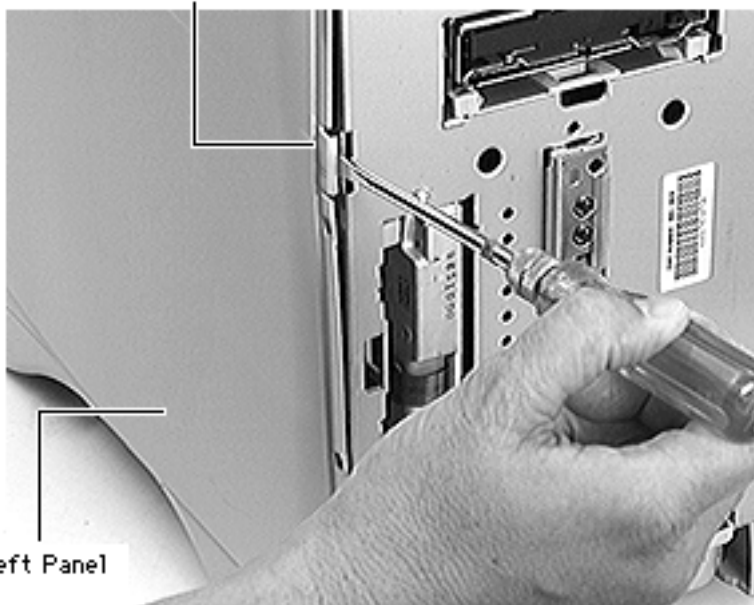

Left Panel





Left Panel

- 2 Slide the panel back about an inch.
- 3 Remove the left panel from the computer.



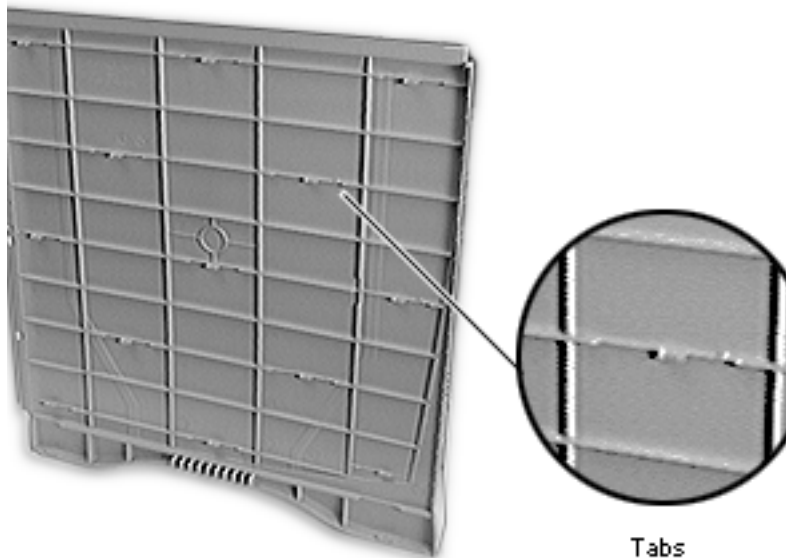

**Replacement Note:** Place the left panel over the left metal panel, about an inch from the front of the computer. Be sure the panel covers the feet at the bottom. Slide the panel forward to engage the plastic tabs with the slots in the metal panel and push the panel firmly into place.





## Rear Panel

Before you begin, remove the following:

- Front bezel
- Expansion bay cover
- Top cover
- Left panel
- Right panel
- Logic board

**Caution:** Review the ESD precautions in Bulletins/ Safety.

- 1 Remove the two screws that secure the power supply to the rear panel.

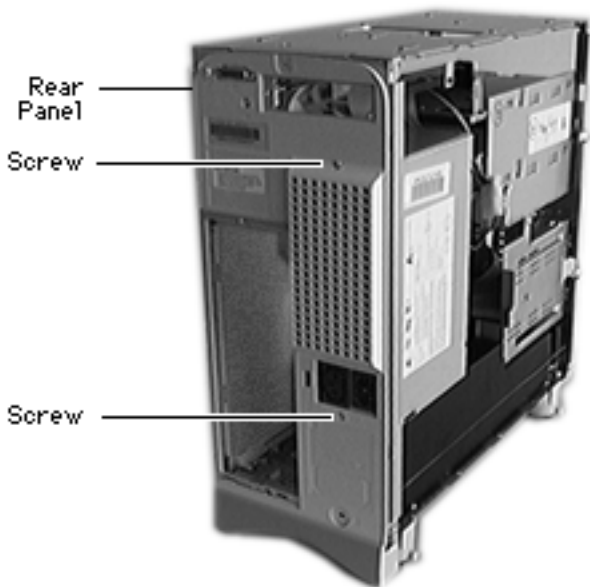

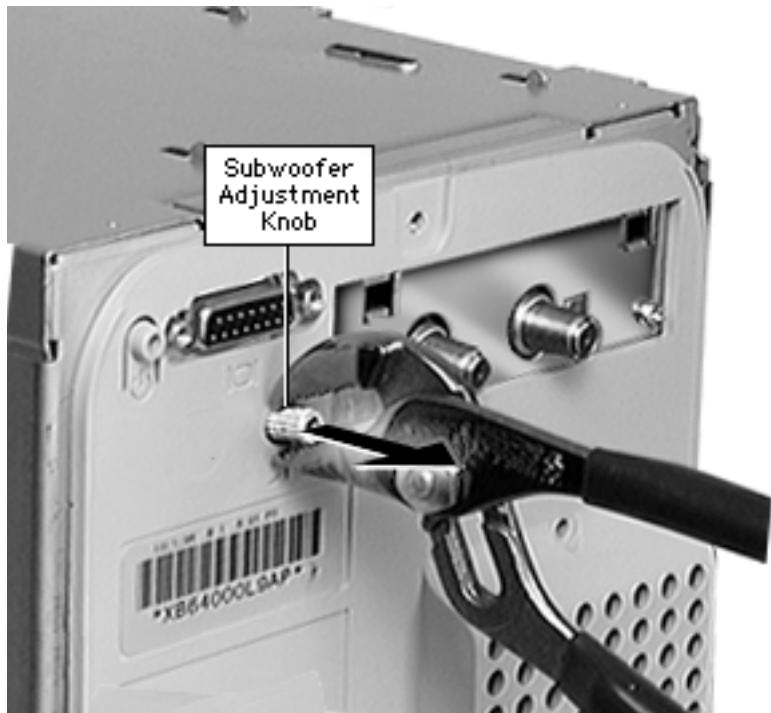

- 2 Remove the subwoofer adjustment knob by grasping it firmly with a pair of pliers and pulling straight out.





- 3 Push up the bottom of the rear panel to release the two tabs that fasten it to the chassis.

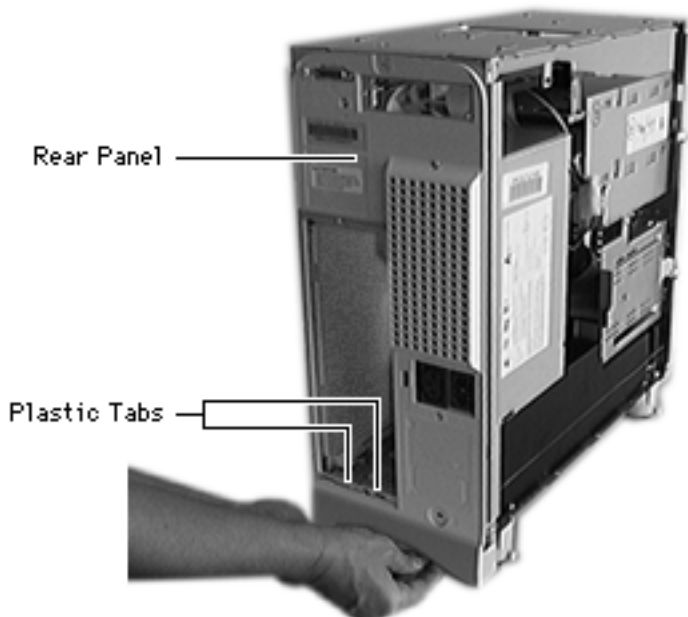

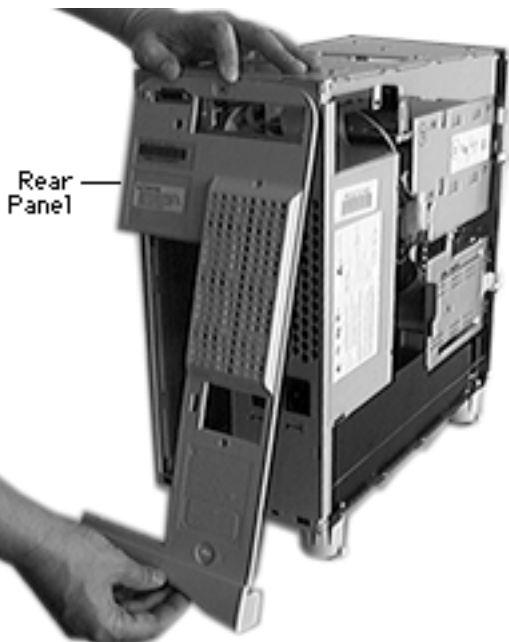

- 4 Push the rear panel up slightly and remove it from the computer.





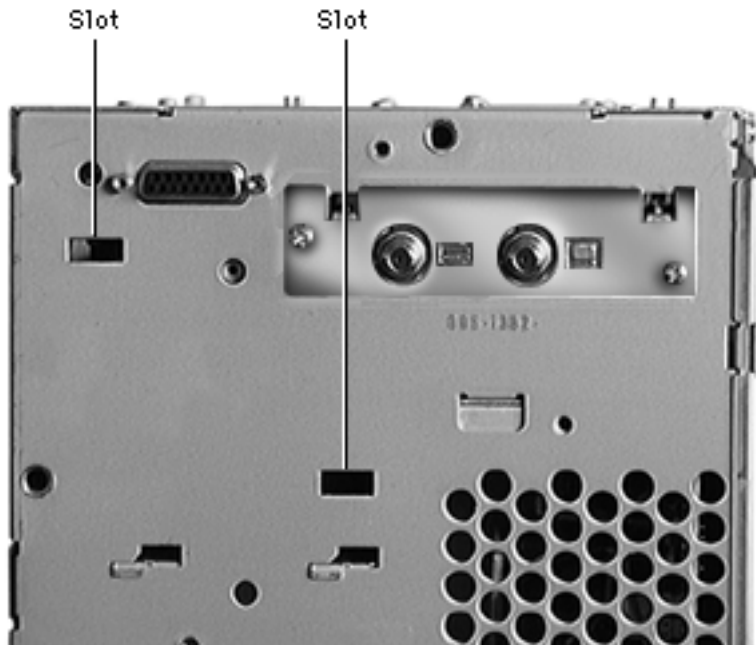

**Replacement Note:** Two plastic tabs on the upper part of the rear panel must fit into two slots in the rear chassis. Position the top of the rear panel over the back of the chassis and press downward to insert the tabs into the slots. Press along the sides and bottom of the rear panel to snap it into place.





## Left Metal Panel

Before you begin, remove the following:

- Front bezel
- Expansion bay cover
- Top cover
- Left panel

**Caution:** Review the ESD precautions in Bulletins/ Safety.

- 1 Remove the screws that fasten the left metal panel to the computer.

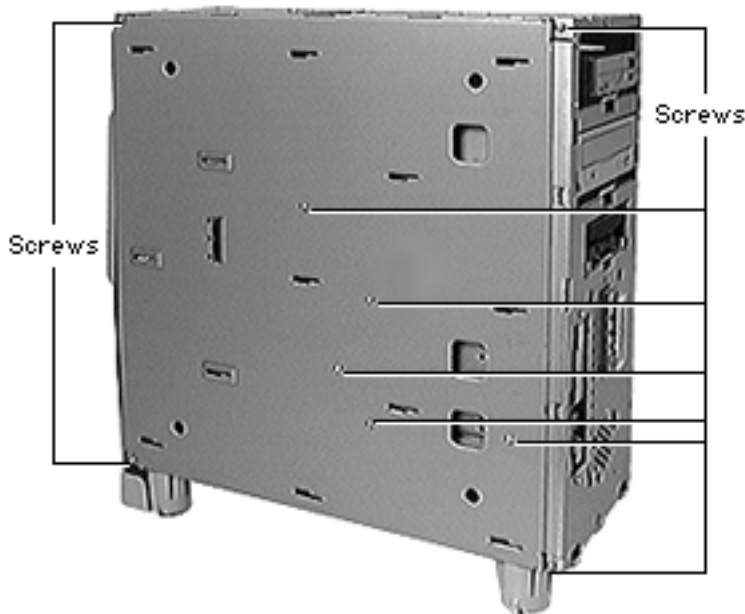

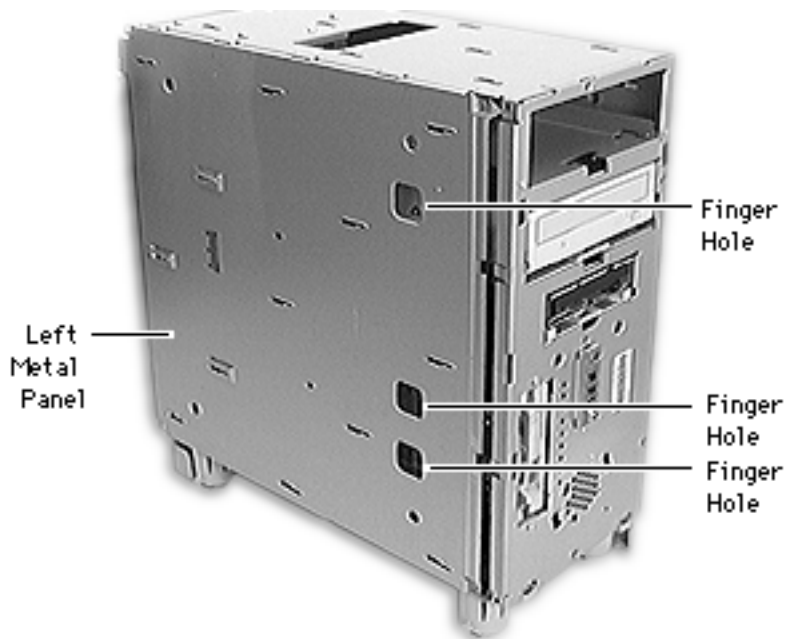

- 2 Place your fingers in the metal panel holes near the front and pull back about an inch to release the metal panel.





- 3 Remove the metal panel from the computer.

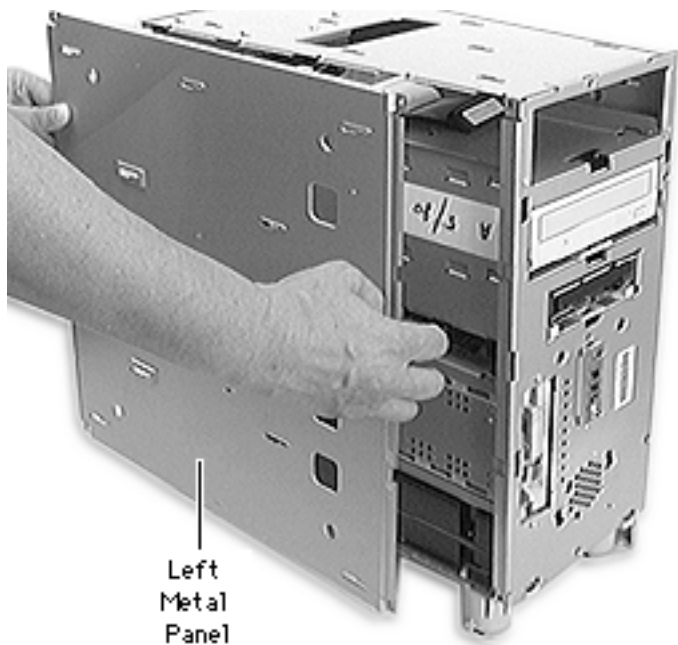

Left  
Metal  
Panel



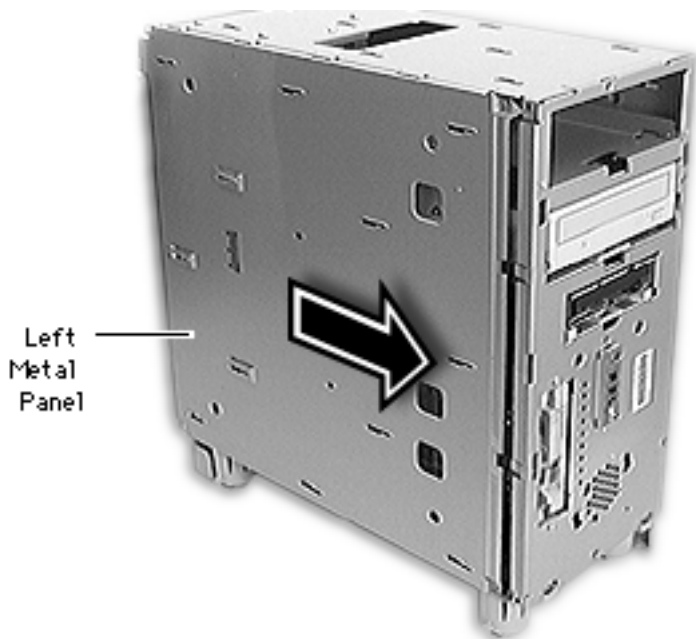

Left  
Metal  
Panel

**Replacement Note:** Place the left metal panel over the left side of the computer, about an inch from the front. Slide the metal panel forward until it snaps into place. Replace the metal panel screws.





## CD-ROM Drive

Before you begin, remove the front bezel.

**Caution:** Review the ESD precautions in Bulletins/Safety.

**Note:** The CD-ROM drive is located in the top drive bay.

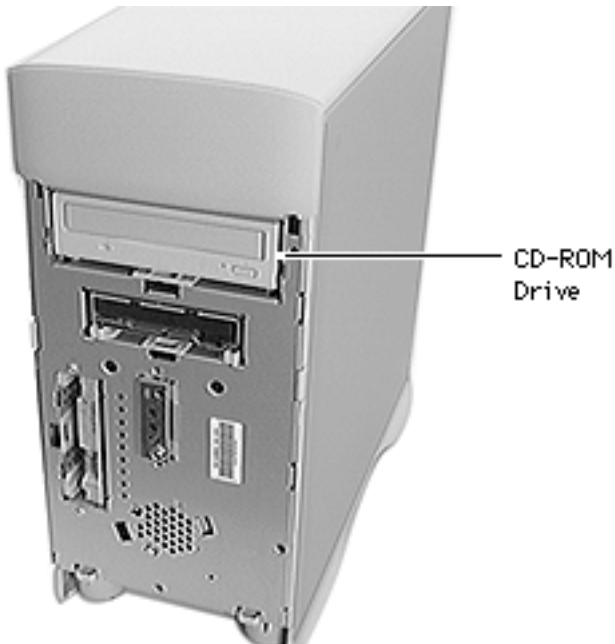

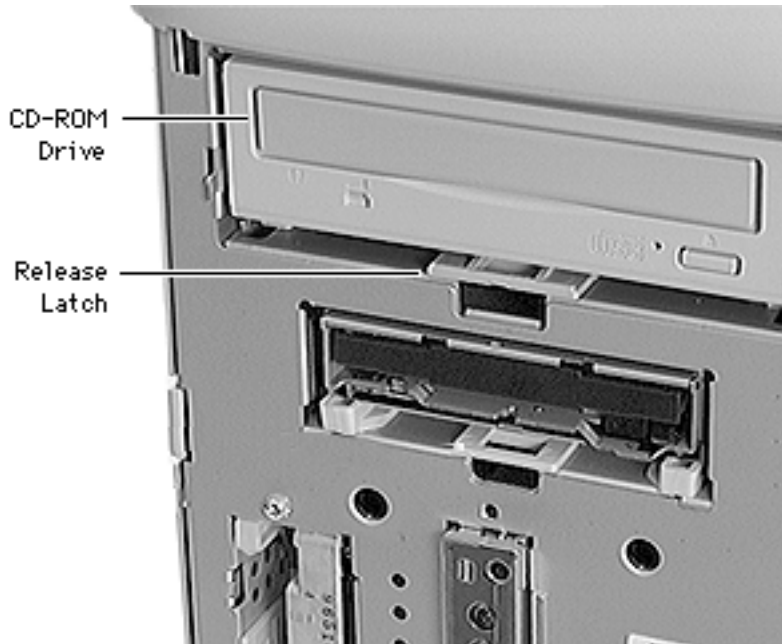

With needle nose pliers, pull up the release latch beneath the CD-ROM drive and slide the drive out of the computer.

**Note:** Be sure to remove the CD-ROM drive from its carrier before returning the drive to Apple.





## Floppy Drive

Before you begin, remove the front bezel.

**Caution:** Review the ESD precautions in Bulletins/ Safety.

**Note:** The floppy drive is located in the second drive bay from the top.

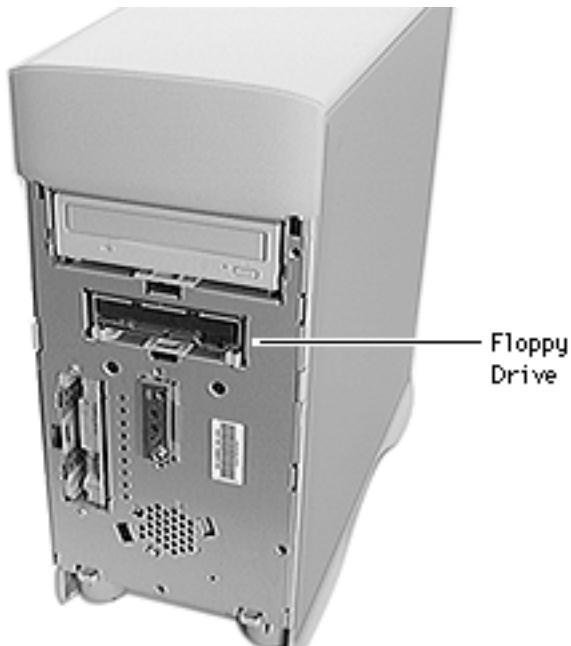



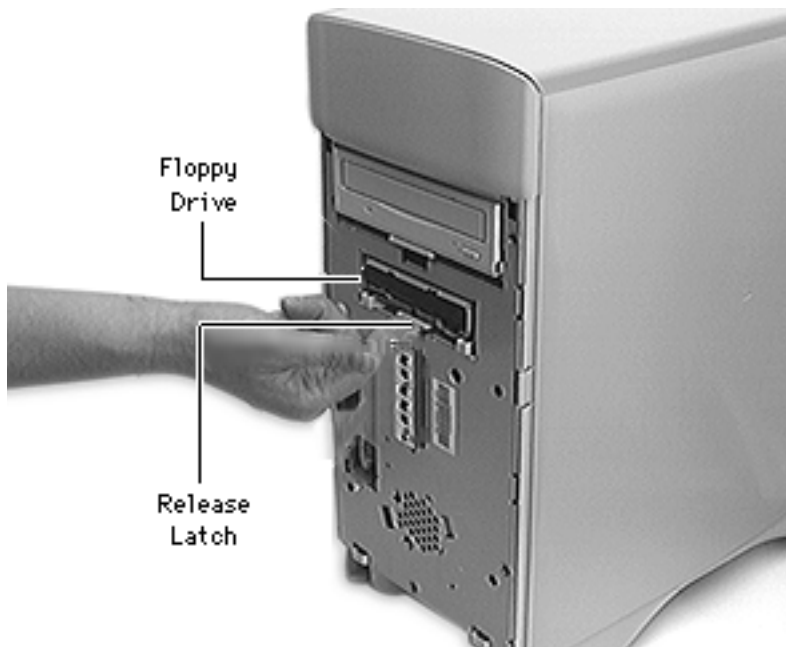

- 1 Push up the release latch beneath the floppy drive and slide the floppy drive forward just far enough to reach the cable on the back.



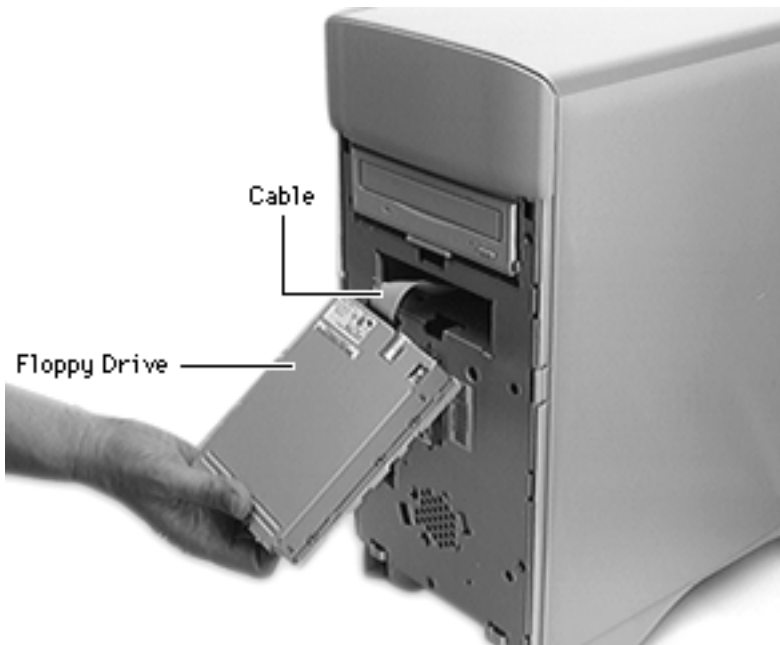

- 2 Disconnect the floppy drive cable from the back of the floppy drive.

**Replacement Note:** If you are replacing the floppy drive, remove the EMI gasket from the defective drive and attach the gasket in the center of the replacement drive's top surface, with the "V" of the gasket pointing at the front edge of the drive. If the old gasket won't stick, order a new gasket (p/n 922-1895).





## Replacing the Floppy Drive

Before you begin, remove the following:

- Logic board
- Front bezel
- Expansion bay cover
- Top cover
- Left panel
- Left metal panel

### **Replacement Caution:**

Carefully push the drive into the bay. The cable may be damaged if caught between the drive and the metal





chassis, resulting in serious damage to the equipment.

- 1 Connect the floppy drive cable to the back of the floppy drive.
- 2 Reach through the open side into the back of the floppy drive bay, and grasp the floppy drive cable.
- 3 Keep tension on the floppy drive cable while sliding the floppy drive into the floppy drive bay.





## Hard Drive

Before you begin, remove the front bezel.

**Caution:** Review the ESD precautions in Bulletins/ Safety.

**Note:** The hard drive is located in the lower left drive bay.



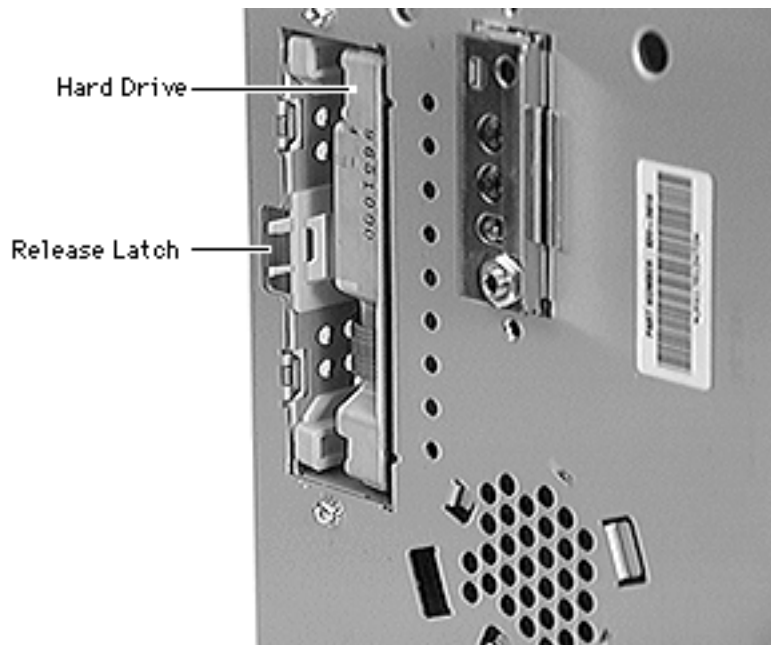

- 1 Press the hard drive release latch to the right.
- 2 Slide the hard drive forward far enough to reach the cables connected to the back of the hard drive.



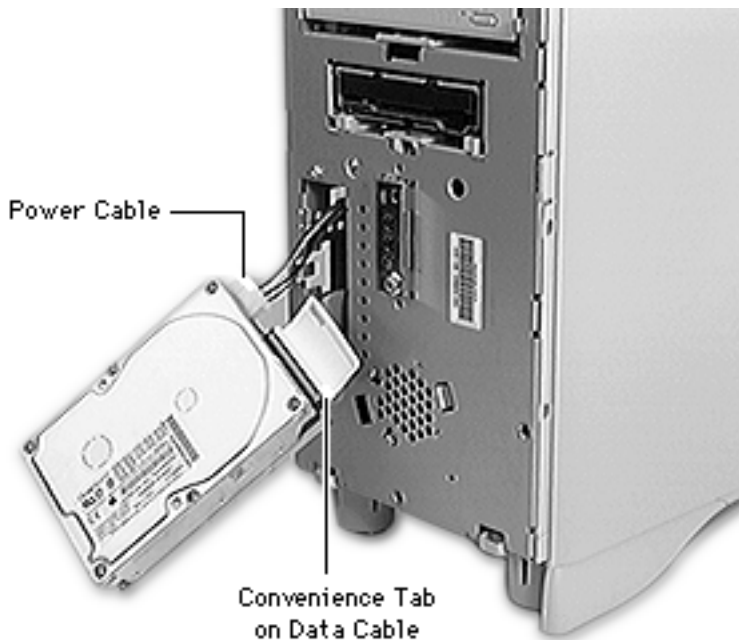

- 3 Disconnect the power cable from the hard drive.
- 4 Pull the convenience tab to disconnect the data cable from the hard drive.

**Note:** For information about removing the hard drive from its carrier and returning drives, cables, and carriers to Apple, refer to Additional Procedures in the Hard Drives manual.



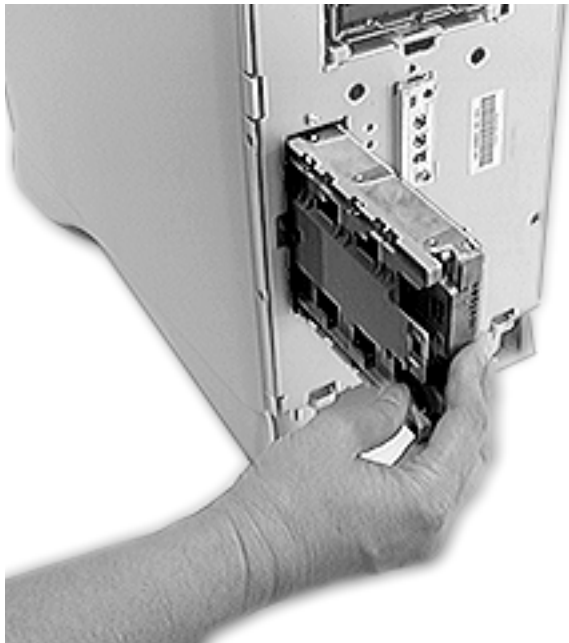

**Replacement Caution:**

Carefully push the drive into the bay. The cable may be damaged if caught between the drive and the metal chassis, resulting in serious damage to the equipment.

**Replacement Note:**

Reconnect the power cable and data cable. Align and insert the hard drive vertically so that it engages the guides on the top and bottom left side of the hard drive bay.







## Front Panel Control Board

Before you begin, remove the following:

- Front bezel
- Hard drive

**Note:** It isn't necessary to remove the cables from the hard drive.

**Note:** The front panel control board is located to the right of the hard drive.

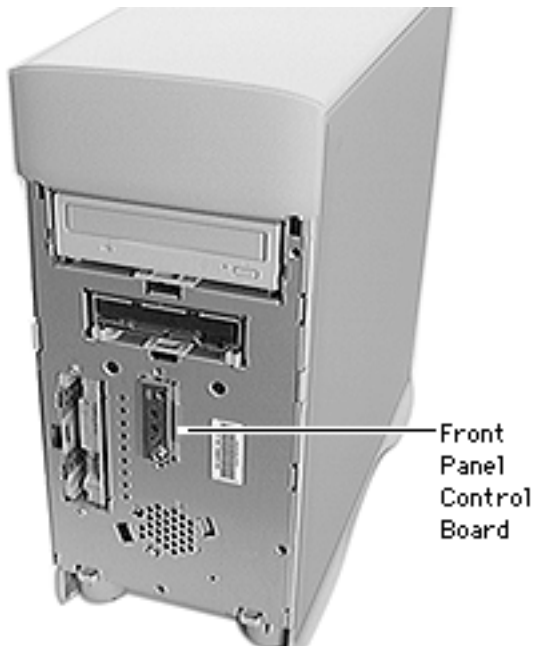

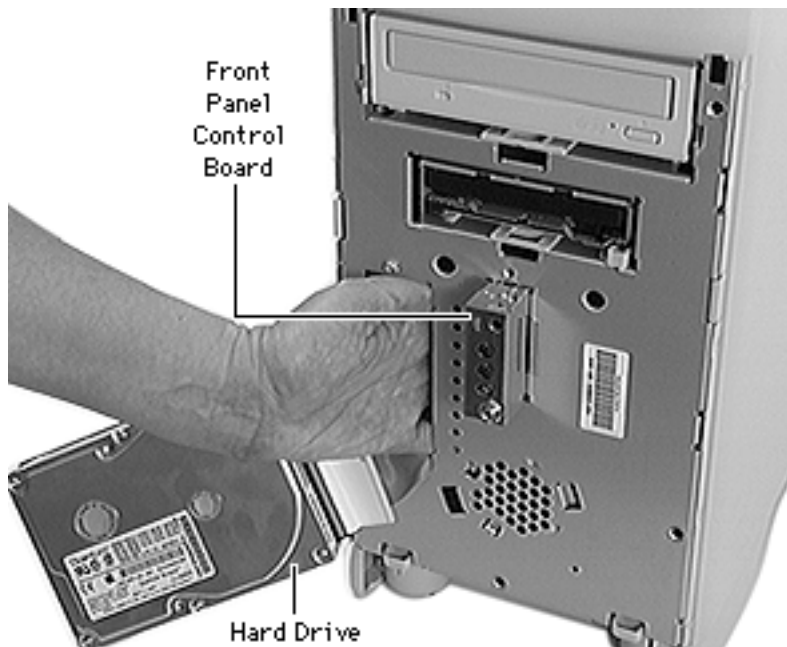

**Caution:** Review the ESD precautions in Bulletins/ Safety.

- 1 Reach through the hard drive bay and behind the front panel control board to push the board forward.



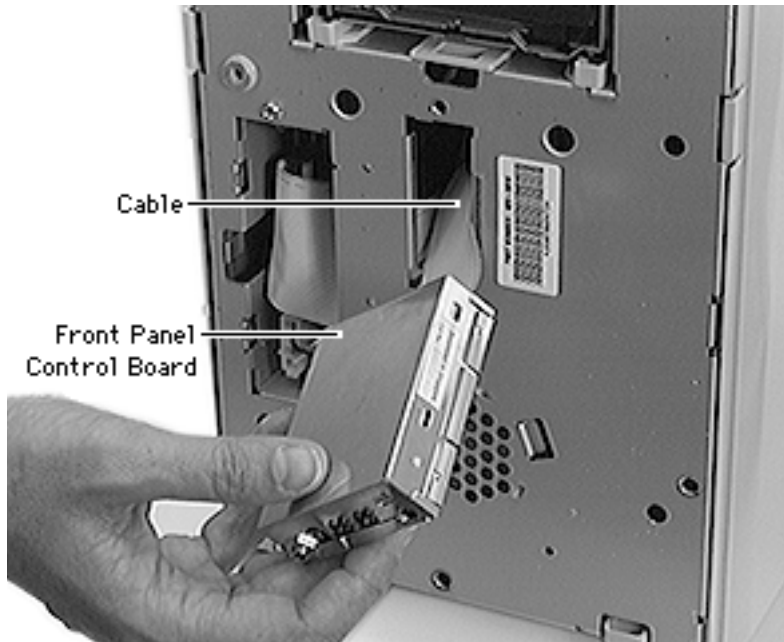

- 2 Pull the front panel control board out of the computer far enough to reach the cable on the back.
- 3 Remove the cable attached to the back of the front panel control board.





## Zip Drive

Before you begin, remove the following:

- Front bezel
- Zip drive cover





- 1 Pull up the release tab and bring the Zip drive forward enough to reach the cables on the back.



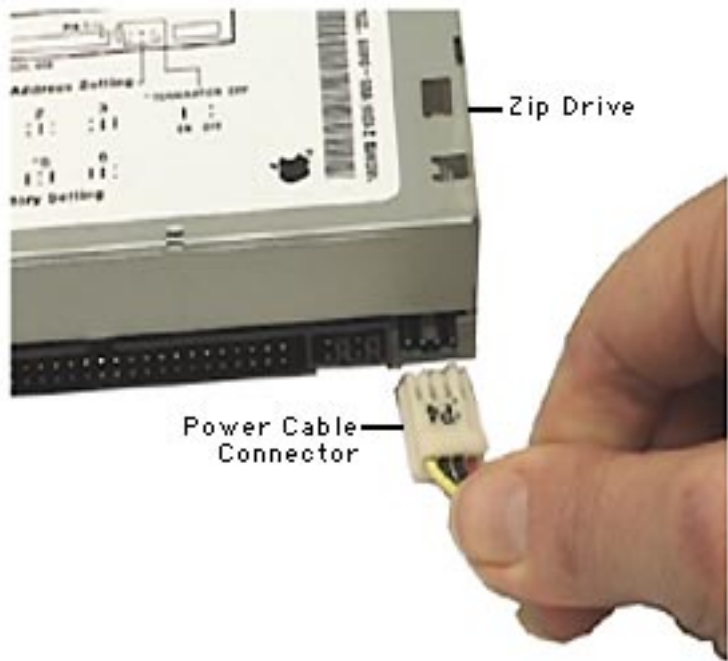

- 2 Disconnect the power and SCSI cables from the Zip drive.

**Caution:** The power cable connector is a keyed connector. If it is removed with too much force, the keyed latch can break. With a broken latch, the connector can be installed incorrectly and cause the drive to fail. Reinsert the power cable connector with the metal contacts facing up, as shown.





Power Cable

SCSI Cable



- 3 Remove the four screws that secure the drive to the carrier.

**Replacement Note:** Plug cables securely into the Zip drive. Avoid pulling the cables against the enclosure as this can damage the cables. Hold the power cable up and to the left while aligning carrier with guide rails. Push the drive inside the enclosure. Lock the carrier release tab down into the Zip drive bay cutout.





## Logic Board

No preliminary steps are required before you begin this procedure.

**Note:** If you are looking at the back of the computer, the logic board is located on the left.

**Caution:** Review the ESD precautions in Bulletins/ Safety.







- 1 Remove the two screws that secure the logic board to the rear panel.

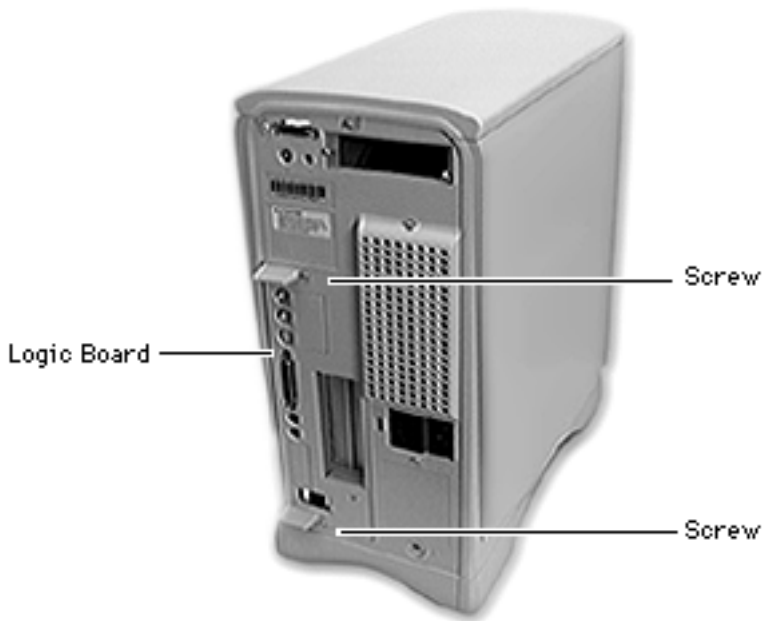

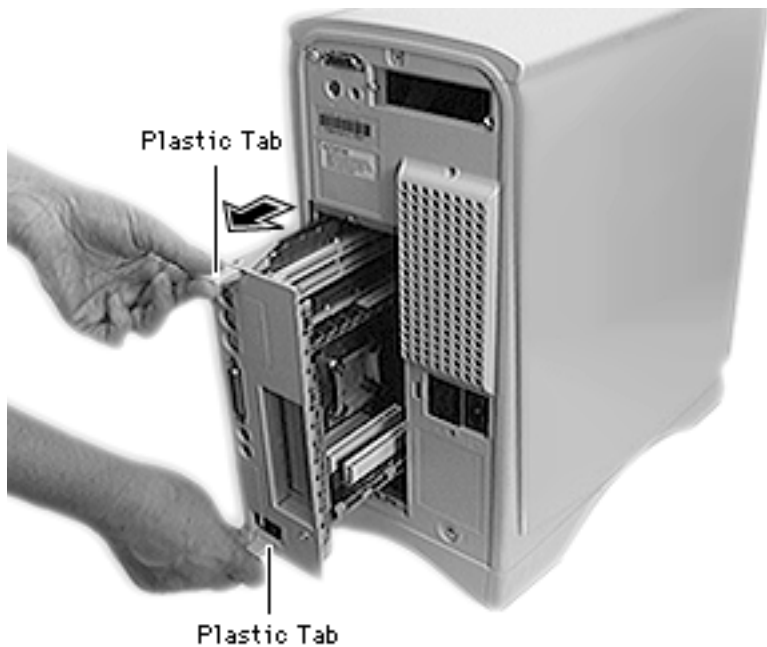

- 2 Grasp the two plastic tabs, and gently pull the logic board all the way out of the computer.



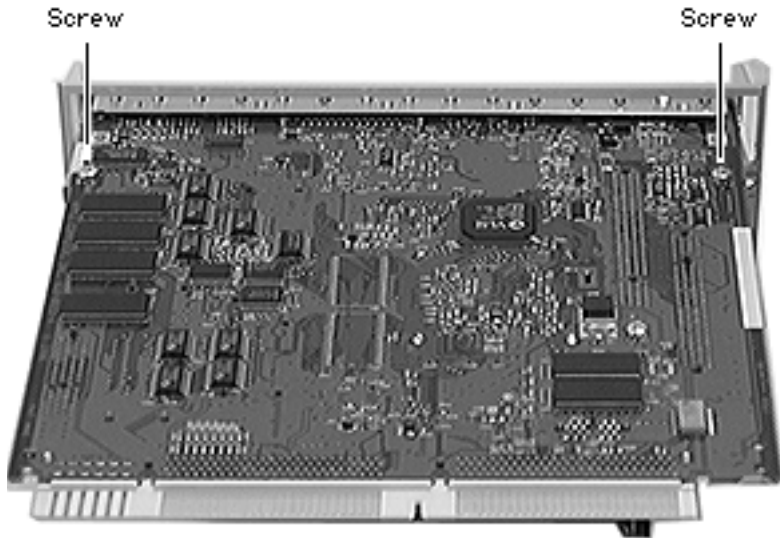

**Note:** Perform the following steps only if you are replacing a defective logic board.

- 3 Remove the two Phillips screws that secure the fence to the solder side of the logic board.



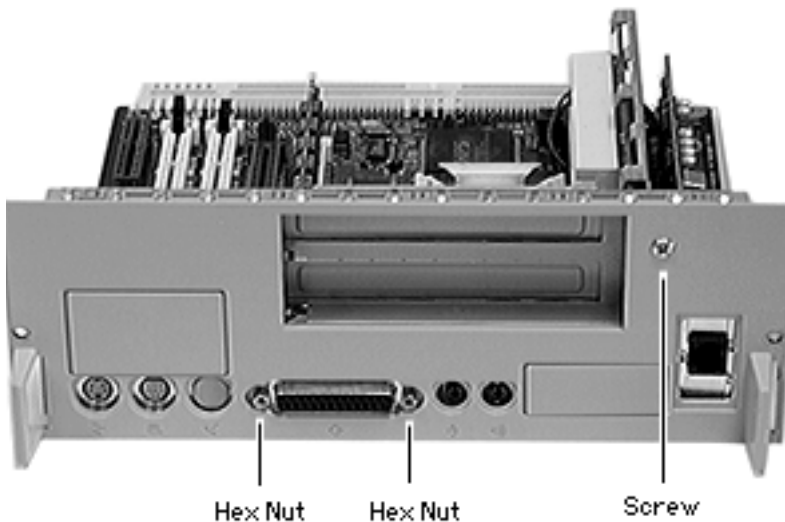

- 4 Using a hex nut screw driver, remove the two hex nuts that secure the logic board fence to the SCSI connector.
- 5 Remove the Phillips screw that secures the logic board fence to the right angle PCI adapter board.





- 6 Separate the logic board fence from the logic board.



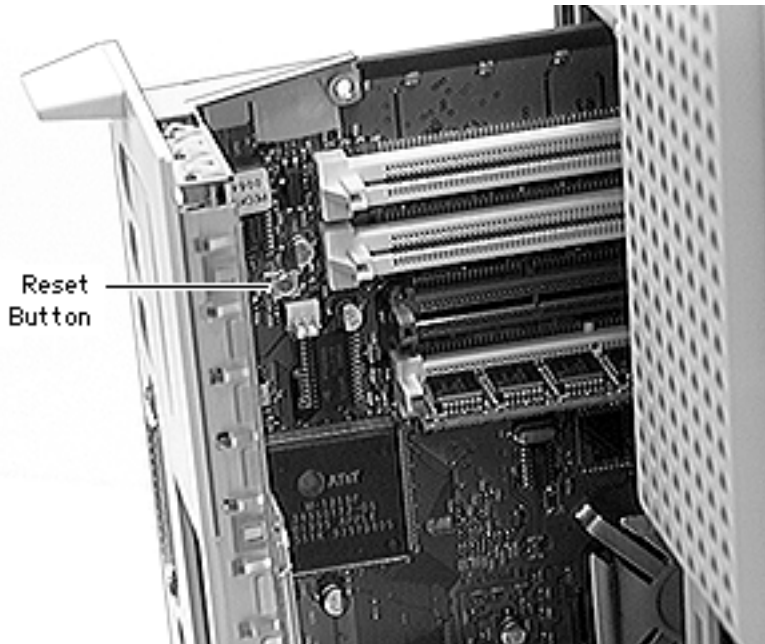

**Replacement Note:** Align and insert the logic board vertically so that it engages the guides on the top and bottom of the logic board slot. Press the reset button, and push on the vertical logic board fence until it snaps into place. Replace the two screws.

**Note:** Remove the DRAM and high performance module before returning the board to Apple. Do **not** remove the ROM SIMM.





## Video Card

Before you begin, remove the following:

- I/O door
- Logic board

- 1 Remove the screw that secures the video card to the logic board fence.
- 2 Pull the video card out of the video-in slot.

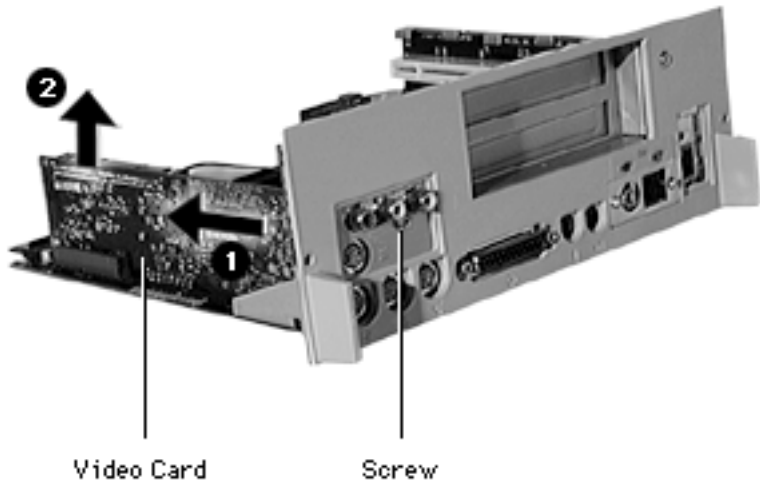



## PCI Covers

Before you begin, remove the following:

- I/O door
- Logic board

- 1 Remove the screws that secure the PCI covers to the logic board fence.

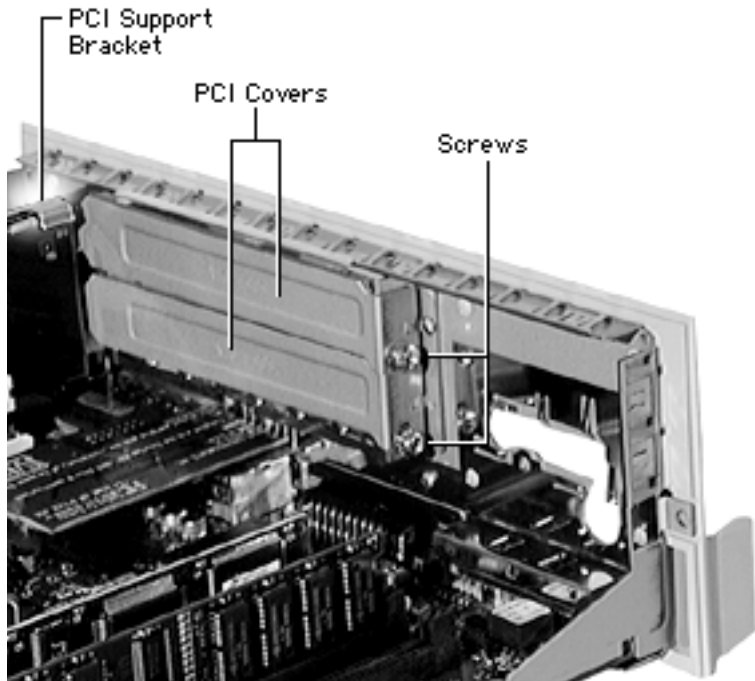



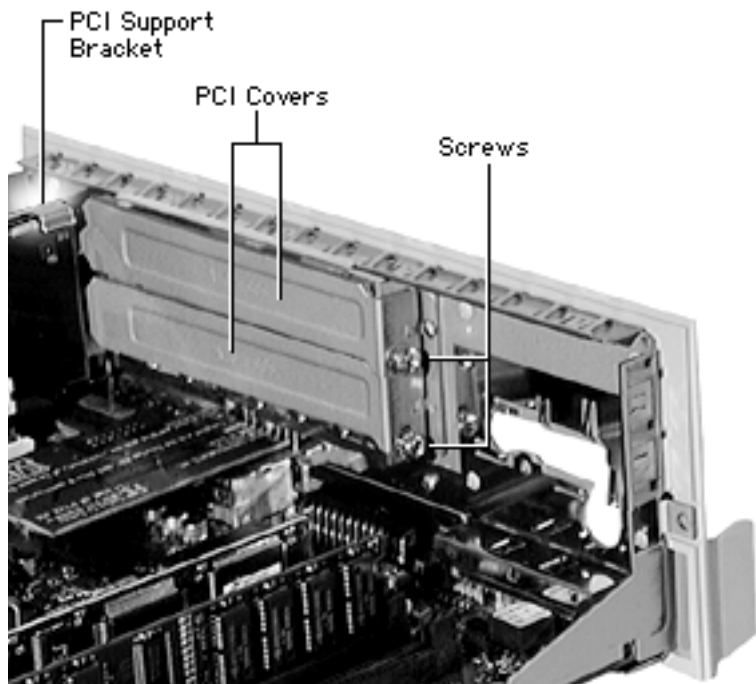

- 2 Pull the other ends of the PCI covers out of the PCI support bracket.





## PCI Adapter

Before you begin, remove the following:

- I/O door
- Logic board
- PCI covers

- 1 Remove the screw that secures the PCI support bracket to the logic board fence.

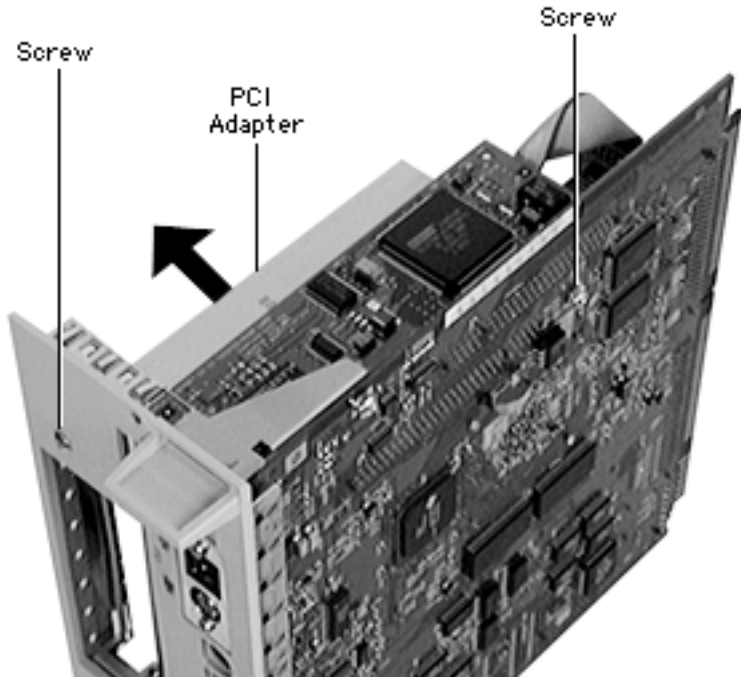

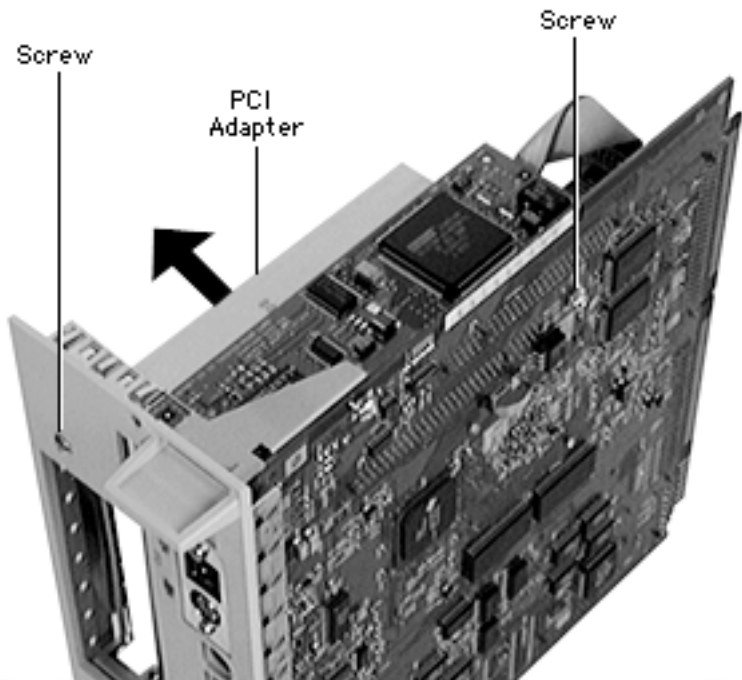

- 2 Remove the screw that secures the PCI support bracket to the logic board.
- 3 Pull up on the PCI adapter and support bracket to remove them from the logic board.



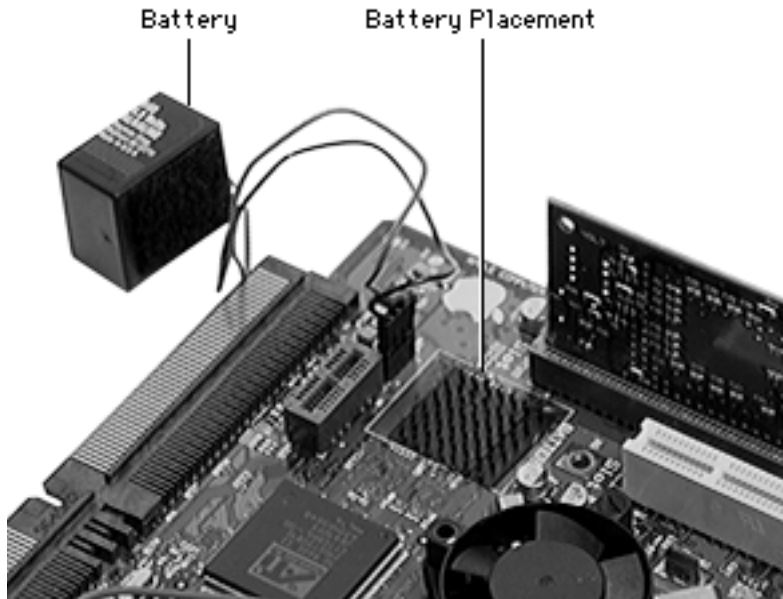

**Replacement Note:** It is easier to replace the PCI support bracket if you temporarily remove the battery from its hook-and-loop base.





## NTSC Video-Out Card (6500)

Before you begin, remove the following:

- Logic board
- Video card
- PCI adapter
- PCI covers

- 1 Pull out the card that is plugged into the monitor-out slot.
- 2 Remove the two screws that secure the card to the logic board fence.

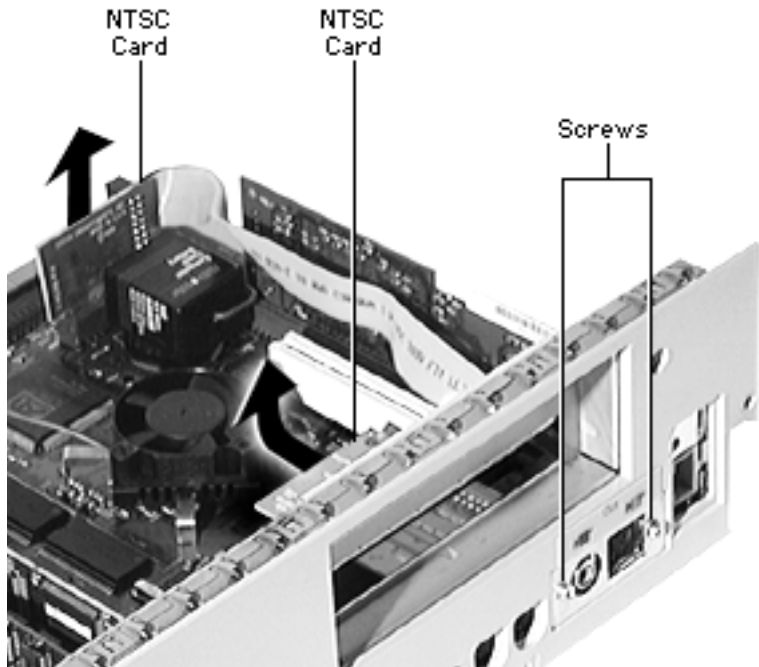



- 3 Pull the card away from the logic board fence to remove it from the logic board.

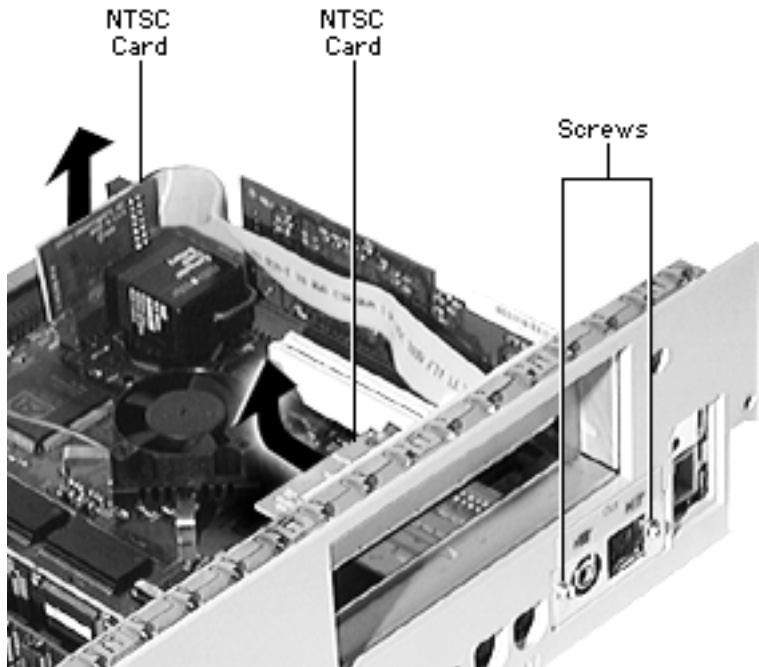



## Power Supply

Before you begin, remove the following:

- Front bezel
- Expansion bay cover
- Top cover
- Left panel
- Left metal panel

**Note:** If you look at the back of the computer, the power supply is located on the right.

**Caution:** Review the ESD precautions in Bulletins/ Safety.



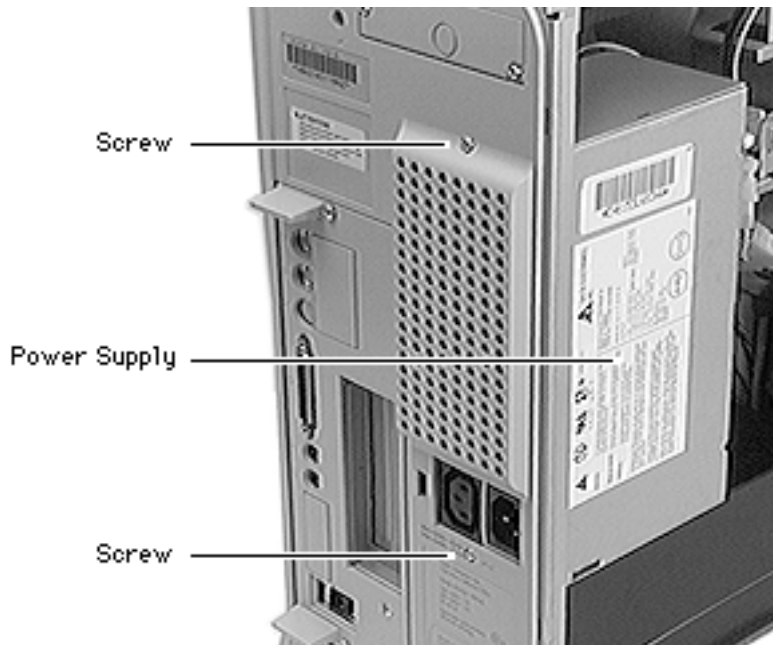

- 1 Remove the two screws that secure the power supply to the back of the computer.





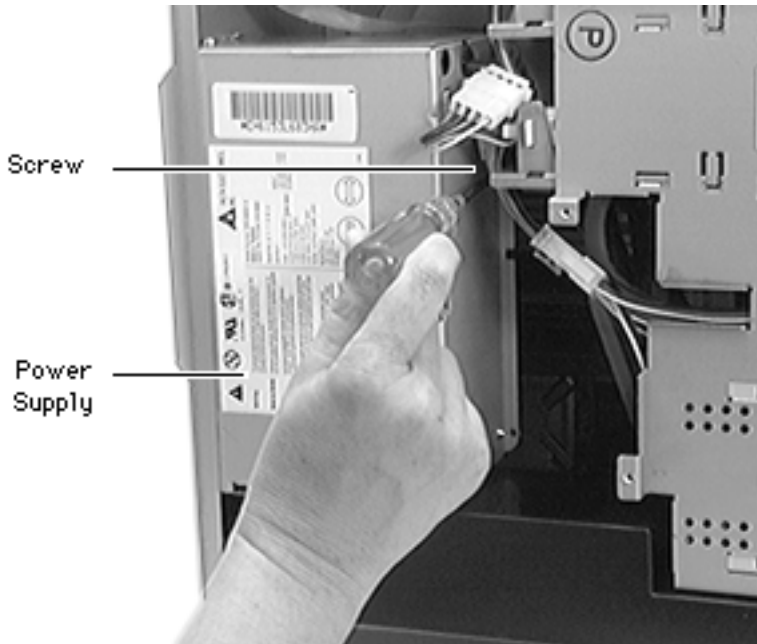

- 2 Lay the right side of the computer on a clean, smooth surface. (The power supply should be to your left and the drive bays to your right.)
- 3 Remove the screw that secures the power supply inside the computer.



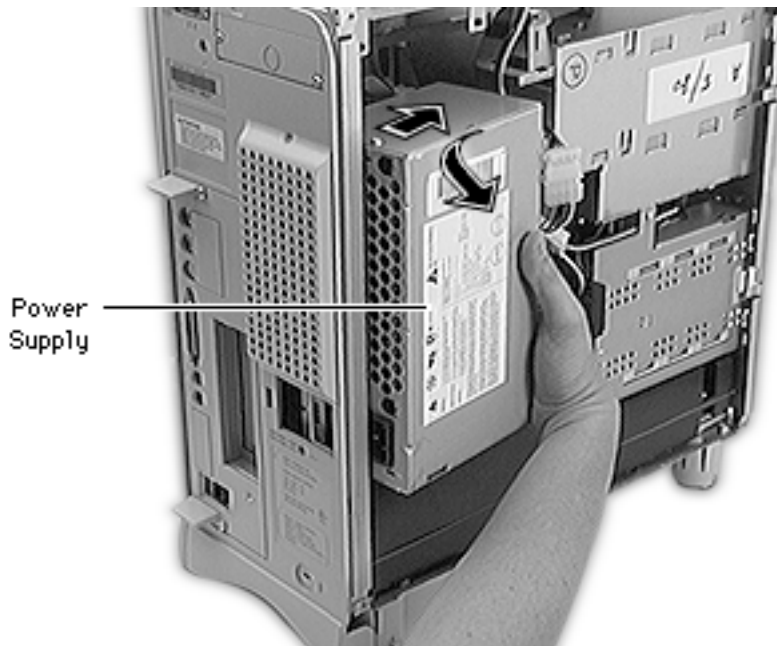

- 4 Set the computer upright again. Pull the power supply away from the rear of the chassis, and twist the left side out to remove it from the computer.



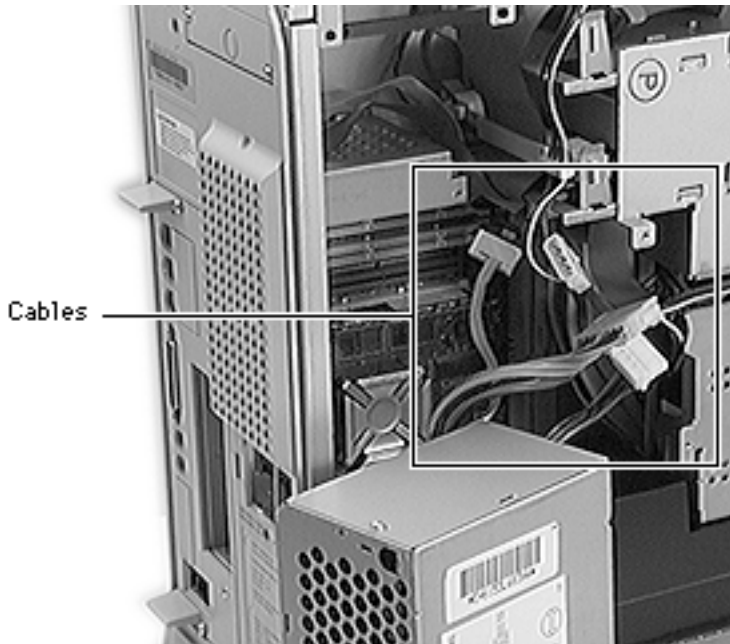

- 5 Disconnect the three cables attached to the power supply.

**Replacement Note:**

Before replacing the power supply, check the voltage switch. Make sure it's in the correct position for the voltage in your region. Failing to have the correct voltage setting could damage the power supply.





## Subwoofer/ Speaker Assembly

Before you begin, remove the following:

- Front bezel
- Expansion bay cover
- Top cover
- Left panel
- Left metal panel

**Note:** The subwoofer/speaker assembly is in the bottom of the chassis.

**Caution:** Review the ESD precautions in Bulletins/Safety.



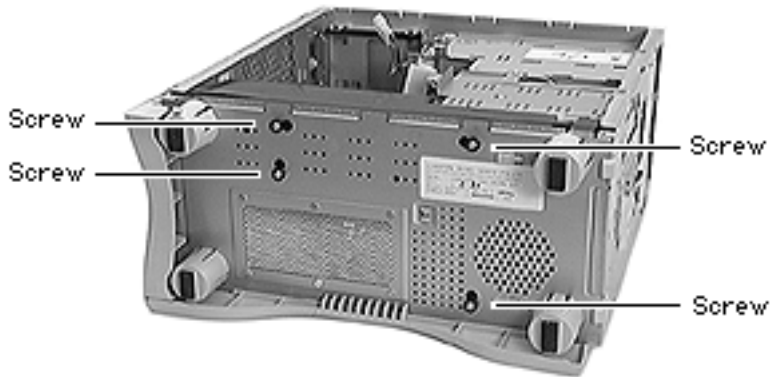

- 1 Lay the right side of the computer on a clean, smooth surface.
- 2 Using a T10 torx screw driver, remove the screws that secure the subwoofer/speaker assembly to the bottom of the chassis.



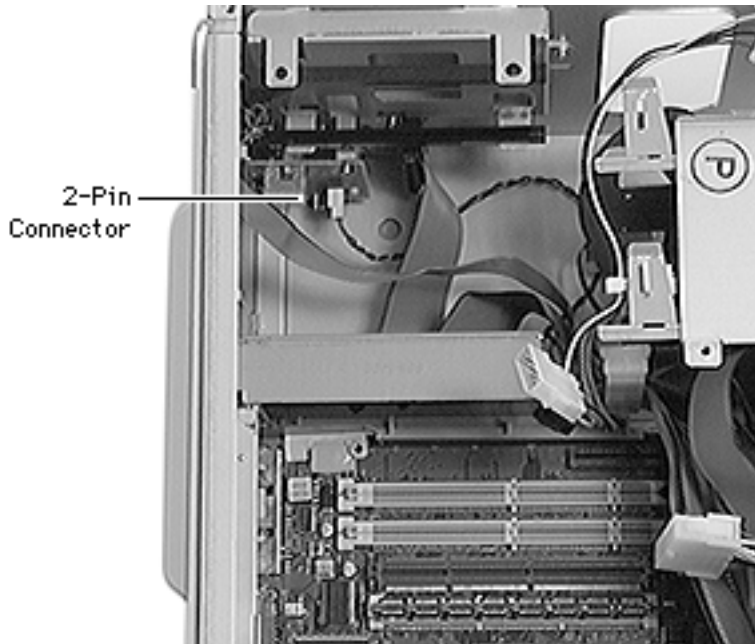

- 3 Pull the 2-pin connector from the audio/monitor connection subassembly in the upper rear corner inside the chassis.





- 4 Pull the subwoofer/speaker assembly out of the computer.

**Caution:** Don't attempt to open the subwoofer/speaker assembly. It is one service part.

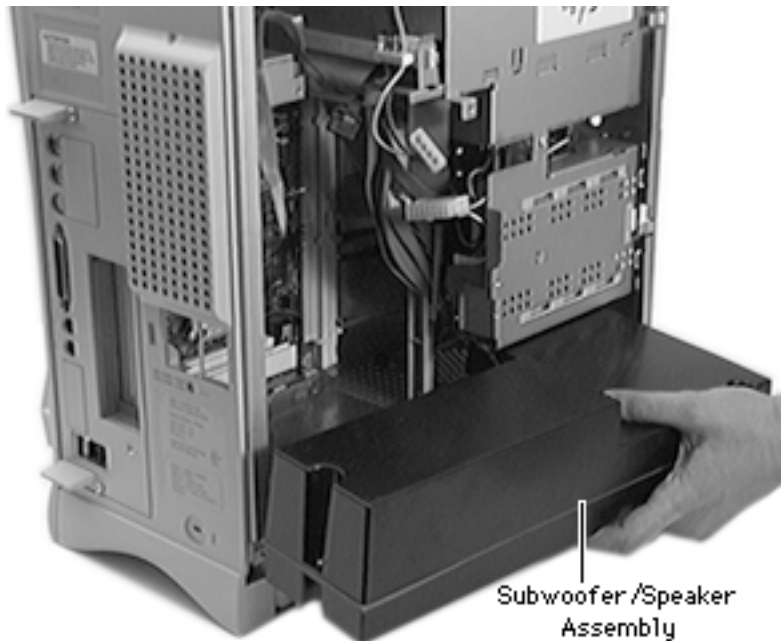



Plastic Tabs

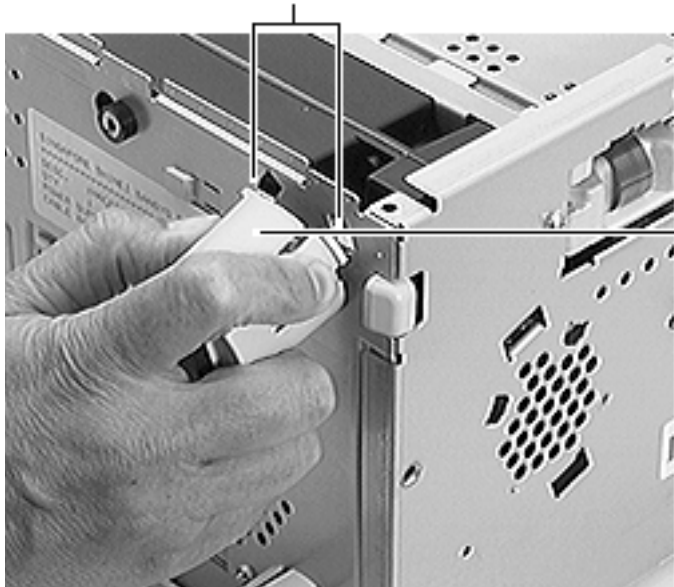

Foot

## Feet

Before you begin, remove the following:

- Front bezel
- Expansion bay cover
- Top cover
- Left or right panel

**Caution:** Review the ESD precautions in Bulletins/ Safety.

- 1 Place the right or left side of the computer on a clean, smooth surface.





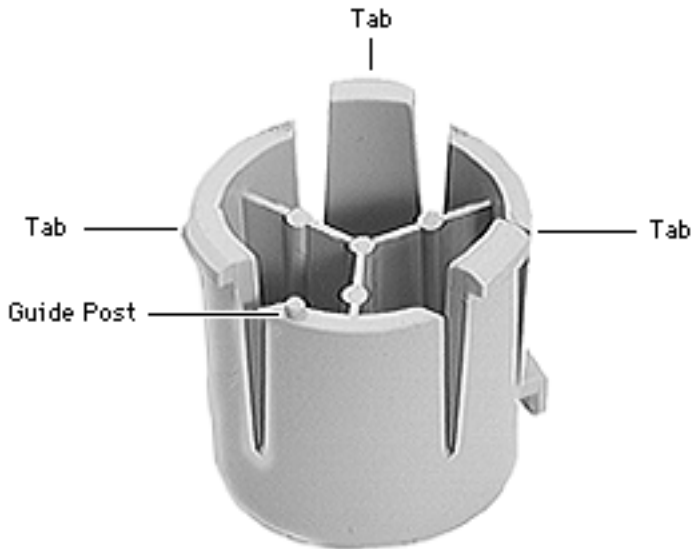

- 2 Press in two of the plastic tabs on a foot.
- 3 Tilt the foot toward the third plastic tab to clear the slots and remove the foot.

**Replacement Note:** There is a raised plastic guide post that fits in a notch on the bottom of the computer. Be sure to line up the guide post with the notch.





## TV/FM Tuner Card

**Caution:** Review the ESD precautions in Bulletins/ Safety.

- 1 Remove the two screws from the TV/FM tuner card cover.

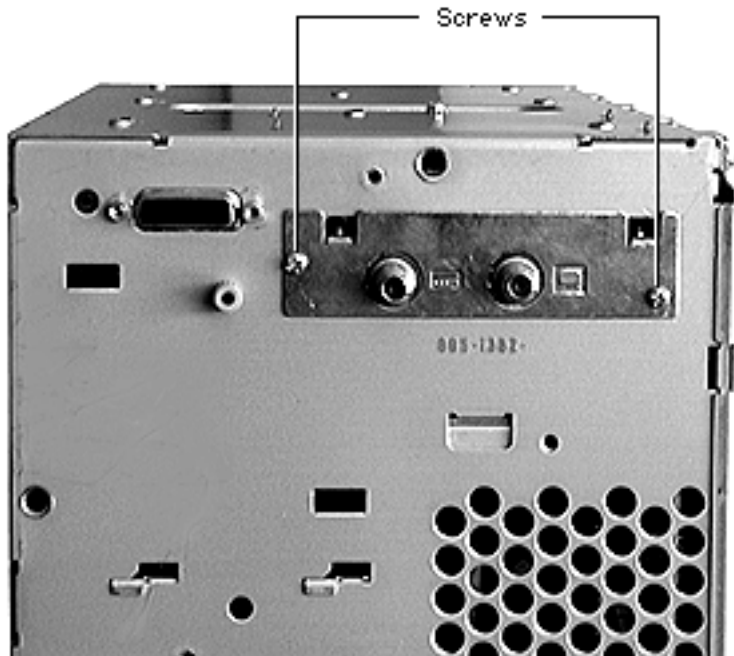



TV /FM Tuner Card



- 2 Pull the TV/FM tuner card from the computer.





Ribbon  
Cable

- 3 Turn the card over and disconnect the ribbon cable from the card.





Audio/Monitor  
Connection  
Subassembly



## Audio/Monitor Connection Subassembly

Before you begin, remove the following:

- Front bezel
- Expansion bay cover
- Top cover
- Left panel
- Left metal panel
- TV/FM Tuner (if present)

**Caution:** Review the ESD precautions in Bulletins/ Safety.



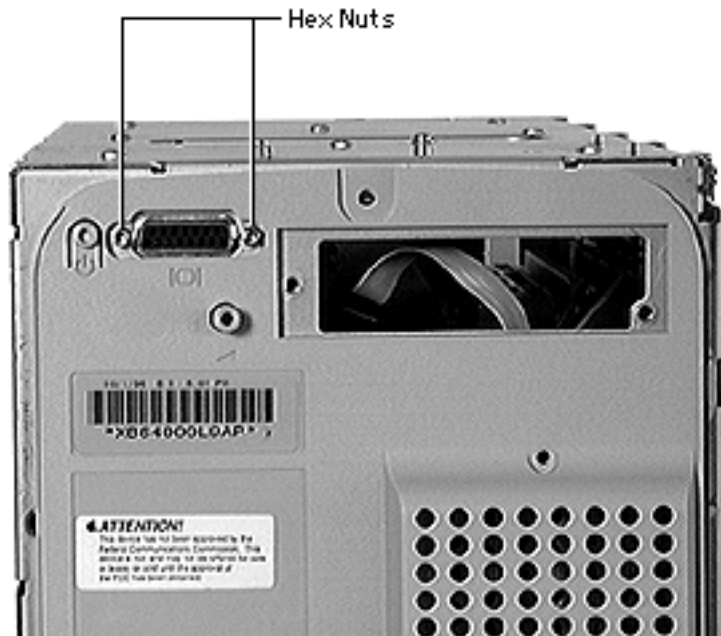

- 1 Using a hex nut screw driver, remove the two hex nuts on either side of the monitor-out port.



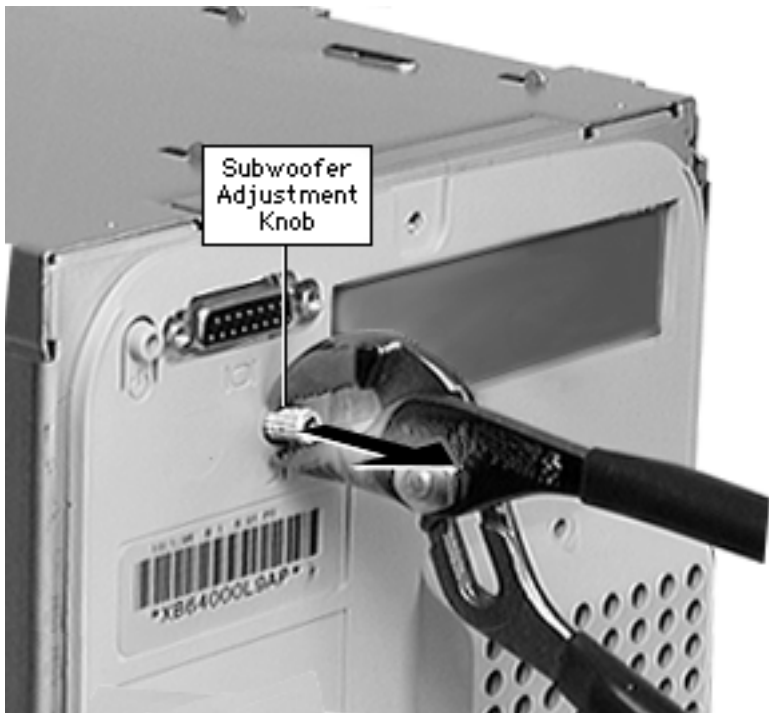

- 2 Remove the subwoofer adjustment knob by grasping it firmly with a pair of pliers and pulling straight out.



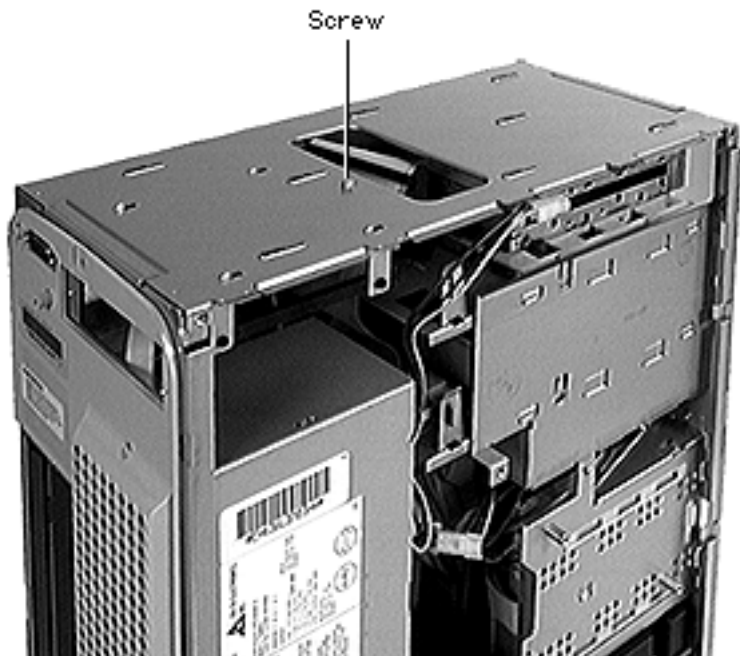

Screw

- 3 Remove the screw that secures the subassembly to the top of the chassis.





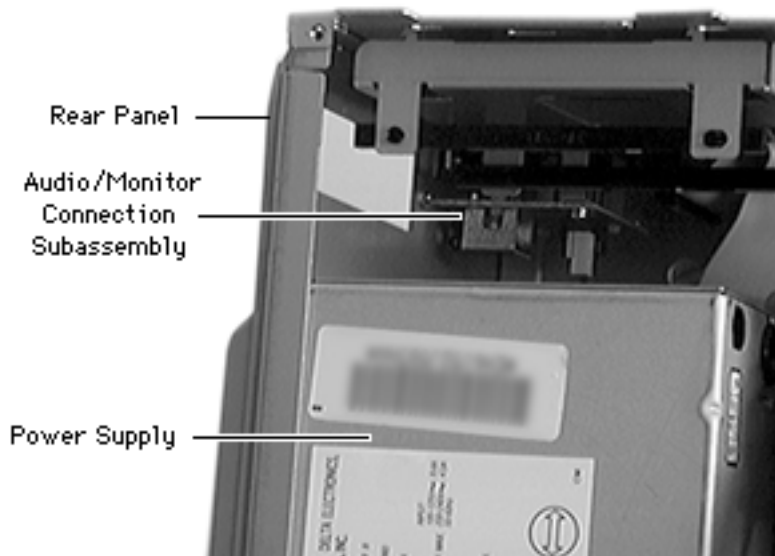

- 4 Reach through the left side of the computer and carefully pull the audio/monitor connection subassembly away from the rear of the computer.





- 5 Disconnect the 2-pin connector and the ribbon cable from the subassembly boards.

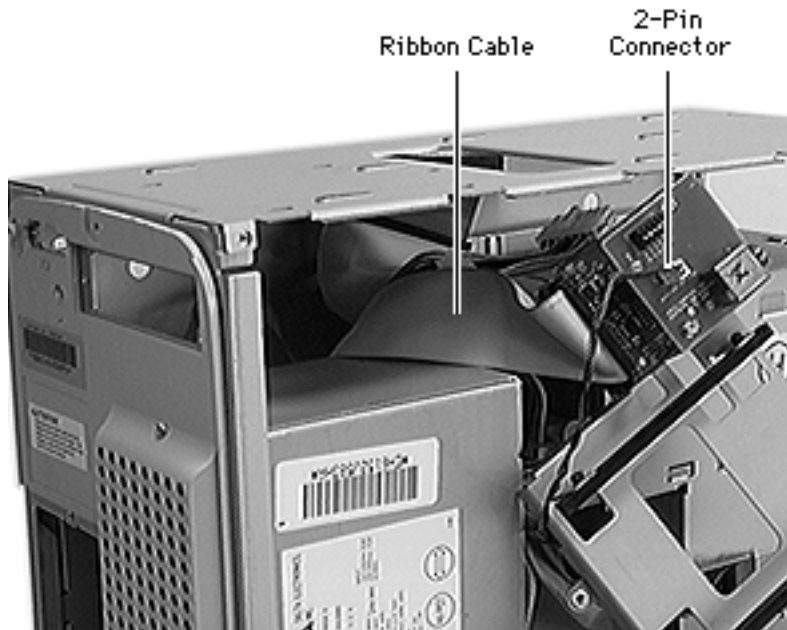



## Upgrades

---

Performa/Power Macintosh  
6400 and 6500 Series





## TV/FM Tuner Card

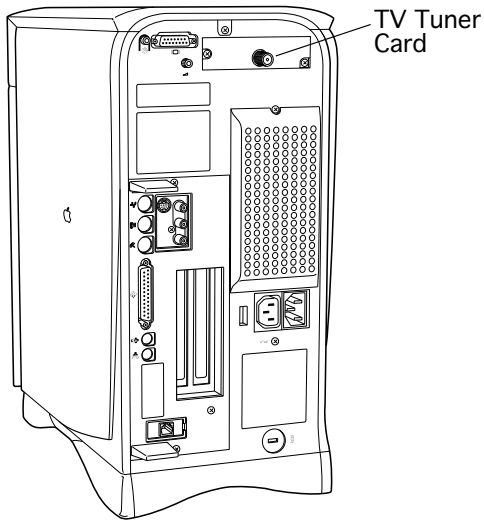

**Note:** The TV/FM tuner card is an option.

**Caution:** Review the ESD precautions in Bulletins/Safety.



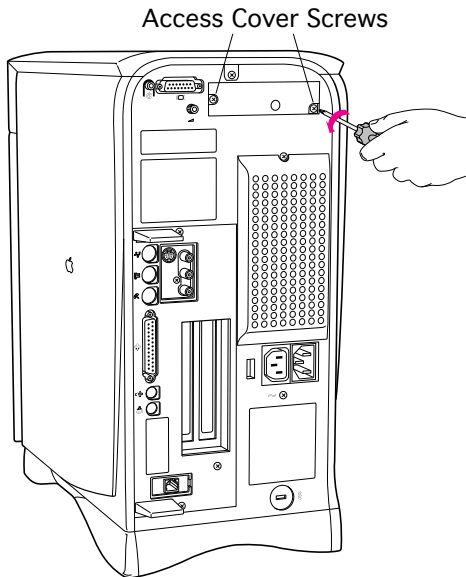

- 1 Remove the two screws from the TV tuner card access port cover.
- 2 Remove the TV tuner card access port cover from the computer.





- 3 Pull the TV tuner card ribbon cable a short way out of the access port.

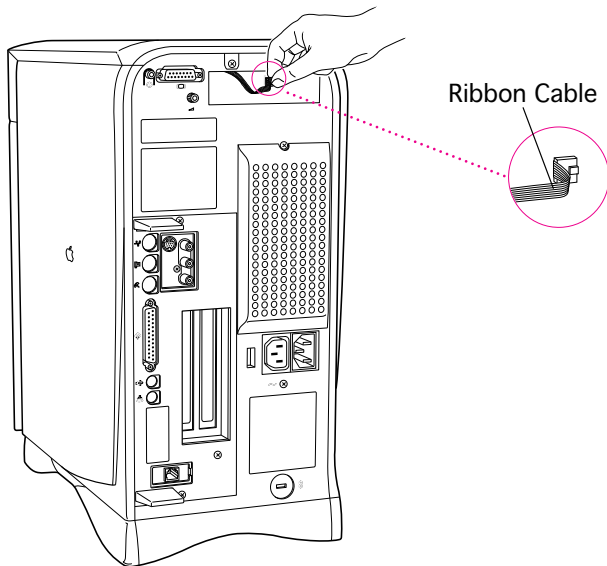



- 4 Connect the ribbon cable plug to the TV/FM tuner card connector.

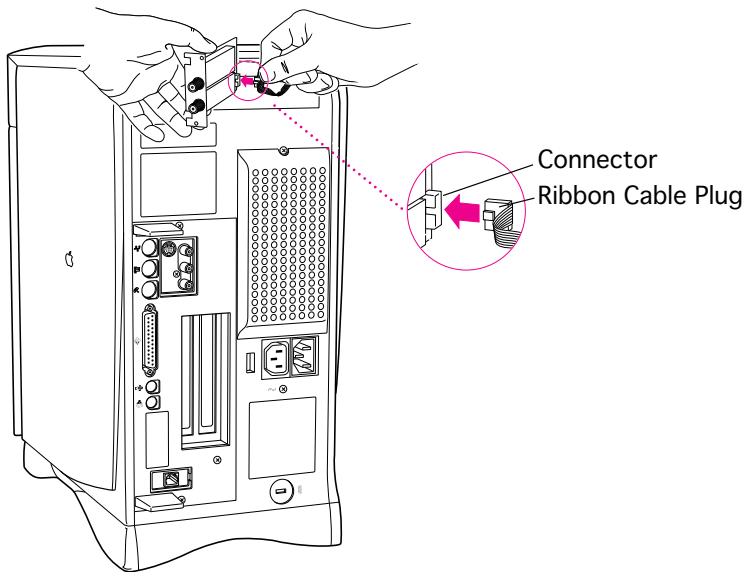

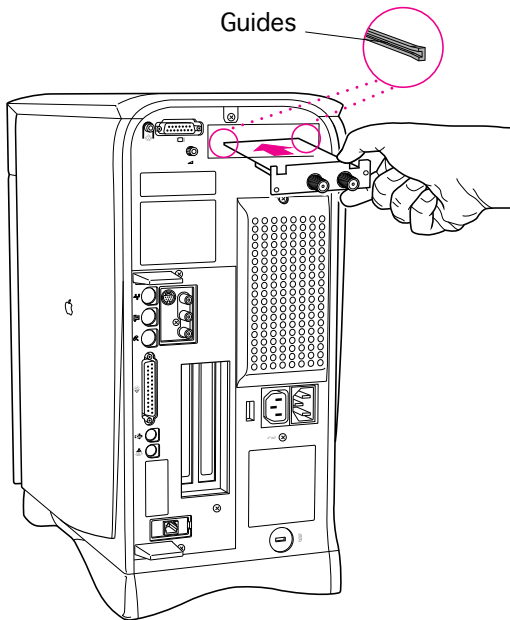

- 5 Slide the TV/FM tuner card into place along the guides on both sides of the access port.







- 6 Replace the two screws that hold the TV/FM tuner card in place.

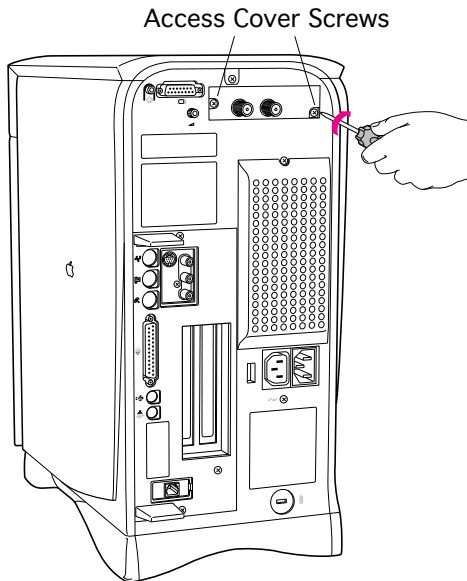



## DRAM DIMM Upgrade

Before you begin, remove the logic board.

**Caution:** Review the ESD precautions in Bulletins/ Safety.

**Note:** Before servicing a 6400, read the “EDO-Compatible Logic Board Identification” topic at the end of this section.





- 1 Push the ejector on the DRAM slot outward and down to open it.

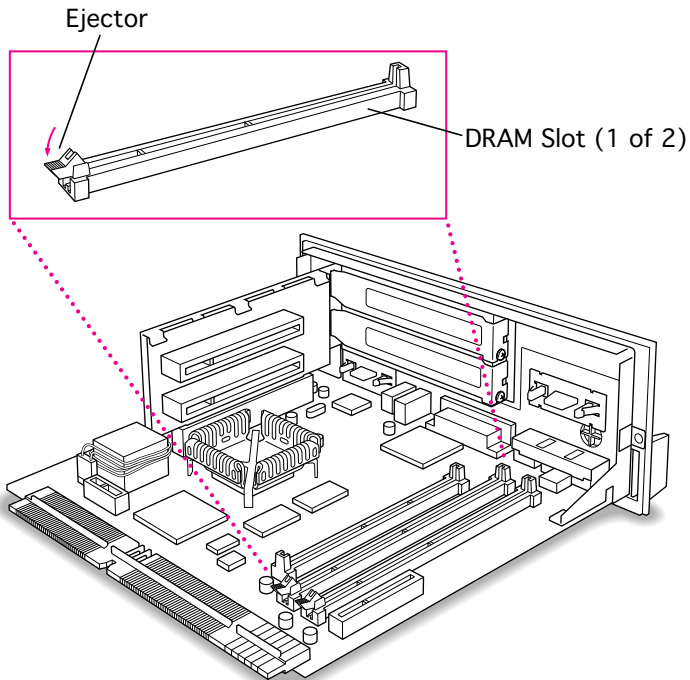

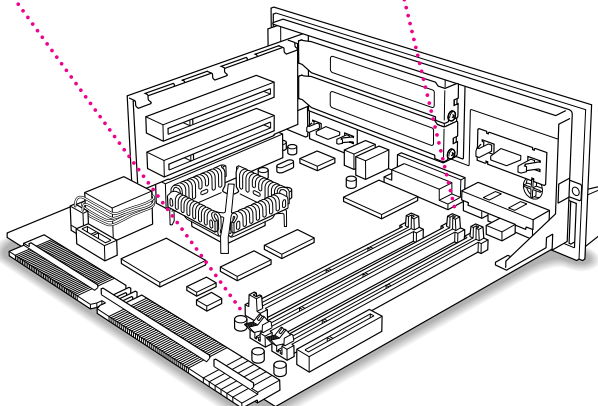
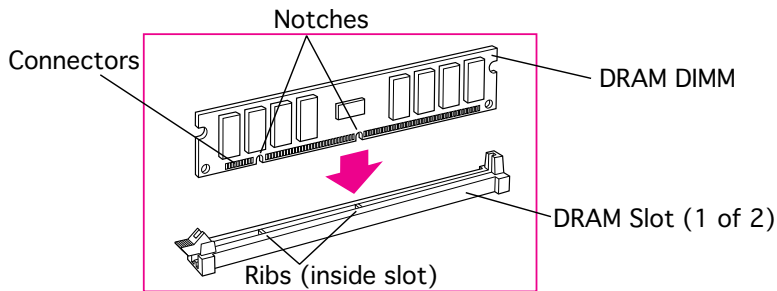

- 2 **Note:** The DRAM DIMM is designed to fit into the slot only one way.

With the ejector still pushed outward and down, position the DIMM with its notches aligned with the small ribs inside the slot.

- 3 Push down on the DIMM until it snaps into place and the ejector closes automatically.





## EDO-Compatible Logic Board Identification

Before you install extended data out (EDO) memory in a Performa or Power Macintosh 6400 computer, you must verify that the logic board is EDO-compatible.

There are four ways to verify that a logic board from a Performa or Power Macintosh 6400 computer is compatible with EDO memory:

- The logic board is the original board that shipped in a Macintosh Performa 6400 equipped with an internal Zip drive
- The logic board has soldered-on EDO DRAM
- The logic board has a resistor present at chip U34
- The logic board has **no** resistor present at location R77

The details for identifying an EDO-compatible logic board by these methods are presented in the following sections.





## Performa 6400 with Zip Drive

If a Macintosh Performa 6400 included an internal Iomega Zip drive, the logic board shipped in the computer supports EDO memory.

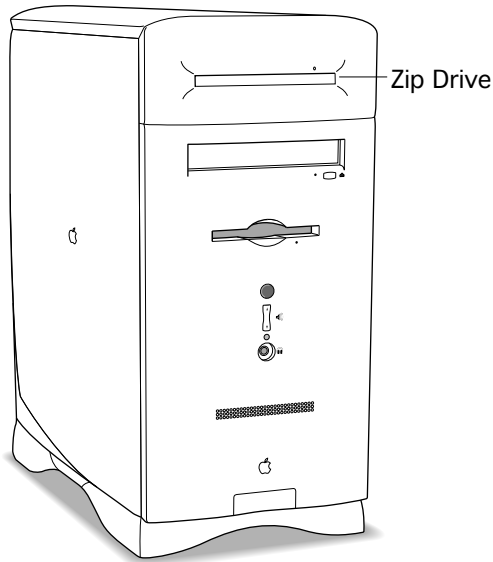



## Soldered-On DRAM is EDO

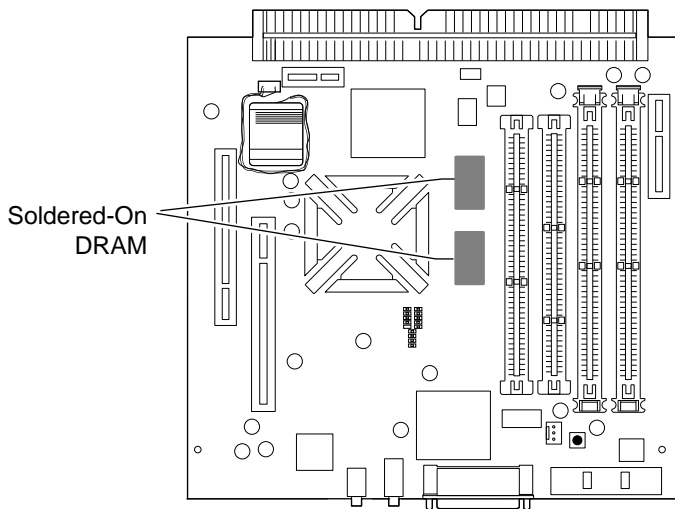

- 1 Locate the two soldered-on DRAM chips.
- 2 Compare the markings on these chips to the examples in the EDO Chip Identification table on the next page. If the soldered-on DRAM chip markings meet the criteria of an example here, the logic board supports EDO memory.





**Important:** Apple may use vendors not listed on this table. If the DRAM markings don't match the table criteria, use another identification method.

### EDO Chip Identification

Vendor	Marking Example
SEC	The third character from the right is a non-zero number (for example, KM44C400 <b>4</b> -60)
SEC	The fourth character from the right is a non-zero number (for example, KM416C120 <b>4</b> BJ-6)
Hyundai	The second character from the right is a non-zero number (for example, HY51181 <b>64</b> B)
Micron	A space and a capital X are present at the end of the marking (for example, MT8D264G-xx <b>X</b> )





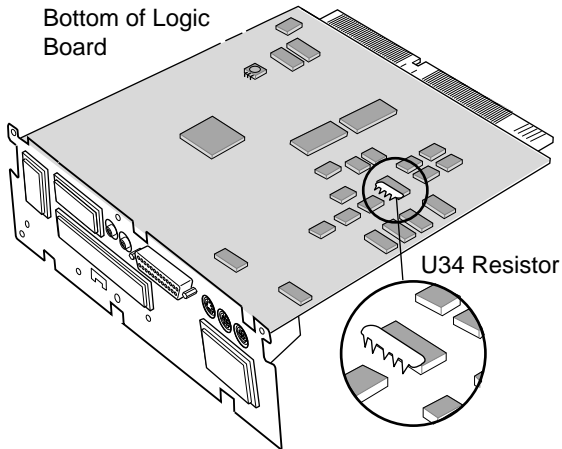

## Resistor Present at U34

- 1 Turn the logic board over so that you are looking at the soldered-side of the board.
- 2 Locate chip U34 as pictured in the graphic. If a resistor package (SIP network) is on top of the U34 chip, as seen in this picture, the logic board supports EDO memory.



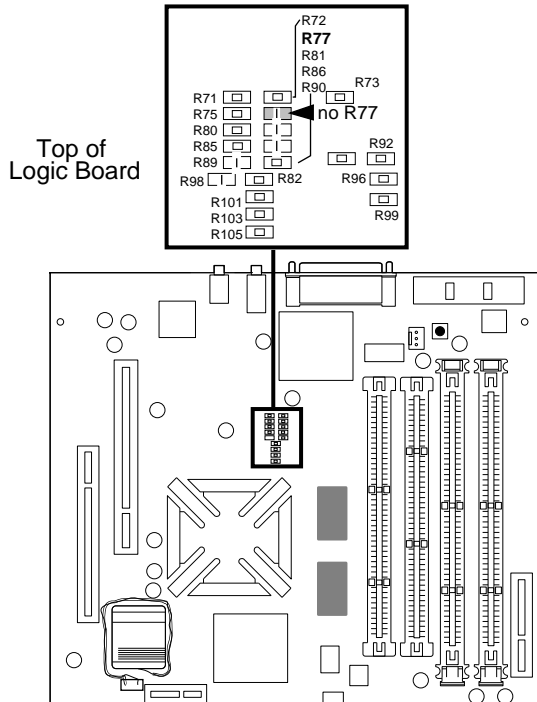

## No Resistor at R77

- 1 Use the graphic here to locate the R77 resistor space near the SCSI port on the logic board.
- 2 If a resistor does not occupy the R77 location, as seen in the picture, the logic board supports EDO memory.





# Communications Card

Before you begin, remove the logic board.

**Caution:** Review the ESD precautions in Bulletins/ Safety.

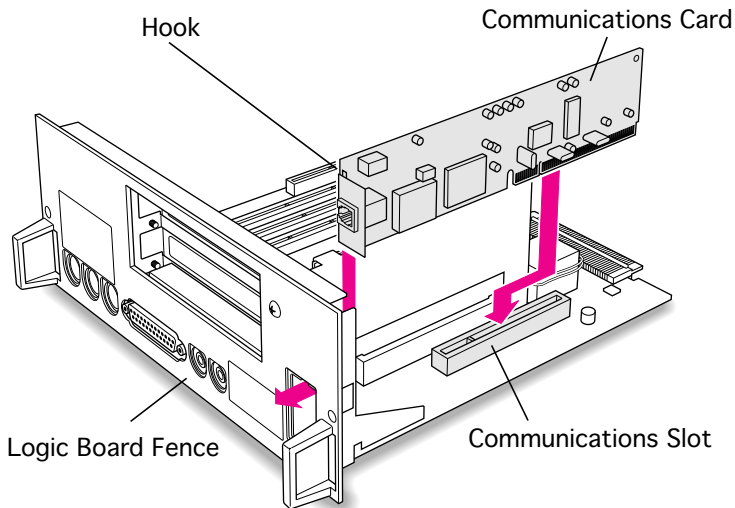

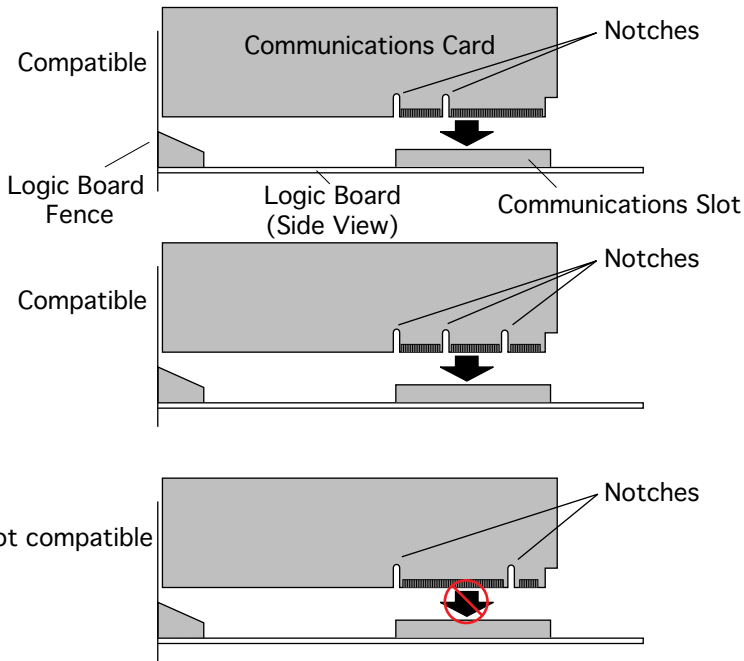

**Note:** Some communications cards are not compatible. Look at the placement of the notches on the card, and use this illustration to help identify a compatible card.



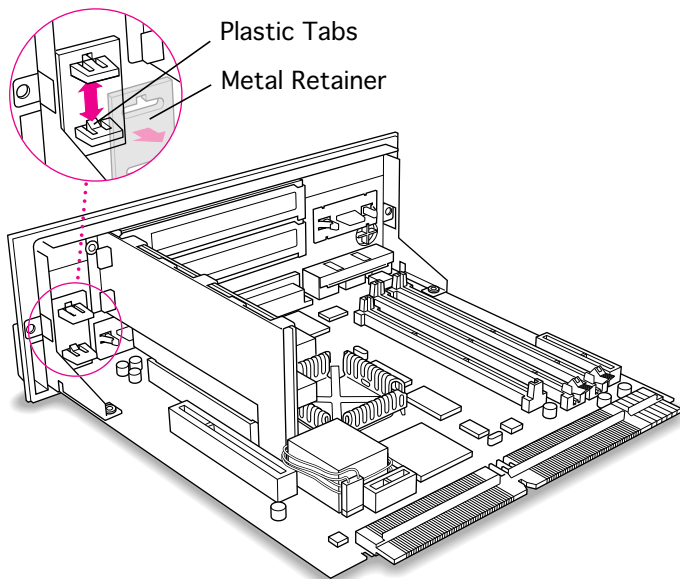

- 1 Remove the communications card access port cover by pushing the two plastic tabs apart and removing the metal retainer.



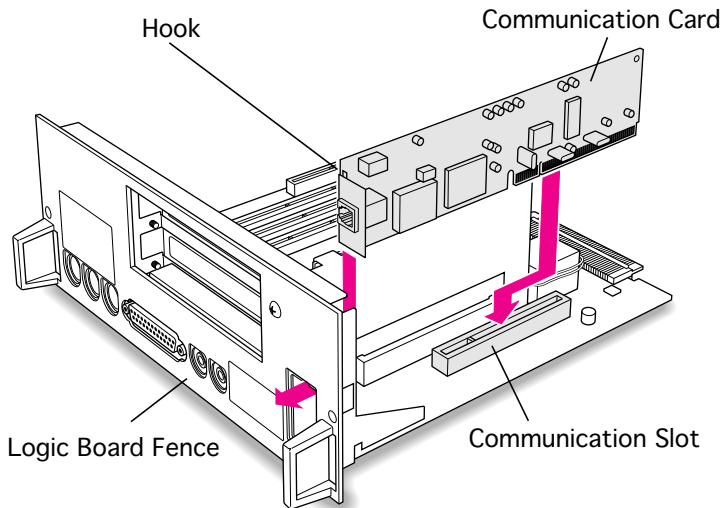

- 2 Align the card over the communications slot.
- 3 Check the external connector on your card to see if it has a hook.

If the communications card has a hook, be sure the hook engages the metal on the inside of the logic board fence. Push down on the back end of the card until it is firmly seated in the slot.



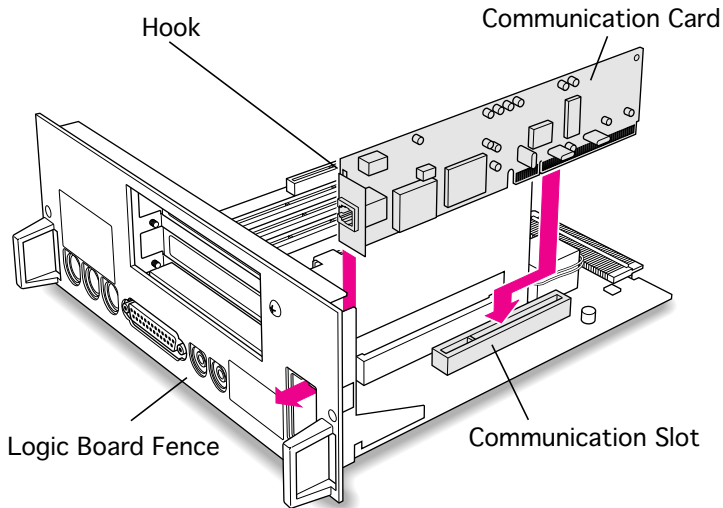

If the card does not have a hook, pass the external connector through the hole in the logic board fence, and insert the card into the communications slot. Press down on the card until the connector is solidly in place.

- 4 Lift gently on the card to test the connection. If the card resists and stays in place, it's connected.



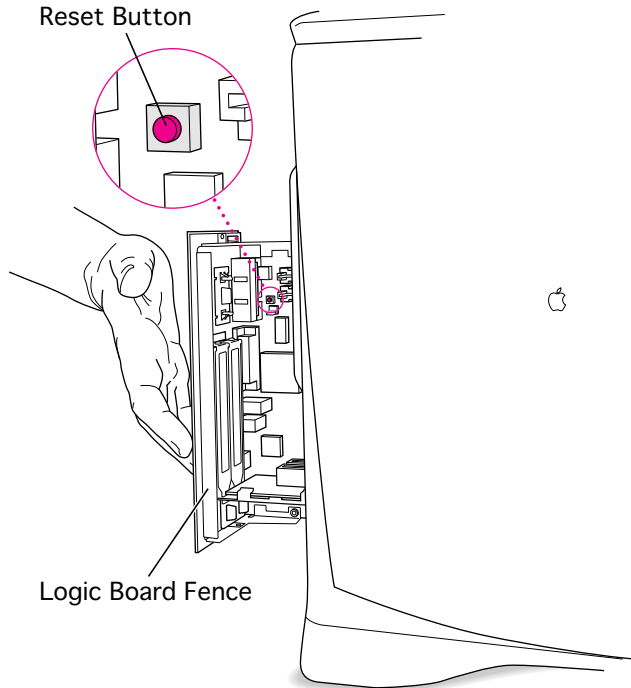

- 5 Press the reset button on the logic board.
- 6 Reinsert the logic board into the computer.

**Note:** The communications card may require software installation. An Ethernet card may need the network connection changed in the AppleTalk control panel.







## PCI Card

Before you begin, remove the logic board.

**Note:** If you are installing a PC compatibility card, see the instructions in the Upgrades chapter of the PC Compatibility Card manual under the Cards topic.

**Caution:** Review the ESD precautions in Bulletins/ Safety.

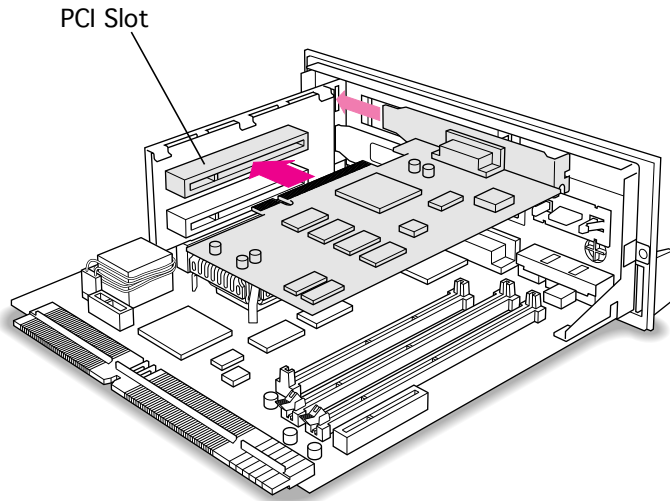

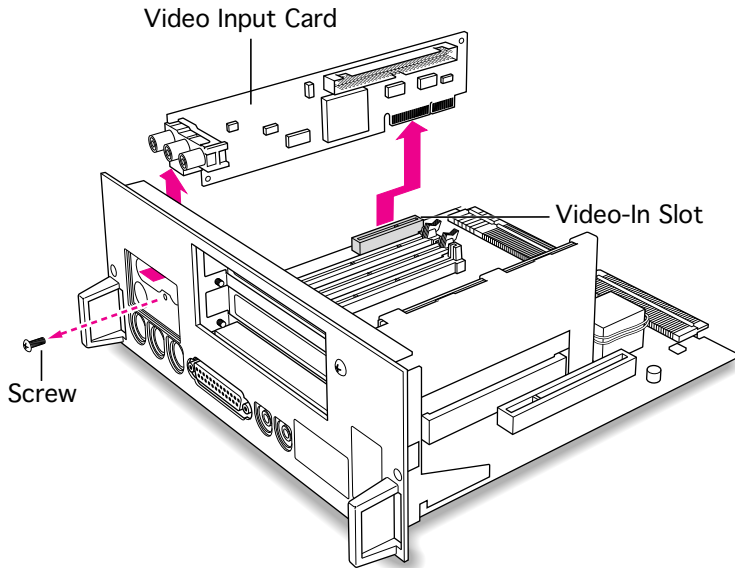

- 1 **Note:** If you are going to install a PCI card in the lower PCI slot, and a video input card is installed, you must temporarily remove the video input card.

Remove the screw on the front of the vertical plate and remove the video card.



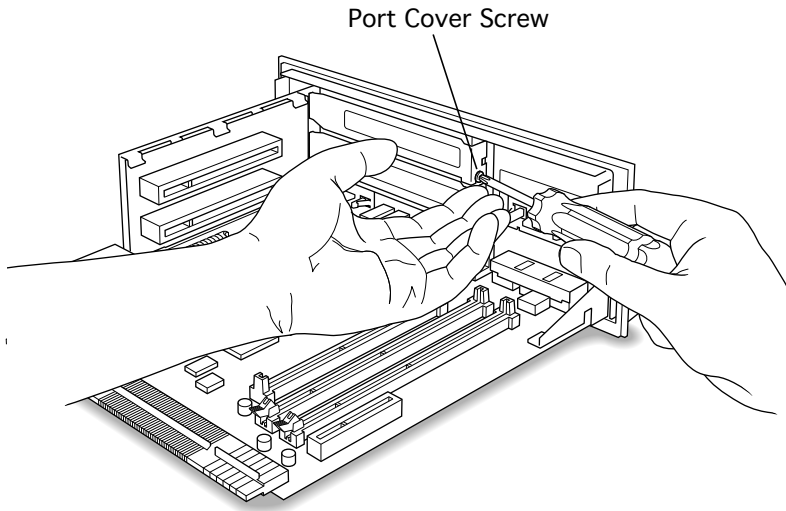

- Note:** Place one hand under the screw and PCI card access cover to catch them when they come loose and thus avoid dropping them into the logic board.

Remove the screw that holds the access port cover in place.





- 3 Remove the access port cover.

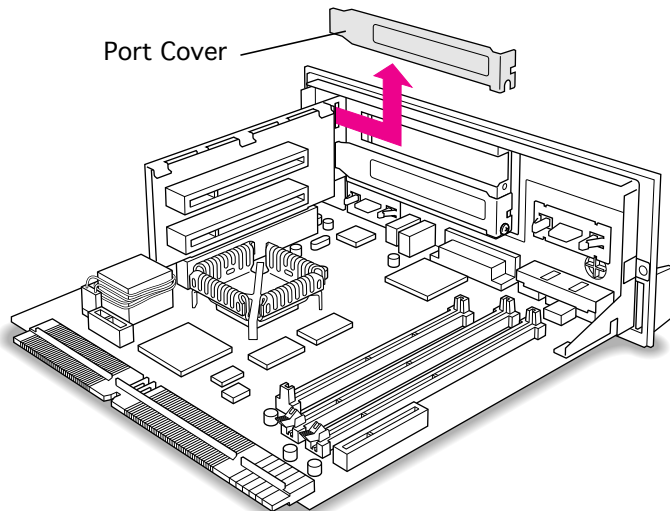



- 4 Hold the card by its edges to avoid touching any connectors.

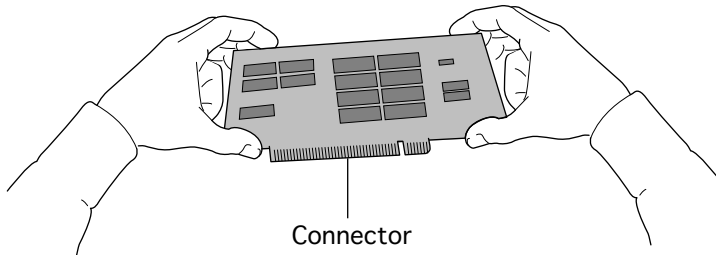

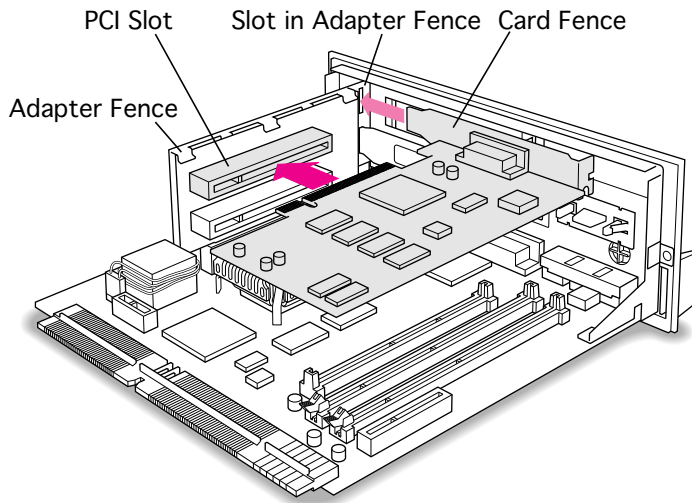

- 5 Place the card into the PCI slot, matching the metal fence on the card to the open port.





- 6 Support the adapter fence with one hand, and push on the card until it snaps into place.

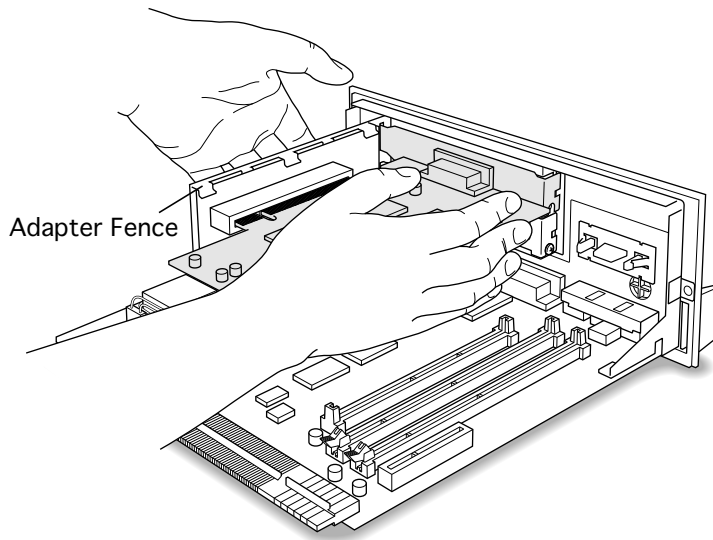



- 7 Replace the screw to hold the PCI card fence in place.

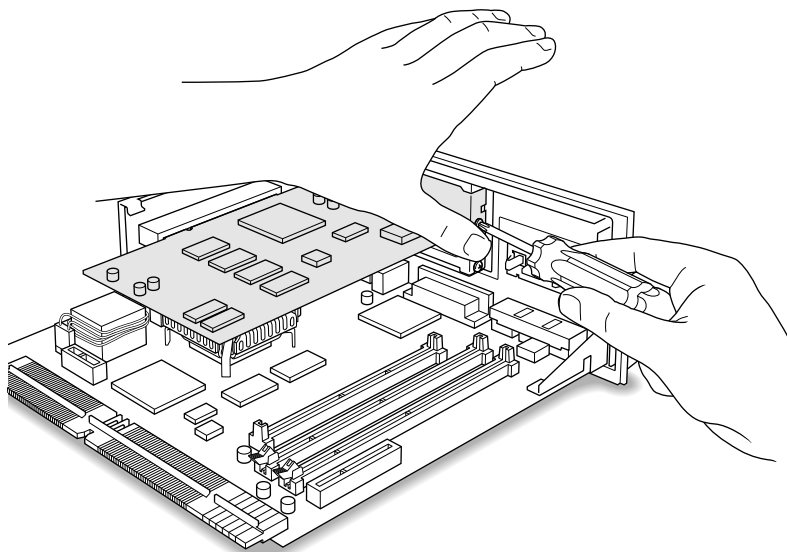





- 8 If you removed a video input card, replace it.

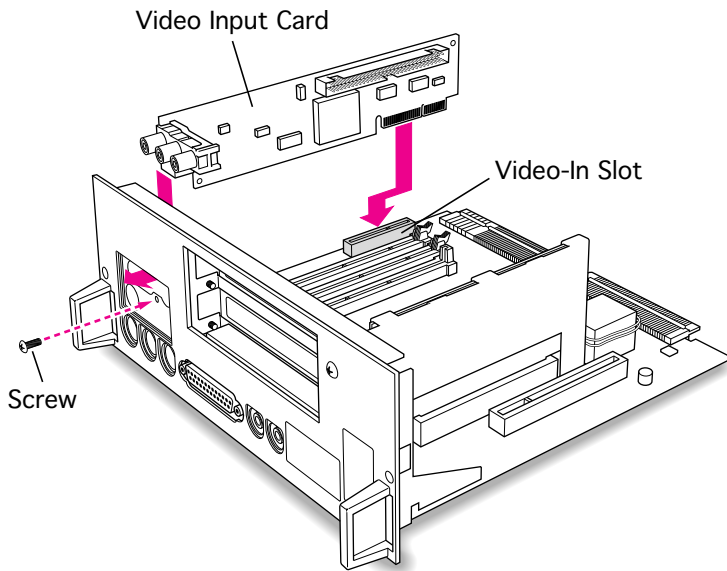



## Avid Cinema Card

Before you begin, remove the logic board.

**Caution:** Review the ESD precautions in Bulletins/ Safety.

- 1 Follow the steps in the PCI Card section of this chapter, choosing to place the card in the top or bottom PCI expansion slot on the PCI adapter card.

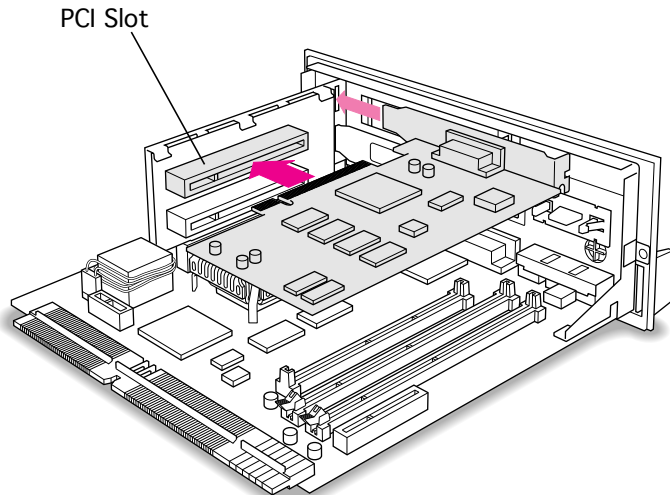



- 2 If a video input card has not been installed, install one now.

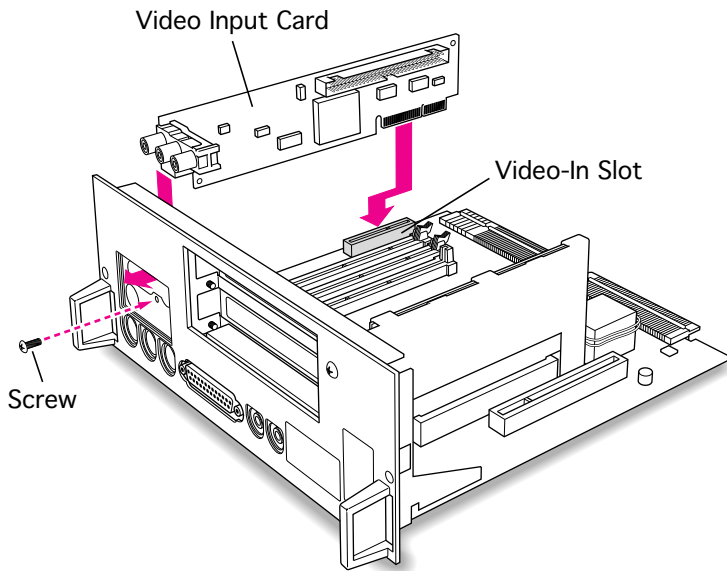



## Connect the Avid Cinema Card to the Video Input Card

**Note:** Use the shorter (2.5") DAV ribbon cable. The two ends of the cable are identical. Match the notches on the card connectors to install the cable correctly.

- 1 Hold one hand beneath the Avid Cinema card to support the card.
- 2 Align the tab on the cable's connector with the notch in the card's connector.

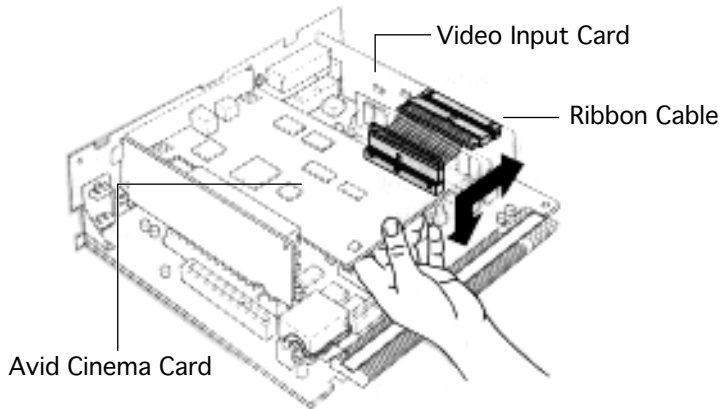

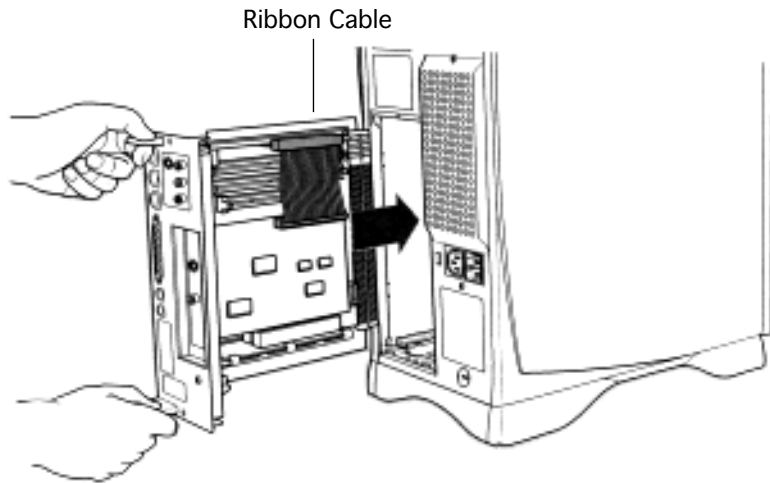

- 3 Press firmly to connect the correct end of the ribbon cable to the Avid Cinema card.
- 4 Connect the other end of the ribbon cable to the video input card in the same way.
- 5 Carefully replace the logic board to avoid catching the ribbon cable.





## High Performance Module (Cache)

Before you begin, remove the logic board.

**Caution:** Review the ESD precautions in Bulletins/ Safety.

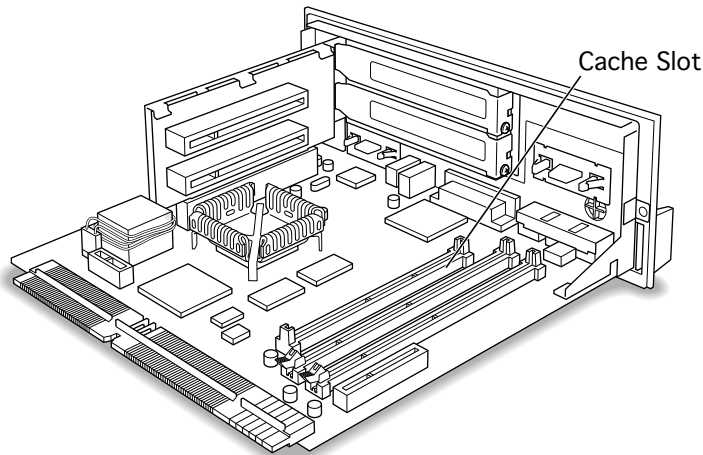

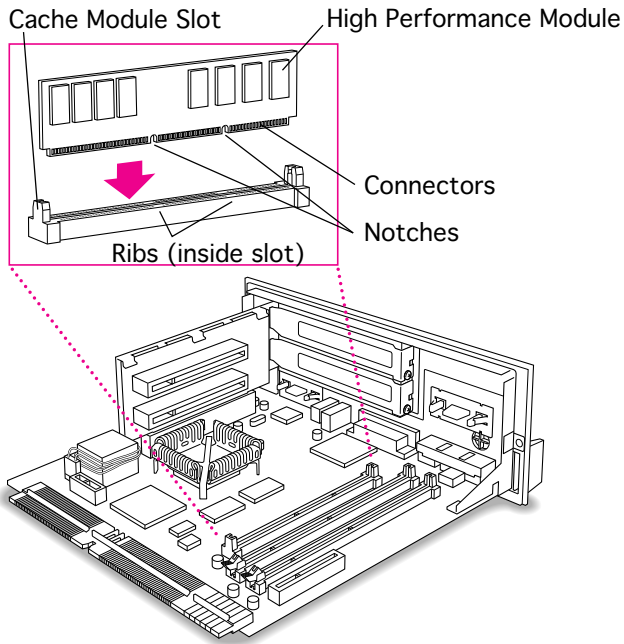

**Note:** The module is designed to fit into the slot only one way.

Align the notches in the module with the small ribs inside the slot, and snap the card into place on the logic board.





## Additional Procedures

---

Performa/Power Macintosh  
6400 and 6500 Series







## Battery Verification

Before you begin, remove the logic board.

**Caution:** Review the ESD precautions in Bulletins/ Safety.

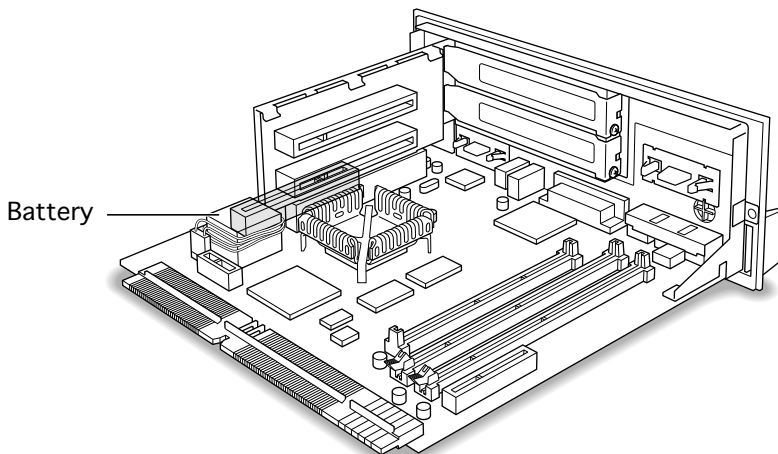

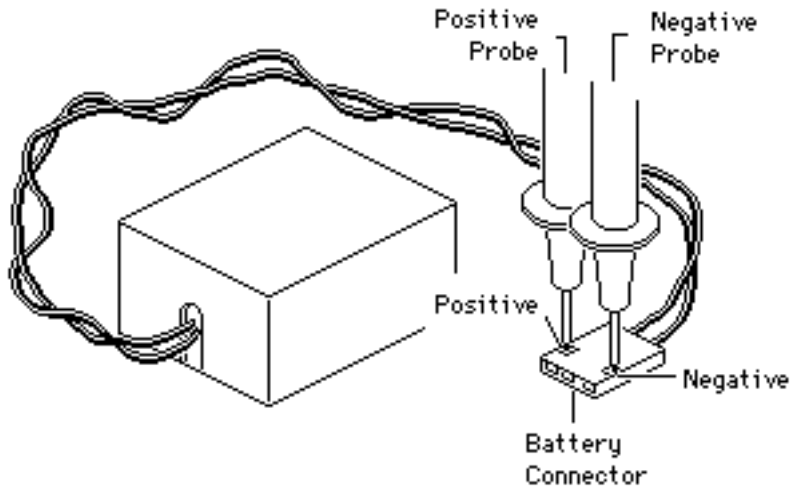

- 1 Set the voltmeter to the 10 volts DC scale.
- 2 Hold the positive probe of the voltmeter to the positive end of the battery and the negative probe to the negative end of the battery.
- 3 If the battery voltage is below 3.0 volts, replace the battery. Refer to “Battery Replacement” in this chapter.





## Battery Replacement

Before you begin, remove the logic board.

**Caution:** Review the ESD precautions in Bulletins/Safety.

**Warning:** If handled or discarded improperly, the lithium battery in the computer could explode. Review battery handling and disposal instructions in Bulletins/Safety.

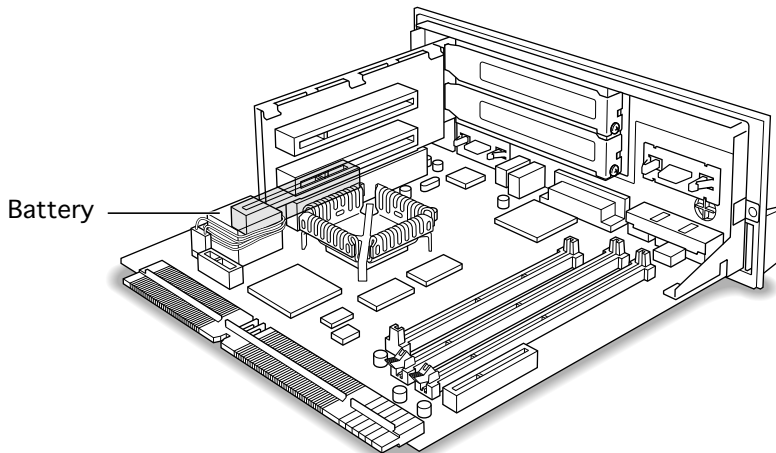

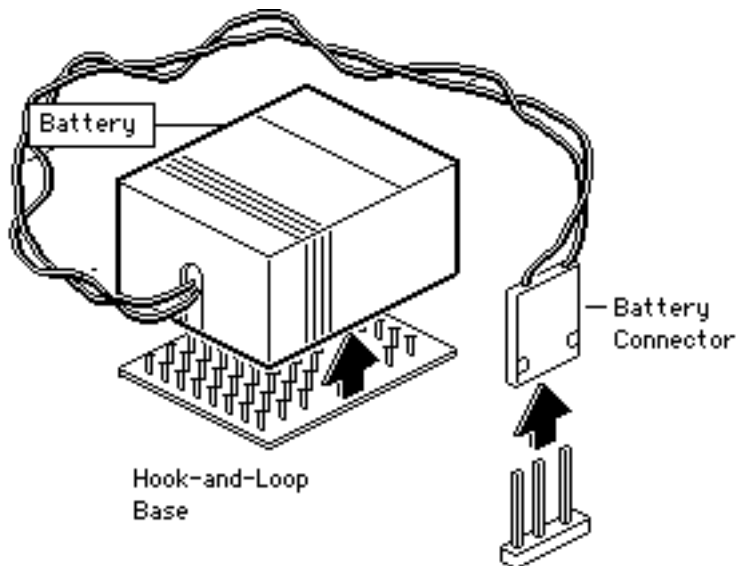

- 1 Pull up and disconnect the connector.
- 2 Pull up and remove the battery from its hook-and-loop base.





## Logic Board Reset

Before you begin, remove the logic board.

**Caution:** Review the ESD precautions in Bulletins/ Safety.

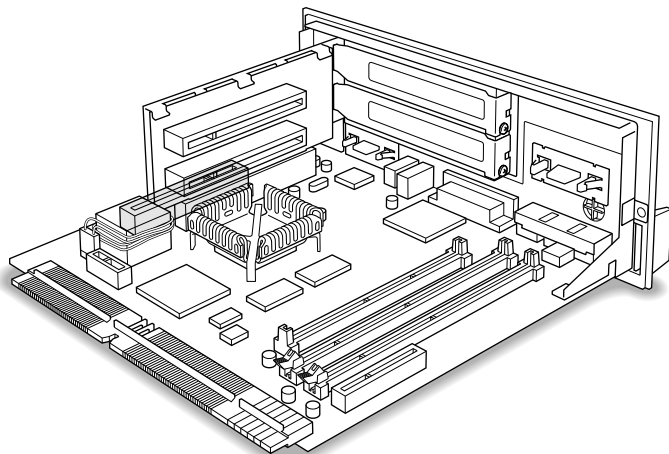

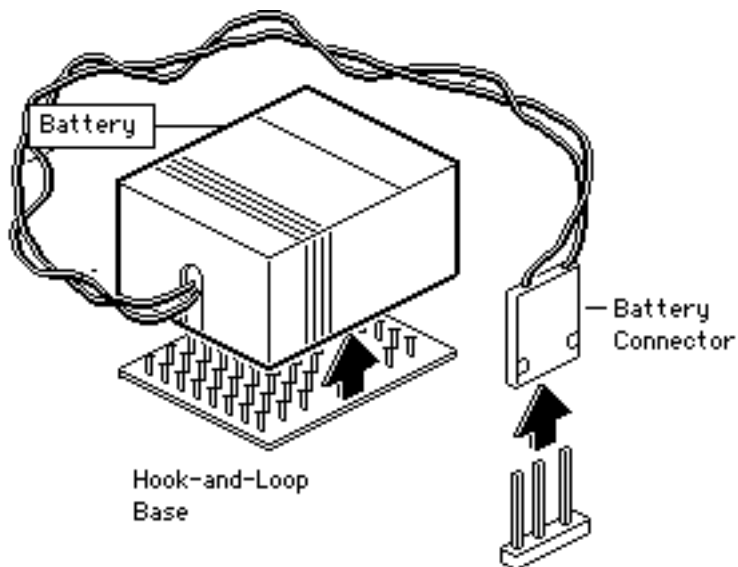

- 1 Pull up and disconnect the battery connector.
- 2 Pull up and remove the battery from its hook-and-loop base.
- 3 Wait 5-10 minutes and then replace the battery.



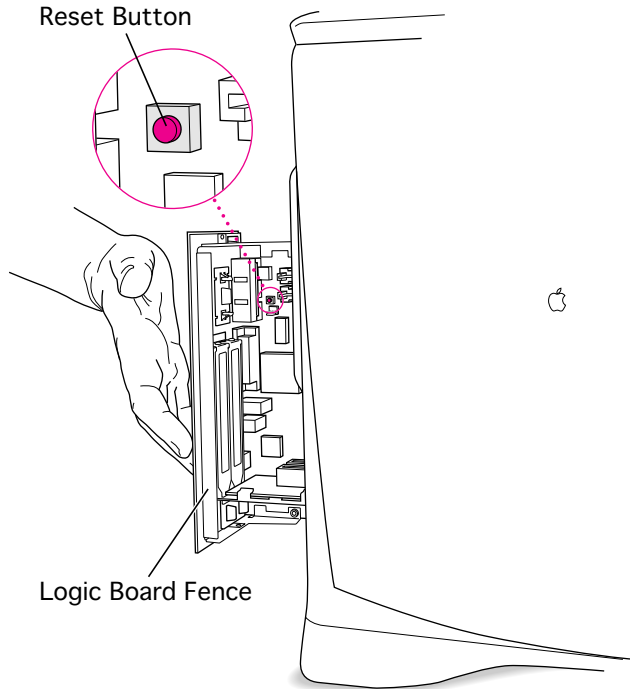

- 4 Press the reset switch on the logic board using a flat plastic tool.
- 5 Fully seat the logic board in the enclosure.





**Note:** This procedure resets PRAM. Be sure to check the computer's time/date and other system parameter settings following the procedure.

**Note:** If this procedure resolves the problem, claim an adjustment on an SRO. If not, replace defective component and **do not** claim the adjustment.







## 6500—Distinguishing Video Jitter from Blur

Service providers may encounter two slightly different video symptoms on monitors connected to Power Macintosh 6500 computers. The first step in troubleshooting this issue is to differentiate video jitter from blurry video. There is a different solution to each of these conditions.

Video jitter affects monitors connected to models having a 225 or 250 MHz logic board. Jitter is evident at the edges of the screen or windows and dialog boxes where the pixels shimmer or jump.

Blurry video is seen as a fuzzy image over the entire screen on monitors set to resolutions of 832 x 624 and higher.





Power Macintosh 6500 computers falling within the following serial number ranges may have these video issues.

Video Jitter:

PM 6500 from XB708xxxxx to XB718xxxxx

Blurry Video:

PM 6500 from XB708xxxxx to XB723xxxxx



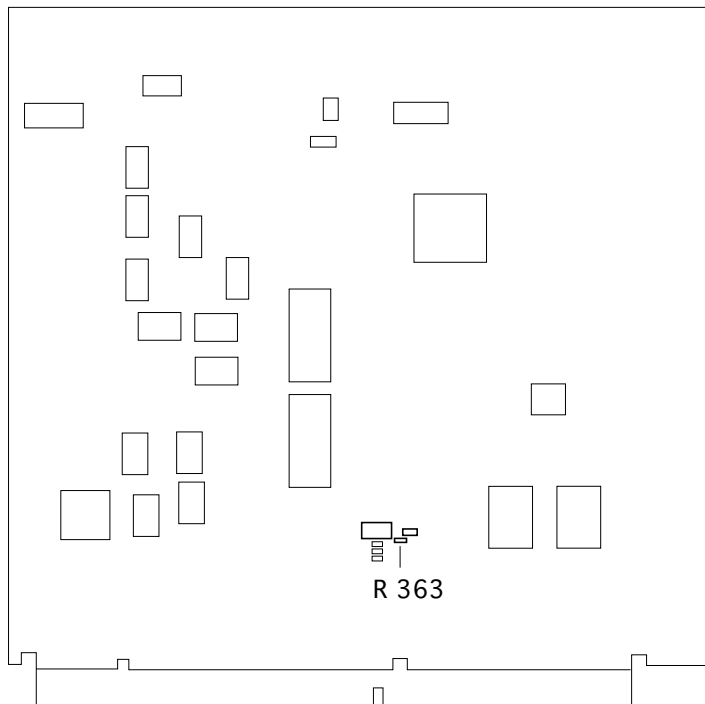

## Video Jitter Solution

If you identified a video jitter symptom, you need to inspect the logic board to distinguish a reworked board from a board that hasn't been reworked. Apple has reworked 225 MHz (P/N 661-1322) and 250 MHz (P/N 661-1332) logic boards.

- 1 Remove the logic board.
- 2 Look at the resistor located at R-363 on the bottom of the board.



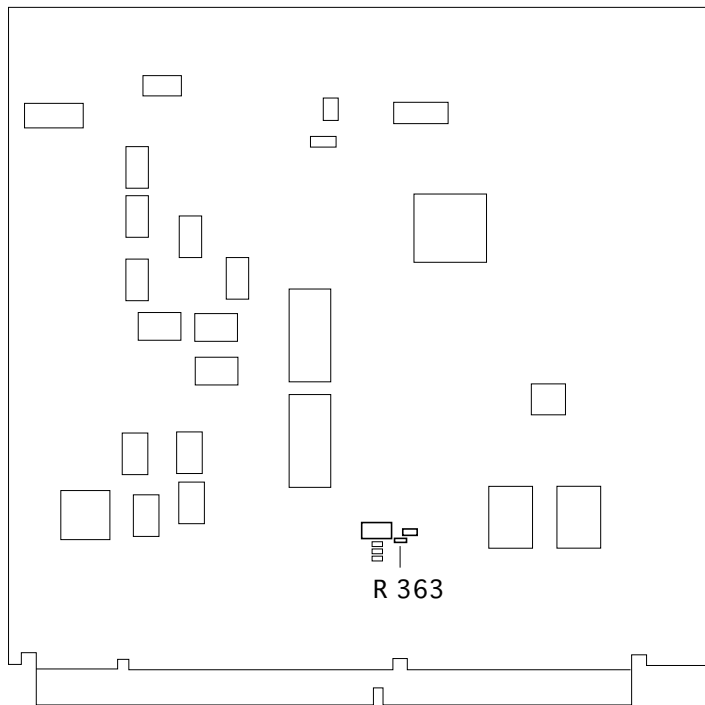

- 3 You may need to use a magnifying glass to see the print on this resistor.

If 100 is printed on the resistor, the board has not been reworked.

If 101 is printed on the resistor, the board has been reworked.

- 4 Replace a board that has not been reworked with a reworked logic board.





## Blurry Video Solution

If you identified a blurry video symptom, you need to inspect the audio/monitor connection subassembly.

- 1 Remove the audio/monitor connection subassembly from the computer.
- 2 Turn the subassembly so you can see the area of the monitor board immediately behind the monitor connector.

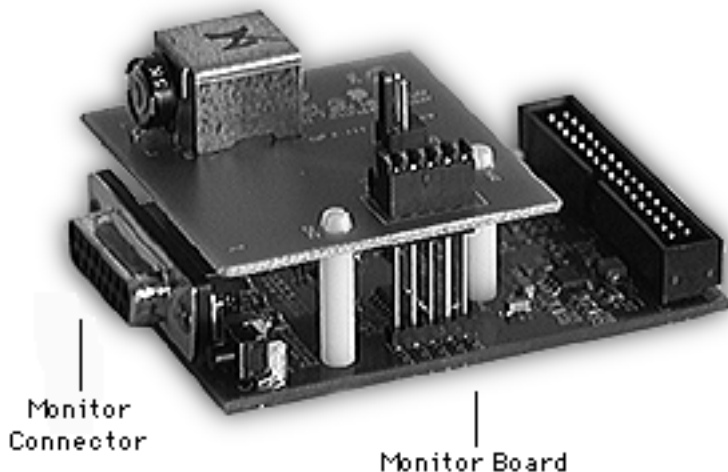

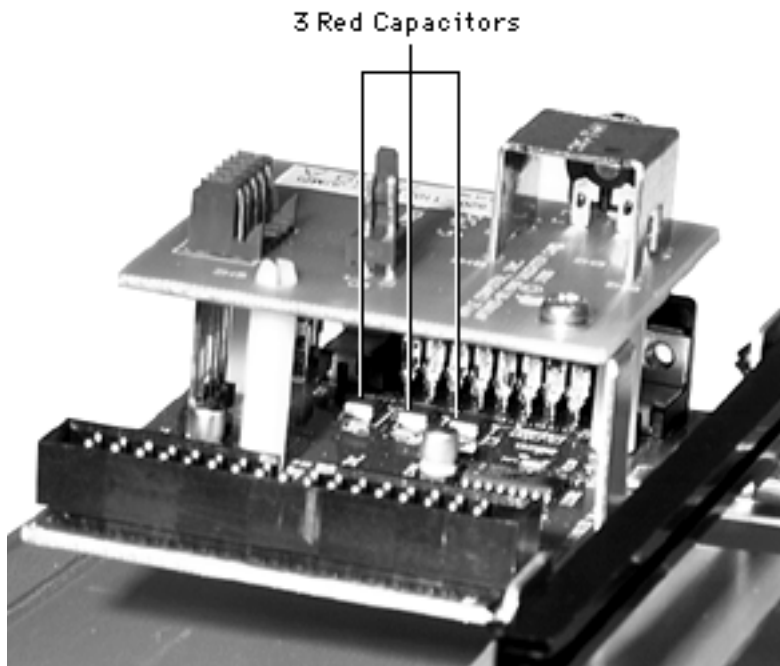

- 3 Look for three red capacitors as pictured in this graphic.

**Note:** The capacitors may not be present. See the graphic on the next page.





3 Red Capacitors NOT Present

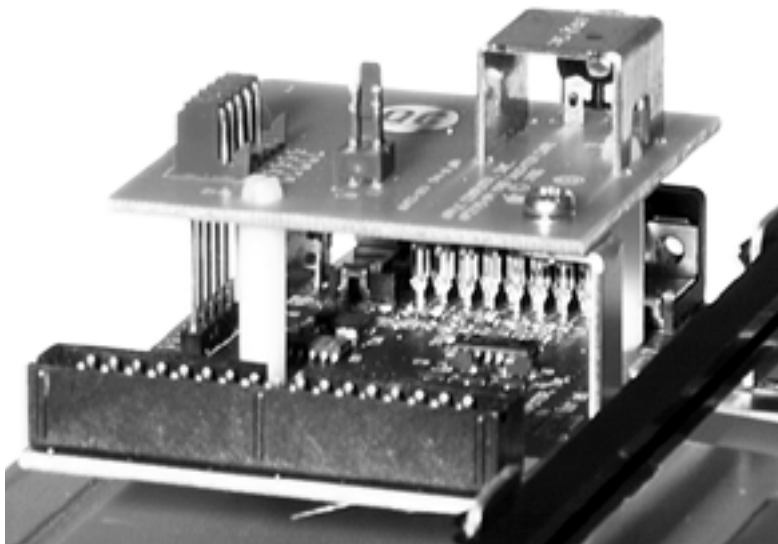

- 4 If three red capacitors are not present, replace the audio/monitor connection subassembly with part number 922-2996.





## 6500—Software Installation Errors and L2 Cache Identification

The symptoms during software installation on a Power Macintosh 6500 may appear as follows:

- The installation is interrupted by a dialog box displaying a message like this: “Unable to decompress file ‘xxxx’ because of a data mismatch error.” After dismissing the dialog box, the user may be able to continue installing or may only have the option to stop the installation, depending on the type of installer.
- During software installation, the system hangs (cursor arrow still moves), system freezes (cursor arrow does not move), or Type 10 errors are displayed requiring a reboot.







These symptoms may appear with any software, installer, and installation from CDs, floppy disks, Zip disks, or external hard drives.

## **Identifying Suspect Units**

This problem is caused by a combination of a certain logic board manufacturer (OPC) together with a certain L2 cache in a small percentage of Power Macintosh 6500 computers that fall within this serial number range:

PM 6500 from XB708xxxxx to XB718xxxxx





## **Recommended Action**

If the symptom occurs on a 6500 computer in the specified serial number range, inspect the logic board for “OPC” printed along the edge. If the logic board has “OPC” on it, verify the cache is a compatible L2 cache DIMM. If the logic board is an OPC with an incompatible L2 cache, replace the incompatible L2 cache with part number 661-1477.

## **Identifying an OPC Logic Board**

Here is how to positively identify an OPC logic board:

- 1 With the logic board connector closest to you, examine the right and left edges of the board.
- 2 Along the right or left side you may see the letters OPC.





## Identifying L2 Cache DIMM

If the logic board is an OPC, follow these instructions to positively identify the L2 cache DIMM as compatible or incompatible:

- 1 View the back of the cache DIMM.
- 2 Notice that there is one larger chip and eight smaller chips. The eight smaller chips are organized in two groups of four at each end of the DIMM.
- 3 Look at the markings on any one of the smaller chips. They will look similar to this:

IDT 74FST

32384Q (This number is the identifying factor.)

F9637BFU

If this number, not counting the Q or any other letters present, has five digits, it is compatible with OPC.





IDT 74FST  
3384Q (Use this number to identify a problem DIMM.)  
F9637BFU

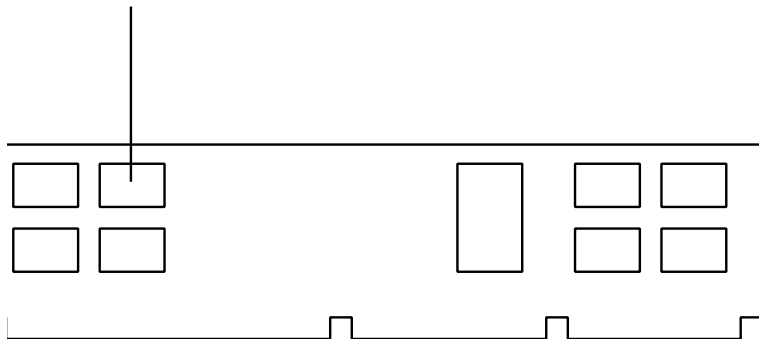

If this number, not counting the Q or any other letters present, has four digits, the cache is incompatible with an OPC logic board. Replace this L2 cache DIMM with part number 661-1477.





## Processor Fan

If the processor fan fails, the fan (922-3859) can be ordered separately and replaced.

- 1 Remove the I/O door.
- 2 Pull out the logic board.
- 3 Remove the defective processor fan.

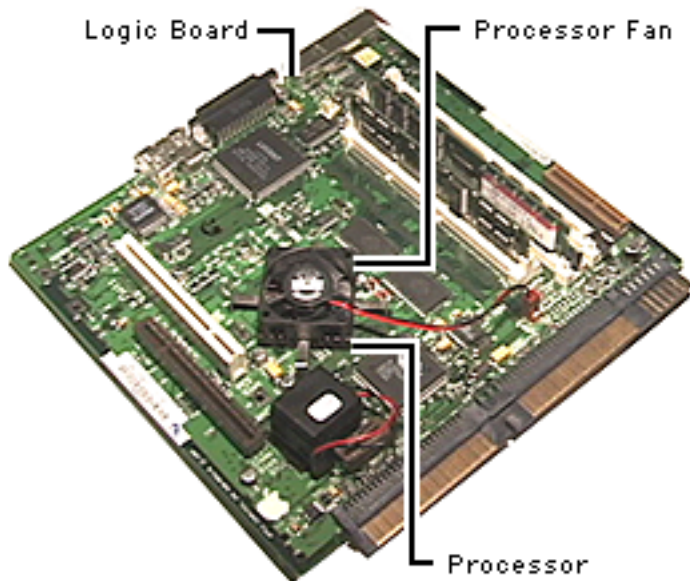

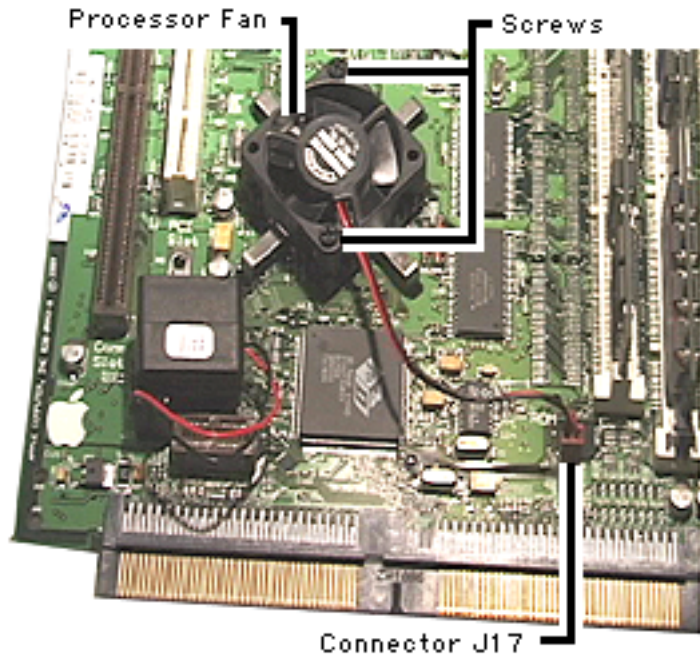

- 4 Replace the defective fan with the replacement part.
- 5 Position the fan as shown in the graphic. Attach the two black plastic screws.
- 6 Connect the fan to the logic board at J17.
- 7 Replace the logic board.
- 8 Replace the I/O door.





## Exploded View

---

Performa/Power Macintosh  
6400 and 6500 Series



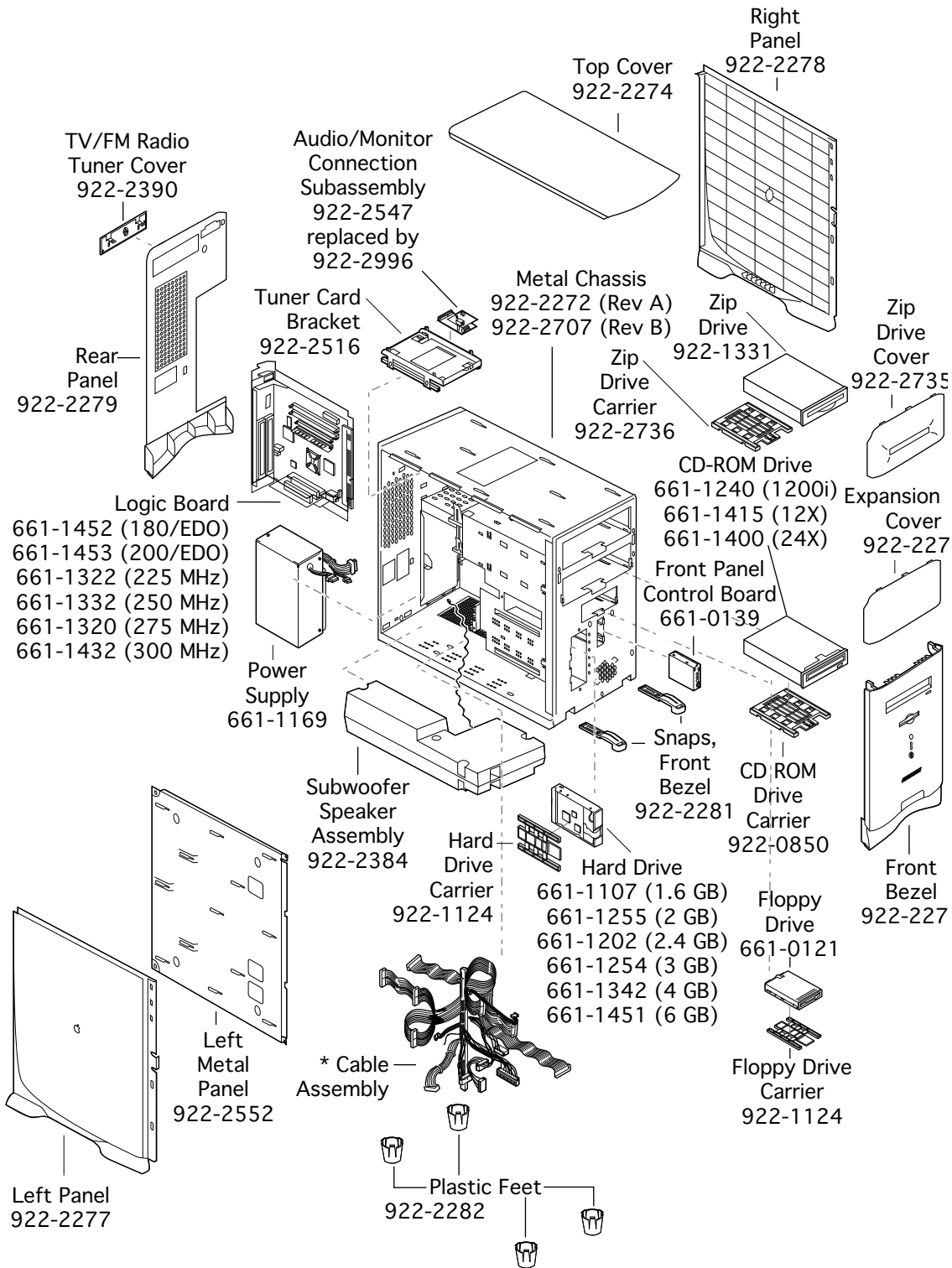

\* The cable harness must be ordered as part of the metal chassis.  
Cables are not available to order or replace separately.

