



Power Macintosh 7300/ 7500/7600 & WS 7350

PM 7300/166 (Europe/Japan only), 7300/180 & 180PC, 7300/200, 7500/100, 7600/120, 7600/132, 7600/200 (Japan only), and WS 7350/180





Basics

Power Macintosh 7300/7500/
7600 & WS 7350





Overview

The Power Macintosh 7300, 7500, and 7600 and WS 7350 share the same housing and feature a chassis design that allows you to access the logic board and its components (including the plug-in microprocessor card) without having to remove the power supply or any drives. This flexible design makes these systems easy to service and upgrade.

Features of the Power Macintosh 7300 include

- A 166, 180, or 200 MHz PowerPC™ 604e microprocessor card with built-in FPU and 256K cache
- 16 or 32 MB of DRAM, expandable to 512 MB using 168-pin, 70 ns, 64-bit DIMMs
- 2 MB VRAM, expandable to 4 MB
- 2 GB hard drive
- Three PCI expansion slots





- Two SCSI DMA buses supporting up to eight SCSI devices and transfers up to 10 MB/s (internal bus only)
- Built-in AAUI and 10BASE-T Ethernet
- Two GeoPort serial ports
- CD-ROM drive at 12x speed
- CD-quality stereo sound in/out
- Mac™ OS system software 7.5.5

Features of the Power Macintosh 7300/180 PC Compatible include

A 180 MHz PowerPC™ 604e microprocessor card with built-in FPU and 256K cache

- 32 MB of DRAM, expandable to 512 MB using 168-pin, 70 ns, 64-bit DIMMs
- 2 MB VRAM, expandable to 4 MB
- 2 GB hard drive
- Three PCI expansion slots





- Two SCSI DMA buses supporting up to eight SCSI devices and transfers up to 10 MB/s (internal bus only)
- Built-in AAUI and 10BASE-T Ethernet
- Two GeoPort serial ports
- CD-ROM drive at 12x speed
- CD-quality stereo sound in/out
- Mac™ OS system software 7.6.1
- 166 MHz Pentium processor card with FPU, 256K Level 2 cache, 16 MB of DRAM (expandable to 80 MB), 2 MB of video DRAM
- Windows 95 system software preinstalled

Features of the Power Macintosh 7500 include

- A 100 MHz PowerPC 601 microprocessor card with built-in FPU and optional Level 2 cache
- 8 or 16 MB DRAM expansion up to 512 MB using 168-pin, 70 ns, 64-bit DIMMs
- 2 MB VRAM, expandable to 4 MB





- 500 MB or 1 GB hard drive
- Two SCSI DMA buses supporting up to eight SCSI devices and transfers up to 10 MB/s (internal bus only)
- Three PCI expansion slots
- One Digital Audio Video (DAV) slot
- Video-in support via external ports
- Built-in AAUI and 10BASE-T Ethernet
- Two GeoPort serial ports
- CD-ROM drive at 4x speed
- CD-quality stereo sound in/out
- Mac OS system software 7.5.2

Features of the Power Macintosh 7600 (U.S.) include

- A 120 or 132 MHz PowerPC 604 microprocessor card with built-in FPU and 256K cache
- 16 MB of DRAM, expandable to 512 MB using 168-pin, 70 ns, 64-bit DIMMs
- 2 MB VRAM, expandable to 4 MB





- 1.2 GB hard drive
- Two SCSI DMA buses supporting up to eight SCSI devices and transfers up to 10 MB/s (internal bus only)
- Three PCI expansion slots
- One Digital Audio Video (DAV) slot
- Video-in support via external ports
- Built-in AAUI and 10BASE-T Ethernet
- Two GeoPort serial ports
- CD-ROM drive at 4x or 8x speed
- CD-quality stereo sound in/out
- Mac OS system software 7.5.3

Features of the Power Macintosh 7600/200 (Japan only) include

- A 200 MHz PowerPC 604e microprocessor card with built-in FPU and 256K cache
- 32 MB of DRAM, expandable to 512 MB using 168-pin, 70 ns, 64-bit DIMMs





- 2 MB VRAM, expandable to 4 MB
- 2 GB hard drive
- Two SCSI DMA buses supporting up to eight SCSI devices and transfers up to 10 MB/s (internal bus only)
- Three PCI expansion slots
- One Digital Audio Video (DAV) slot
- Video-in support via external ports
- Built-in AAUI and 10BASE-T Ethernet
- Two GeoPort serial ports
- CD-ROM drive at 12x speed
- CD-quality stereo sound in/out
- Support for TCP/IP networking software with Apple Open Transport
- Mac OS system software 7.5.5

Features of the Workgroup Server 7350/180 include

- A 180 MHz PowerPC 604e microprocessor card with built-in FPU, 64K on-chip cache, and 256K Level 2





cache

- 48 MB of DRAM, expandable to 512 MB using 168-pin, 70 ns, 64-bit DIMMs
- 2 MB VRAM, expandable to 4 MB
- 4 GB hard drive
- Two SCSI DMA buses supporting up to eight SCSI devices and transfers up to 10 MB/s (internal bus only)
- Three PCI expansion slots
- Built-in AAUI and 10BASE-T Ethernet
- Two GeoPort serial ports
- CD-ROM drive at 12x speed
- CD-quality stereo sound in/out
- Mac™ OS system software 7.6.1
- Apple RAID 1.5

The Power Macintosh 7300, 7500, and 7600 Series and WS 7350 computer is pictured on the following page.





Figure: PM 7300/7500/7600 & WS 7350 Computer





Configurations

The Power Macintosh 7300/166 comes standard with

- 166 MHz PowerPC 604e microprocessor card
- 16 MB DRAM
- 2 GB hard drive
- AppleCD 1800i 12x CD-ROM drive
- 2 MB of VRAM
- 256K Level 2 cache

The Power Macintosh 7300/180 comes standard with

- 180 MHz PowerPC 604e microprocessor card
- 16 MB DRAM
- 2 GB hard drive
- AppleCD 1800i 12x CD-ROM drive
- 2 MB of VRAM
- 256K Level 2 cache





The Power Macintosh 7300/180 PC Compatible comes standard with

- 180 MHz PowerPC 604e microprocessor card
- 32 MB of DRAM
- 2 GB hard drive
- AppleCD 1800i 12x CD-ROM drive
- 2 MB of VRAM
- 256K Level 2 cache
- 166 MHz Pentium processor card with FPU, 256K Level 2 cache, 16 MB of DRAM, 2 MB of video DRAM

The Power Macintosh 7300/200 comes standard with

- 200 MHz PowerPC 604e microprocessor card
- 32 MB DRAM
- 2 GB hard drive
- AppleCD 1800i 12x CD-ROM drive
- 2 MB of VRAM
- 256K Level 2 cache





The Power Macintosh 7500/100 comes standard with

- 100 MHz PowerPC 601 microprocessor card
- 8/16 MB DRAM
- 500 MB or 1 GB hard drive
- AppleCD 600i 4x CD-ROM drive
- 2 MB of VRAM

The Power Macintosh 7600/120 comes standard with

- 120 MHz PowerPC 604 microprocessor card
- 16 MB DRAM
- 1.2 GB hard drive
- AppleCD 600i 4x CD-ROM drive
- 2 MB of VRAM





The Power Macintosh 7600/132 comes standard with

- 132 MHz PowerPC 604 microprocessor card
- 16 MB DRAM
- 1.2 GB hard drive
- AppleCD 1200i 8x CD-ROM drive
- 2 MB of VRAM

The Power Macintosh 7600/200 comes standard with

- 200 MHz PowerPC 604e microprocessor card
- 32 MB DRAM
- 2 GB hard drive
- AppleCD 1800i 12x CD-ROM drive
- 2 MB of VRAM
- 256K Level 2 cache





The Workgroup Server 7350/180 comes standard with

- 180 MHz PowerPC 604e microprocessor card
- 48 MB DRAM
- 4 GB hard drive
- AppleCD 12x CD-ROM drive
- 2 MB of VRAM
- 256K Level 2 cache

In addition, there are three solution bundles for the WS 7350/180:

- Application Server Solution
- AppleShare Server Solution
- Apple Internet Server Solution





PowerPC 601 Microprocessor

The Power Macintosh 7500/100 features the PowerPC 601 RISC microprocessor. The PowerPC 601 microprocessor is installed via a card that plugs into the Macintosh 7500/100 logic board, allowing for maximum flexibility with future upgrades.

Features of the microprocessor include

- Full RISC processor architecture
- 32-bit addressing
- 64-bit data bus
- Built-in FPU
- 32K cache for data and instructions
- Internal Memory Management Unit (MMU)
- Advanced branching techniques for improved throughput





PowerPC 604 and 604e Microprocessor

The Power Macintosh 7300 and 7600 and Workgroup Server 7350 computers feature the PowerPC 604 and 604e RISC microprocessor. The microprocessor is installed via a card that plugs into the logic board, allowing for maximum flexibility with future upgrades.

Features of the microprocessor include

- Full RISC processing architecture
- Parallel processing units: one load-store unit, two integer units, one complex integer unit, and one floating point unit
- Separate built-in caches for data and instructions, 16K each for the 604 and 32K each for the 604e
- Advanced branching techniques for improved throughput
- Bus multiplier up to 3:1 for the 604 and up to 5:1 for the 604e





Peripheral Component Interconnect (PCI)

All the computer systems covered in this manual offer a Peripheral Component Interconnect (PCI) expansion bus. Because the PCI bus is an industry standard, most existing PCI 2.0-compliant cards (with the addition of a Mac OS-specific software driver) will work in these computers.

PCI offers significantly higher performance than the NuBus architecture used in previous Macintosh models. Running at 33 MHz, the PCI bus is up to three times faster than NuBus, offering overall enhanced system performance, particularly in the areas of video and networking.





Dual In-Line Memory Modules (DIMMs)

All the computer systems covered in this manual use DRAM Dual In-Line Memory Modules (DIMMs) instead of DRAM SIMMs. Whereas SIMMs have 72 pins, DIMMs have 168 pins. The extra pins provide a 64-bit data path, compared to a 32-bit data path for SIMMs. In addition, DIMMs do not have to be installed in pairs like the SIMMs on earlier Macintosh models. (However, to take advantage of memory interleaving, the DIMMs should be installed in paired slots. See “Memory Configurations” in Basics for more information.)

Important: These computers use +5 V DIMMs only. Single In-Line Memory Modules (SIMMs) used in previous Macintosh models are NOT compatible with these computers.





Important: These computers also use VRAM DIMMs (112-pin 70 ns or faster) instead of VRAM SIMMs. The VRAM SIMMs used in earlier Power Macintosh models are not compatible.

Note: While the Power Macintosh 7300 Series, the Power Macintosh 7600/200, and the Workgroup Server 7350/180 ship with EDO DIMMs, the computers' memory controller treats EDO DIMMs like fast-paged DIMMs. You can therefore use either EDO or fast-paged DIMMs in these computers.





Memory Configurations

All the computer systems covered in this manual have eight DRAM DIMM slots on the logic board, each with a 64-bit data bus. You can increase the computers' DRAM to a total of 512 MB using 5-volt, 64-bit-wide, 168-pin fast-paged mode, 70 ns DIMMs. (You can also use EDO DIMMs in the PM 7300 Series, 7600/200, and WS 7350/180. See the note on the previous page for more information.)

Note: These computers do not have any main memory soldered to the logic board. At least one RAM DIMM must be present for the computers to operate.

DRAM DIMMs can be installed individually; however, to take advantage of the computer's interleaving capability, which provides maximum performance, you must install the DIMMs in matching pairs and in paired slots.





Note: Memory interleaving allows the computer to read or write to its memory while other memory reads or writes are occurring, thus providing for faster performance.

For a pair of DIMMs to function as a single 128-bit wide pair, they must be the same type and size.

Note: DIMMs purchased from different manufacturers can be paired as long as they are the same size and speed.

The drawing on the following page illustrates where the DRAM slots are located on the Power Macintosh 7300, 7500, 7600 and WS 7350 logic boards and how they are numbered.



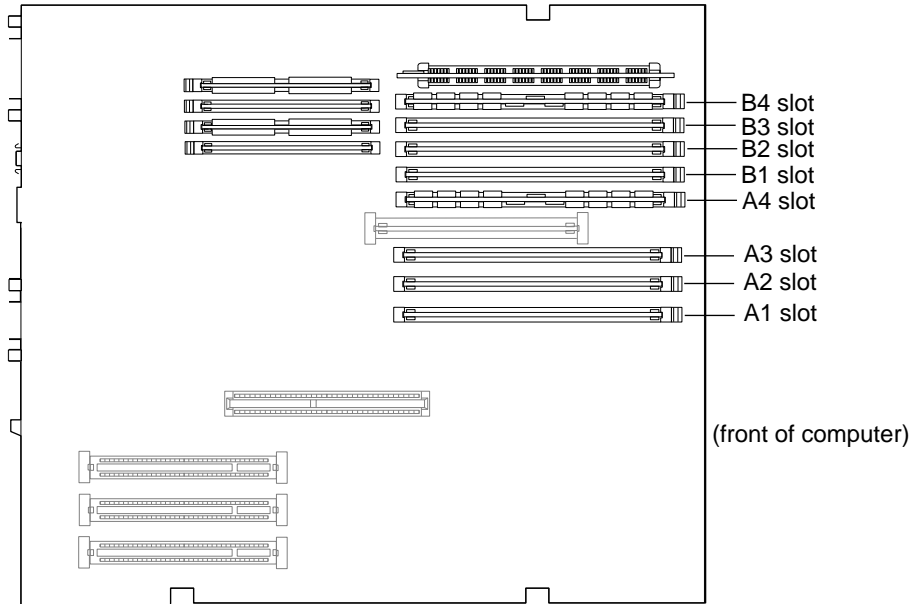

Figure: DRAM Slots on PM 7300/7500/7600 & WS 7350





Ethernet Support

There are two Ethernet ports on the logic board: an AAUI port and a 10BASE-T port. You can use only one Ethernet port at one time, however. If you have cables plugged into both Ethernet ports, the computer uses the 10BASE-T port by default.





AV Support

The Power Macintosh 7500 and 7600 computers come standard with an AV module that provides support for: composite video and S-video input, audio input (left and right), and audio output (left and right). The Power Macintosh 7300 and WS 7350 computers do not include an AV module.

PC Compatibility Cards

Apple computer offers PC Compatibility Card upgrade kits that bring full DOS functionality to the Power Macintosh 7300, 7500, and 7600 computers. The cards plug into any available PCI slot on the logic board. Refer to the Upgrades chapter in this manual for installation instructions.





GeoPort

Geoport is a hardware and software communications architecture that has been optimized for computer-telephony integration. It has three main attributes:

- It lets any computer connect to any telephone (analog or digital, public or private) anywhere in the world.
- Once connected, it supports an arbitrary number of independent data streams up to a total bandwidth of 2 MB/second.
- Unlike traditional asynchronous data communications (such as AppleTalk), GeoPort also supports isochronous data streams (such as real-time voice and video) and provides the real-time Application Program Interfaces (APIs) necessary to hide the implementation details from both the recipient and the sender.





By attaching an Apple GeoPort Telecom Adapter to the Power Macintosh 7300, 7500, or 7600, you can enjoy all the features of a 33.6 modem, including data, fax, send and receive, and voice capabilities. The GeoPort Telecom Adapter serves as a line interface to standard (analog) telephone lines. The adapter is capable of sending or receiving data at up to 33.6 kbps and faxes at up to 14.4 kbps using the GeoPort Telecom Adapter software.





The Cuda Chip

The Cuda is a microcontroller chip. Its function is to

- Turn system power on and off
- Manage system resets from various commands
- Maintain parameter RAM (PRAM)
- Manage the Apple Desktop Bus (ADB)
- Manage the real-time clock

Many system problems can be resolved by resetting the Cuda chip (see Symptom Charts for examples). Press the Cuda reset button on the logic board to reset the Cuda chip. (See "Logic Board Diagram" later in this chapter to locate the Cuda reset button.) If you continue to experience system problems, refer to "Resetting the Logic Board" later in this Basics chapter.





Resetting the Logic Board

Resetting the logic board can resolve many system problems (refer to "Symptom Charts" for examples). Whenever you have a unit that fails to power up, you should follow this procedure before replacing any modules.

- 1 Unplug the computer.
- 2 Remove the battery from the logic board. (See Take Apart for instructions on how to remove the battery.)
- 3 Disconnect the power supply cable from the logic board and then press the Power On button. (See "Logic Board Diagram" later in this chapter to locate the Power On button.)
- 4 Wait at least 10 minutes before replacing the battery.





- 5 Make sure the battery is installed in the correct +/- direction.
- 6 Reassemble the computer and test the unit.

Note: This procedure resets the computer's PRAM. Be sure to check the computer's time/date and other system parameter settings afterwards.

Note: If this procedure resolves the problem, claim an adjustment on an SRO. If not, replace the defective component and DO NOT claim the adjustment procedure.





Fast SCSI

All the computer systems covered in this manual offer Fast SCSI support on the internal SCSI connector, which provides for significantly enhanced data throughput. The internal SCSI bus on these computers supports transfer rates up to 10 MB/sec.





Rear View Diagram

The drawing on the next page illustrates the rear panel connectors on the Power Macintosh 7300, 7500, 7600 and WS 7350 computers, which include the following ports: SCSI, AAUI Ethernet, 10BASE-T Ethernet, serial printer (GeoPort compatible), serial modem (GeoPort compatible), DB-15 video, ADB, sound input, sound output, composite video input (Power Macintosh 7500 and 7600 only), S-video input (Power Macintosh 7500 and 7600 only), left and right audio input (Power Macintosh 7500 and 7600 only), left and right audio output (Power Macintosh 7500 and 7600 only).



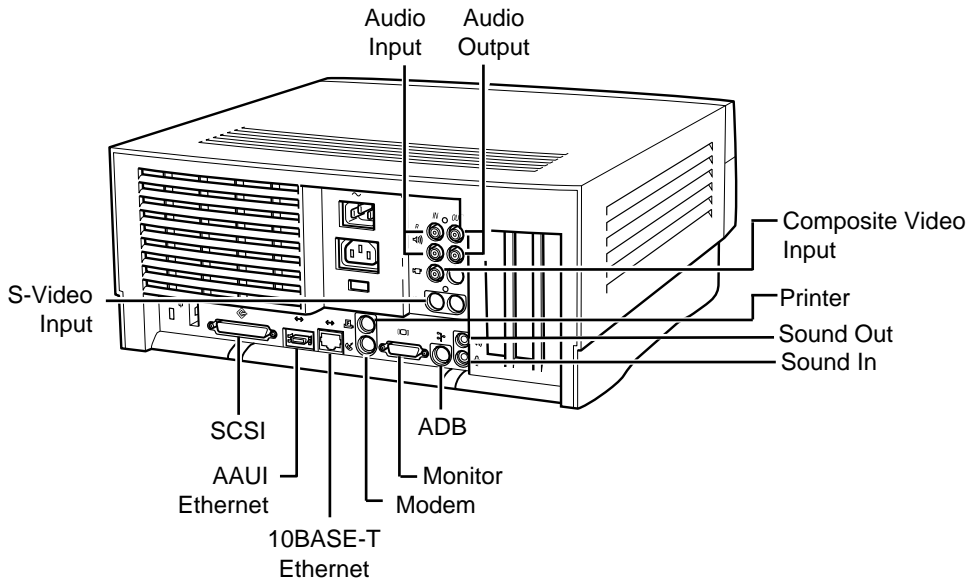

Figure: Rear Panel





Logic Board Diagram

The following drawing illustrates the connectors on the Power Macintosh 7300, 7500, 7600 and WS 7350 logic boards.

Note: Some versions of the logic boards have a ROM SIMM while other versions have the ROM soldered on the logic board.



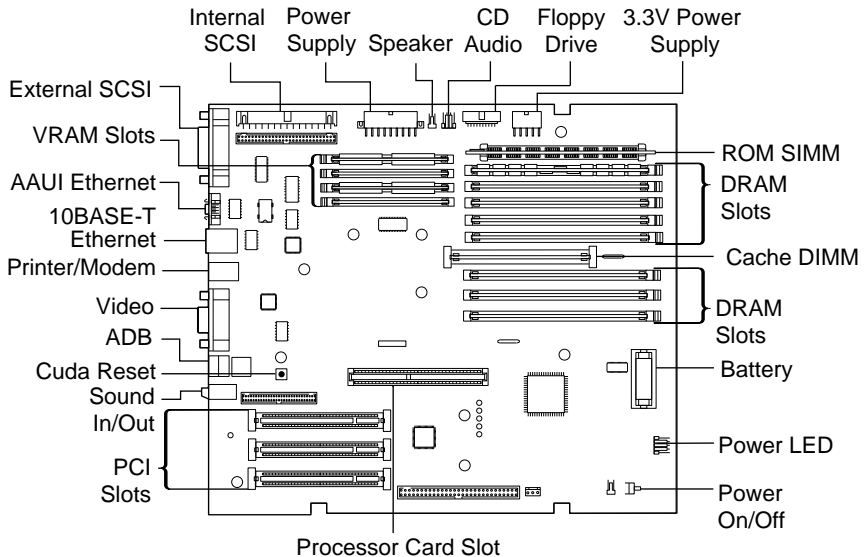

Figure: PM 7300, 7500, 7600 & WS 7350 Logic Board





Repair Strategy

Service the Power Macintosh 7300, 7500, 7600, and WS 7350 computers through module exchange and parts replacement. Customers can request on-site service from an Apple Authorized Service Provider Plus (AASP+) or Apple Assurance. They can also choose carry-in service from an AASP.

Ordering

Apple Service Providers planning to support the computer systems covered in this manual may purchase Service modules and parts to develop servicing capability. To order parts, use the AppleOrder system and refer to the Power Macintosh 7300, 7500, 7600, or WS 7350 "Service Price Pages."





Large businesses, universities, and K-12 accounts must provide a purchase order on all transactions, including orders placed through the AppleOrder system. Service providers not enrolled in AppleOrder may fax their orders to Service Provider Support (512-908-8125) or mail them to

Apple Computer, Inc.
Service Provider Support
MS 212-SPS
Austin, TX 78714-9125

If you have further questions, please call Service Provider Support at 800-919-2775 and select option #1.





Warranty and AppleCare

The Power Macintosh 7300, 7500, 7600, and WS 7350 computers are covered under the Apple One-Year Limited Warranty. The AppleCare Service Plan is also available for these products. Service Providers are reimbursed for warranty and AppleCare repairs made to these computers. For pricing information, refer to "Service Price Pages."





Specifications

Power Macintosh 7300/7500/
7600 & WS 7350





Processor

CPU

**PM 7300/166
(Europe and Japan)**

PowerPC 604e RISC microprocessor running at 166 MHz
Built-in FPU
Requires system software version 7.5.5 or later

PM 7300/180

PowerPC 604e RISC microprocessor running at 180 MHz
Built-in FPU
Requires system software version 7.5.5 or later

PM 7300/180 PC

PowerPC 604e RISC microprocessor running at 180 MHz
Built-in FPU
Requires system software version 7.6.1 or later
Pentium processor with FPU running at 166 MHz



**PM 7300/200**

PowerPC 604e RISC microprocessor running at 200 MHz
Built-in FPU
Requires system software version 7.5.5 or later

PM 7500/100

PowerPC 601 RISC microprocessor running at 100 MHz
Built-in FPU
Requires system software version 7.5.2 or later with appropriate
Enabler version

PM 7600/120

PowerPC 604 RISC microprocessor running at 120 MHz
Built-in FPU
Requires system software version 7.5.3 or later with appropriate
Enabler version

PM 7600/132

PowerPC 604 RISC microprocessor running at 132 MHz
Built-in FPU
Requires system software version 7.5.3 Revision 2 or later





PM 7600/200 (Japan)

PowerPC 604e RISC microprocessor running at 200 MHz
Built-in FPU
Requires system software version 7.5.5 or later

WS 7350/180

PowerPC 604e RISC microprocessor running at 180 MHz
Built-in FPU
Requires system software version 7.6.1 or later





Memory

DRAM

PM 7300 Series	16 or 32 MB standard; expandable to 512 MB Uses 168-pin, 64-bit, 60 ns or faster EDO DRAM DIMMs
PM 7500/100	8 or 16 MB standard; expandable to 512 MB Uses 168-pin, 64-bit, 70 ns or faster DRAM DIMMs
PM 7600/120 and 7600/132	16 or 32 MB standard; expandable to 512 MB Uses 168-pin, 64-bit, 70 ns or faster DRAM DIMMs
PM 7600/200 (Japan)	16 or 32 MB standard; expandable to 512 MB Uses 168-pin, 64-bit, 60 ns or faster EDO DRAM DIMMs



**WS 7350/180**

48 MB standard; expandable to 512 MB
Uses 168-pin, 64-bit, 70 ns or faster DRAM DIMMs

Cache

Supports 256K, 512K, or 1 MB Level 2 cache DIMM (160-pin,
11 ns)

ROM

4 MB ROM (may be installed in ROM SIMM slot, or soldered on the
logic board)

Clock/Calendar

CMOS custom circuitry with long-life battery





I/O Interfaces

- SCSI** Dual-channel asynchronous SCSI interface; external channel supports up to seven SCSI devices; internal channel supports a hard disk array
- Serial** Two RS-232/RS-422 serial ports compatible with LocalTalk and GeoPort cables; mini DIN-9 connectors
- ADB** One Apple Desktop Bus port for a keyboard, mouse, etc.
- Ethernet** One AAUI and one 10BASE-T Ethernet port (if cables are plugged into both ports, system defaults to 10BASE-T)





Expansion

Three PCI expansion slots, compatible with all PCI 2.0 specification-compliant cards with the addition of Mac OS-specific software driver (not NuBus compatible)

Sound

16-bit stereo sound input and output ports

Video

Built-in DB-15 video connector on logic board

PM 7500 and 7600 Series

24-bit video input connectors on AV module





I/O Devices

Keyboard

Standard, extended, or adjustable keyboard; keyboard draws 25-80 mA, depending on model type

Mouse

ADB Mouse II; mouse draws up to 10 mA

Microphone

Apple PlainTalk microphone standard





Video Support

Table 1: Video Table

MONITOR DISPLAY SIZE	PIXEL DEPTHS	
	2 MB VRAM*	4 MB VRAM*
512 by 384	8, 16, 32	8, 16, 32
640 by 480	8, 16, 32	8, 16, 32
768 by 576	8, 16, 32	8, 16, 32
800 by 600	8, 16, 32	8, 16, 32
832 by 624	8, 16, 32	8, 16, 32
1024 by 768	8, 16	8, 16, 32
1152 by 870	8, 16	8, 16



**Table 1: Video Table**

	PIXEL DEPTHS	
MONITOR DISPLAY SIZE	2 MB VRAM*	4 MB VRAM*
1280 by 960	8	8, 16
1280 by 1024	8	8, 16

*The Power Macintosh 7300, 7500, and 7600, and WS 7350 computers do not have any VRAM soldered on the logic board; VRAM DIMMs must be present to display any video. The computer comes with two 1 MB VRAM DIMMs installed. You can upgrade to 4 MB of VRAM by installing two more 1 MB VRAM DIMMs in the remaining slots. VRAM DIMMs must be installed in matching pairs and in paired slots.





Disk Storage

Hard Drive

PM 7300 Series	2 GB fast internal SCSI hard drive
PM 7500/100	500 MB or 1 GB fast internal SCSI hard drive
PM 7600 Series	1.2 GB fast internal SCSI hard drive
PM 7600/200 (Japan)	2 GB fast internal SCSI hard drive
WS 7350/180	4 GB fast internal SCSI hard drive

Floppy Drive

One Apple SuperDrive 1.4 MB floppy drive





CD-ROM Drive

PM 7300 Series	One internal AppleCD 1800i 12x CD-ROM drive
PM 7500/100	One internal AppleCD 600i 4x CD-ROM drive
PM 7600/120	One internal AppleCD 600i 4x CD-ROM drive
PM 7600/132	One internal AppleCD 1200i 8x CD-ROM drive
PM 7600/200 (Japan)	One internal AppleCD 1800i 12x CD-ROM drive
WS 7350/180	One internal AppleCD 1800i 12x CD-ROM drive





Electrical

Line Voltage	100-240 VAC, RMS single phase, automatically configured
Frequency	50-60 Hz, single phase
Maximum Power	150 W maximum, not including monitor





Physical

Dimensions

Height:	6.15 in. (15.6 cm)
Width:	14.37 in. (36.5 cm)
Depth:	16.93 in. (43.0 cm)
Weight:	22 lb. (9.97 kg); weight varies depending on devices installed





Environmental

**Operating
Temperature**

50 to 104° F (10 to 40° C)

**Storage
Temperature**

-40 to 116° F (-40 to 47° C)

Relative Humidity

5-95% noncondensing

Maximum Altitude

10,000 ft. (3,048 m)





Troubleshooting

Power Macintosh 7300/7500/
7600 & WS 7350





General

The Symptom Charts included in this chapter will help you diagnose specific symptoms related to your product. Because cures are listed on the charts in the order of most likely solution, try the first cure first. Verify whether or not the product continues to exhibit the symptom. If the symptom persists, try the next cure. (Note: If you have replaced a module, reinstall the original module before you proceed to the next cure.)

If you are not sure what the problem is, or if the Symptom Charts do not resolve the problem, refer to the Flowchart for the product family.

For additional assistance, contact Apple Technical Support.





Cleaning Procedure for Card Connectors

It is possible for residue to build up on the gold edge connector pins on some PCI cards, which could cause a variety of symptoms.

If you are having problems with a PCI card, inspect the connector pins with a magnifying glass. If you find residue, use a pencil eraser to gently clean the pins.





2/3/4/6 GB Firmware Utility 1.0

The 2/3/4/6 GB Firmware Utility 1.0 (which supercedes the 2 GB/4 GB Download Utility version 1.0) was released November 20, 1997. It is used to update the firmware on 2, 3, 4, and 6 GB SCSI hard drives in some Power Macintosh configurations with firmware versions other than 0F0J. This utility can be used on international versions of Mac OS as well as U.S. Mac OS versions.

This bootable disk image contains a utility to fix a problem with a limited number of 2, 3, 4, and 6 GB SCSI hard drives in some Power Macintosh and Performa configurations that may experience a problem waking after the machines has been set to the Sleep mode.

This software consists of a Disk Copy NDIF (New Disk Image Format) compressed image, which requires Disk Copy 6.1 or later to use. Download this software to your hard drive and then





double-click it to use it. Disk Copy is available in the Utilities folder. Disk Copy 6.1 (or later) or Disk Image Mounter 2.1 (or later) from Apple are the recommended applications to access all disk images released by Apple and are the only supported applications to access NDIF disk images.





Symptom Charts

Power Supply

System doesn't power up

- 1 Reseat processor card and ROM SIMM (if present).
- 2 On Power Macintosh 7500/100 systems only, check the cache DIMM. If cache DIMM has part number 820-0719-B printed on its PCB, remove DIMM and replace with part number 661-1310.
- 3 Reset Cuda chip. (Refer to “The Cuda Chip” in Basics for instructions.)
- 4 Reset logic board. (Refer to “Resetting the Logic Board” in Basics for instructions.)
- 5 Replace power supply.
- 6 Replace processor card.
- 7 Replace logic board.





Error Chords

One-part error chord sounds during startup sequence

- 1 Disconnect SCSI data cable from hard drive and reboot system. If startup sequence is normal, initialize hard drive. Test unit again with SCSI data cable connected. If error chord still sounds, replace hard drive.
- 2 Disconnect floppy drive cable from floppy drive and reboot system. If startup sequence is normal, replace floppy drive.
- 3 Reseat processor card.
- 4 Replace processor card.
- 5 Replace logic board. Retain customer's DIMMs.

Eight-part error chord (death chimes) sounds during startup sequence

- 1 Replace DRAM DIMMs one at a time to test DRAM. Replace any faulty DIMMs.
- 2 Replace logic board.





System

Does not power on, screen is black, fan is not running and LED is not lit

- 1 Check power cables.
- 2 Plug monitor directly into wall socket, and verify that monitor has power.
- 3 Reseat ROM SIMM (if present) and processor card. The logic board must have a processor card installed to operate.
- 4 Reset Cuda chip. (Refer to “The Cuda Chip” in Basics for instructions.)
- 5 Reset logic board. (Refer to “Resetting the Logic Board” in Basics for instructions.)
- 6 Replace power cord.
- 7 Replace power supply.
- 8 Replace processor card.
- 9 Replace logic board. Retain customer’s DIMMs.





Clicking, chirping,
or thumping

- 1 Remove all PCI cards and test the unit. If problem does not occur with cards removed, begin replacing them one at a time to determine which card is causing the problem. Replace problem card with known-good card.
- 2 Remove hard drive. If problem no longer occurs, replace hard drive with a known-good drive.
- 3 Replace power supply.
- 4 Replace processor card.
- 5 Replace logic board. Retain customer's DIMMs.
- 6 Replace floppy drive cable.
- 7 Replace floppy drive.





System shuts down
intermittently

- 1 Make sure air vents are clear. Thermal protection circuitry may shut down system. After 30 to 40 minutes, system should be OK.
- 2 Make sure power cord is firmly plugged in.
- 3 Replace power cord.
- 4 Check battery.
- 5 Reset Cuda chip. (Refer to “The Cuda Chip” in Basics for instructions.)
- 6 Reset logic board. (Refer to “Resetting the Logic Board” in Basics for instructions.)
- 7 Replace power supply.
- 8 Replace processor card.
- 9 Replace logic board. Retain customer's DIMMs.





System
intermittently
crashes or hangs

- 1 Verify system software is version 7.5.2 or later (Power Macintosh 7500), 7.5.3 or later (Power Macintosh 7600), 7.5.5 or later (Power Macintosh 7300), or 7.6.1 or later (WS 7350).
- 2 If unit freezes coming out of sleep, or if there are other hard drive issues, use Apple System Profiler to check hard drive firmware revision. Use 2/3/4/6 GB Firmware Utility 1.0 if necessary, which can be found on Service Source CD or can be downloaded from Apple's software updates web site. **Note:** Download the image to a floppy disk, as opposed to drag/copying it to a floppy disk, or the utility will not update properly. (See “2/3/4/6 GB Firmware Utility 1.0” earlier in this chapter for more information.)
- 3 Verify DIMMs are noncomposite.
- 4 On Power Macintosh 7500/100 systems only, check the cache DIMM. If cache DIMM has part number 820-0719-B printed on its PCB, remove DIMM and replace with part number 661-1310.





- 5 Verify software is known-good. Do a clean install of the system software.
- 6 Verify software is Power Macintosh compatible (contact developer). Also, try booting with extensions off to determine if there are system init problems.
- 7 If system serial number is XB633XXX8L or less and system has a 132 MHz card installed, replace the card.
- 8 Clear parameter RAM. Hold down <Command> <Option> <P> <R> during startup but before "Welcome to Macintosh" appears.
- 9 Remove all DRAM DIMMs and try replacing them one at a time to test. Replace any bad DIMMs.
- 10 Replace processor card.
- 11 Replace logic board. Retain DIMMs.





During startup, following message is displayed, "This startup disk will not work on this Macintosh model...."

- 1 Verify startup disk is good.
- 2 Verify system software is version 7.5.2 or later (Power Macintosh 7500), 7.5.3 or later (Power Macintosh 7600), 7.5.5 or later (Power Macintosh 7300), or 7.6.1 or later (WS 7350).
- 3 Do a clean install of the system software.





Video

Screen is black, boot tone is present, drive operates, fan is running, and LED is lit

- 1 Adjust brightness on monitor.
- 2 Clear parameter RAM. Hold down <Command> <Option> <P> <R> during startup but before "Welcome to Macintosh" appears.
- 3 Reset Cuda chip. (Refer to "The Cuda Chip" in Basics.)
- 4 Reset logic board. (See "Resetting Logic Board" in Basics.)
- 5 Replace monitor cable.
- 6 Remove all DRAM DIMMs and try replacing them one at a time to test. Replace any bad DIMMs.
- 7 Test with known-good monitor. Replace monitor if necessary. Refer to appropriate monitor manual to troubleshoot defective monitor.
- 8 Replace processor card.
- 9 Replace logic board. Retain customer's DIMMs.





Screen is black, no boot tone and drive does not operate, but fan is running and LED is lit

- 1 Reset Cuda chip. (Refer to “The Cuda Chip” in Basics for instructions.)
- 2 Reset logic board. (Refer to “Resetting the Logic Board” in Basics for instructions.)
- 3 Remove all DRAM DIMMs and try replacing them one at a time to test. Replace any bad DIMMs.
- 4 Replace processor card.
- 5 Replace logic board. Retain customer's DIMMs.
- 6 Replace power supply.





Boot tone is present and screen lights up, but nothing is displayed on screen

- 1 Reset Cuda chip. (Refer to “The Cuda Chip” in Basics for instructions.)
- 2 Reset logic board. (Refer to “Resetting the Logic Board” in Basics for instructions.)
- 3 Replace monitor cable.
- 4 Test with known-good monitor. Replace monitor if necessary. Refer to appropriate monitor manual to troubleshoot defective monitor.
- 5 Replace processor card.
- 6 Replace logic board. Retain customer's DIMMs.





Video display distorted on Power Macintosh 7500 with DAV card installed

Symptom occurs when an add-in card attached to the DAV connector requires a mode configuration under which the add-in card controls most of the signal lines (Mode 2). Verify that the logic board installed supports DAV cards; if not, replace the logic board.

If the logic board in question meets **either** of the following criteria, then it DOES support DAV cards and you need not replace the board:

- Part number 820-0752 is silk-screened on the logic board.
- The Logic board has the wiring scenario shown on the next page.





NOTE: The dotted line indicates that the jumper wire is running underneath the logic board.

Jumper Wire

PCB Part Number

820-0564XX

U18

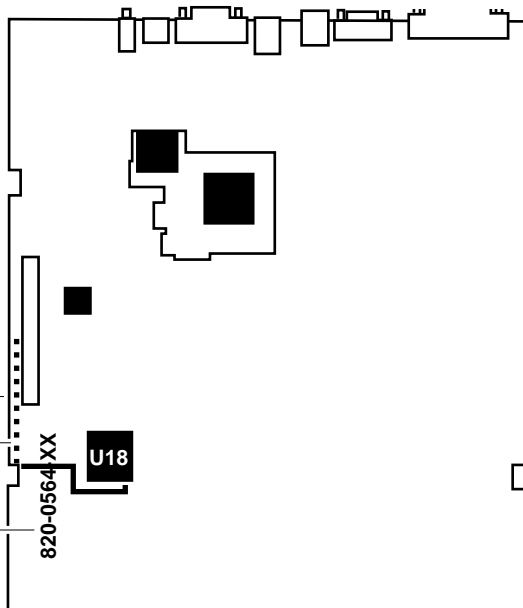

Power Macintosh 7500 Logic Board with DAV Fix





Floppy Drive

Internal floppy drive
does not operate

- 1 Replace floppy disk with known-good disk.
- 2 Replace floppy drive cable.
- 3 Replace floppy drive.
- 4 Replace processor card.
- 5 Replace logic board. Retain customer's DIMMs.

During system
startup, disk ejects;
display shows icon
with blinking "X"

- 1 Replace disk with known-good system disk.
- 2 Replace floppy drive cable.
- 3 Replace floppy drive.
- 4 Replace processor card.
- 5 Replace logic board. Retain customer's DIMMs.





- | | |
|---|---|
| Does not eject disk | <ol style="list-style-type: none"><li data-bbox="445 104 1415 182">1 Switch off computer. Hold mouse button down while you switch computer on.<li data-bbox="445 197 948 228">2 Replace floppy drive cable.<li data-bbox="445 244 856 275">3 Replace floppy drive.<li data-bbox="445 291 894 322">4 Replace processor card.<li data-bbox="445 337 1267 368">5 Replace logic board. Retain customer's DIMMs. |
| Attempts to eject disk, but doesn't | <ol style="list-style-type: none"><li data-bbox="445 436 1395 513">1 Reseat floppy drive bezel and drive so bezel slot aligns correctly with drive.<li data-bbox="445 529 856 560">2 Replace floppy drive. |
| Internal floppy drive runs continuously | <ol style="list-style-type: none"><li data-bbox="445 622 1198 653">1 Replace disk with known-good floppy disk.<li data-bbox="445 669 948 700">2 Replace floppy drive cable.<li data-bbox="445 715 856 746">3 Replace floppy drive.<li data-bbox="445 762 894 793">4 Replace processor card.<li data-bbox="445 809 1267 840">5 Replace logic board. Retain customer's DIMMs. |





MS-DOS drive does not recognize a disk formatted on a 1.4 MB drive

- 1 To read and write files with either MS-DOS or 1.4 MB drive, format all disks with MS-DOS drive first.





Hard Drive

Single internal hard drive does not operate; drive doesn't spin

- 1 Replace hard drive power cable.
- 2 Replace hard drive. If problem resolved, reinstall SCSI device driver and system software.
- 3 Replace power supply.

No internal SCSI drives operate

- 1 Verify there are no duplicate SCSI device addresses.
- 2 Disconnect external SCSI devices and check for proper termination. Only last device in SCSI chain should be terminated.
- 3 Replace SCSI data cable.
- 4 Replace power supply.
- 5 Replace processor card.
- 6 Replace logic board. Retain customer's DIMMs.





Drive does not appear on the desktop

- 1 Verify there are no duplicate SCSI device addresses.
- 2 Update the SCSI device driver using Drive Setup. Check drive's directory structure using Disk First Aid.
- 3 Replace SCSI hard drive cable.
- 4 If drive is not initialized, use Drive Setup to initialize.
- 5 Replace with known-good hard drive.
- 6 If hard drive still doesn't work, switch back to original hard drive and replace logic board.

Works with internal or external SCSI devices but not with both

- 1 Verify there are no duplicate SCSI device addresses.
- 2 Replace terminator on external SCSI device.
- 3 Verify that SCSI device at end of internal SCSI data cable is only device terminated.
- 4 Refer to appropriate manual to troubleshoot defective external device.





Peripherals

Cursor does not move

- 1 Check mouse connection.
- 2 Inspect inside of mouse for buildup of dirt or other contaminants. Clean mouse if necessary.
- 3 If mouse was connected to keyboard, connect mouse to computer ADB port instead. If mouse works, replace keyboard.
- 4 Replace ADB cable.
- 5 If mouse does not work in any ADB port on computer, replace mouse.
- 6 Replace processor card.
- 7 Replace logic board. Retain customer's DIMMs.

Cursor moves, but clicking mouse button has no effect

- 1 Boot from floppy or bootable CD.
- 2 Replace mouse.
- 3 Replace logic board. Retain customer's DIMMs.





Double-click doesn't open application, disk, or server

- 1 Remove duplicate system folders.
- 2 Clear parameter RAM. Hold down <Command> <Option> <P> <R> during startup but before "Welcome to Macintosh" appears.
- 3 If mouse was connected to keyboard, connect mouse to computer ADB port instead. If mouse works, replace keyboard.
- 4 If mouse does not work in any ADB port on computer, replace mouse.
- 5 Replace logic board. Retain customer's DIMMs.

No response to any key on keyboard

- 1 Check keyboard connection to ADB port.
- 2 Replace keyboard cable.
- 3 Replace keyboard.
- 4 Replace logic board. Retain customer's DIMMs.





Known-good serial printer does not work

- 1 Verify you have correct version of system software.
- 2 Verify that Chooser is set correctly.
- 3 Reinstall correct printer drivers.
- 4 Do clean install of system software.
- 5 Replace printer interface cable.
- 6 Replace logic board. Retain customer's DIMMs.

Known-good network printer does not print

- 1 Check network connections.
- 2 Verify you have correct version of system software.
- 3 Verify that Chooser is set correctly.
- 4 Does printer show up in Chooser? If so, do clean install of system software and/or network and printer software.
- 5 Replace logic board. Retain customer's DIMMs.





CD-ROM Drive

CD-ROM drive does not work

- 1 Try using known-good compact disc.
- 2 Replace CD-ROM drive mechanism.

Macintosh does not display CD-ROM icon once CD is inserted in drive

- 1 Verify that CD-ROM software is installed.
- 2 Replace CD-ROM drive mechanism.
- 3 Replace SCSI data cable.
- 4

Computer with 600i CD-ROM drive makes stuttering sounds when playing CD+ or CD-R formatted discs or CD-ROM disc won't mount

Replace CD-ROM drive.





Miscellaneous

No sound from speaker

- 1 Verify that volume setting in Control Panel is 1 or above.
- 2 Clear parameter RAM. Hold down <Command> <Option> <P> <R> during startup but before "Welcome to Macintosh" appears.
- 3 Verify speaker is plugged into logic board.
- 4 Replace speaker.
- 5 Replace logic board. Retain customer's DIMMs.





Errors occur when initializing or erasing floppy disks and/or 1.4 MB disks show only 1 MB available after initialization

This problem only occurs on systems using a 180 MHz or faster processor card. Upgrade to system software version 7.5.4 or later to resolve this problem (the Apple recommended solution) or, alternatively, install the Power Mac Format Patch, which can be found on the original system disks that shipped with the computer. To install the patch:

- While holding down the Option key, drag the Power Mac Format Patch icon onto the System Folder's icon.
- Click OK to automatically place the patch in the Extensions folder.
- Restart the computer by choosing Restart from the Special menu.





Take Apart

Power Macintosh 7300/7500/
7600 & WS 7350





Top Housing

No preliminary steps are required before you begin this procedure.

Note: The top housing covers the top, front, and left and right sides of the computer.





- 1 Press the two tabs at the front corners of the top housing to release the top housing from the bottom chassis.





- 2 Pull the top housing forward about 1 to 2 inches and lift straight up to remove the top housing from the computer.





Bezels

Before you begin, remove the top housing.

Note: As you face the computer, the bezels are in the middle of the top housing's front panel.



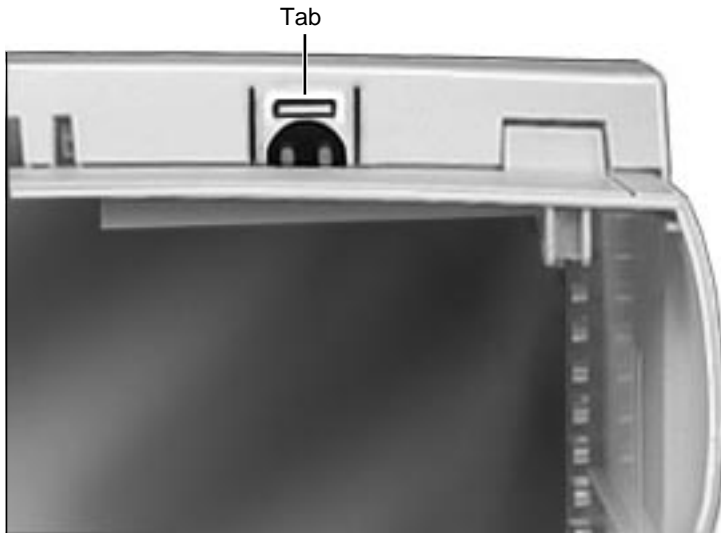

- 1 From the inside of the top housing, push out on the moon-shaped opening at the bottom of the bezel to release the tab. Lift up the bezel to remove it from the top housing.



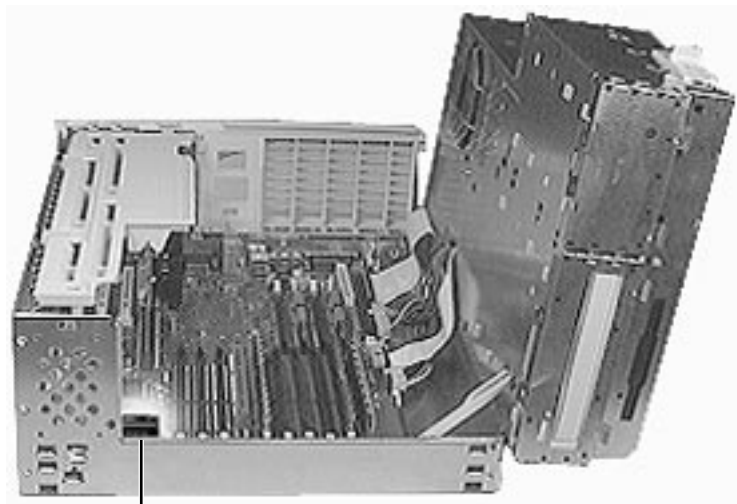

Battery

Battery

Before you begin, remove the top housing.

Note: As you face the computer, the battery is near the front left corner of the logic board.



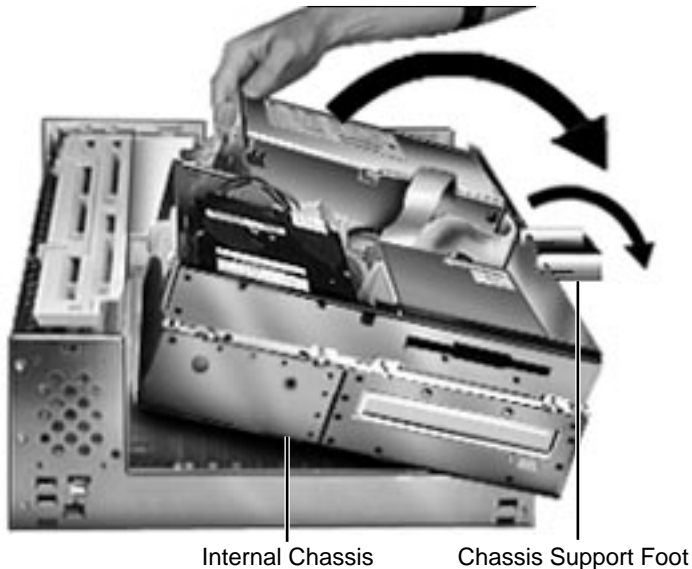

- 1 First, release the chassis latches. Next, flip open the chassis support foot and then swing open the internal chassis that contains the power supply.



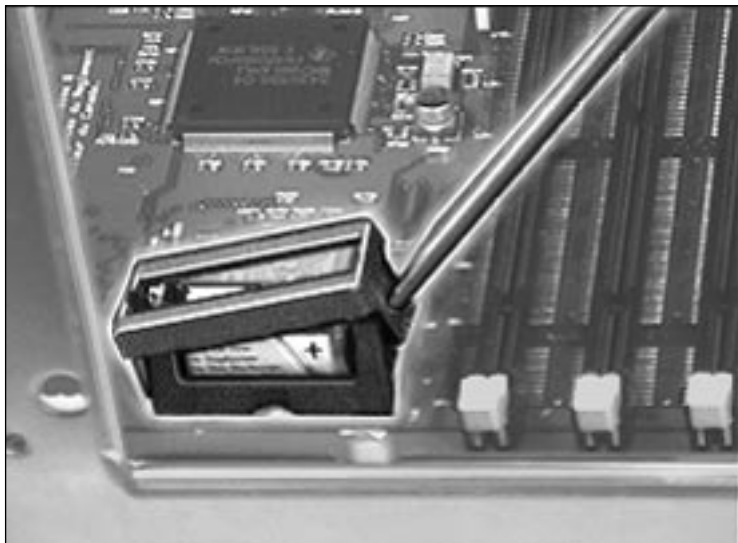

- 2 Use a screwdriver to gently pry up one side of the battery cover.



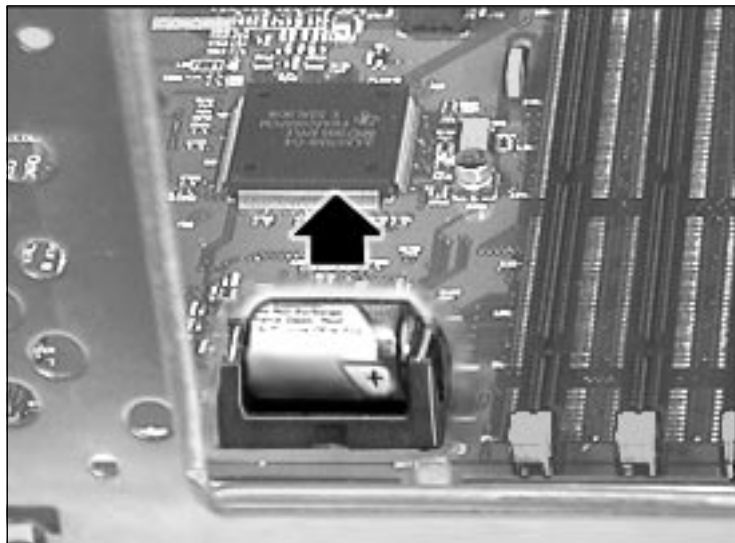

- 3 Lift up the battery to remove it from the logic board.



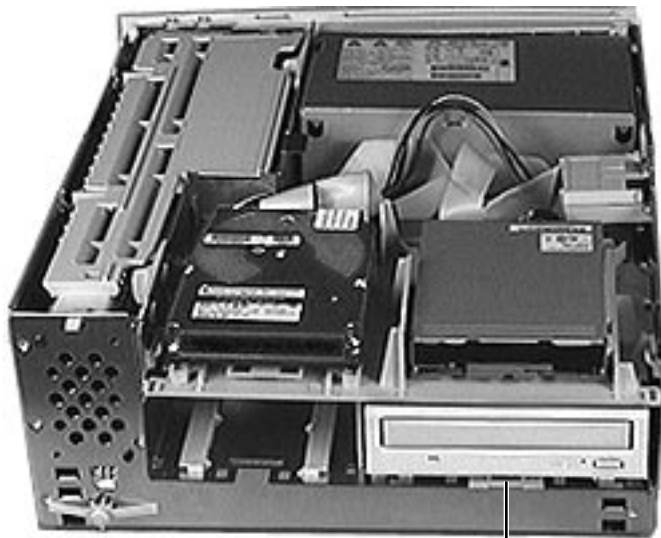

CD-ROM Drive

CD-ROM Drive

Before you begin, remove the top housing.

Note: As you face the computer, the CD-ROM drive is in the bottom right drive bay.



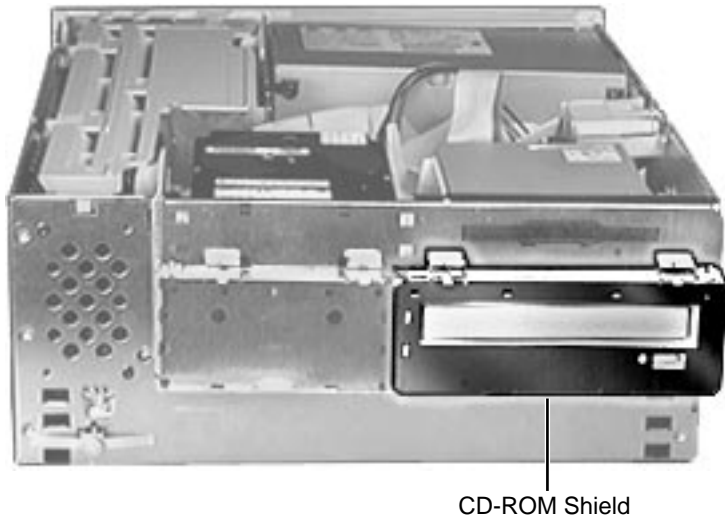

- 1 Lift up the top tabs and pull out the CD-ROM EMI shield to remove it from the front of the CD-ROM drive.





Power Cable

SCSI Cable

CD Audio Cable

- 2 Disconnect the SCSI cable, power cable, and CD audio cable from the back of the CD-ROM drive.



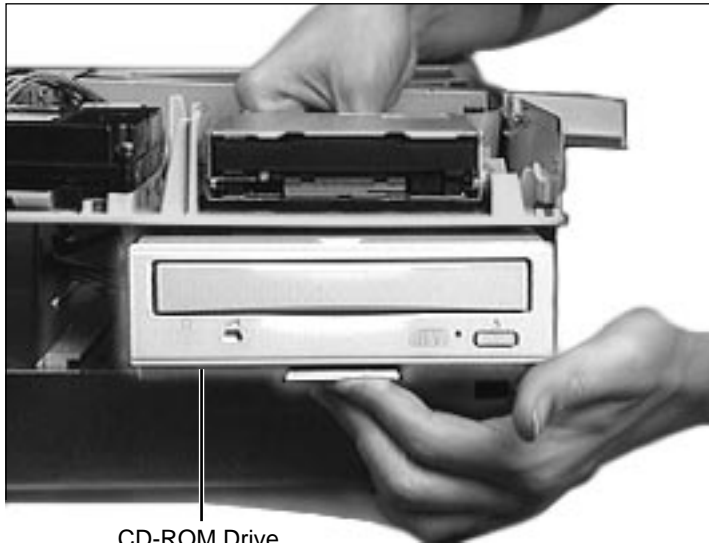

- 3 Pull up the retaining clip (which is located at the back of the CD-ROM drive) and slide the CD-ROM forward to remove it from the internal chassis.

Note: Be sure to remove the CD-ROM drive from its carrier before returning the drive to Apple.





Floppy Drive

Before you begin, remove the top housing.

Note: As you face the computer, the floppy drive is in the top right drive bay.

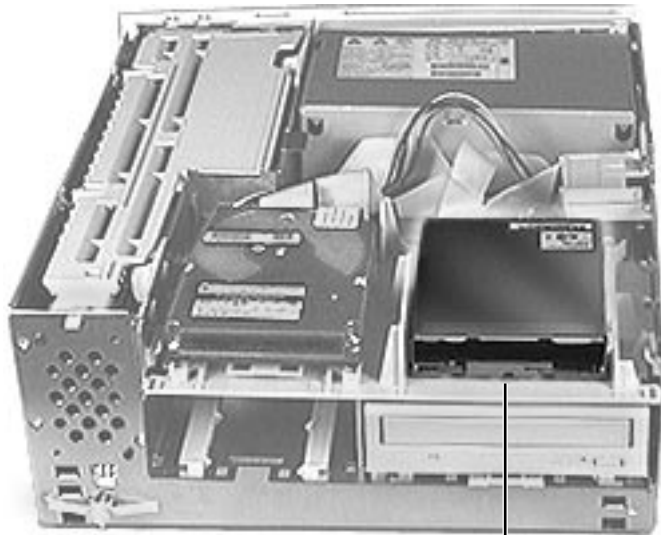

Floppy Drive



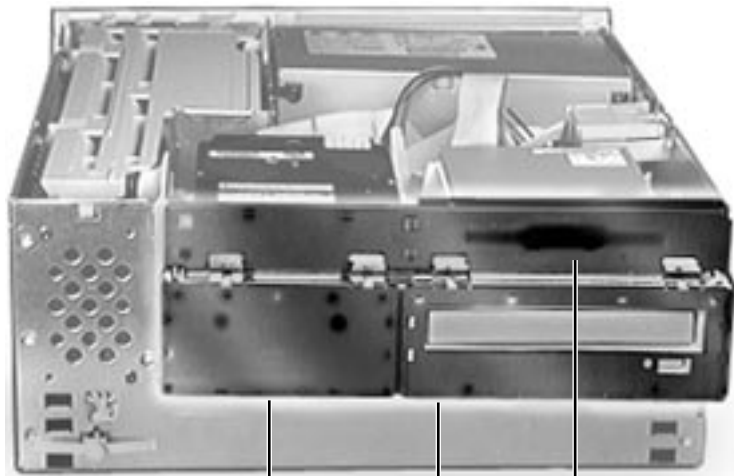

Blank Shield

CD-ROM Shield

Floppy Drive Shield

- 1 Remove the CD-ROM shield, the blank shield, and the floppy drive shield from the front of the unit.





Chassis Support Foot



- 2 Flip open the chassis support foot.





Floppy Drive Cable

Floppy Drive



- 3 Disconnect the floppy drive cable from the back of the floppy drive.



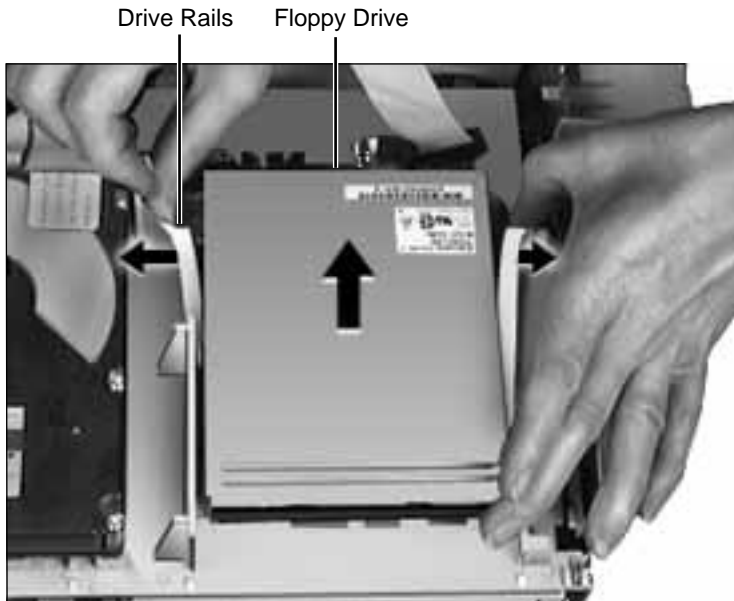

- 4 Pull out on the plastic drive rails that hold the floppy drive to the drive chassis and push back the drive to release it.

Replacement Note: If you are replacing the floppy drive, remove the EMI gasket from the defective drive and attach the gasket in the center of the replacement drive's top surface, with the "V" of the gasket pointing at the front edge of the drive. If the old gasket won't stick, order a new gasket (p/n 922-1895).





Hard Drive

Before you begin, remove the top housing.

Note: As you face the computer, the hard drive is in the top left drive bay.

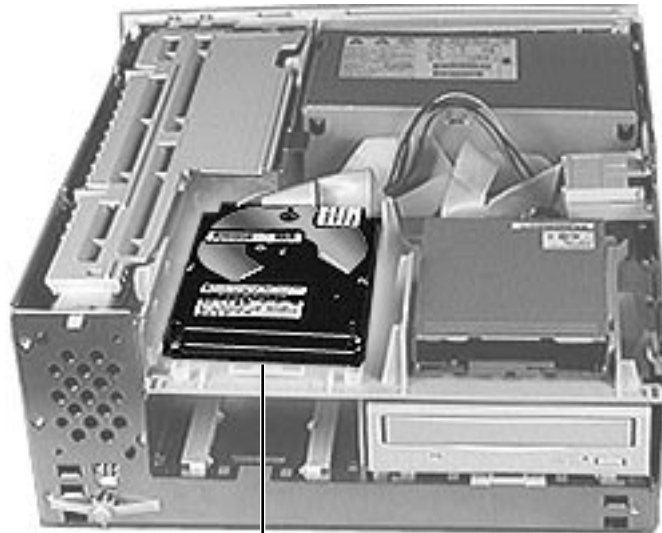

Hard Drive



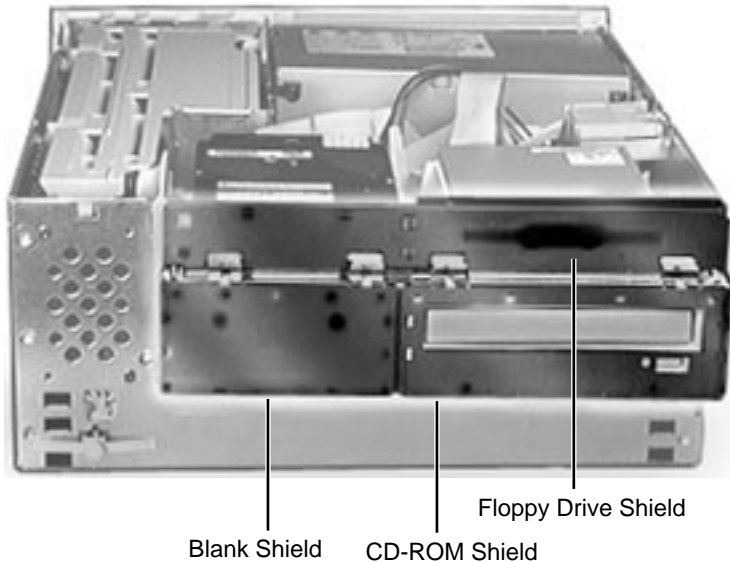

- 1 Remove the CD-ROM shield, the blank shield, and the floppy drive shield from the front of the unit.



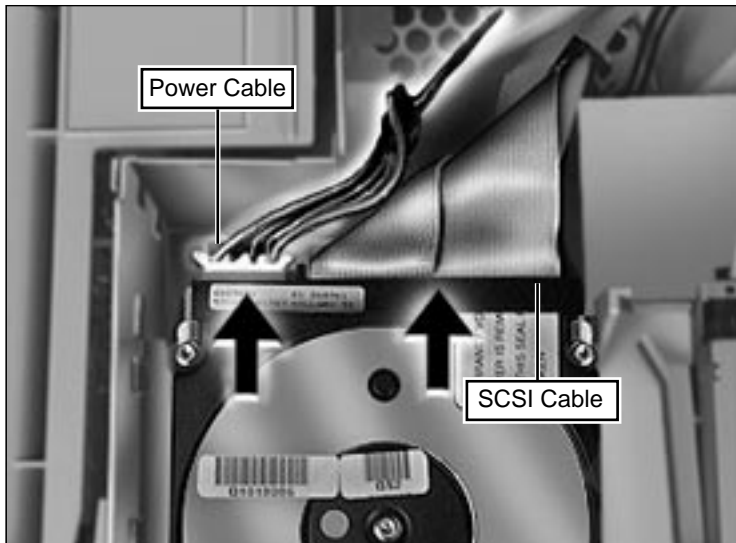

- 2 Disconnect the SCSI cable and hard drive power cable from the back of the hard drive.



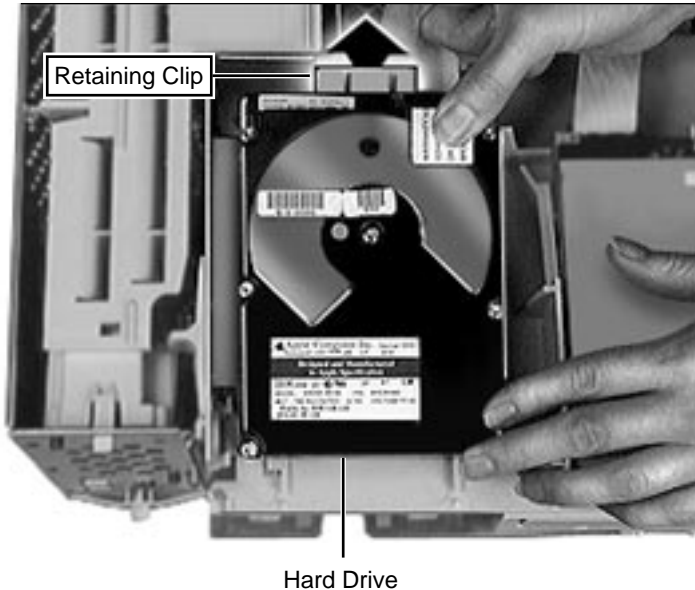

- 3 Pull up the retaining clip at the back of the hard drive and push back the hard drive to remove it from the drive chassis.

Note: For information on removing the hard drive from its carrier and returning drives, cables, and carriers to Apple, refer to Additional Procedures in the Hard Drives manual.





Chassis Latch

Before you begin, remove the top housing.

Note: The chassis latches mount in the internal chassis and secure the internal chassis to the external chassis frame.

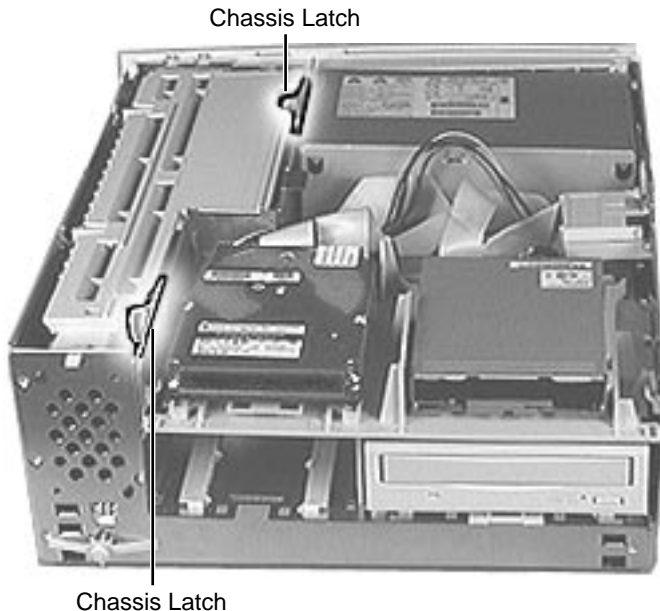

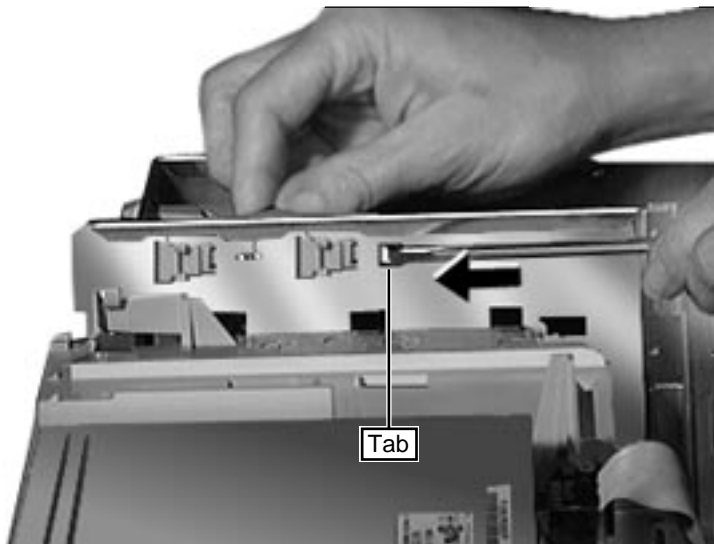

- 1 Use a screwdriver to push out the tab indicated in the illustration. Slide the latch forward and lift it from the chassis.





Drive Rails

Before you begin, remove the following:

- Top Housing
- All Drives

Note: The drive rails attach to the internal chassis underneath the CD-ROM drive and the extra hard drive bay.

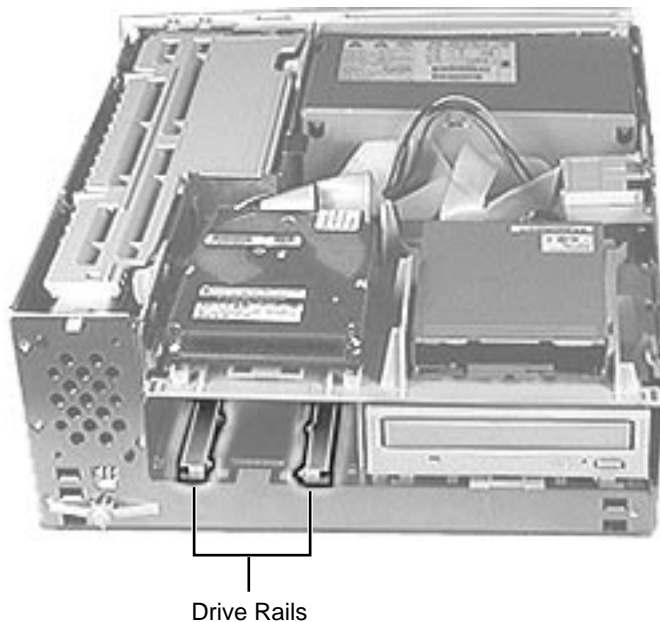

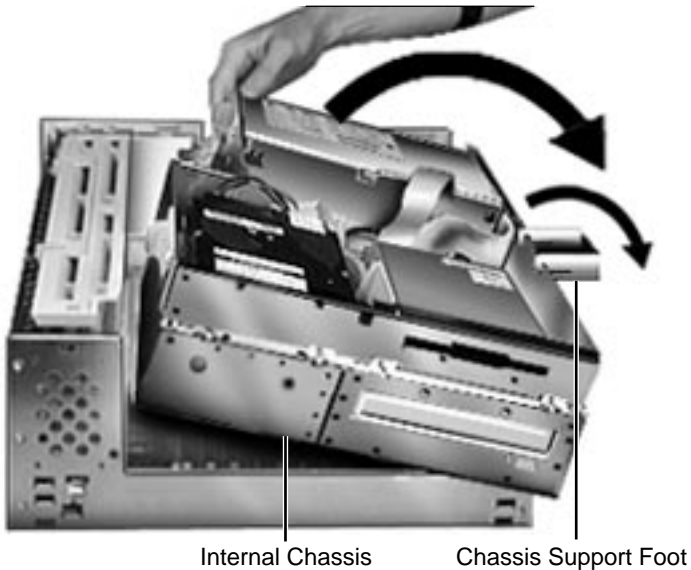

- 1 First, release the chassis latches. Next, flip open the chassis support foot and then swing open the internal chassis that contains the power supply.



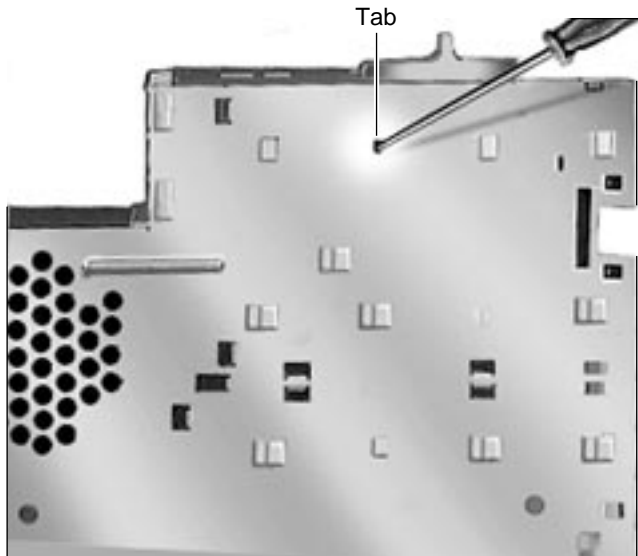

- 2 Use a screwdriver to push out the tab indicated in the illustration.
- 3 Slide the drive rail either forward or backward (depending on which way the tabs are facing) and lift it from the chassis.



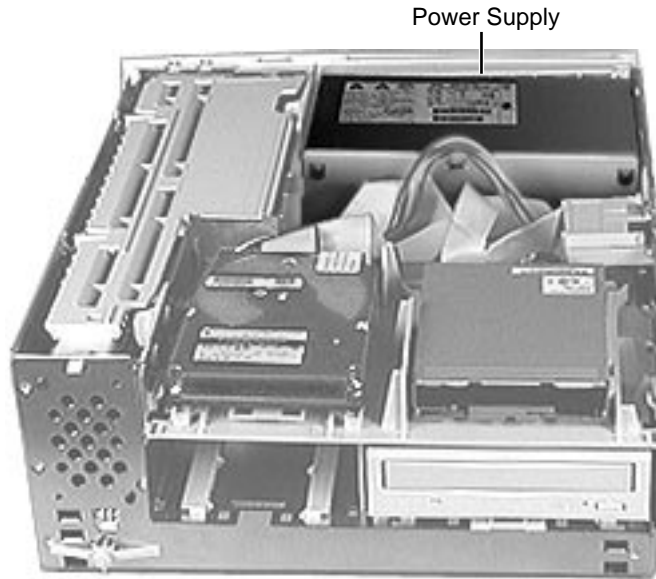

Power Supply

Before you begin, remove the top housing.

Note: As you face the computer, the power supply is in the back right corner.

IMPORTANT: When replacing the power supply, be sure the voltage switch on the back of the power supply is set correctly (115V in the U.S.).



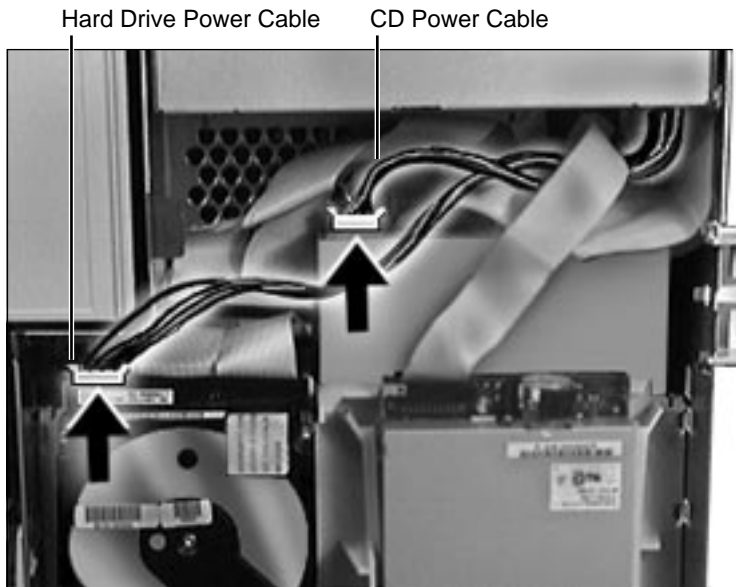

- 1 Disconnect the power supply cables from the back of the CD-ROM drive and hard drive(s).



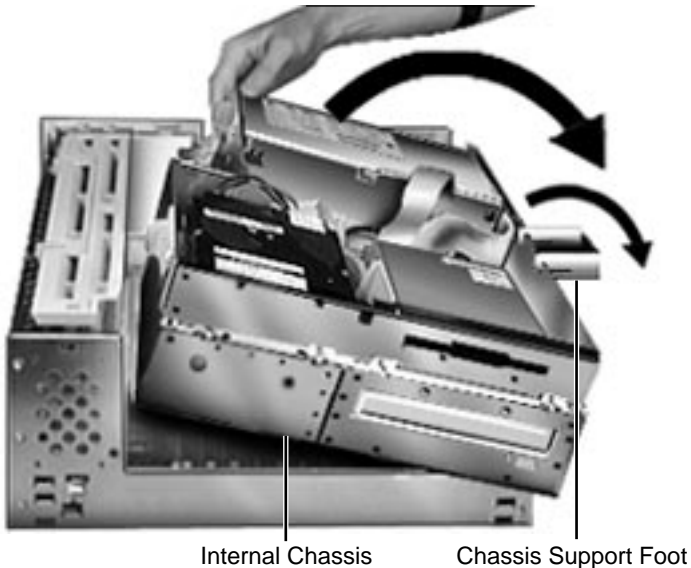

- 2 First, release the chassis latches. Next, flip open the chassis support foot and then swing open the internal chassis that contains the power supply.



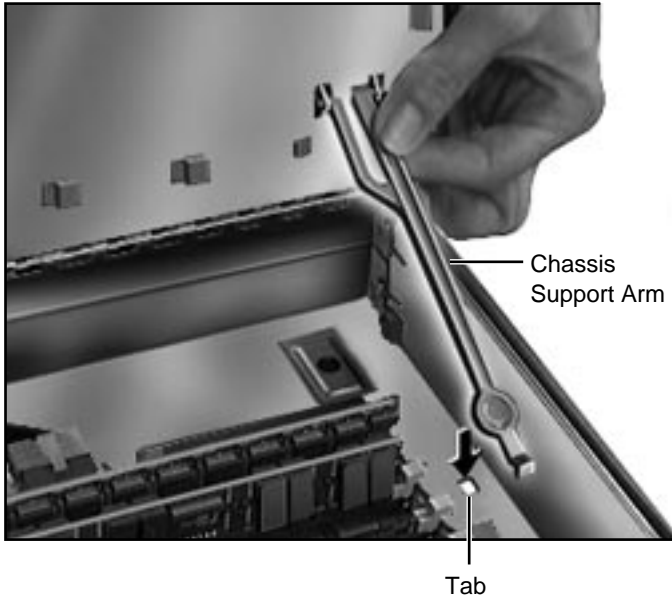

- 3 To secure the internal chassis in the up position, flip down the chassis support arm. Make sure the tab on the bottom of the support arm is securely fastened in the hole provided in the bottom chassis.

Warning: To be safe, never work on the computer with the internal chassis in the up position unless the chassis support arm is down and securely fastened.





Power Supply Cables

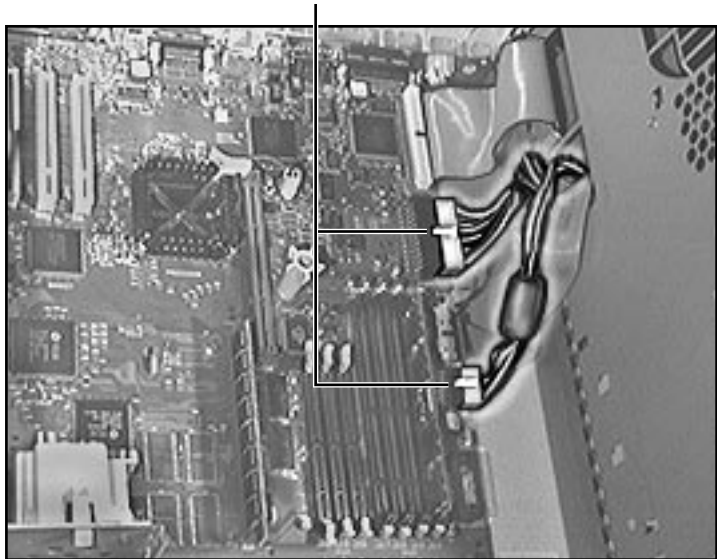

- 4 Disconnect the power supply cables from the logic board.

Note: The 10-pin power supply cable supplies 3.3 V power for the processor card. The 22-pin cable supplies 5 V and +/- 12 V power for the logic board.



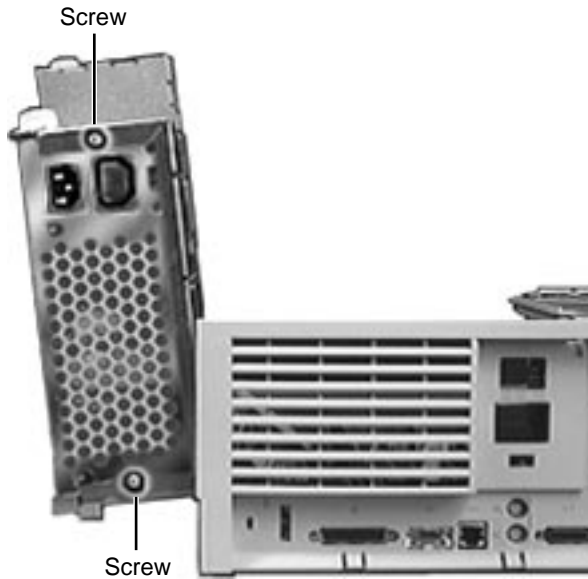

- 5 From the back of the computer, remove the two screws that secure the power supply to the chassis.



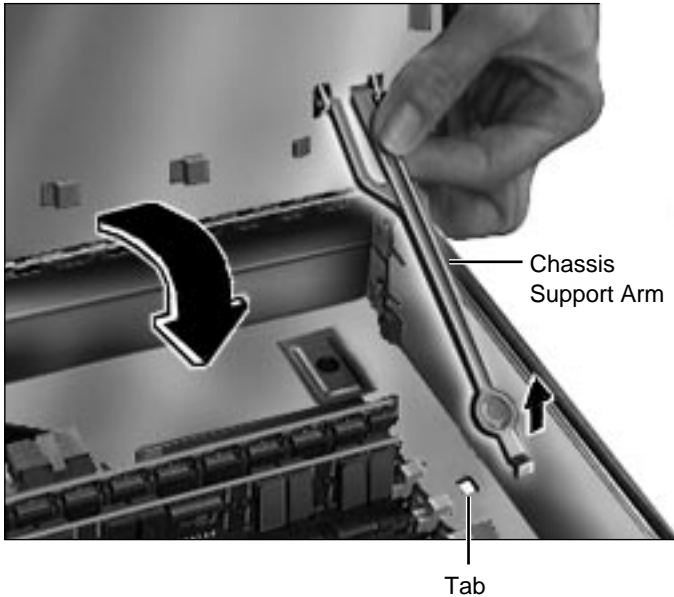

- 6 Release the chassis support arm and swing down the internal chassis.





- 7 Slide the power supply forward and pull it out of the computer. You will need to feed the power supply cables that connect to the logic board up through the hole in the chassis.

IMPORTANT: Make sure the power supply switch on the back of the power supply is set to the correct voltage (115V in the U.S.) The switch is accessible through the computer's rear panel when the power supply is installed.





Replacement Note: There are two metal tabs on the back of the metal chassis that lock into the power supply. When replacing the power supply, slide it back until it locks into place.



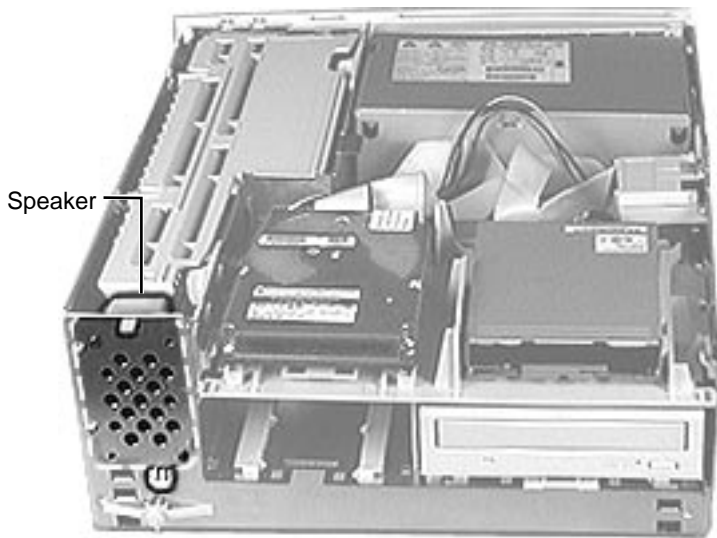

Speaker

Before you begin, remove the top housing.

Note: As you face the computer, the speaker is in the front left corner of the bottom chassis.



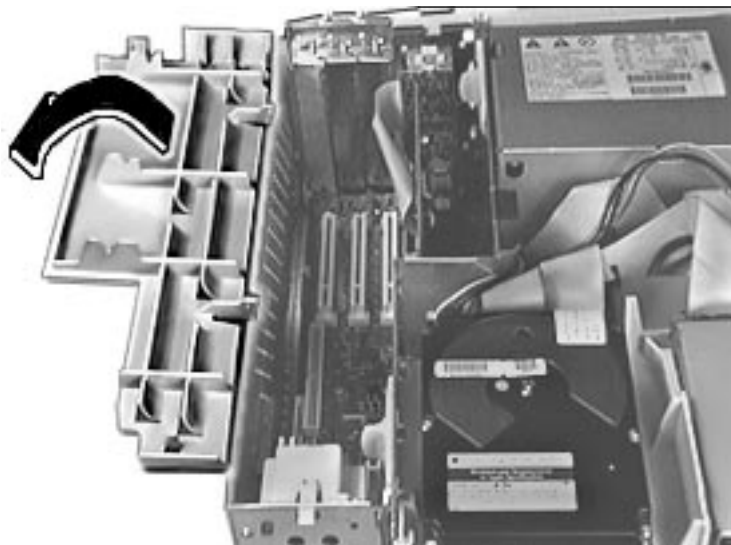

- 1 Swing open the expansion card cover.



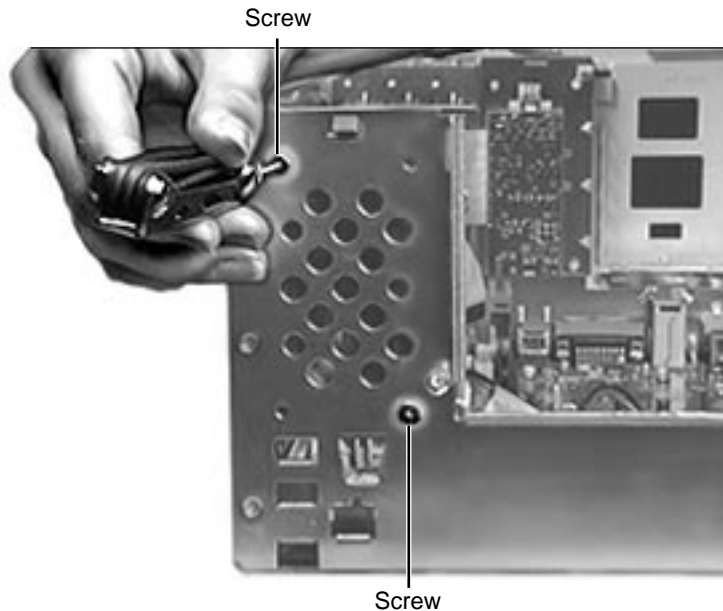

- 2 Remove the two Torx screws that secure the speaker to the metal chassis.



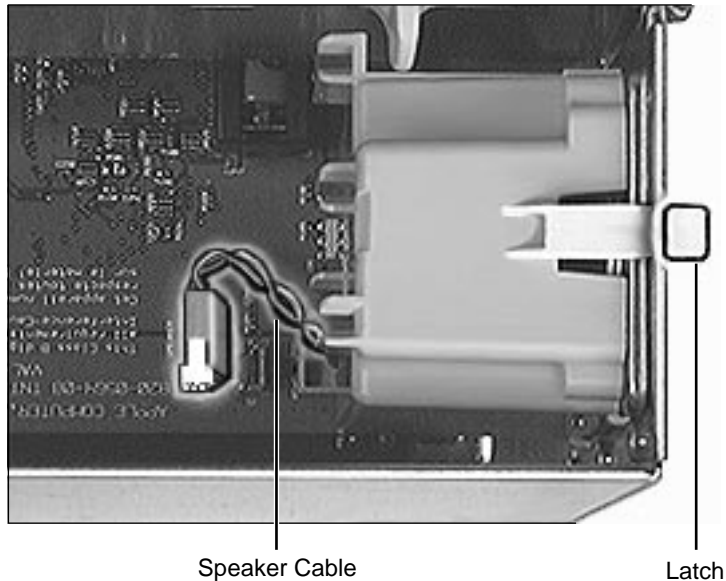

- 3 Disconnect the speaker cable from the logic board.
- 4 Press the latch holding the speaker to the chassis and lift the speaker out of the computer.





Power Actuator

Before you begin, remove the top housing.

Note: As you face the computer, the power actuator is in the front left corner of the bottom chassis (directly beneath the speaker).

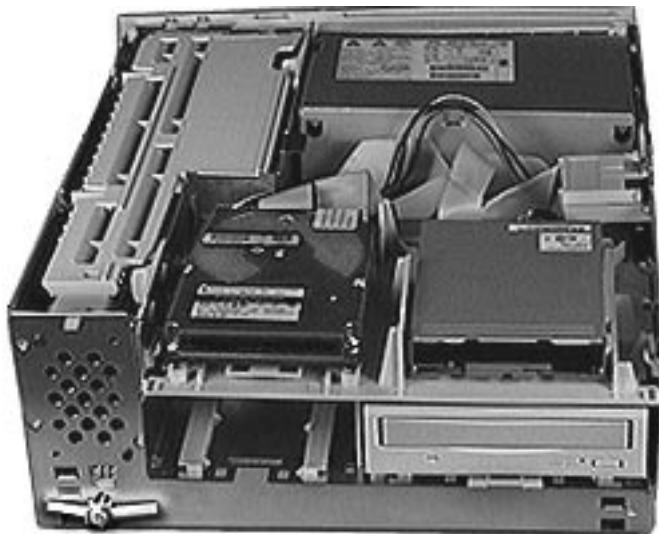

Power Actuator



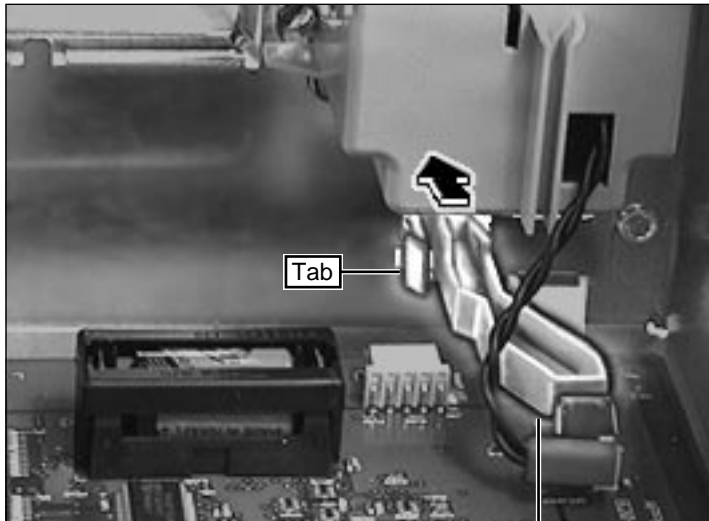

- 1 Push in the tab that secures the power actuator to the chassis and push the power actuator out of the computer.





PCI Cover

Before you begin, remove the top housing.

Note: As you face the back of the computer, the PCI covers are on the right side of the rear panel.



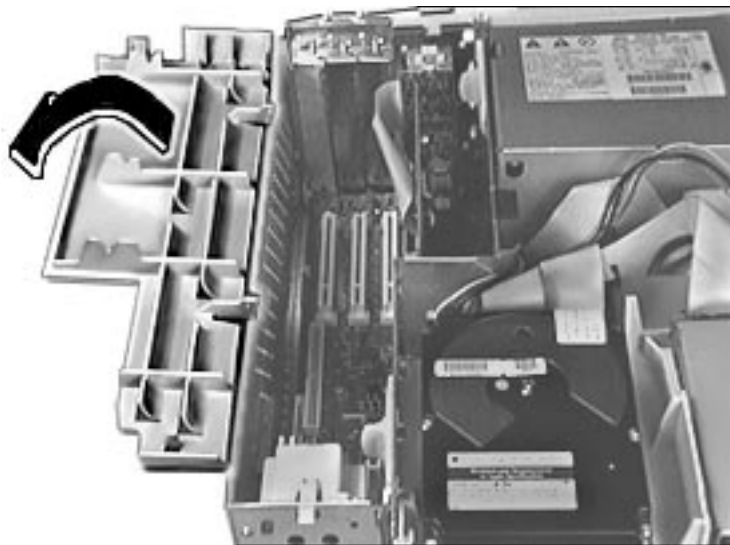

- 1 Swing open the expansion card cover.



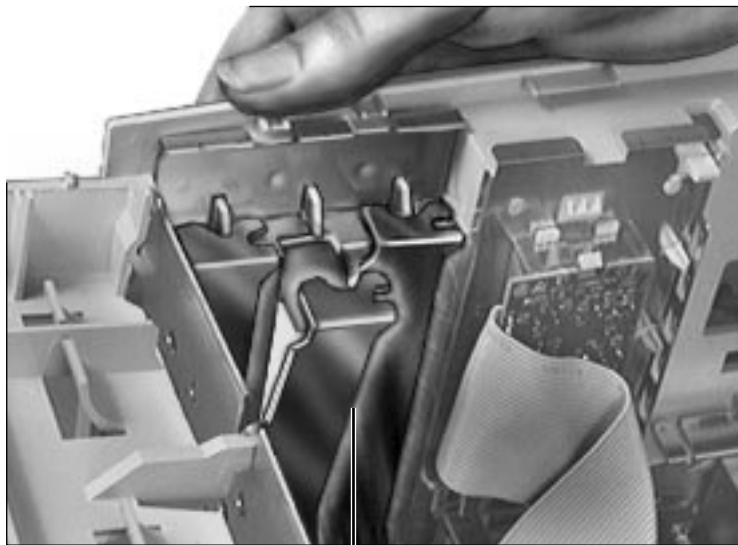

PCI Cover

- 2 From the back of the computer, press in and lift up on the PCI cover to remove it.



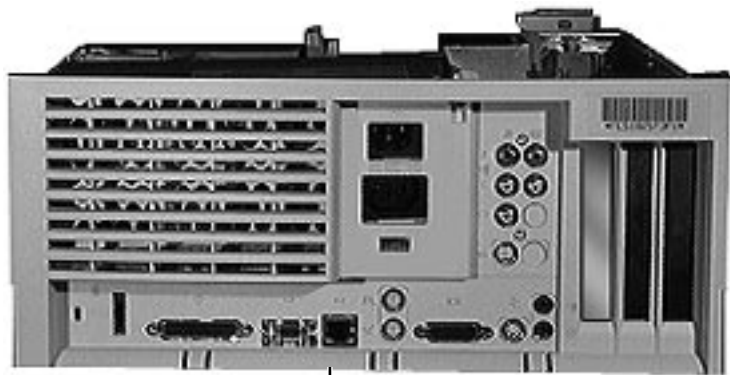

Rear Panel

Rear Panel

Before you begin, remove the top housing.

Note: The rear panel covers the back side of the computer through which all the external connectors are accessible.



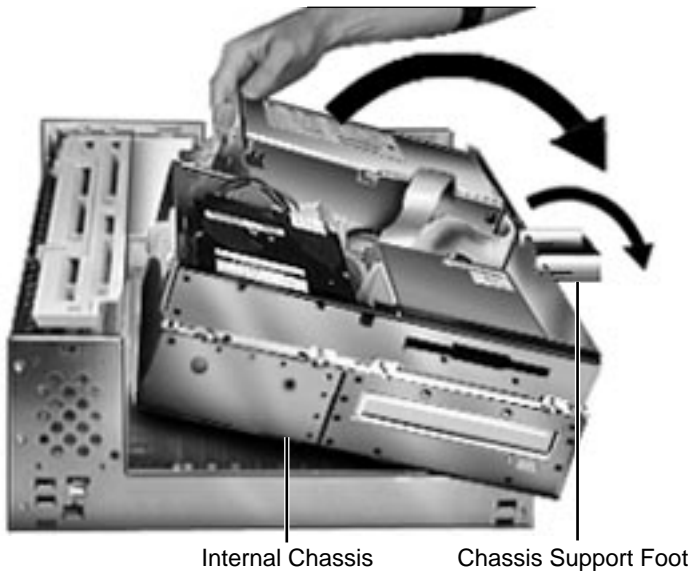

- 1 First, release the chassis latches. Next, flip open the chassis support foot and then swing open the internal chassis that contains the power supply.



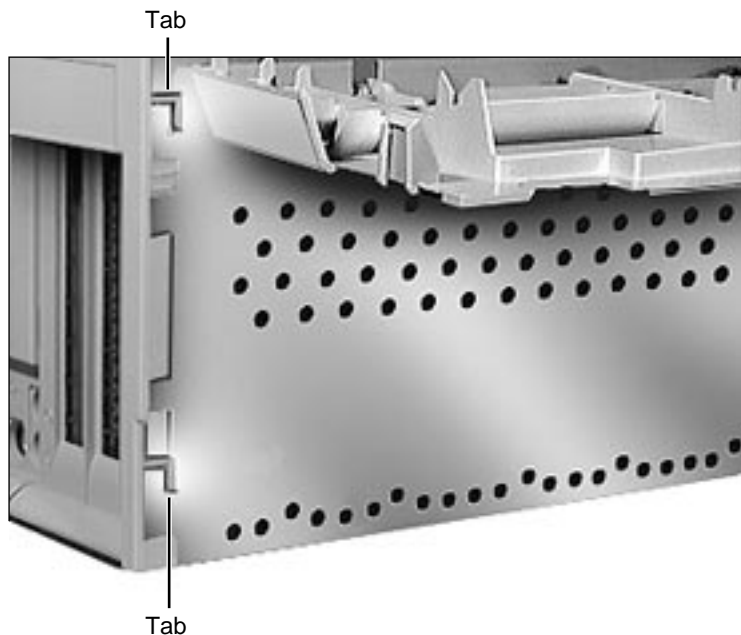

- 2 Lift the rear panel straight up to unhook it from the metal chassis. Once the rear panel is unhooked, you can remove it from the computer.

Note: There are tabs on the rear panel that hook into the metal chassis.





Replacement Note: To replace the rear panel, you must first follow the procedures for removing the logic board. Instead of fully removing the logic board from the chassis, however, just slide it forward about an inch. Once you have the rear panel in place, slide the logic board back toward the rear panel until the board locks into place. Be sure the logic board connectors are lined up properly with the openings in the rear panel.





Processor Card

Before you begin, remove the top housing.

Note: The processor card installs perpendicularly to the logic board directly beneath the plastic PCI guide.

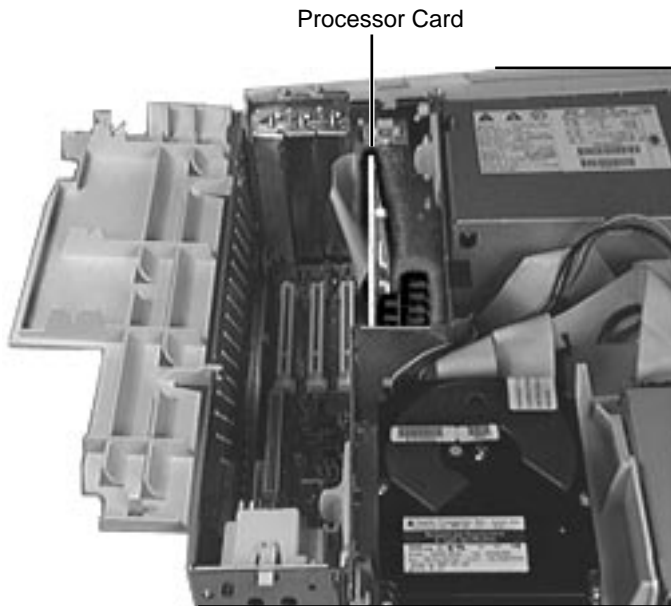

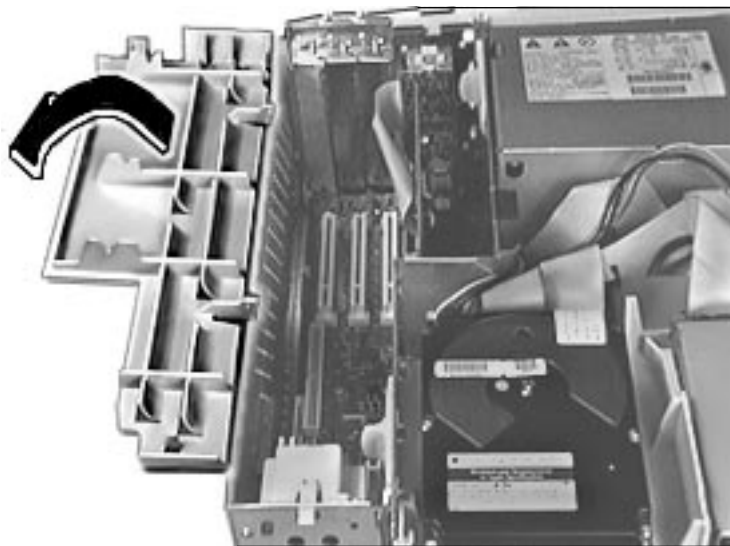

- 1 Swing open the expansion card cover.



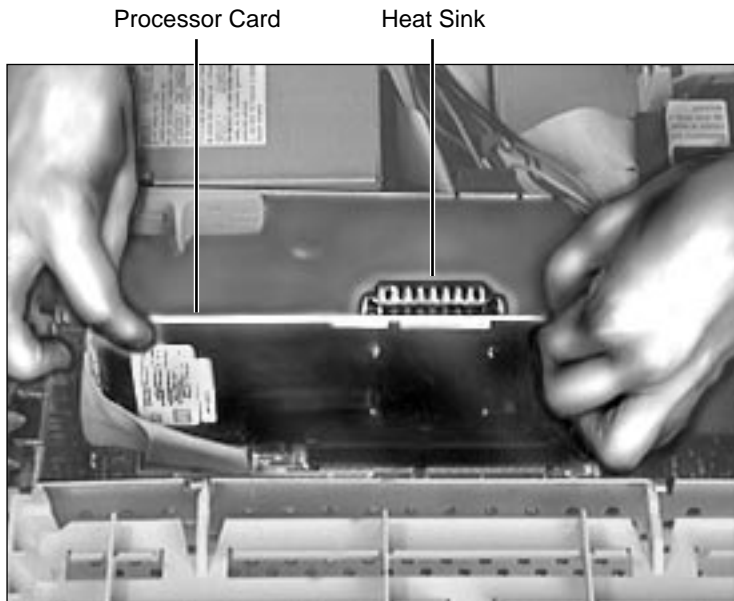

Warning: The heat sink may be hot to the touch.

- 2 Grab the corners of the processor card and pull the card straight up to remove it.

Replacement Note: Position the card evenly over the processor card slot and press down gently. Do not force the card or you may damage it. Make sure the card is seated evenly.

If you are installing a 132 MHz card in the computer, you must install an EMI clip.



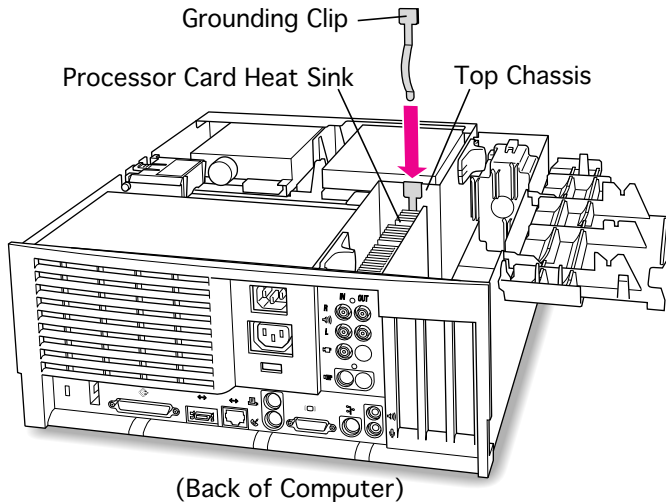

The EMI clip is provided in the 132 MHz Card Upgrade Kit.

- 3 Slide the grounding EMI clip over one wall of the top chassis. Make sure the grounding clip also touches the processor card heat sink.



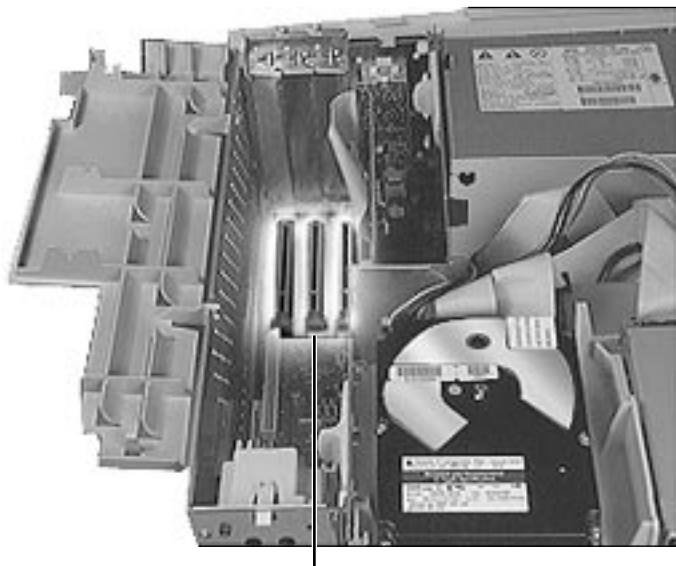

PCI Card Slots

PCI Cards

Before you begin, remove the top housing.

Note: PCI expansion cards, if present, install perpendicularly to the logic board in one of three PCI slots. They are located directly beneath the plastic PCI guide.

If installing third-party PCI cards, use the middle PCI slot for better clearance with the expansion card cover. If necessary, remove the expansion cover.



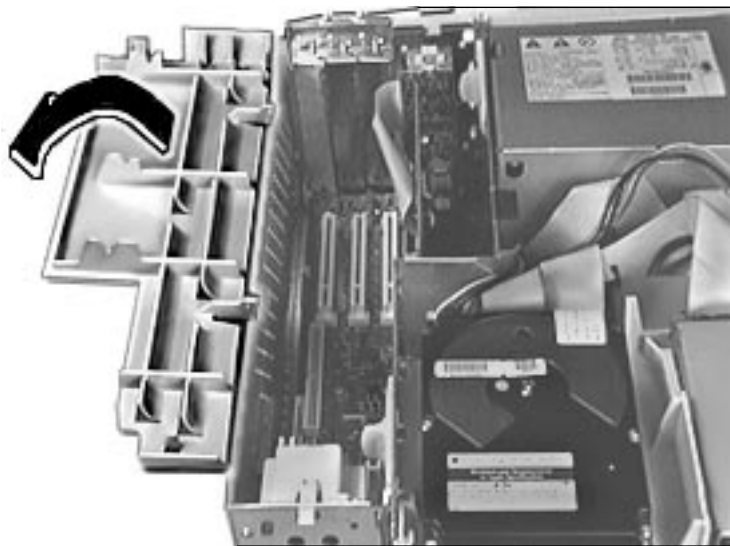

- 1 Swing open the expansion card cover to provide access to the logic board.



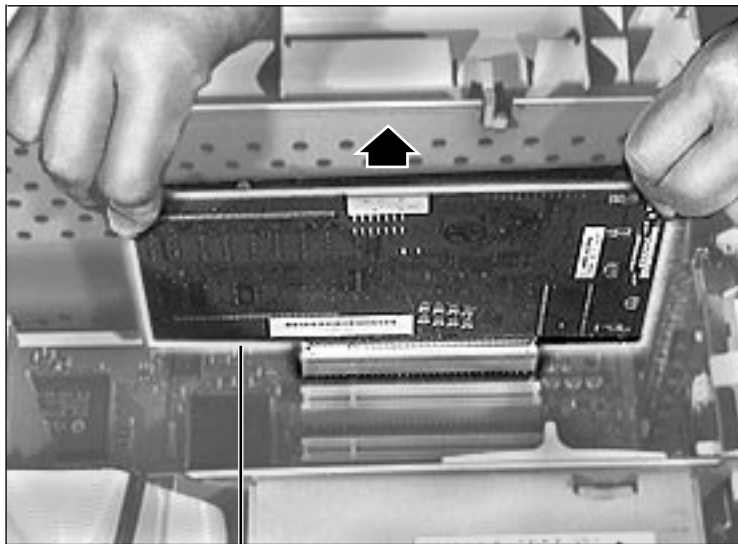

PCI Card

- 2 Grab the corners of the PCI card and pull up the card to remove it.



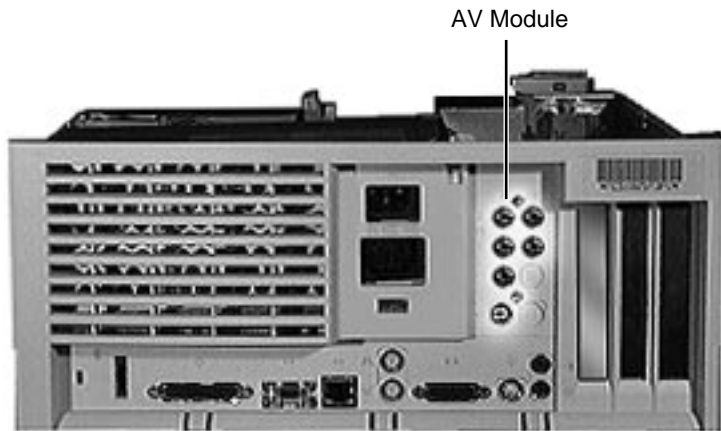

AV Module

Before you begin, remove the top housing.

Note: The AV module is installed only in Power Macintosh 7500 and 7600 Series computers. The module attaches to the rear panel and plugs into the logic board. It's located next to the PCI slots.



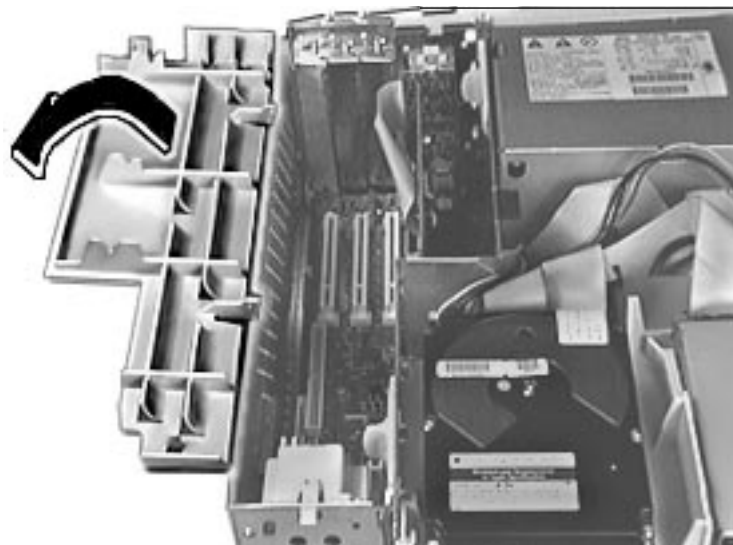

- 1 Swing open the expansion card cover to provide access to the AV module.





AV Module Cable

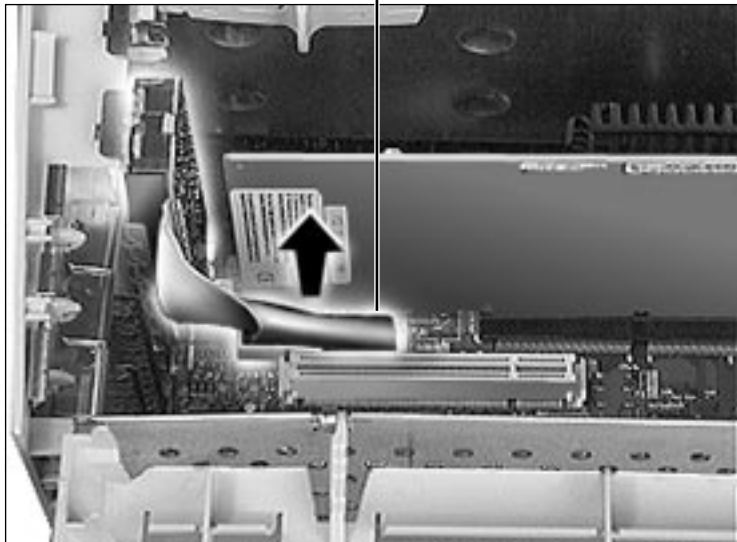

- 2 Disconnect the AV module cable from the logic board.



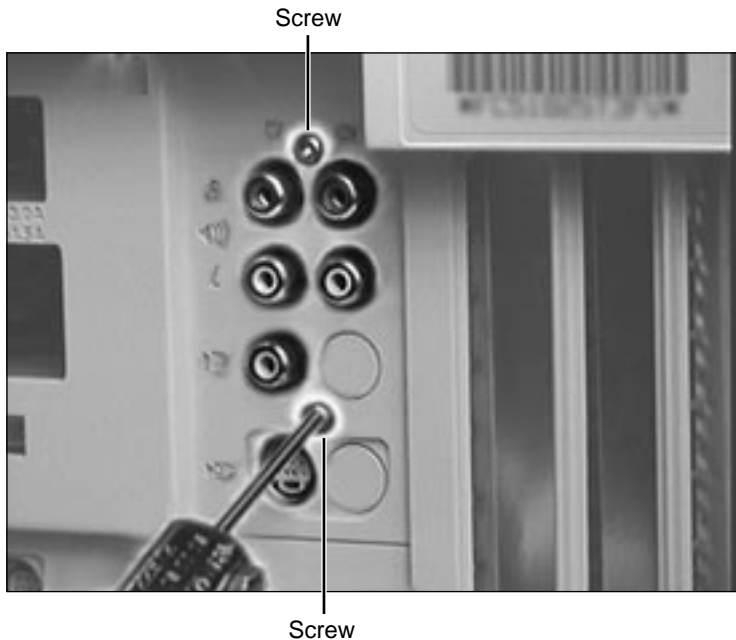

- 3 Remove the two Torx screws that secure the AV module to the rear panel.



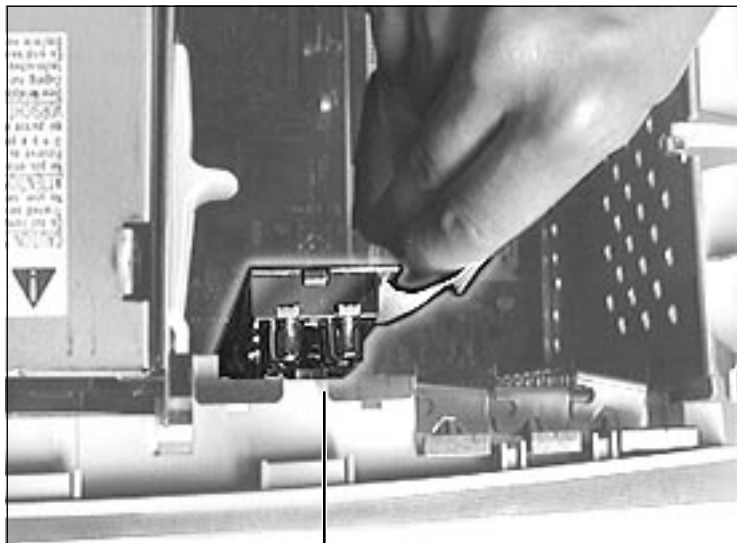

AV Module

- 4 Lift out the AV module to remove it from the computer.



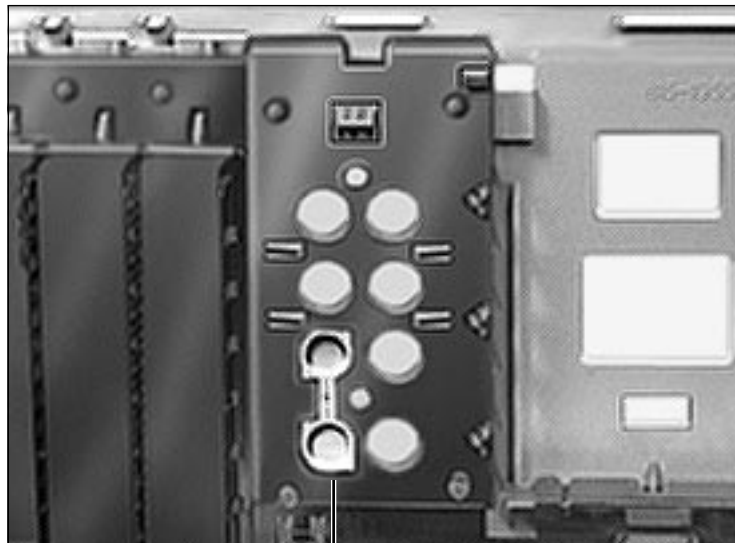

AV Connector Cover

- 5 Remove the AV connector cover from the rear panel.



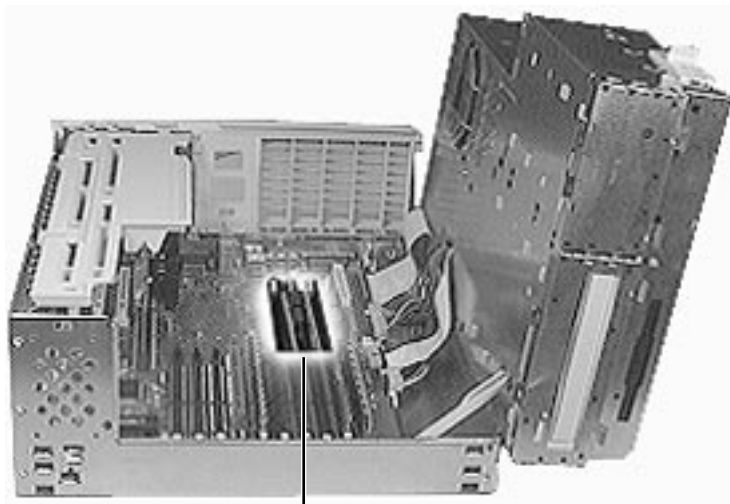

VRAM DIMM Slots

VRAM DIMMs

Before you begin, remove the top housing.

Note: VRAM DIMMs install on the logic board in the VRAM DIMM slots.

Note: The Power Macintosh 7300, 7500, and 7600, and WS 7350 computers use VRAM DIMMs (112-pin, 70 ns or faster) instead of VRAM SIMMs. The VRAM SIMMs used in earlier Power Macintosh models are not compatible.



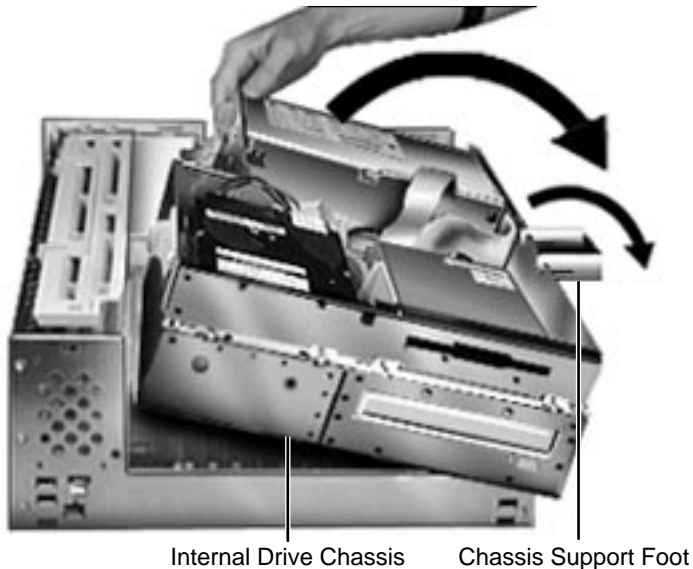

- 1 First, release the chassis latches. Next, flip open the chassis support foot and then swing open the internal chassis that contains the power supply.



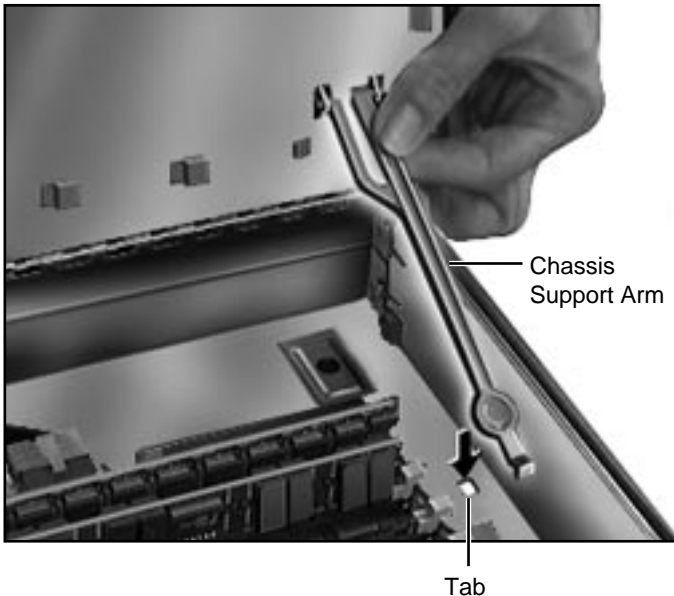

- 2 To secure the internal chassis in the up position, flip down the chassis support arm and make sure its bottom tab is securely fastened in the hole provided in the bottom chassis.

Warning: To be safe, never work on the computer with the internal chassis in the up position unless the chassis support arm is down and securely fastened.



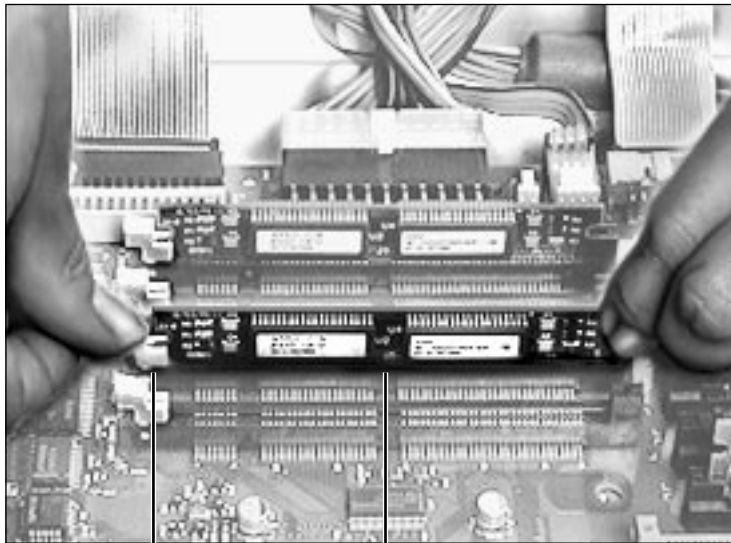

Release Latch

VRAM DIMM

- 3 Push down the release latch next to the VRAM DIMM. Grab the DIMM by the top corners and lift straight up to remove the DIMM from the logic board.

Note: See the following pages for important replacement information.





Replacement Note: Position the DIMM evenly over the slot and press down gently to install it. The release latch should click into place. Be careful not to force the VRAM DIMM or you may damage it. Make sure the DIMM is evenly seated.

Note: This computer uses VRAM DIMMs (112-pin, 70 ns or faster) instead of VRAM SIMMs. The VRAM SIMMs used in earlier Power Macintosh models are not compatible.

Note: The Power Macintosh 7300, 7500, and 7600 and WS 7350 computers come with two 1 MB VRAM DIMMs installed. To upgrade the unit to 4 MB, you must install two 1 MB VRAM DIMMs in the remaining VRAM slots. VRAM DIMMs must be installed in matching pairs and in paired slots in the computer.



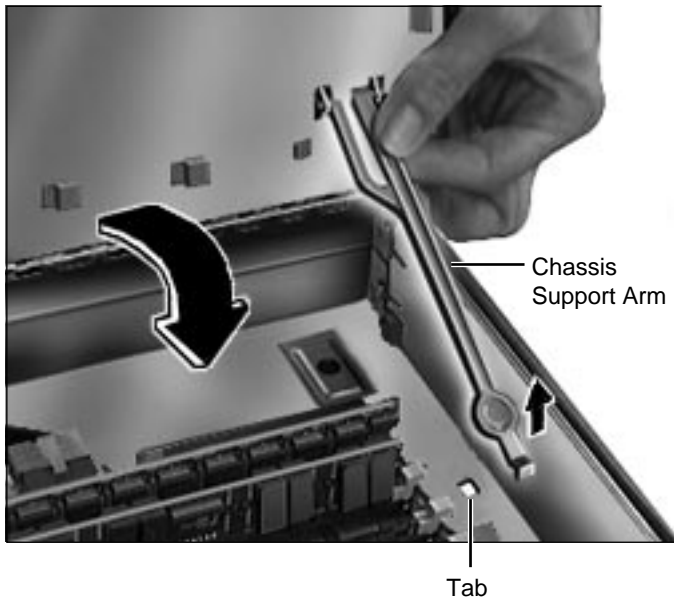

- 4 Be sure to release the chassis support arm before you swing down the internal chassis.



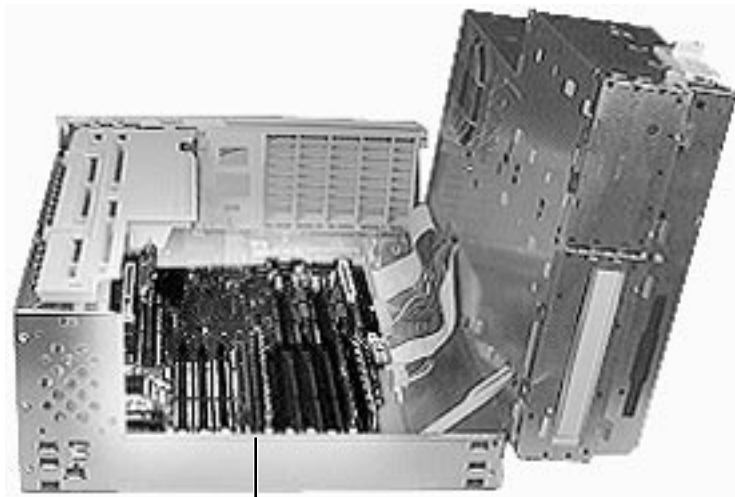

Logic Board

Logic Board

Before you begin, remove the following:

- Top Housing
- Processor Card
- PCI Cards (if present)
- Speaker
- Power Actuator

Note: The logic board is located in the very bottom of the bottom chassis.



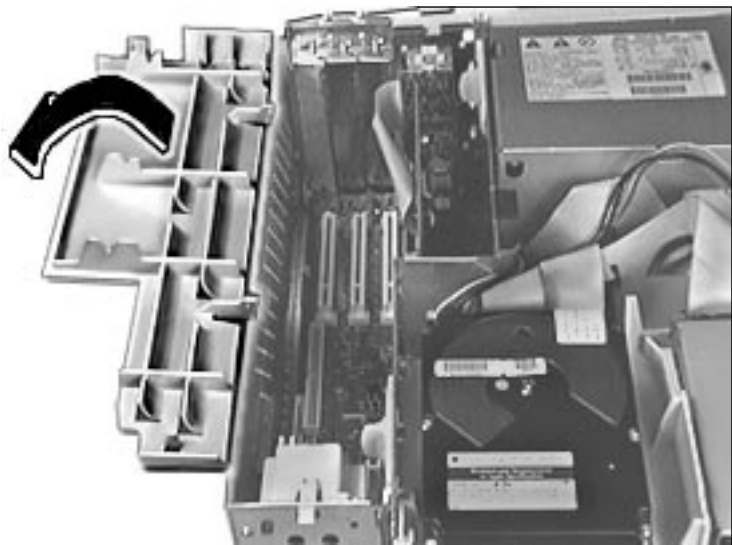

- 1 Swing open the expansion card cover to provide access to the logic board.





- 2 First, release the chassis latches. Next, flip open the chassis support foot and then swing open the internal chassis that contains the power supply.

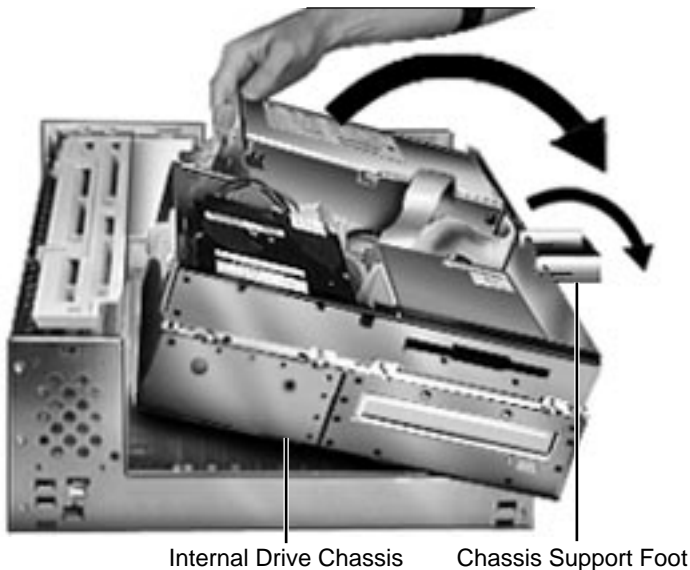

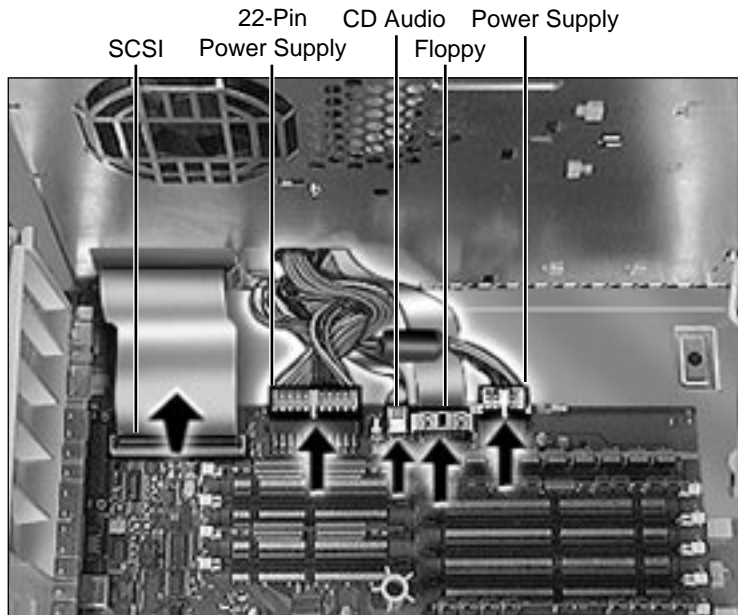

- 3 Disconnect the following cables from the logic board: both power supply cables, floppy drive cable, SCSI cable, and CD audio cable.



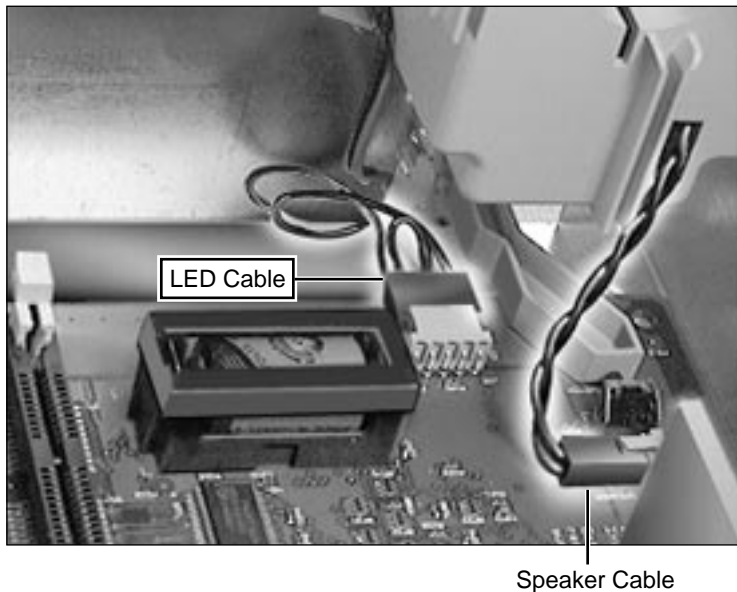

- 4 Disconnect the LED and speaker cables from the logic board.





AV Module Cable

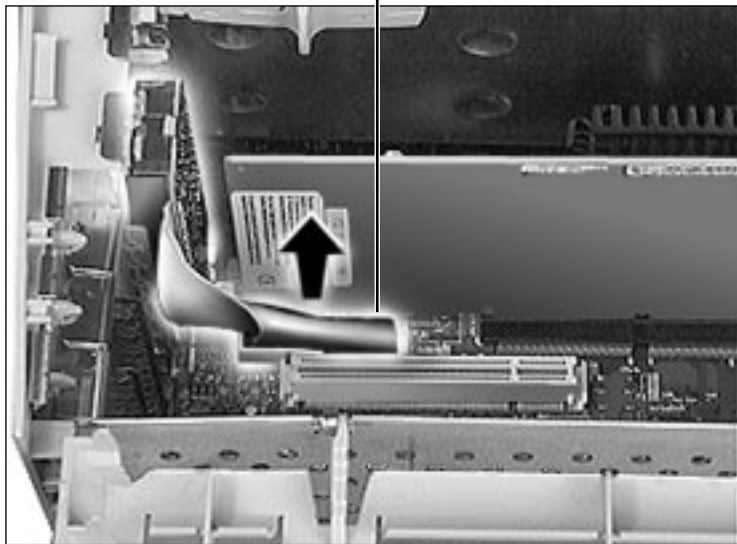

- 5 Disconnect the AV module cable from the logic board.



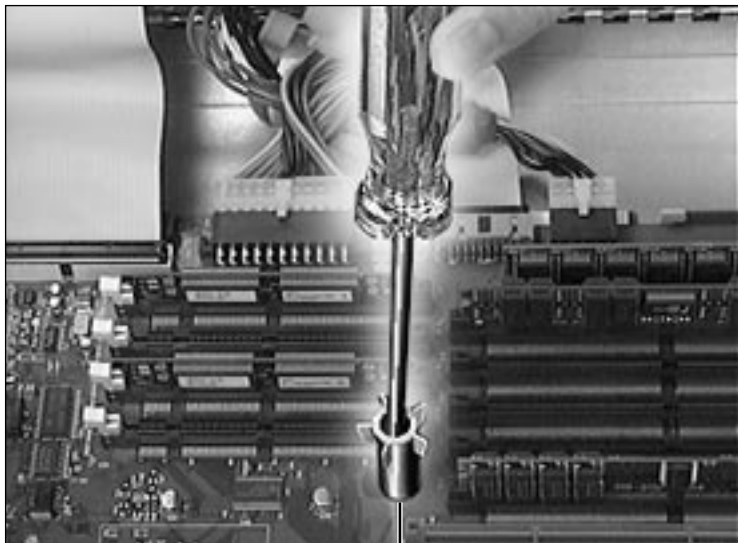

Top Column Support

- 6 Remove the screw inside the top column support that secures the logic board to the chassis.



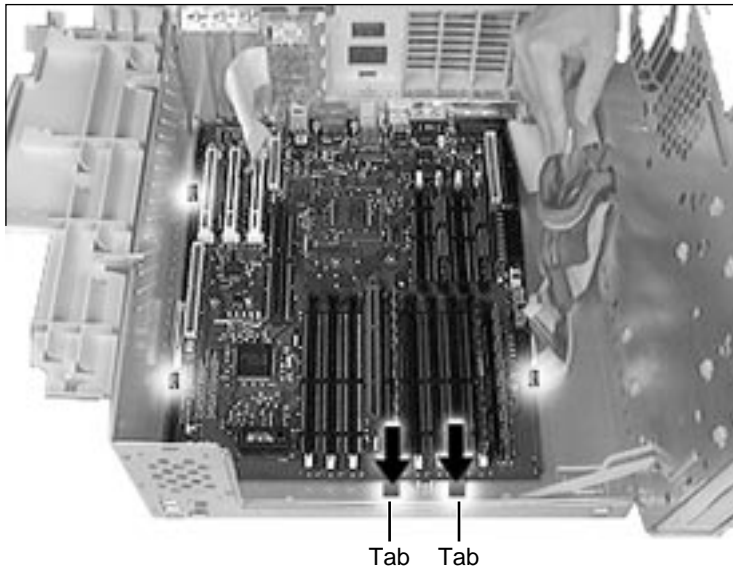

- 7 Press down on the two tabs at the front of the logic board and slide the logic forward (away from the rear panel) to release it from the tabs on the bottom chassis. Lift the logic board from the chassis to remove it.

IMPORTANT: Remove the EMI clip when you take the logic board out of the chassis. Failure to comply may result in damage to the board. (See the next page for instructions).



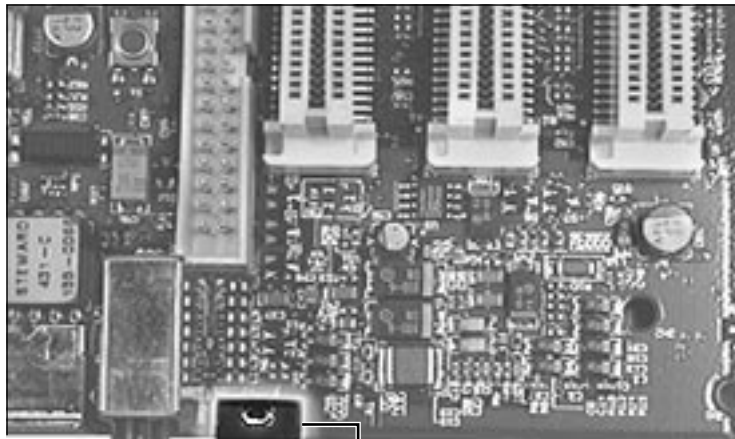

EMI Clip

- 8 Lift up the top edge of the EMI clip and pull it off the board to remove it.

Note: Remove the EMI clip and any cache, DRAM, or VRAM DIMM(s) before returning the logic board to Apple. Do NOT remove the ROM SIMM (if present).





Bottom Chassis

Before you begin, remove the following:

- Top Housing
- Processor Card
- PCI Cards (if present)
- AV Module (if present)
- Speaker
- Power Supply
- Power Actuator
- All Drives
- Chassis Latches
- Drive Rails
- Logic Board
- Rear Panel

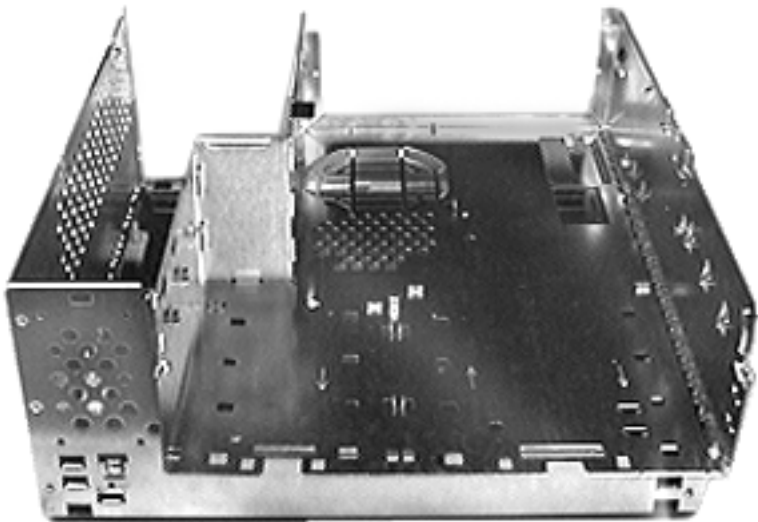

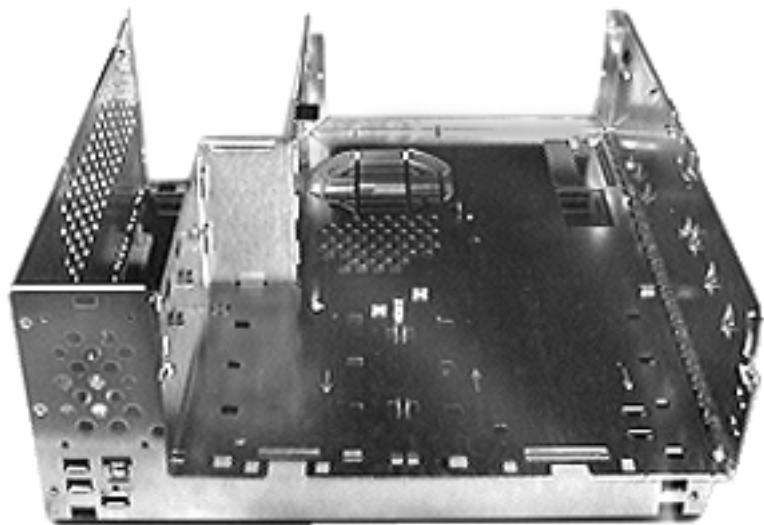

Note: The bottom chassis is what is left once all other modules have been removed.





Security Bar

No preliminary steps are required before you begin this procedure.

Note: The security bar is a feature on the Power Macintosh 7300 Series, the Power Macintosh 7600/200, and the WS 7350 computers.



Security Bar



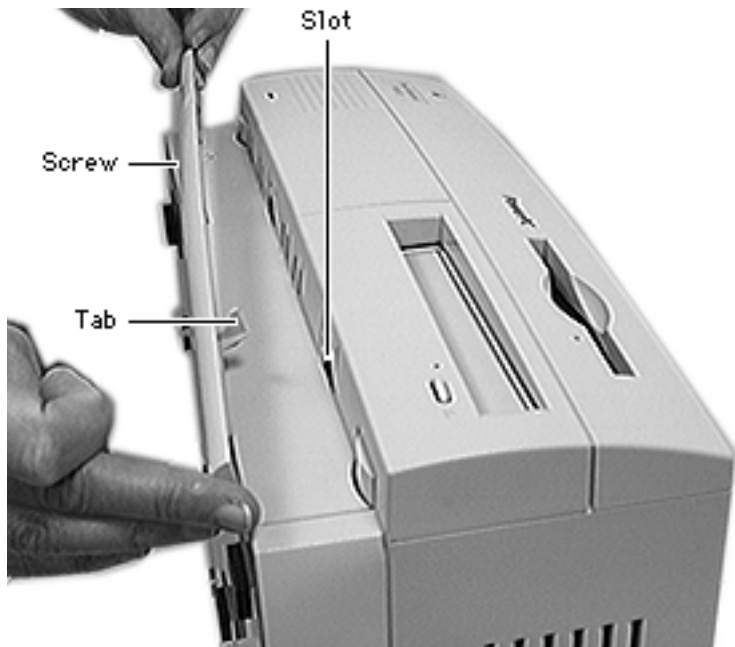

- 1 Remove the security bar mounting screw.
- 2 Rotate the bar up to release the tab from the slot on the front of the computer and remove the bar.





Upgrades

Power Macintosh 7300/7500/
7600





PC Compatibility Cards

There are three Apple PC Compatibility cards that can be installed in the Power Macintosh 7300, 7500, and 7600 Series computers:

- 7" 100 MHz PC Compatibility Card
- 12" 100 MHz PC Compatibility Card
- 12" 166 MHz-P PC Compatibility Card

For more information about these cards and installation instructions, refer to the PC Compatibility Card manual on this Service Source CD.





Power Macintosh 7600 Upgrade

The Power Macintosh 7600 Upgrade Kit upgrades a Power Macintosh 7200 to a 7600. The upgraded logic board does not include a processor on the board; it requires that you install a separate processor card to run the machine.

Refer to the Upgrades Chapter in the Power Macintosh 7200 Series/WS 7250 manual for complete installation instructions.





Exploded View

Power Macintosh 7300/7500/
7600 & WS 7350



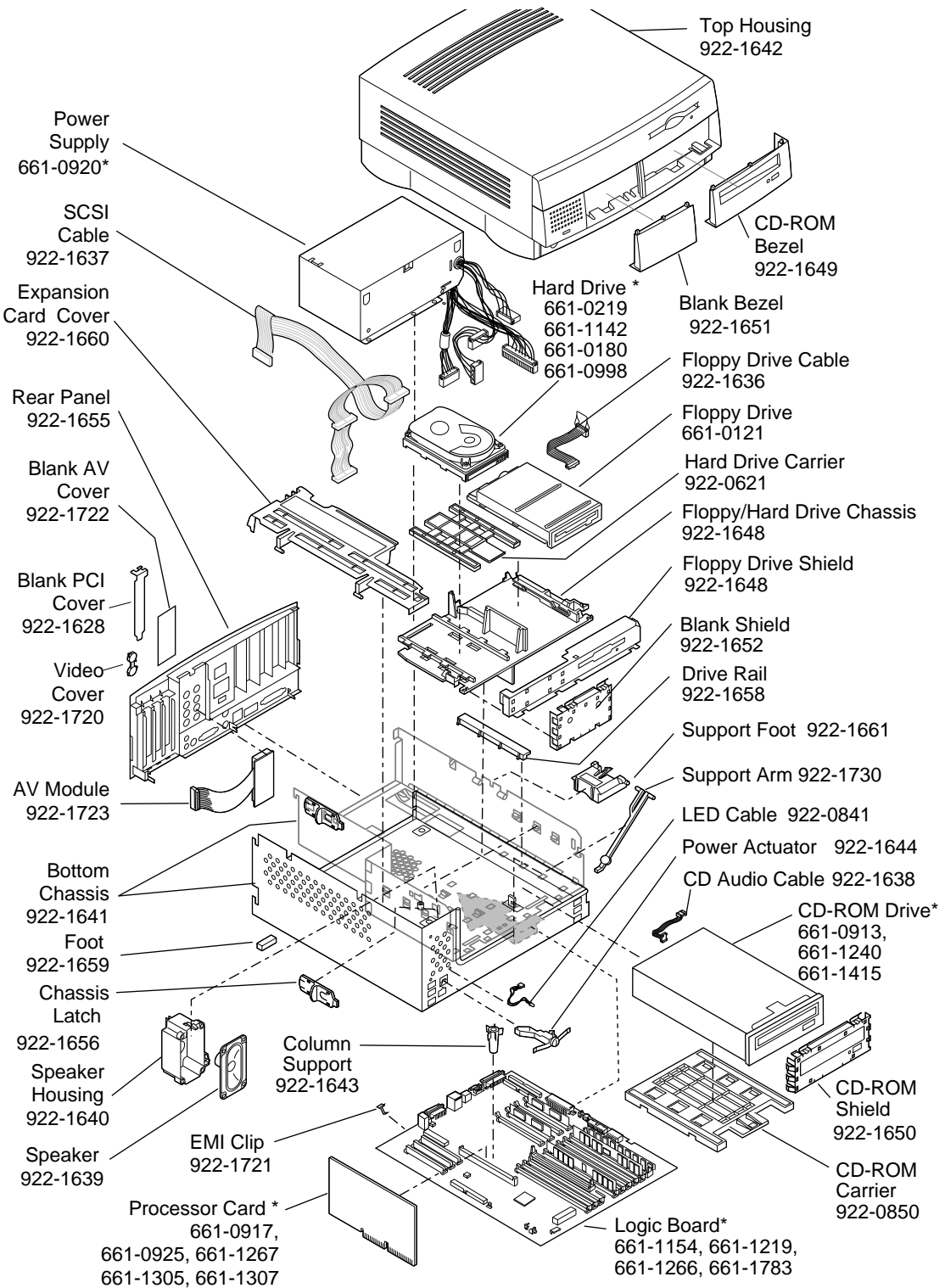

Product family configurations may vary. For parts with asterisk (*), refer to parts list.

Power Macintosh 7300/WS7350/7500/7600

