

PowerBook G4 (15-inch FW 800)  
PowerBook G4 (15-inch 1.5/1.33GHz)

---

Updated 12 November 2004

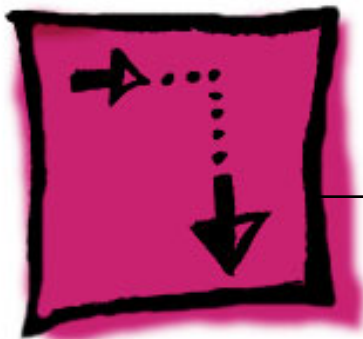

## Adjustments

---

PowerBook G4 (15-inch FW 800)  
PowerBook G4 (15-inch 1.5/1.33GHz)

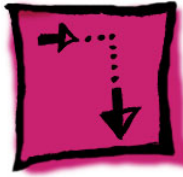

# Latch Adjustment

## Overview

If the display latch does not secure the display to the top case, or releases before the latch button is pushed, an adjustment to the latch hook can be made to correct this. Alternately, the computer can be sent to the Apple Repair Center for service.

The display latch consists of a latch mechanism under the top case (it's actually attached to the bottom case frame) and a pivoting latch hook within the display assembly. The hook is pulled down into the latch mechanism by a magnet as it approaches the top case, and is secured under an overhang on the latch mechanism.

## Tools

This procedure requires the following tools:

- Black stick (or other non-marring nylon or plastic pointed tool)
- Magnet

## Preliminary Steps

**Warning: While performing the following procedures, notice the hook as it is pulled out of the display housing and into the slot in the top case. If an adjustment to the latch hook is performed later, the hook must be adjusted only very slightly, to stay within the slot on the top case.**

Before performing the latch adjustment, test the current operation of the latch:

1. Push the display down to about two inches from the top case. Then push the display very slowly until it just touches the top case, and immediately release.

If working properly, the latch should secure the display to the top case through the following tests:

- Pound on the table top, left and right of the computer.
- Pull up on the sides of the display.

Repeat the above procedures several times to verify the operation of the latch.

2. Whether or not the latch functioned properly, use the following procedures to achieve or verify proper latching function.

---

## Procedure

**Note:** The latch mechanism under the top case of the computer has a small amount of right and left play (less than 1 mm), and can shift during normal operation.

The following procedures will test the latching function with the latch mechanism at its maximum right and left positions, and the latch hook will be very slightly bent, as necessary.

**Important:** The latch hook metal can become brittle and break if it is bent too much, especially if it is over-bent and bent back. Work carefully and with restraint to avoid over bending the latch hook. If the latch hook breaks, the entire display panel assembly will need to be replaced.

1. Open the display and use a black stick to push the latch mechanism, at the location shown, to move it to the right as far as it will go (less than 1 mm).

**Note:** You may not notice movement if the latch mechanism was already in this position.

**Note:** In this position, the latch mechanism has the least overhang available to catch the latch hook, so this would be the “worst-case” position.



2. Perform the testing procedures in step 1 of the Preliminary Steps, above.
3. If the latch functions properly, skip to step 7, but refer back to the procedures below, if the latch hook requires an adjustment.

4. If the latch does not function properly, adjust the latch hook as follows:

Open the display to a 90-degree angle and use a magnet to pull out the latch hook and tightly grasp it between your thumb and forefinger as close to the display as possible, as shown.



5. Carefully exert a very slight controlled downward pressure on the latch hook.

**Important:** Do not push only with your thumb. Hold the latch hook tightly between your thumb and forefinger to support the latch hook and prevent too much bending force.

6. Release the latch hook and perform the latch tests as before. Continue the above procedure until the latch functions properly.
7. Use a black stick to push on the latch mechanism, at the location shown, to move it to the left as far as it will go (about 1 mm).

**Note:** This is the ideal latch mechanism position and the mechanism will be left at this location.

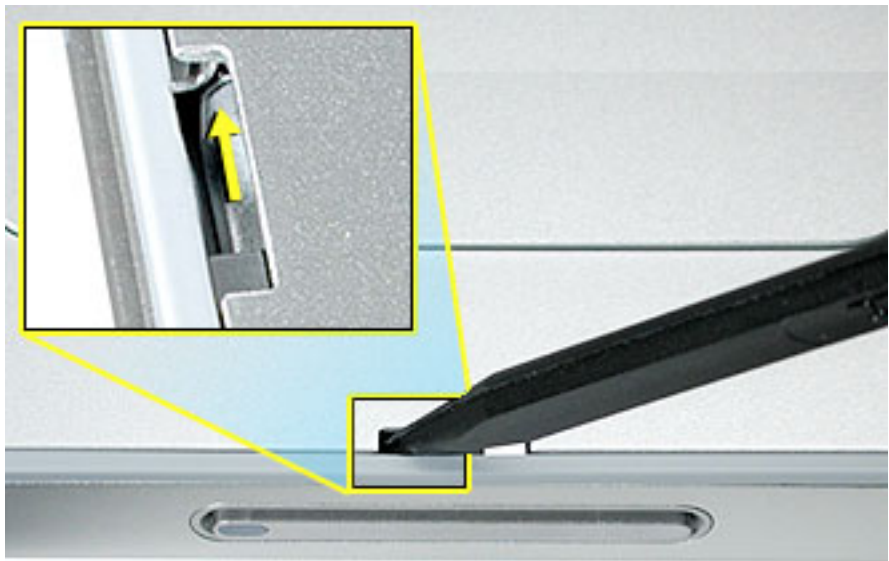

When you push the latch mechanism correctly, you will notice the mechanism move, where shown below.

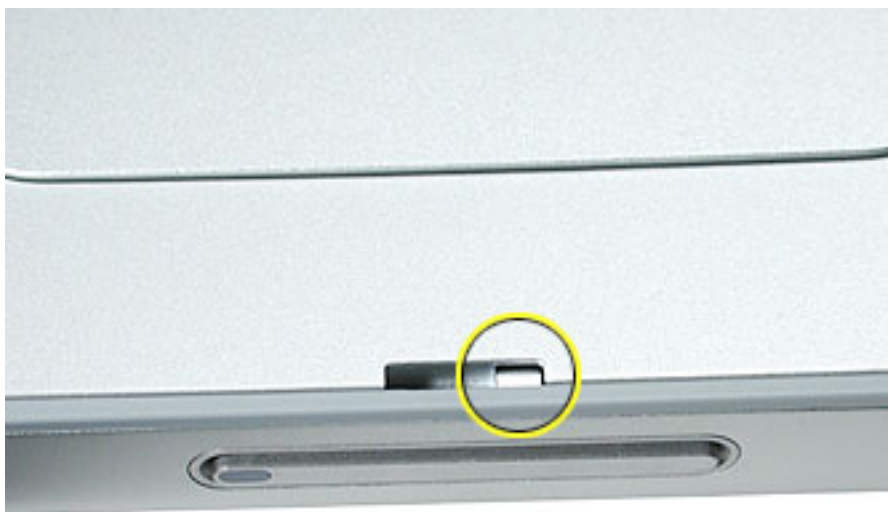

8. Repeat the previous latch closing tests, and latch hook adjustment if needed, until the latch works properly in this position.

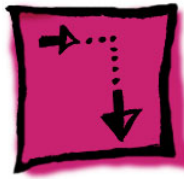

# Display Rear Housing Adjustment

## Overview

Earlier display rear housing parts include a shim set on each side of the logo diffuser on the inner side of the housing. New replacement display housing parts include a new softer diffuser and no shim set. When you are replacing an LCD panel in a display assembly, you must either replace the display housing with a new display housing, or remove the shim set and replace the diffuser on the existing display housing. Follow this procedure to modify an earlier display housing.

## Tools

This procedure requires the following tools:

- LCD panel with new softer diffuser
- Black stick (or other non-marring nylon or plastic pointed tool)
- Cloth rag
- Solvent to remove adhesive (such as Goof-Off goo remover)
- Fine-point permanent marking pen with black ink
- Compressed air
- Logo diffuser 922-6342 (included with replacement LCD panels)

---

## Preliminary Step

Before performing the display rear housing adjustment, check the current housing. If it appears as shown below (with a set of shims on both sides of the logo diffuser), continue with the procedure.

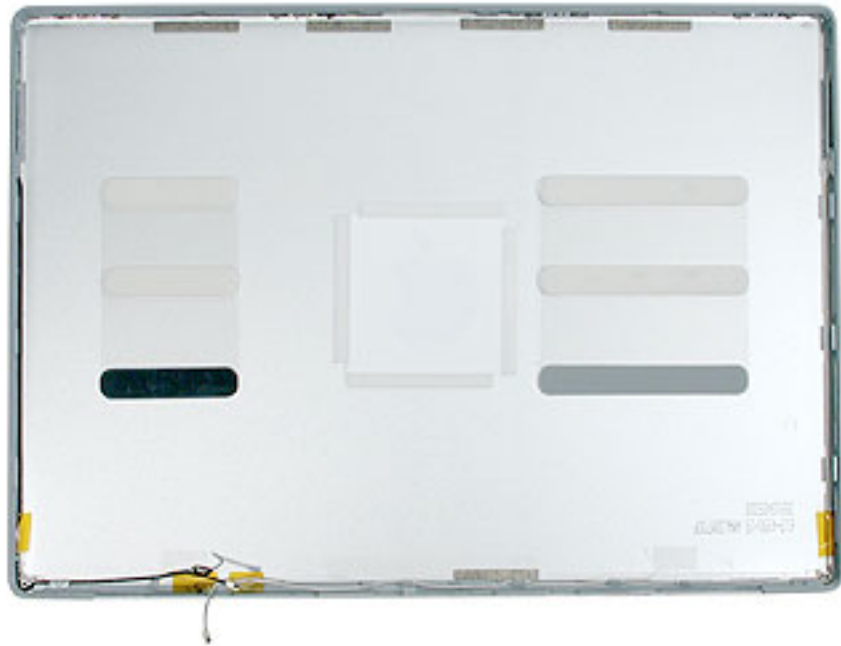



---

## Procedure

**Important:** The logo diffuser protects the Apple logo on the back of the housing. To protect the logo from damage, do not remove the diffuser until after the sets of shims have been removed.

1. Using a black stick, start to loosen the two sets of shims.

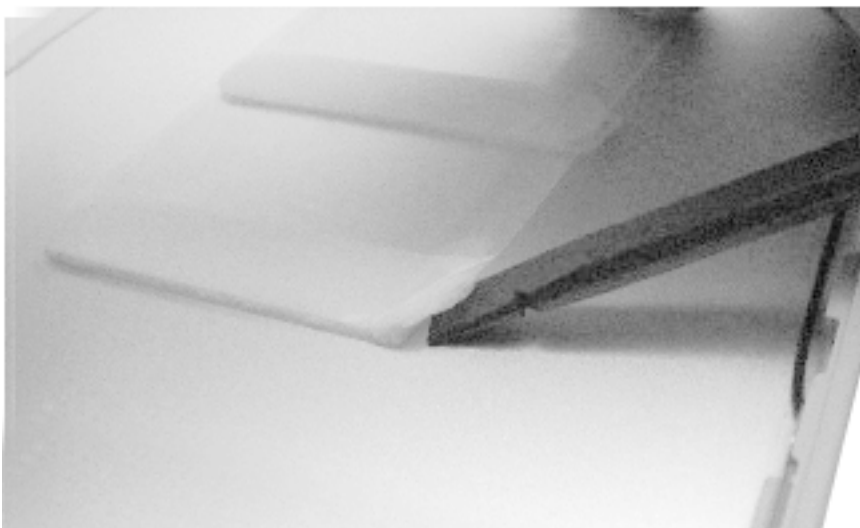

2. With one end loosened, peel up the sets of shims.

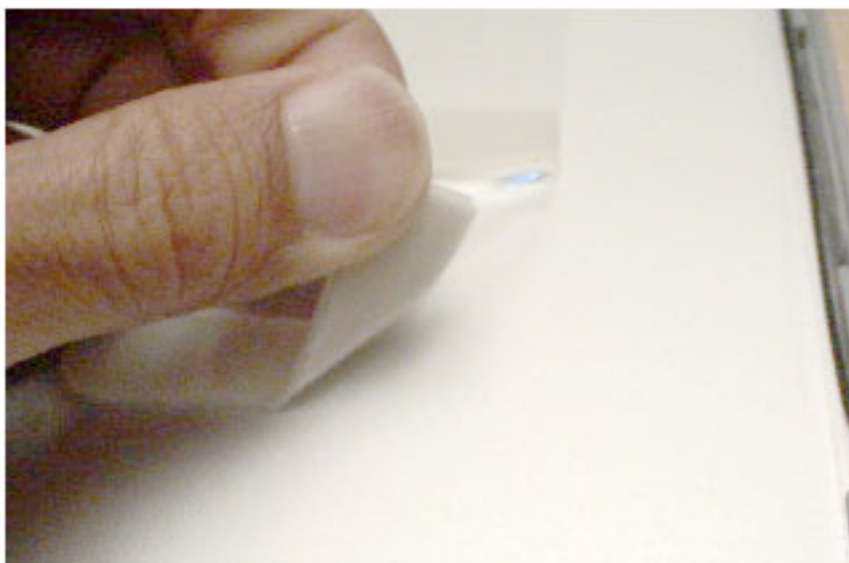

3. If part of the foam strip sticks to the housing, remove it with a black stick or your fingers.

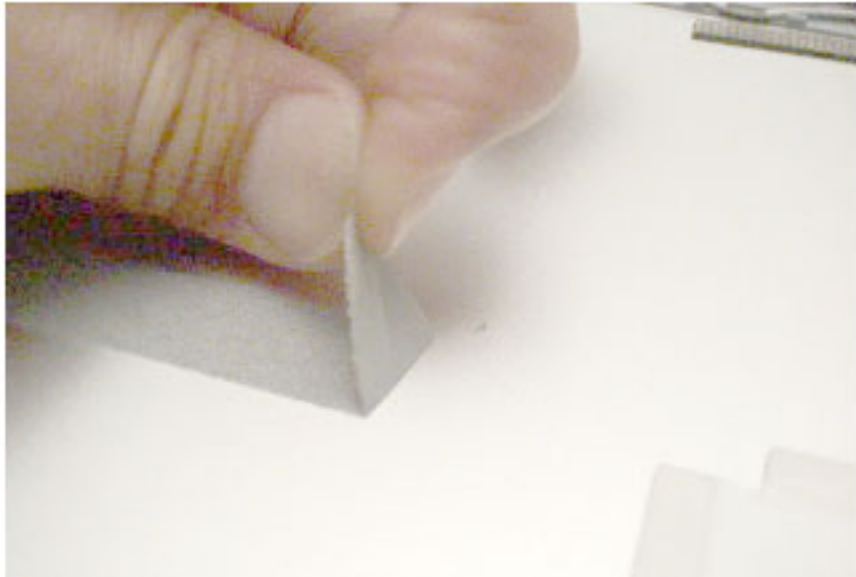

4. If a patch of adhesive remains on the housing, use a small amount of solvent on a rag to clean off the area.



5. Rub the patch until the adhesive is gone and the housing is clean.

- 
6. With the two sets of shims removed, the housing should appear as shown below with the square diffuser in the center of the display housing.

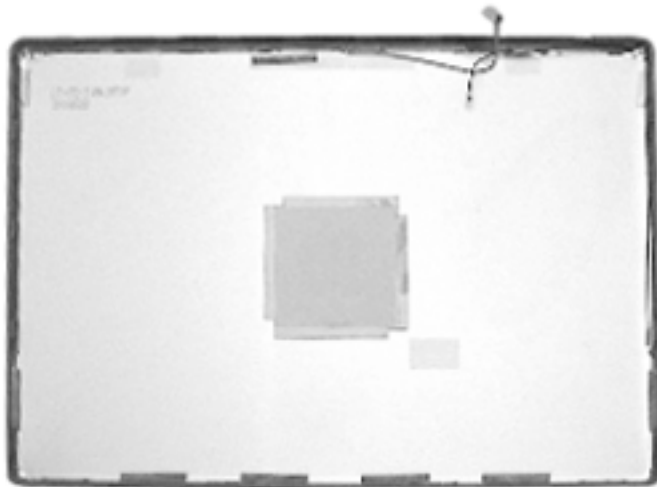

7. To prepare the housing for placement of the new diffuser, use a permanent marking pen along the four sides of the diffuser.



- Using a black stick, carefully pry up the diffuser foam at one corner, and pull it back.

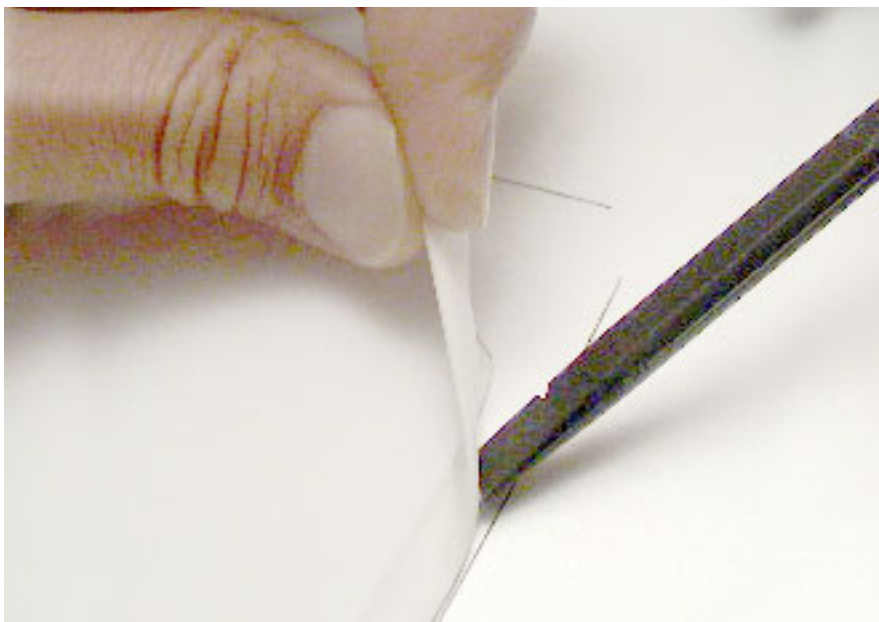

- Use the black stick to loosen all four sides of the diffuser. Be careful not to mar the logo.
- Pull the diffuser off.

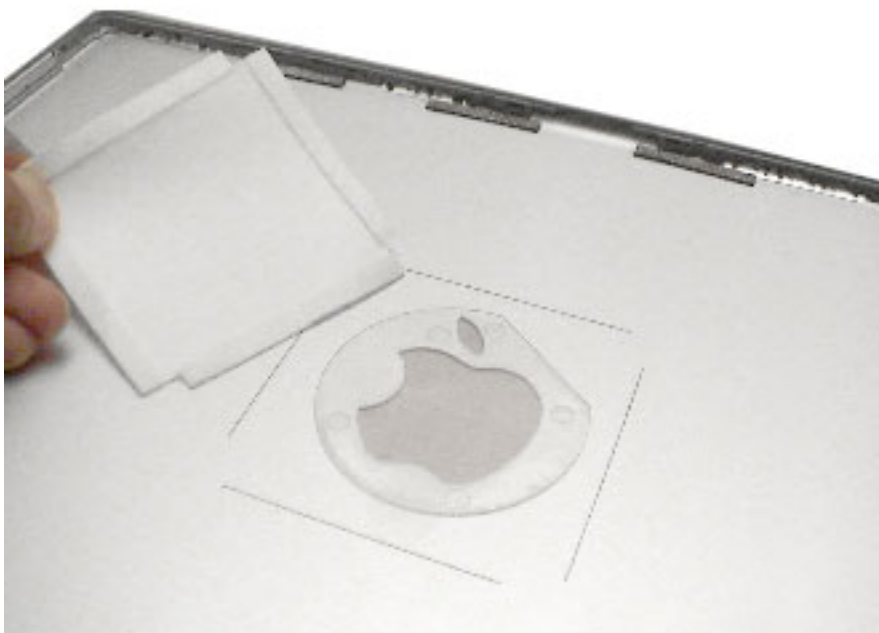

- 
11. **Important:** Before applying the new diffuser, make sure nothing adheres to the clear plastic window. If necessary, use an air compressor to remove any dust or particles.

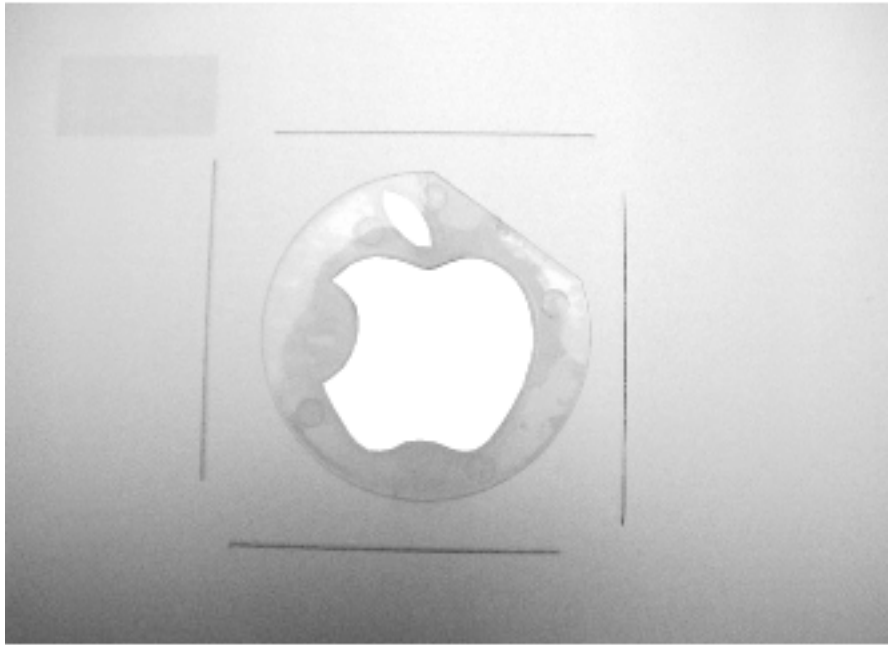

12. Check both sides of the replacement diffuser to make sure it is completely clean.



- 
13. Remove the backing on the foam strips.

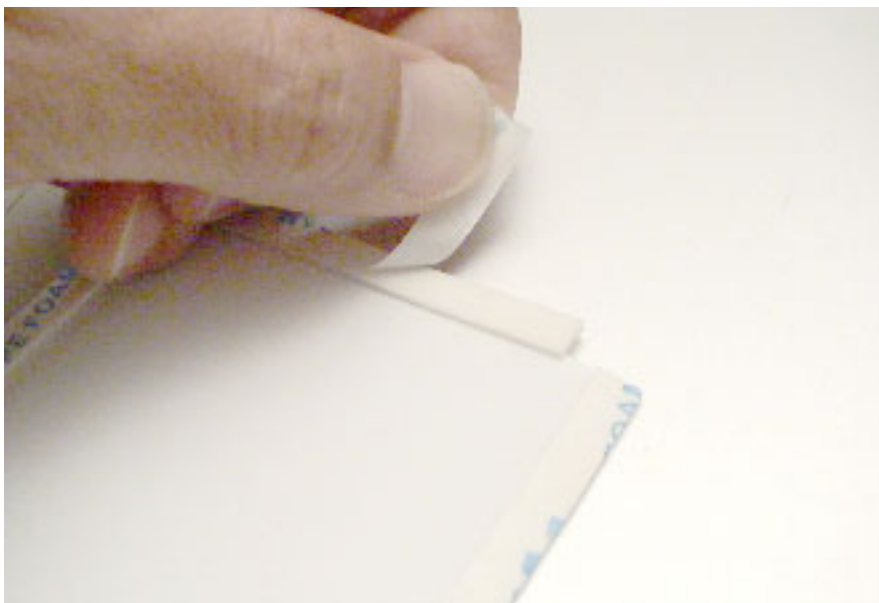

14. Because the diffuser is square, you may orient it in any way as long as it aligns with the pen lines on the housing. Place it straight against one line, and allow the foam strips to adhere to the housing and match up to the other pen lines.

**Important:** To avoid creating pressure points on the LCD panel, the adhesive foam must not ride up onto the plastic of the logo at any point, even slightly. Check this by running your finger along the foam. If it goes over the logo plastic, reapply the diffuser.

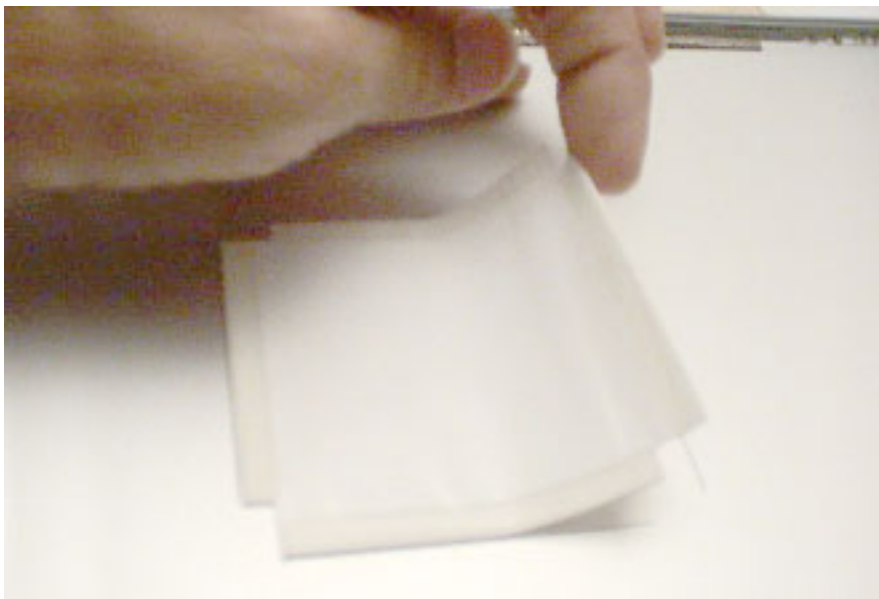

- 
15. With the diffuser secured on the housing, peel up the clear, protective film backing if it is installed. The backing will appear wrinkled if it is in place.
  16. To make sure that the diffuser is installed correctly, hold the display housing up to a strong light and visually inspect the position of the foam strips to the clear plastic window. If you see an overlap, remove the diffuser and make sure a new one is installed correctly.

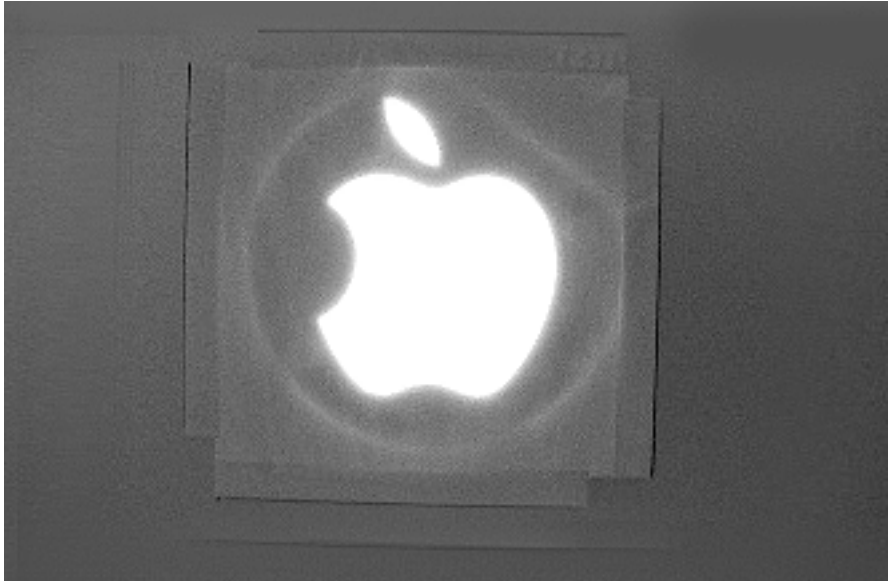

17. As a final check, turn over the housing and inspect the Apple logo for contamination. The logo should be uniformly white.





## Take Apart

---

PowerBook G4 (15-inch FW 800)  
PowerBook G4 (15-inch 1.5/1.33GHz)





# General Information



## Overview

The main differences between the two computers covered in this manual are:

PowerBook G4 (15-inch FW800)

- 1.0 and 1.25 GHz logic boards
- Standard modem
- ATI Mobility Radeon 9600 graphics chip

PowerBook G4 (15-inch 1.5/1.33GHz)

- 1.33 and 1.5 GHz logic boards
- Apple internal 56K modem (April 2004)
- ATI Mobility Radeon 9700 graphics chip
- Thermal paste is used on the heatsink for the graphics chip mating surface

---

Some key features common to both that distinguish these computers from earlier PowerBook models include:

- New aluminum alloy enclosure
- Built-in Bluetooth
- Built-in FireWire 800 port
- Supports USB 2.0
- Uses double-data rate (DDR) memory
- Optional AirPort Extreme card
- Optional fiber optic backlit keyboard with ambient light sensors
- New battery pack

## New Procedures

If you are familiar with taking apart notebook computers, there are a few critical differences:

- **Important:** The top case removal has two critical removal steps:
  - Clips behind the optical drive felt must be disengaged before the top case can be lifted off.
  - There are two flex cables (keyboard and multifunction trackpad) from the top case to the logic board. Carefully lift the top case to avoid pulling these connectors off the main logic board.
- The keyboard is secured with screws accessible from under the top case.
- Memory cards are easily accessible from the bottom of the computer. **Important:** To avoid applying too much pressure onto the memory slot locking tabs, spread the tabs apart when installing memory cards.
- The AirPort Extreme card is easily installed or replaced through a door in the main battery compartment.
- The quantity and types of screws differ from earlier models.

## Important Memory Note

Memory from the previous 15-inch (Titanium) PowerBook is not compatible with this computer.

Memory from the PowerBook G4 (15-inch FW800) is compatible, however, not all memory compatible with the PowerBook G4 (1.5/1.33GHz) will be compatible with the PowerBook G4 (15-inch FW800).

---

## Tools

The following tools are recommended for the take apart procedures.

- ESD wrist strap and mat
- Soft cloth
- #0 Phillips screwdriver (magnetized)
- #1 Phillips screwdriver (magnetized)
- 4 mm socket wrench
- 5 mm socket wrench
- 1.5 mm Hex key (or Torx T6)
- Needlenose pliers
- Torx T8 screwdriver
- Torx T6 screwdriver
- Thermal pad kit (076-1055)
- EMI gaskets kit (076-1057)
- Alcohol pads
- Black stick (nylon probe tool 922-5065) (or other nonconductive nylon or plastic flat-blade tool)
- Multi-compartment screw tray (such as a plastic ice cube tray)
- Double-stick tape
- Kapton® tape (922-1731)
- Voltmeter (for troubleshooting)
- Small low-power magnet (for troubleshooting)
- Apple Pro keyboard and mouse (for troubleshooting)

---

## Serial Number Location

The serial number is located in the battery bay.





# Foot



## Tools

This procedure requires the following tools:

- Foot kit
- Tweezers or needlenose pliers
- Soft cloth

## Preliminary Step

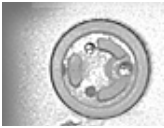
Before you begin, check the foot location that needs replacement and verify that the case plug is attached. Also verify that the case plug, and the case foot in the kit, match the pictures below.

Plug Area on Bottom Case	Matching Foot	Action
Missing case plug 	Not available for replacement	Replace the bottom case, or send to Apple Repair Center.
Case plug 	Case foot 	Continue with the procedure, matching the foot to the plug on the bottom case.

---

## Procedure

**Warning:** The glue used in this procedure can bond instantly to skin. Do not touch the glue. In the event of contact, review the safety instructions at the end of this document. For additional information, refer to the glue manufacturer:

Elmer's Products, Inc.  
Columbus, OH. 43215-3799  
[www.krazyglue.com](http://www.krazyglue.com)

1. Place the computer upside down on a clean, lint-free cloth or other nonabrasive surface.
2. Select a foot from the kit. Verify that the case plug and case foot match (refer to the images shown in the table). Do not use a foot that does not match.
3. Make sure the plug area on the bottom case is clean. If any portion of the soft rubber foot remains, remove it so that only the hard plastic plug is visible.

**Important:** When positioning the foot, make sure the indents and bumps of the rubber foot match up and fit into the corresponding indents and bumps in the plug. This ensures a balanced and level fitting. (Note: The picture below is of a different foot than on the computer, and is for illustration only.)



- 
4. **Warning:** GLUE IS AN EYE AND SKIN IRRITANT. BONDS SKIN INSTANTLY. Do not touch the glue at any time. Before opening the glue, review the safety instructions at the end of this document.

**Important:** The glue tube included in the kit is sealed until first use. Do not break the seal until you are ready to use the glue. To break the seal, hold the tube upright and away from you. Place the hollow nozzle cap on the tube and tighten it all the way down. The tube is then ready to dispense the glue through the nozzle cap.



5. Apply one drop of glue to the plug on the bottom case. Do not spread the glue.
6. Using tweezers or needle-nose pliers, carefully position the new foot so its textured surface fits into the inner ring of the plug.
7. Using the end of the tweezers or pliers—not your finger—lightly press and hold the foot in place for 30 seconds.



8. Before turning over the computer, allow the glue to set for at least 15 minutes.
9. Discard the tube of glue.

**SAFETY INSTRUCTIONS:** GLUE IS AN EYE AND SKIN IRRITANT. BONDS SKIN INSTANTLY. Contains ethyl cyanoacrylate. Avoid contact with skin and eyes. If eye or mouth contact occurs, hold eyelid or mouth open and rinse thoroughly but gently with water only for 15 minutes and GET MEDICAL ATTENTION. Liquid glue will sting eye temporarily. Solidified glue may irritate eye like a grain of sand and should be treated by an eye doctor. If skin bonding occurs, soak in acetone-based nail polish remover or warm soapy water and carefully peel or roll skin apart (do not pull). Contact through clothing may cause skin burn. If spilled on clothing, flush with cold water. Avoid prolonged breathing of vapors. Use with adequate ventilation. KEEP OUT OF REACH OF CHILDREN.



# Battery

## Tools

This procedure requires the following tools:

- Soft cloth
- Coin

## Part Location



## Preliminary Steps

**Warning:** Always shut down the computer before opening it to avoid damaging its internal components or causing injury. After you shut down the computer, the internal components can be very hot. Let the computer cool down before continuing.



---

## Procedure

**Warning: If the computer has been recently operating, allow it to cool down before performing this procedure.**

1. Shut down the computer.
2. Disconnect the power cord and any other cables connected to the computer.
3. Place the computer face down on a soft cloth.
4. Insert a coin in the battery lock slot and turn it one quarter turn clockwise. The battery should raise up slightly. Lift the battery out of the battery bay.





# Memory Door and Memory Cards

## Tools

This procedure requires the following tools:

- Soft cloth
- #0 Phillips screwdriver

## Part Location

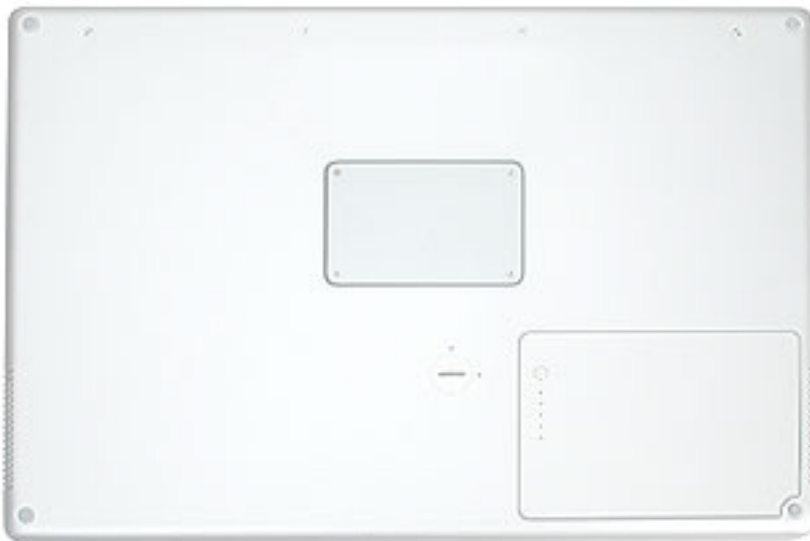

## Preliminary Steps

Before you begin, remove the battery.

---

## Procedure

**Warning:** If the computer has been recently operating, allow it to cool down before performing this procedure.

1. Place the computer face down on a soft cloth.
2. Remove the four screws from the memory door then remove the door.

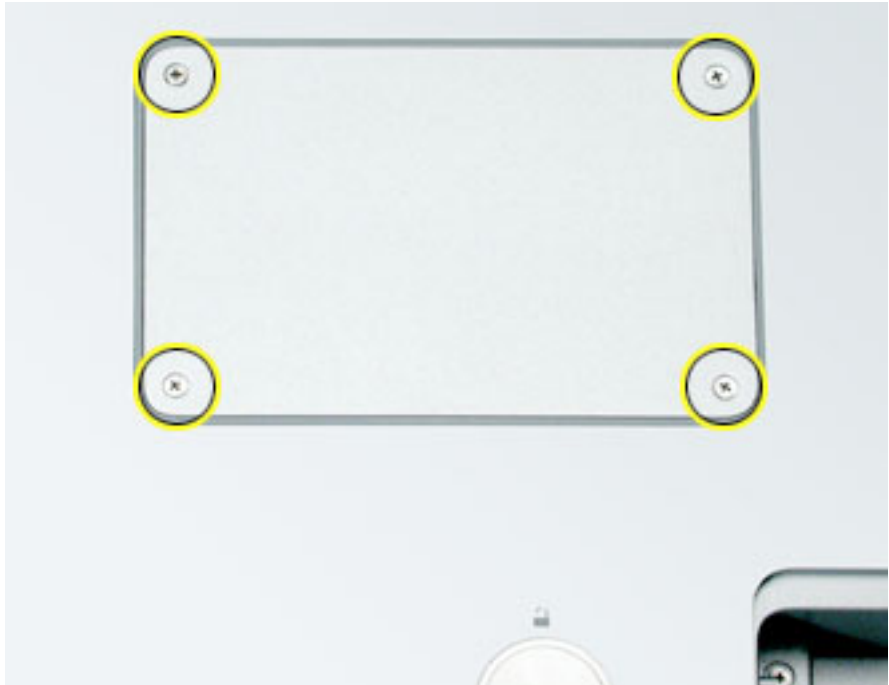

**Note:** If only one memory card is installed, the factory installs it in the bottom memory slot.

**Note:** Memory must be removed from the top slot before removing from the bottom slot.

3. To remove memory cards, carefully spread the two locking tabs for the slot (top or bottom) away from the card on both sides and allow the card to pop up slightly.



4. Pull the card straight back and out of the memory slot.



## Replacement Procedure

### Notes:

- The top and bottom memory cards are inserted at different angles.
  - If installing two cards, install into the bottom slot first.
  - Align the notch in the memory card with the tooth in the slot before inserting.
1. To install a memory card into the bottom slot, insert the card at a low angle behind the locking tabs of the top slot.

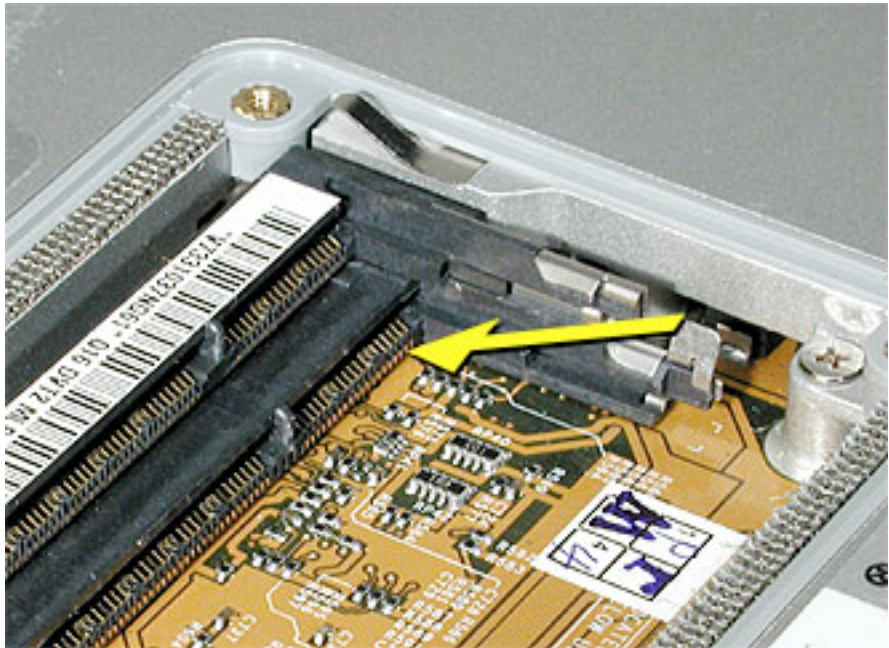

- Slide the card forward to the lower slot. Firmly push the card straight into the slot until it is fully and securely seated along its length.

**Note:** If the back of the card drops down before it is fully seated, raise it up enough to push it fully into the slot.

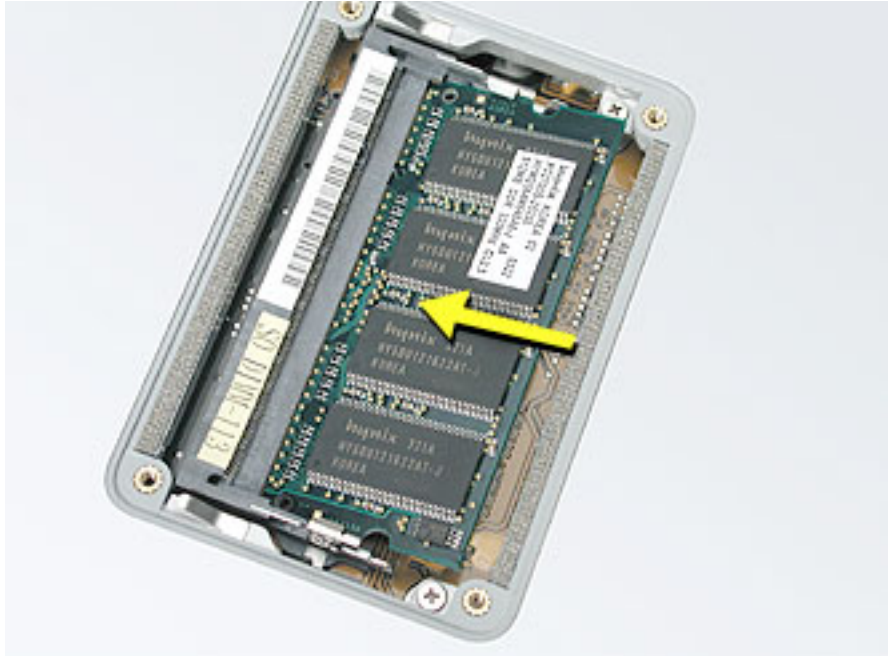

- Carefully spread the two locking tabs for the bottom slot away from the card on both sides while pushing the card straight down until the tabs click onto both sides of the card, locking it into place.

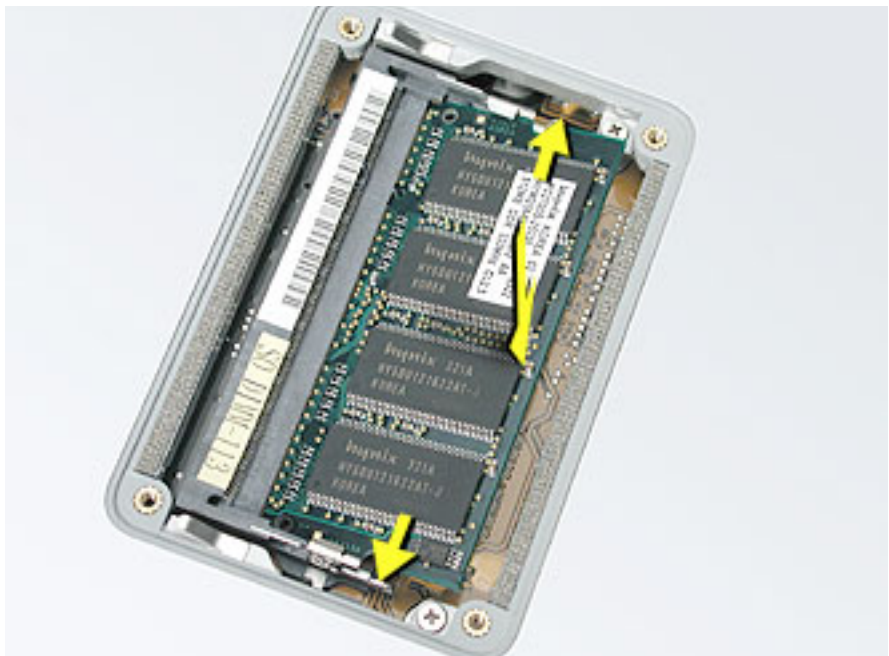

4. If installing a memory card in the top slot, follow the same procedures as the bottom slot except insert the card at a 30-degree angle, above the locking tabs.

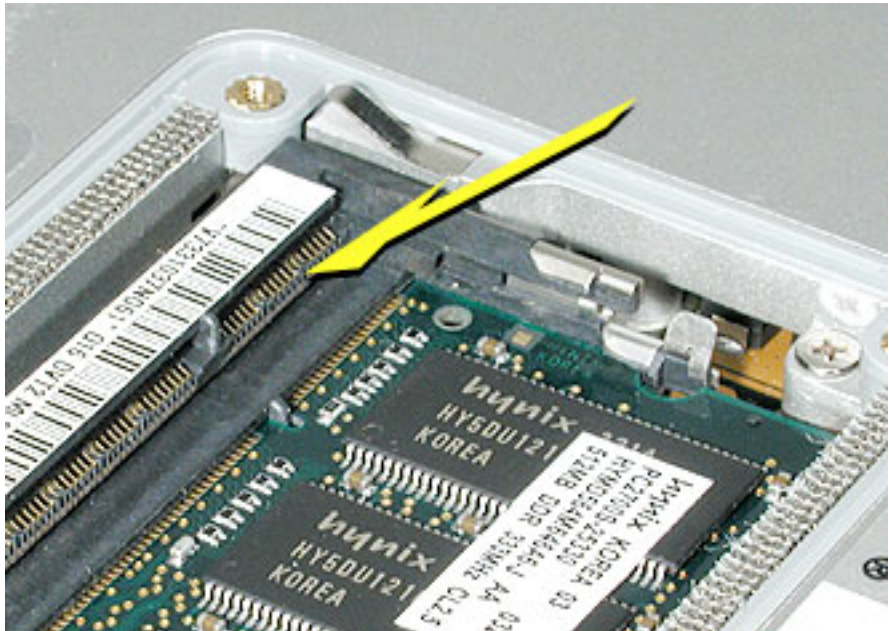

5. Push the card in until it is firmly seated.
6. As with the bottom slot, spread the locking tabs for the top slot while pushing the card straight down until it locks into place.



7. Cards should be flat and secure on both sides.



8. Install the memory door.
9. Replace the battery.
10. Use Apple System Profiler to verify that the memory is recognized. (Choose the menu bar Apple logo (🍏) > About This Mac, click More Info..., select the System Profile tab, open the Memory Overview.)





# AirPort Extreme Card

## Tools

This procedure requires the following tools:

- Black stick (or other nonconductive nylon or plastic flat-blade tool)

## Part Location



## Preliminary Steps

Before you begin, remove the battery.

## Procedure

1. Pull outward on the slot to open the AirPort Extreme Card door.



2. Use a black stick to pull out the card's clear plastic pull tab, tucked underneath.

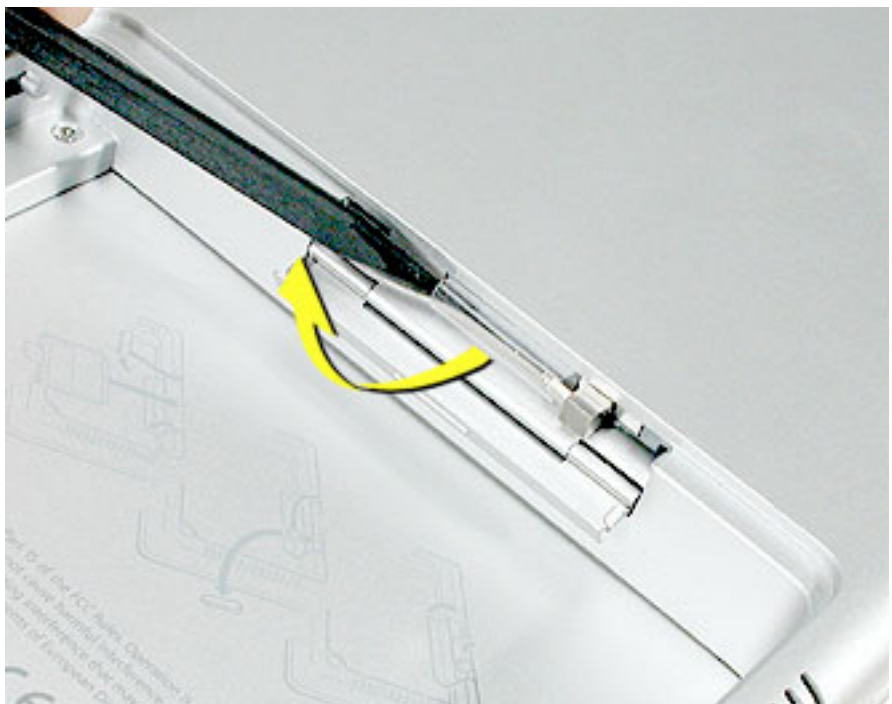

3. Gently disconnect the AirPort Extreme antenna cable.



4. Use the pull tab to pull out the card.



5. Slide the replacement AirPort Extreme Card into the slot, as shown.

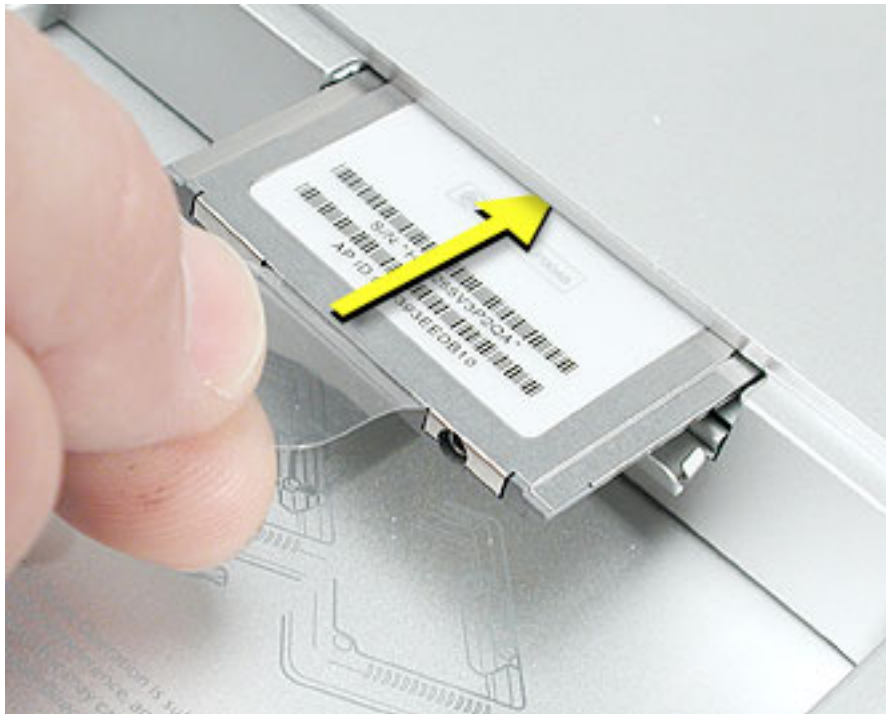

6. Push the card into the slot until fully seated.



7. Connect the end of the antenna cable to the card.



8. Loop the clear plastic tab down around the antenna cable and tuck it into the slot under the card so that it secures the cable.

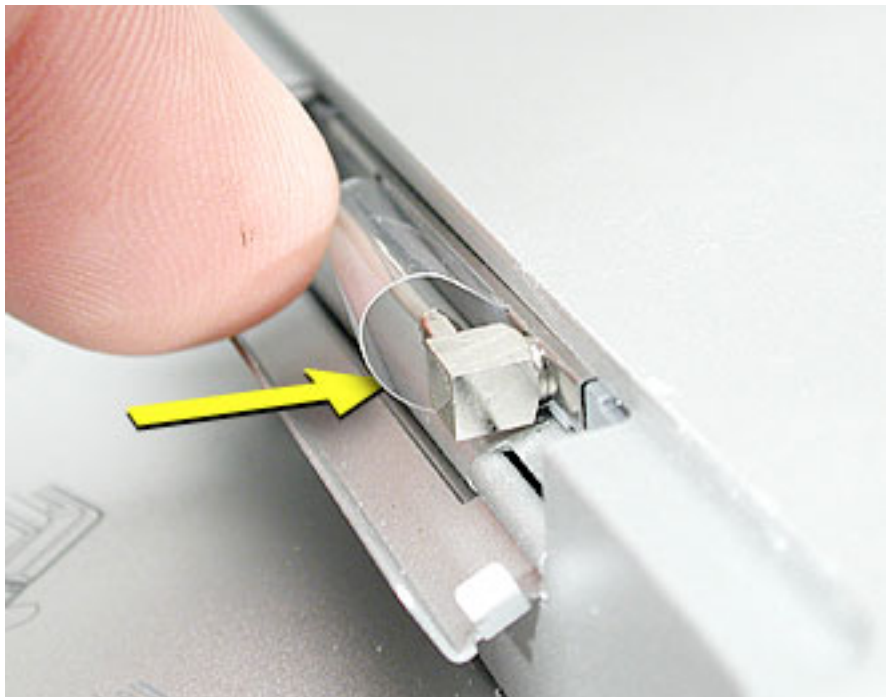

9. Close the AirPort door, reassemble and test the computer.





# Top Case

## Tools

This procedure requires the following tools:

- #0 Phillips screwdriver (magnetized)
- 1.5 mm Hex key (or Torx T6)
- Black stick (or other nonconductive nylon or plastic flat-blade tool)
- Soft cloth
- Multi-compartment screw tray

## Part Location



---

## Preliminary Steps

Before you begin, remove the following:

- Battery
- Memory door

## Procedure

**Note:** This procedure removes the top case and keyboard assembly. The keyboard is removable only after removing the top case.

1. Place the computer face down on a soft cloth.
2. Remove the two screws inside the battery bay.
3. Remove the two screws from the memory bay.
4. Remove the four screws along the back edge.





- 
5. With the display open, rest the computer on one side. Remove the three screws.



6. Turn over the computer and remove the three screws on the other side.



- 
7. Open the computer slightly and rest it with the back facing up. Remove the two top screws along the back.

**Note:** Do not remove the bottom screws.



8. Lay the computer right side up and open the display slightly past 90-degrees.
9. Remove the two hex screws at the back corners of the top case (a Torx T6 can also be used).



10. To help release the top case, use a black stick along the front left seam of the top and bottom case.

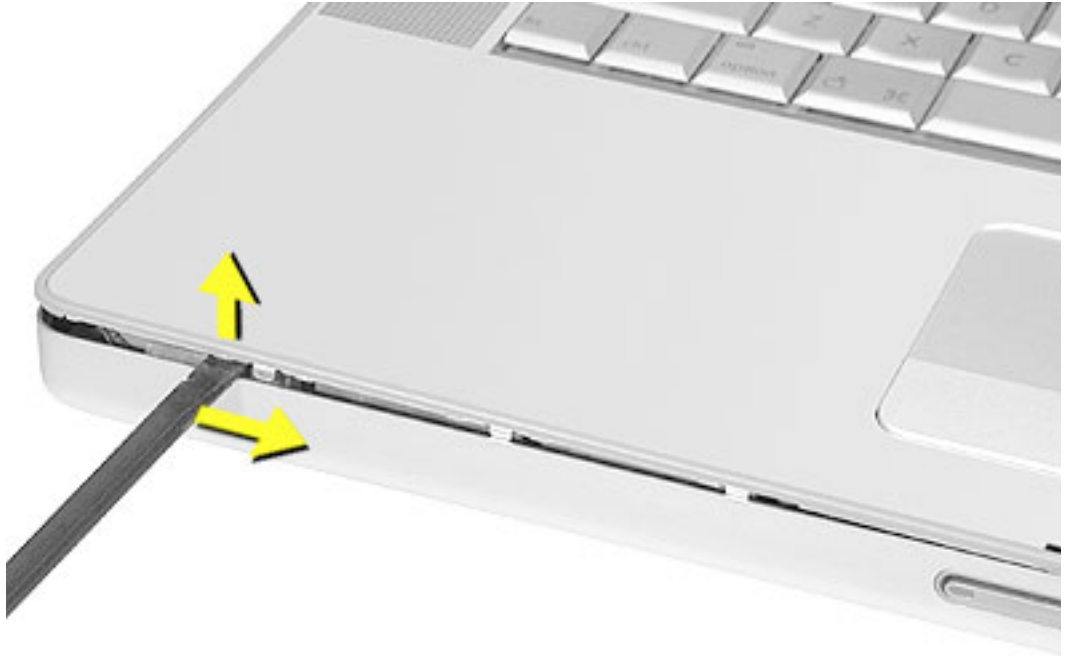

11. And along the back sides (gently twisting the black stick may help).

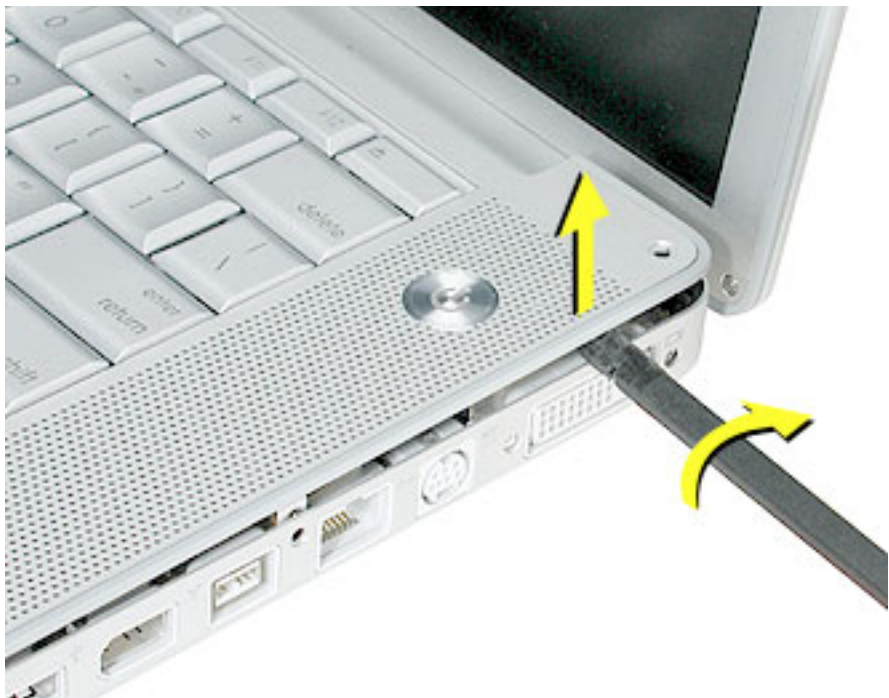

12. Lift up the back of the top case to about a 45-degree angle to bend out the securing clips along the front right edge of the top case (behind the optical drive slot).



13. Lower the top case and carefully wiggle it forward and up to release it. Repeat step 12 if clips along the optical drive slot, especially along its left side, do not easily release.

**Important:** To avoid damage, do not lift off the top case or strain its cables attached to the logic board.



- 
14. Lift the front of the top case, pivoting along the back, to rest the top case against the display. Do not strain the cables connected to the logic board.



**Important:** Adjust the display so that there is no strain on the top case cables and so the top case will not fall forward.



15. Disconnect the trackpad flex cable.
16. Carefully disconnect the keyboard flex cable. Use a non-marring flat-blade tool to slide the locking bar back slightly on both sides.

**Important:** The keyboard flex cable is a Zero insertion force (ZIF) connector. The locking bar on the connector is extremely fragile and is not intended to separate from the connector. When releasing the bar, use extreme care and a restrained light pressure to move the bar only slightly.

**Warning:** If the locking bar breaks, you will need to replace the logic board.

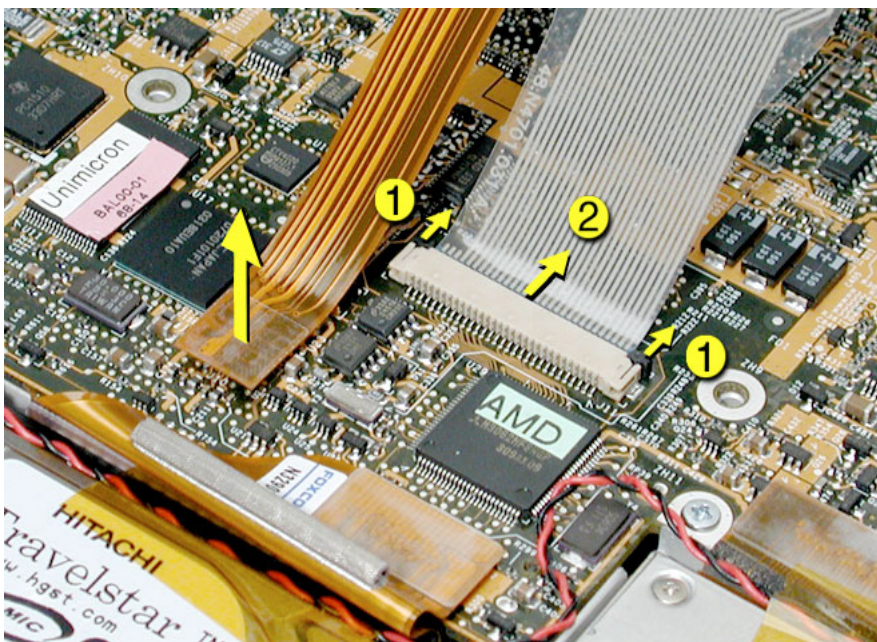

#### **Replacement Notes:**

Make sure the locking bar is released, then slide the end of the flex cable all the way into the connector, above the locking bar. Hold the cable in place, then slide the locking bar into the connector on both sides to secure.

**Important:** Verify that the cable is straight. Use the markings on the cable as guides.

**Warning:** If the flex cable is inserted crooked, some signals may not be connected or signals may short together.

**Note:** If a cable is not securing properly, verify that it is inserted on the correct side of the locking bar.

17. Lift off the top case.

## Replacement Procedure

**Note:** If replacing the top case, remove the keyboard and transfer it to the replacement top case.

1. Visually check to verify that all cables are connected and routed correctly with nothing raised up or incorrectly over a component.
2. Check perimeter wiring, where shown, to verify that it will not be caught or pinched by the top case during replacement.

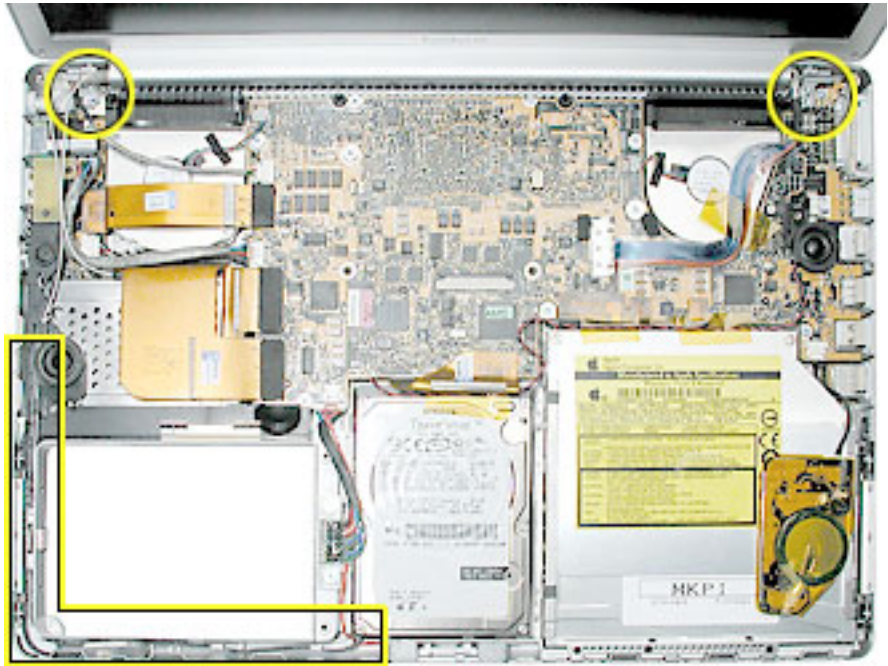

3. Verify that the LVDS cable is secured with Kapton tape and lays flat.

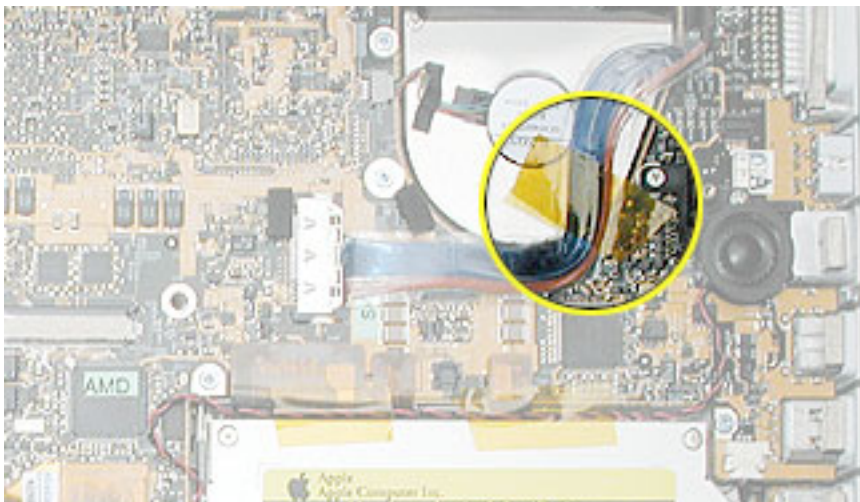

4. On the top case, check cable connections and routing.

**Note:** The top case below has the wires and connector for the fiber optics for the optional backlit keyboard (right side). This will not be present on some configurations.

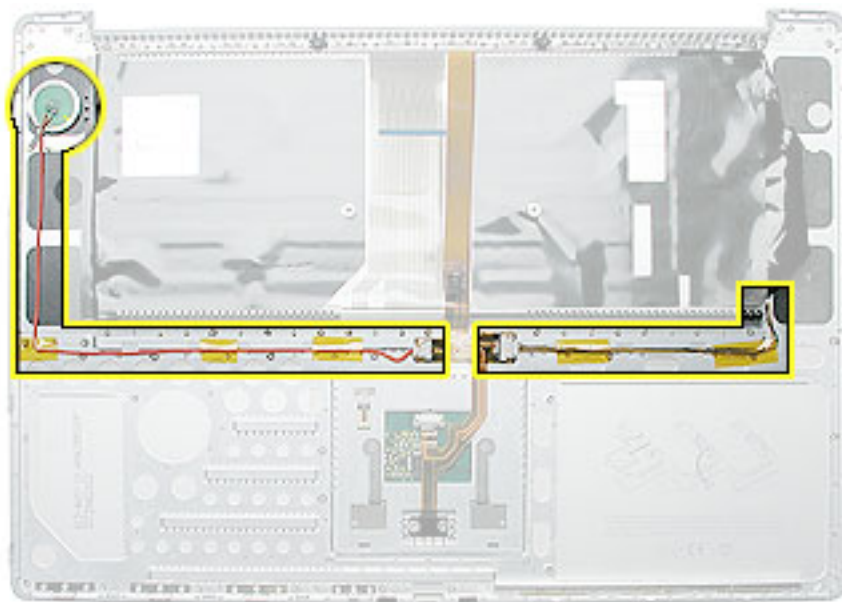

5. Check that the perimeter metal tabs are not bent.

**Note:** The metal quickly fatigues and can break off easily. Be extremely careful to gently straighten tabs, if needed.

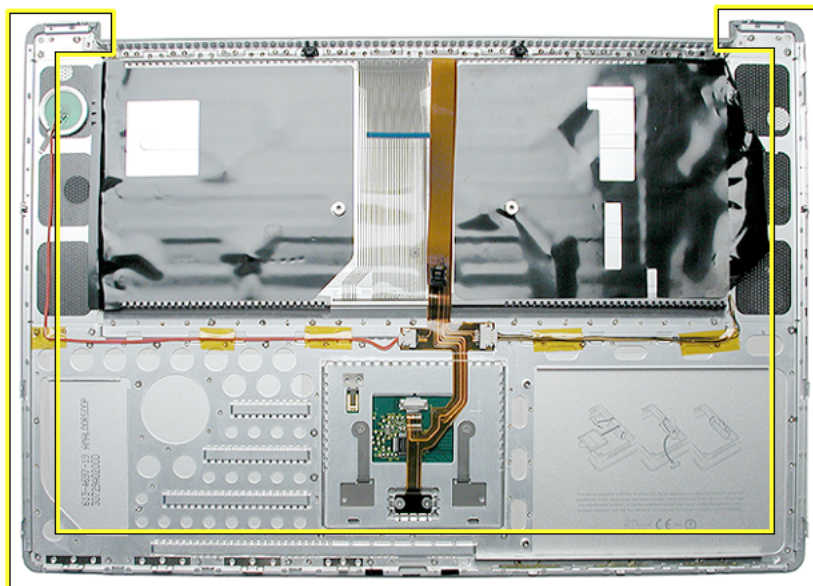



6. Use a black stick with your finger for support to straighten clips as shown.

**Note:** The clips should be vertical.

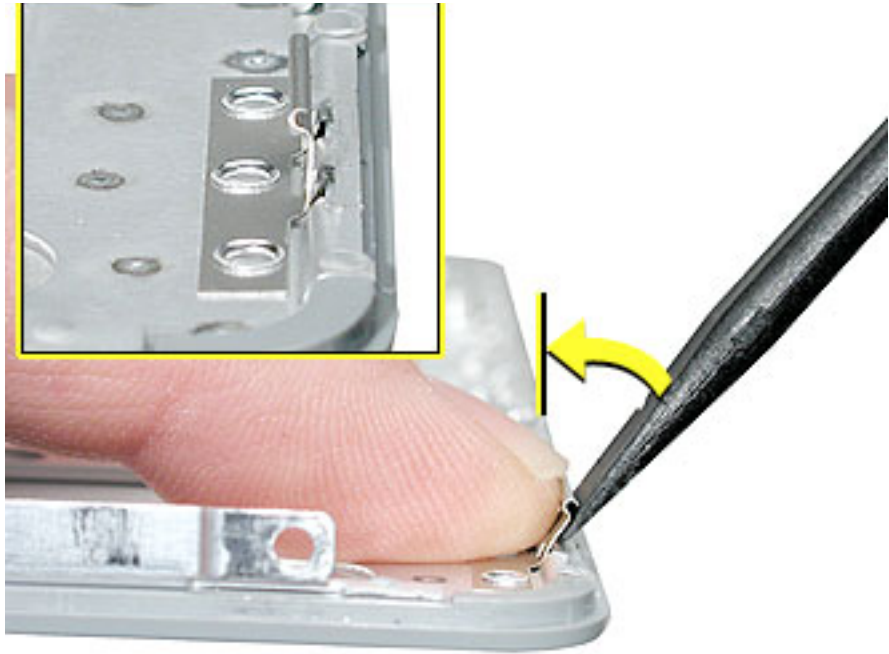

7. Lay the top case against the open display, as shown.



- 
8. Connect the flex cables from the top case to the logic board.
  9. Lift the top case slightly and rotate it down over the bottom case (verify that the cables are folding properly) and align the corners.
  10. Start at the right corner and guide the top case onto the bottom case. Use a black stick to carefully pull or push tabs slightly, if needed.

**Note:** Some side screws have a flexible screw boss. If they block a tab on the top case from seating, use the pointed end of a black stick through the screw hole to push on the boss slightly.

**Important:** The tabs are fragile. Do not apply too much pressure or bend them.

**Important:** The top case should lay flat along the sides and top, if not, make sure that cables and components are not interfering.

**Important:** Screw order is vital for the proper attachment of the top case.

11. Reinstall the side screws in the order shown, below.

- **Replacement Note:** Do NOT insert side screws into the DVI port screw holes. The screws can jam in the holes, requiring removing the logic board to remove.

922-6091



3.4 mm



12. Close the computer, flip it over, and install the four back screws.
13. Install the two screws in the memory bay.
14. Install the memory door and four screws.
15. Install the two screw in the battery bay.

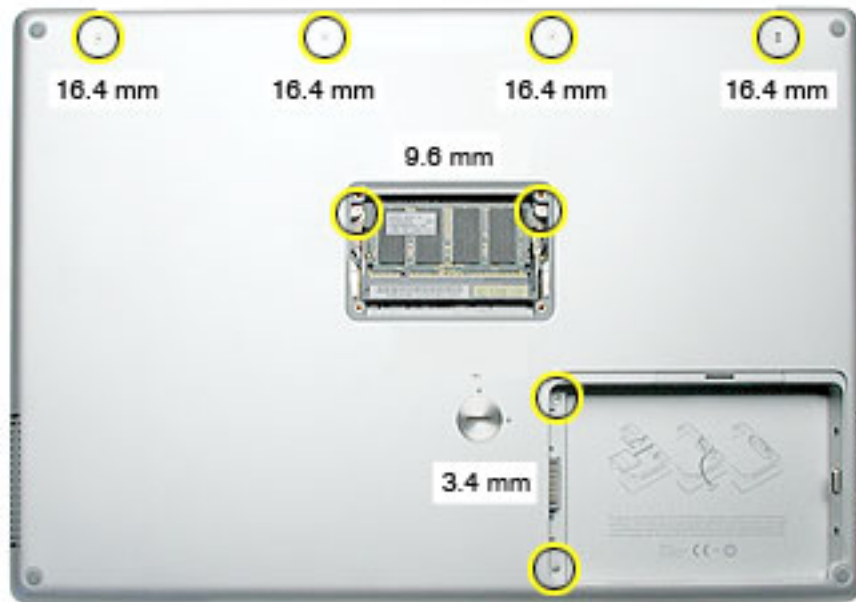

16. Replace the battery.
17. Testing the computer should include powering on, checking the keyboard and trackpad function.

If the computer has the optional keyboard backlight feature, operate the computer in a darkened room to check for keyboard backlight function.



# Keyboard

## Tools

This procedure requires the following tools:

- #0 Phillips screwdriver
- Black stick (or other nonconductive nylon or plastic flat-blade tool)

## Part Location



## Preliminary Steps

Before you begin, remove the following:

- Battery
- Top case

## Procedure

**Note:** There are two different keyboards and top cases used with this computer, depending upon the configuration, either backlit or non-backlit.

**Important:** Verify that the correct replacement keyboard is ordered, and/or top case if replacing. The keyboards are not interchangeable, and damage could result.

The top case for the backlit keyboard has the fiber optics and connector (right side). The keyboard for the backlit top case has icons on the F8 to F10 keys for the backlighting feature.

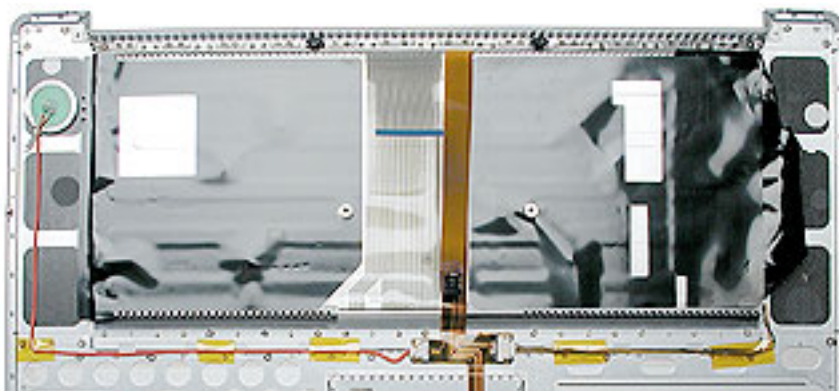

The top case for the non-backlit keyboard does not have the fiber optics and connector. The keyboard for the non-backlit top case does not have icons on the F8 to F10 keys.



1. Turn the top case over and carefully remove the black insulator film. If new film was not provided with the replacement part, reserve the film for reinstallation.

**Important:** If the computer has the fiber optics for the optional backlit keyboard, do not remove the black insulator around the optics and cables.

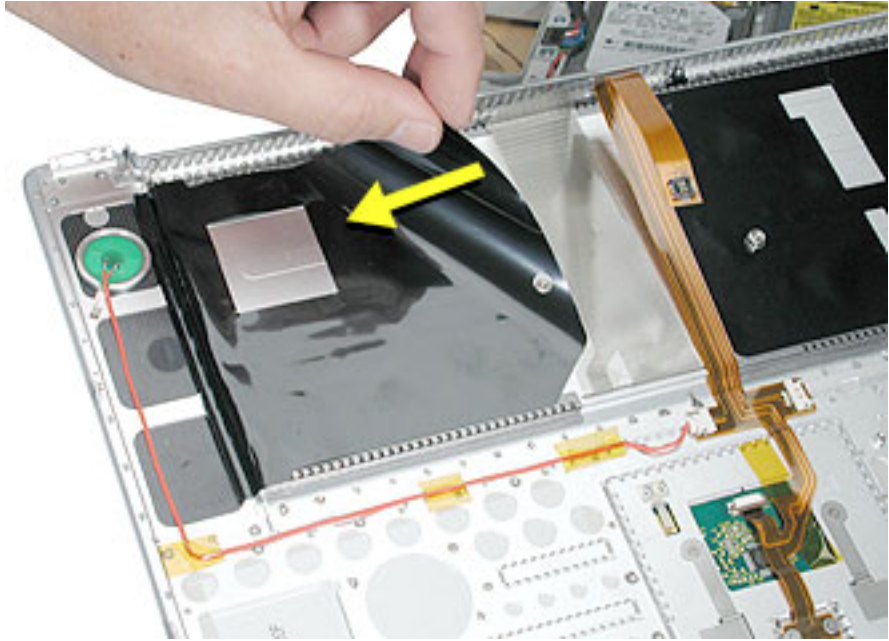

**Important:** If the computer has the fiber optics for the optional backlit keyboard, do not remove the black insulator around the optics and cables.

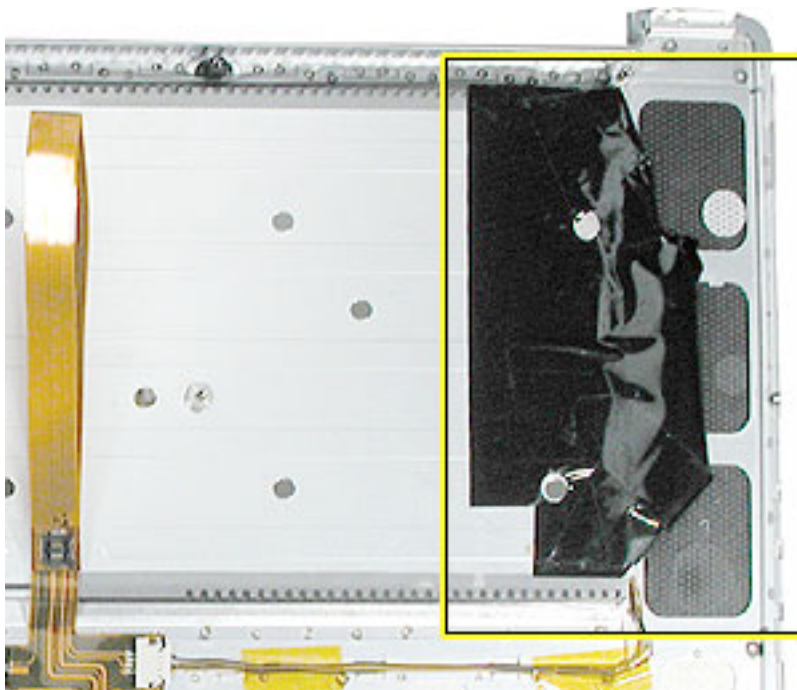

2. Gently pull up on the keyboard flex cable to release the adhesive at its base.

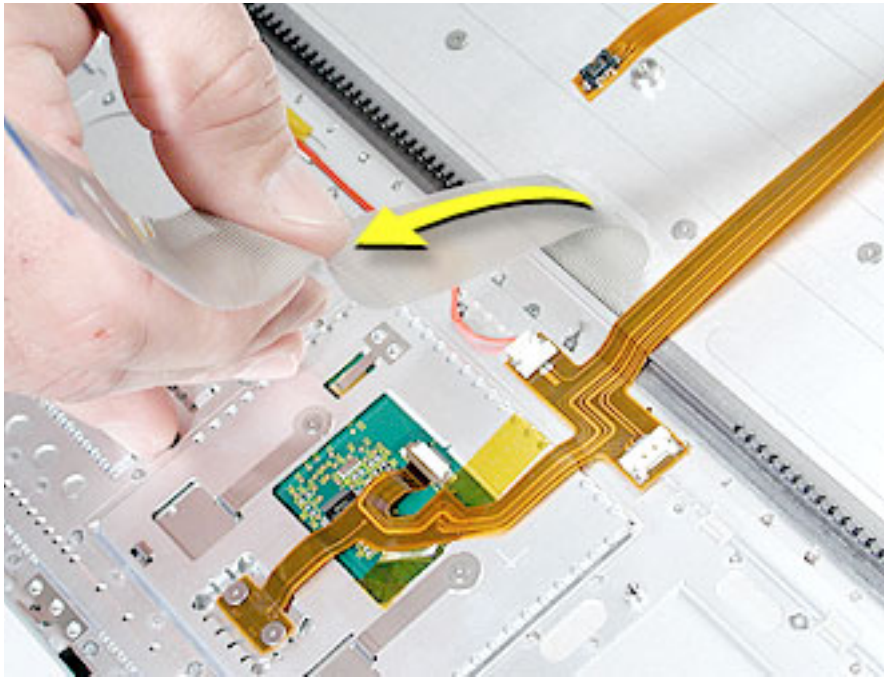

3. Remove the thirteen screws.

**Note:** The non-backlit top case shown.

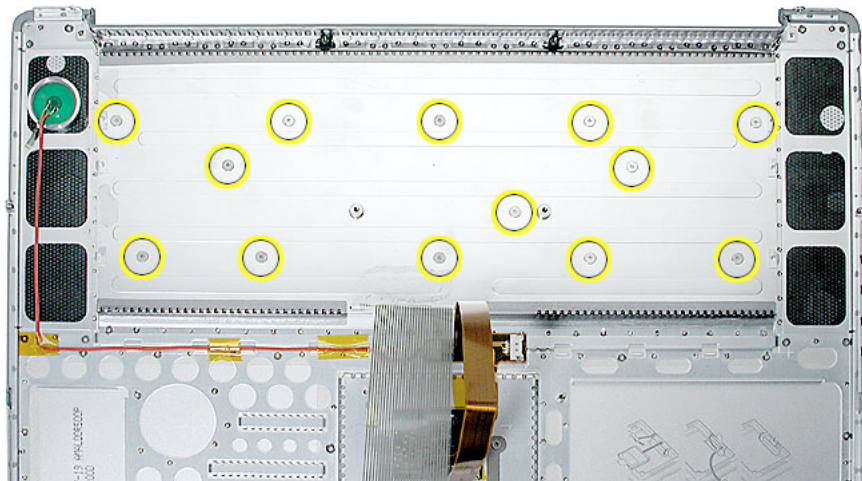



4. Use the pointed end of a black stick and push through the screw hole at the top left side until the keyboard begins to separate from the top case. Work your way along through successive screw holes until a black stick can be inserted under the keyboard from the top.

**Important:** To avoid damaging the screw boss threads, do not use a metal tool.



- Carefully lift up the keyboard and guide out its flex cable (shown below).

**Important:** Be careful not to strain or tear the keyboard flex cable.

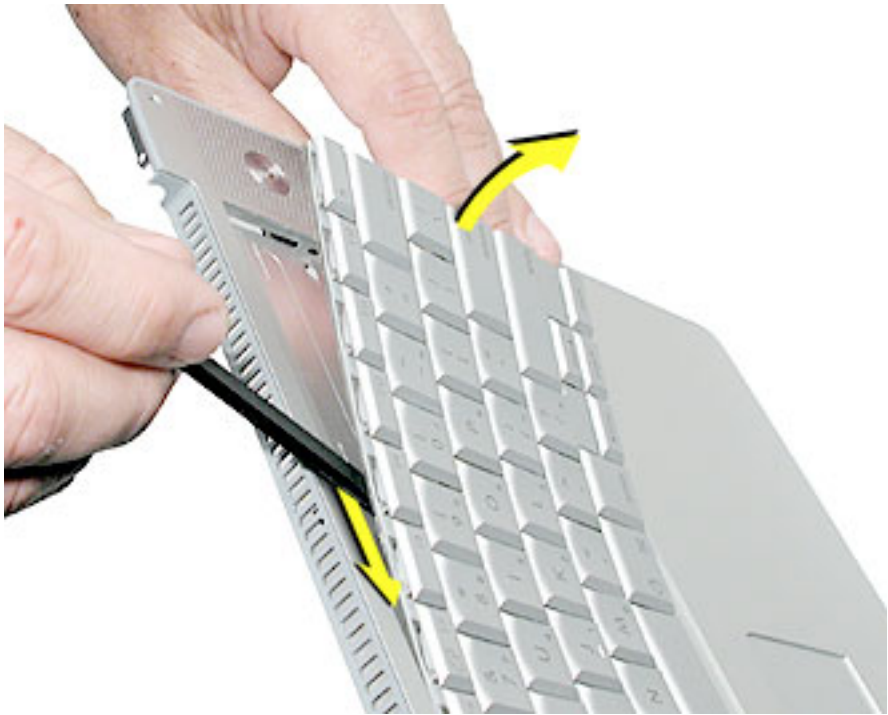

- If adhesive residue is left by the keyboard in the keyboard bay, and on the fiber optics (if present), carefully rub it off.

## Replacement Procedure

1. To install the keyboard or replacement keyboard, insert its flex cable through the slot in the top case and rest the bottom of the keyboard evenly along the bottom edge of the keyboard bay.
2. Remove any protective cover from adhesive strips on the keyboard. While keeping the bottom of the keyboard flush against the bottom of the keyboard bay, rotate the keyboard into place so that the screw bosses fit into the boss holes.



3. Use a black stick to guide the sides of the keyboard into the keyboard well.

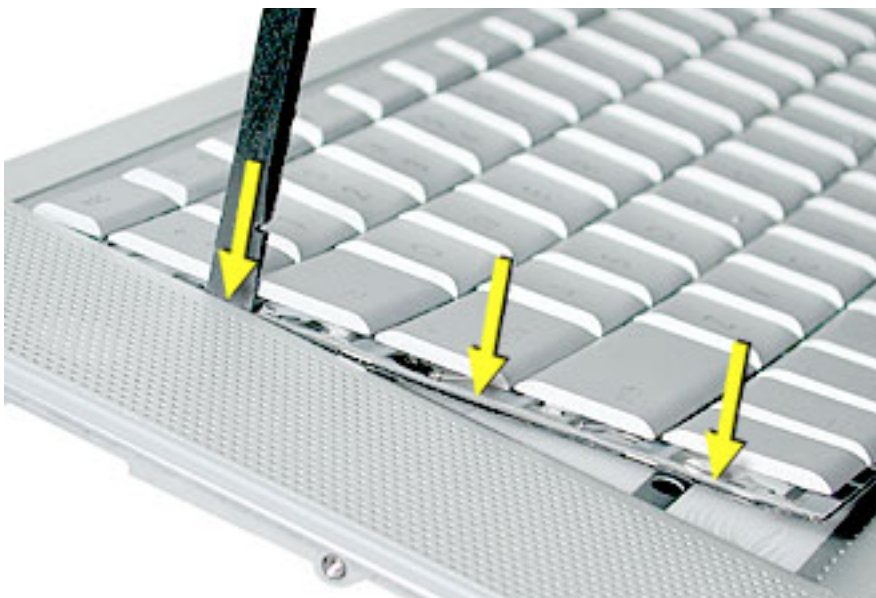

4. Install the keyboard screws in the order shown.

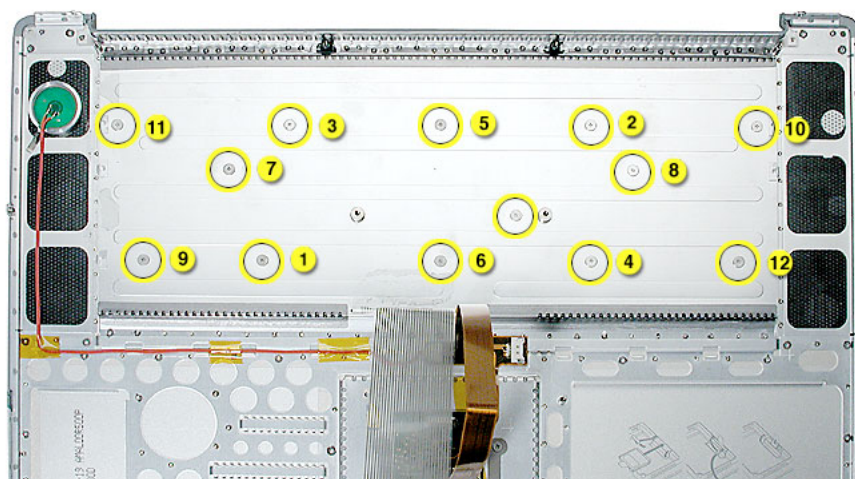

5. Install new or reinstall the insulator film. Remove any protective cover from the adhesive and fit the small round hole in the film over the raised screw boss (one on each side) to start the alignment. Avoid wrinkles or bulges.

On the power button side, run your finger along the film where it folds over the edge of the keyboard bay, to help secure the adhesive and prevent light leakage.

**Important:** The film must be installed and in the same location to protect against contact and electrical shorting in certain areas and to allow contact with the EMI spring on the logic board.

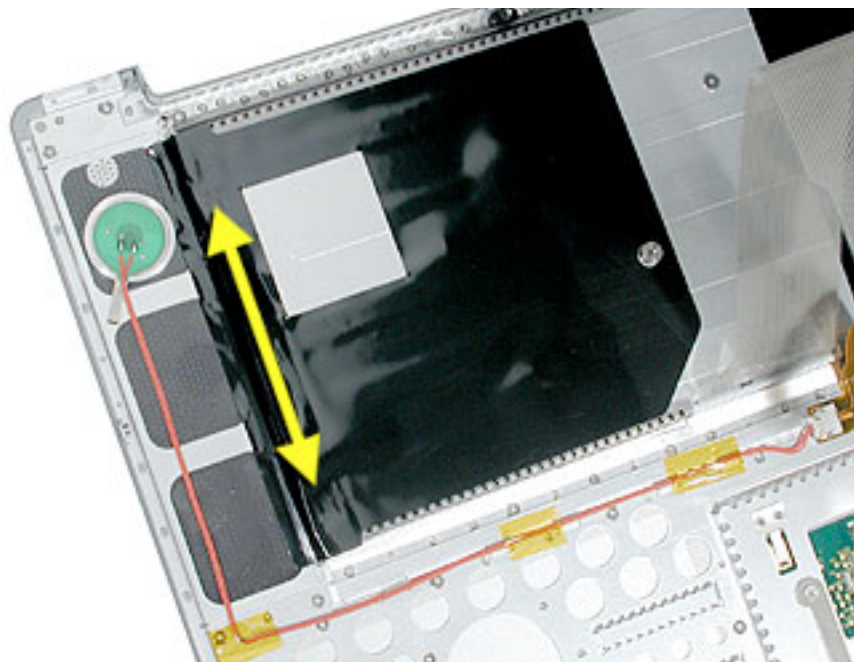

6. To secure the keyboard flex cable, remove any protective cover on the adhesive at the base of the cable. Pull the cable up straight and then forward to lay it flat across the keyboard bay. Run your finger along the base of the flex cable to secure the adhesive.

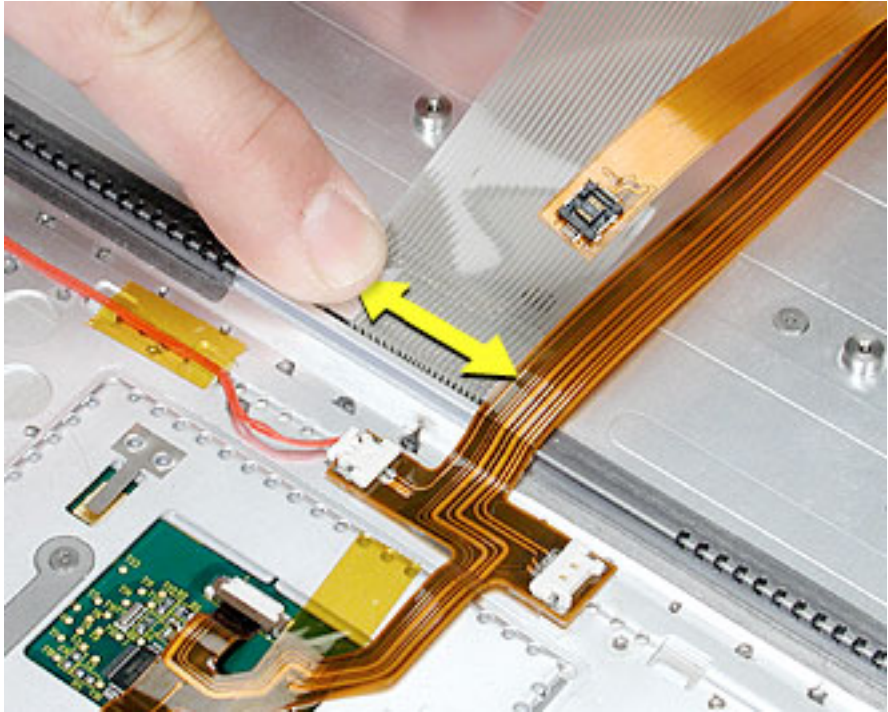

7. Reassemble the computer.
8. Testing the computer should include powering on, checking the keyboard and trackpad function.

If the computer has the optional keyboard backlight feature, operate the computer in a darkened room to check for keyboard backlight function, and light leakage around the perimeter of the keyboard, speaker grill openings and side ports.



# Backup Battery

## Tools

This procedure requires the following tools:

- Black stick (or other nonconductive nylon or plastic flat-blade tool)

## Part Location

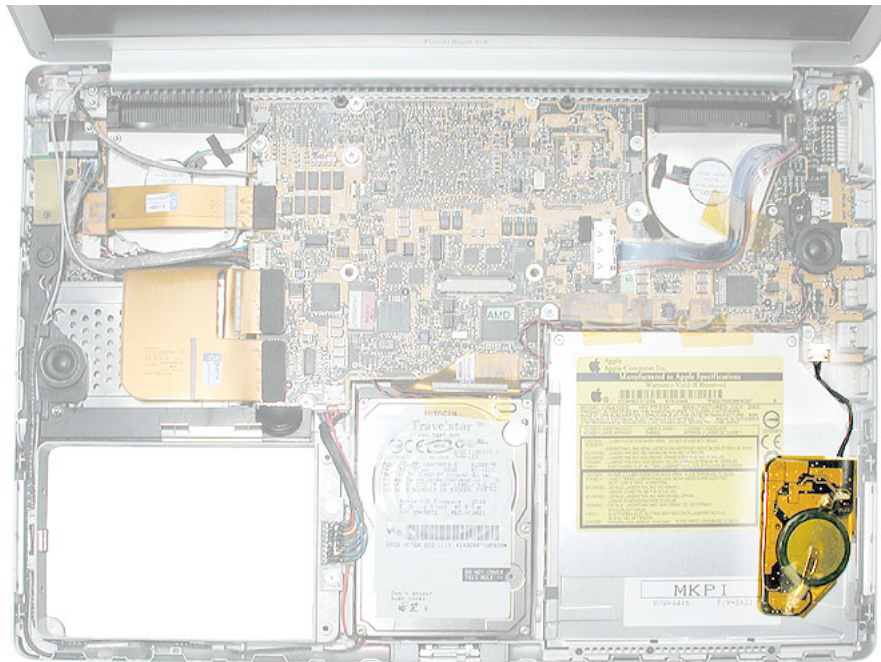

## Preliminary Steps

Before you begin, remove the following:

- Battery
- Top case

## Procedure

1. Use a black stick to release the adhesive holding the backup battery to the optical drive then disconnect the backup battery cable.

**Note:** The backup battery is held down by double-backed tape adhesive on its cover.



## Replacement Procedure

1. Connect the backup battery cable to the backup battery and to the logic board.
2. Remove any protective adhesive cover on the replacement backup battery.
3. Notice the curve of the metal bracket along the right edge of the optical drive. Position the backup battery precisely as shown.

**Important:** If the backup battery is not positioned correctly, sharp edges on the top case over the backup battery may cause damage.





4. Press where shown to secure the backup battery to the optical drive.



5. Reassemble the computer.
6. Testing the computer should include plugging in the power adapter and letting the backup battery charge for half an hour. Then power on the computer and disconnect the power adapter, set the system clock, put the computer to sleep, remove the main battery for five seconds and reinstall. The date and time should not reset.  
Also, insert an optical disc to verify that the optical drive functions properly.



# Optical Drive

## Tools

This procedure requires the following tools:

- #0 Phillips screwdriver (magnetized)
- Thin double-back tape (if the backup battery will not re-stick securely)
- Black stick (or other nonconductive nylon or plastic flat-blade tool)

## Part Location

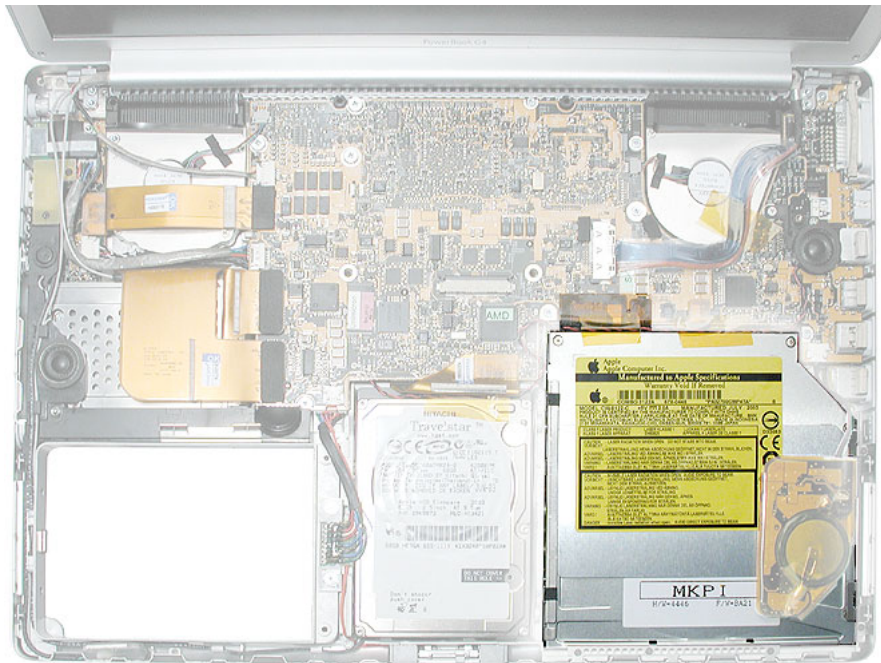

## Preliminary Steps

Before you begin, remove the following:

- Battery
- Top case
- Backup battery

## Procedure

1. Remove the two screws from the drive hold-down bracket.

922-6097



6.4 mm



2. Lift out the bracket.



3. Remove the two screws, shown, then use a black stick, or the connector pull tab if present, to carefully loosen and disconnect the optical drive flex cable connector.

922-6090



3.2 mm



4. Lift up on the optical drive at its rear and remove.



5. Transfer the flex cable, side brackets and screws to the replacement optical drive.

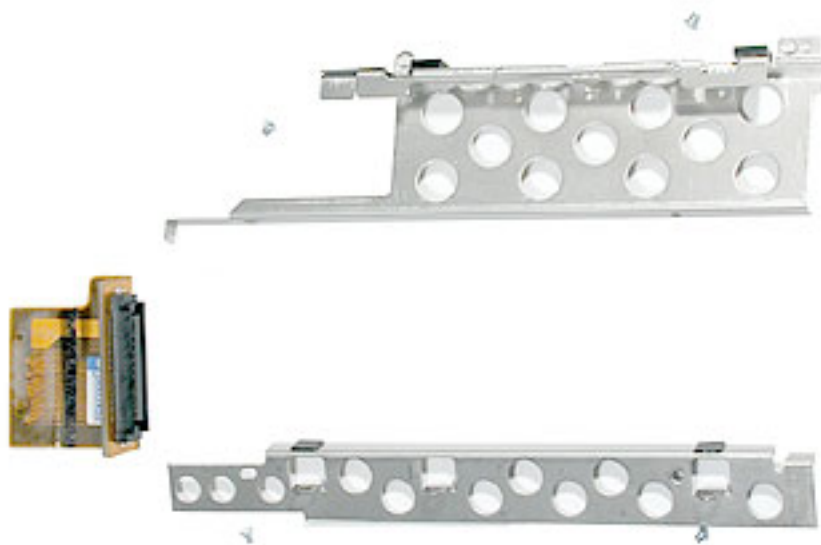
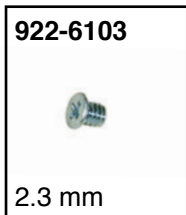

6. To install the replacement optical drive, insert the front of the drive under any overhang at the front of the computer above the optical drive slot, then lower the back of the drive into place.

**Important:** Verify that the front of the drive does not catch above any bracket or overhang at the front of the optical drive bay.



- 
7. Verify that both sides of the drive are fully seated.
  8. Connect the optical drive flex cable connector to the logic board.
  9. Reassemble the computer.
  10. Testing the computer should include powering on, inserting an optical disc and ejecting it to make sure the drive is aligned with the opening and functioning properly.

Test the backup battery by plugging in the power adapter and letting the backup battery charge for half an hour. Then power on the computer and disconnect the power adapter, set the system clock, put the computer to sleep, remove the main battery for five seconds and reinstall. The date and time should not reset.

---

## How to remove a stuck disc from the optical drive

1. Remove the four identical screws that hold the top cover to the drive.

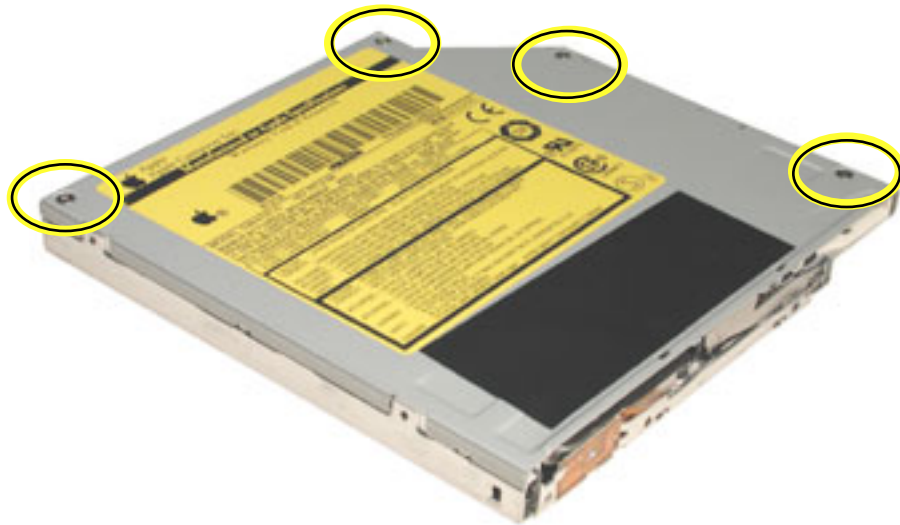

2. Slide the top cover approximately 2 mm toward the back of the drive. Lift up the top cover to remove it.



3. Check the placement of the disc. It is either clamped to the turntable at the center of the disc, or it is wedged under one or more posts at the outer edge of the disc.
4. Holding the edge of the disc, press on the center clamp or hold the posts steady as you remove the disc from the drive.

**Important:** Do not touch any key components located near the disc.



5. Replace the top cover on the drive so that the small hooks on the top cover fit into the slots on the bottom cover. Then slide the top cover into place.



6. Replace the four screws.
7. Install the replacement drive, and reassemble and test the computer.





# Hard Drive

## Tools

This procedure requires the following tools:

- #0 Phillips screwdriver (magnetized)
- Black stick (or other nonconductive nylon or plastic flat-blade tool)

## Part Location

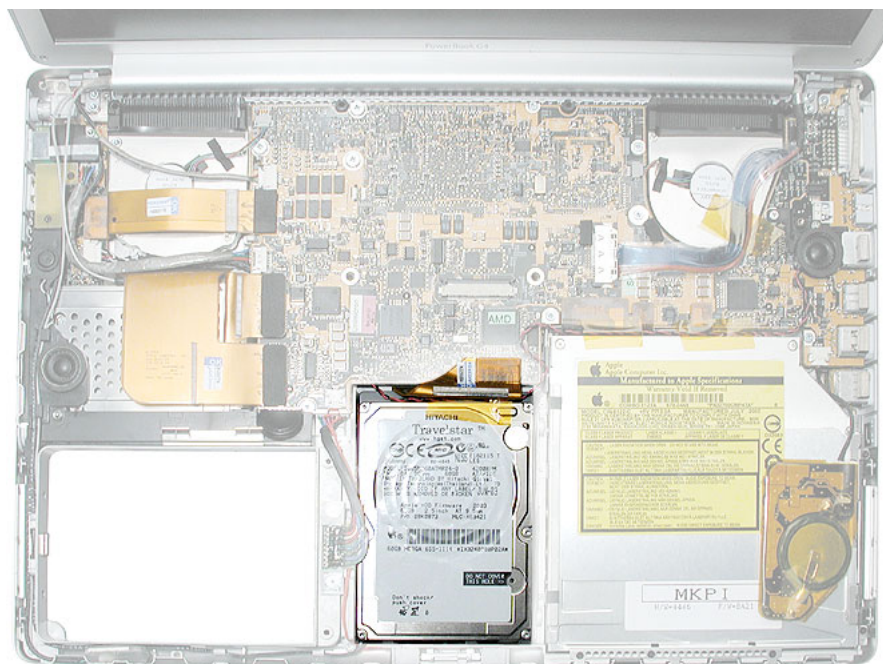

## Preliminary Steps

Before you begin, remove the following:

- Battery
- Top case

## Procedure

1. Remove the two screws from the drive hold-down bracket.

922-6097



6.4 mm



2. Lift out the bracket.



3. Use a black stick, or the connector pull tab if present, to carefully loosen and disconnect the hard drive flex cable connector.
4. Lift up on the right side of the hard drive to remove.

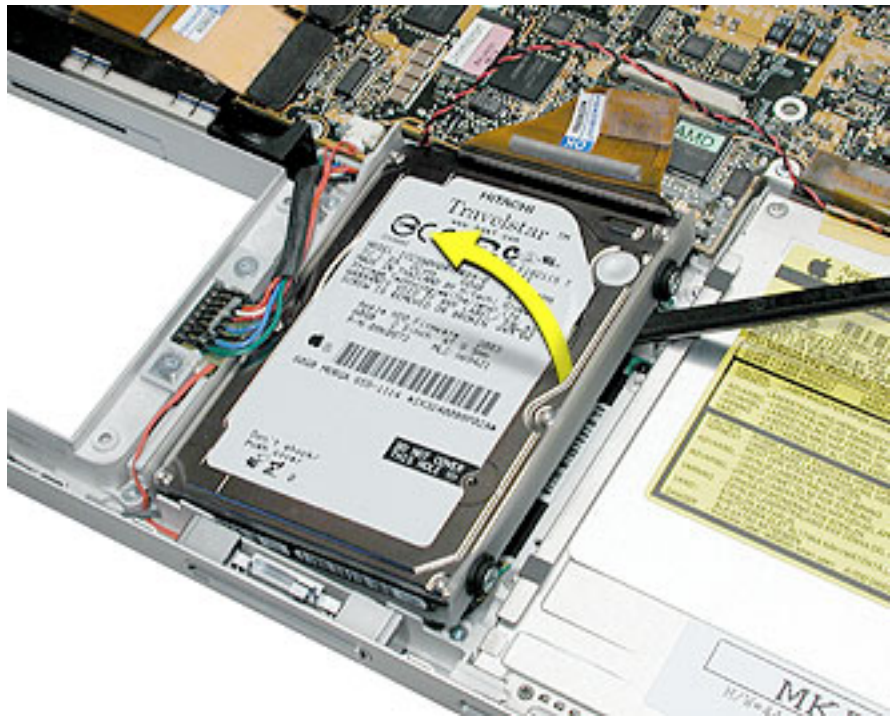

5. Transfer the shield, side screws, rubber shockpads and the flex cable to the replacement hard drive.

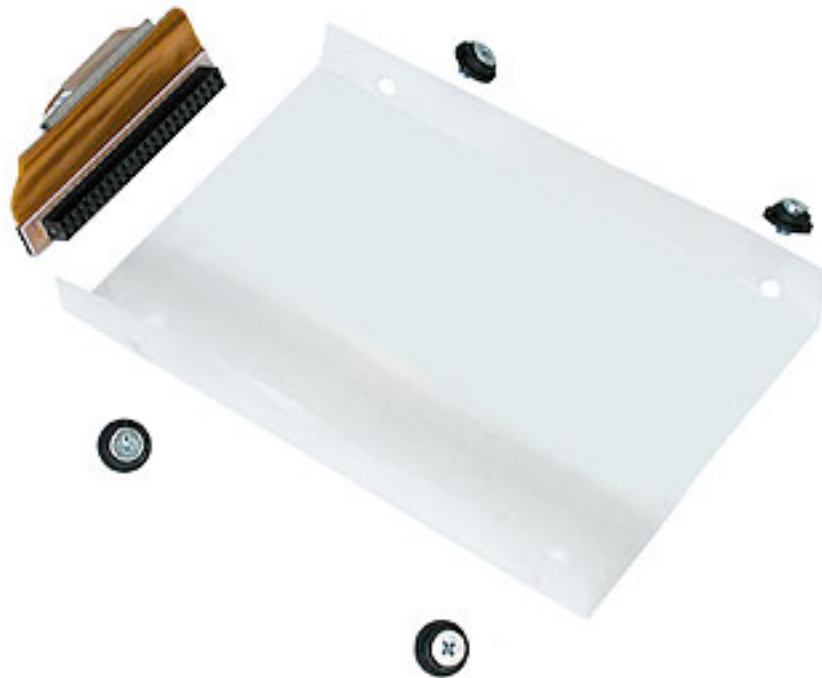

**Note:** If replacing the hard drive flex cable, verify that the EMI pad is installed on the cable, or install it if supplied, or transfer from the replaced cable.

6. Install the replacement hard drive and reassemble the computer.
7. Testing the computer should include powering on, checking that the hard drive is recognized, checking for sound from the speakers and that the modem works.



# Modem

**Note:** The PowerBook G4 (15-inch FW 800) has a larger modem than the PowerBook G4 (15-inch 1.5/1.33GHz). Location, removal and installation for each is very similar, though the flex cable locations and reattachment methods to the modem are different.

## Tools

This procedure requires the following tools:

- #0 Phillips screwdriver (magnetized)
- Black stick (or other nonconductive nylon or plastic flat-blade tool)

## Part Location

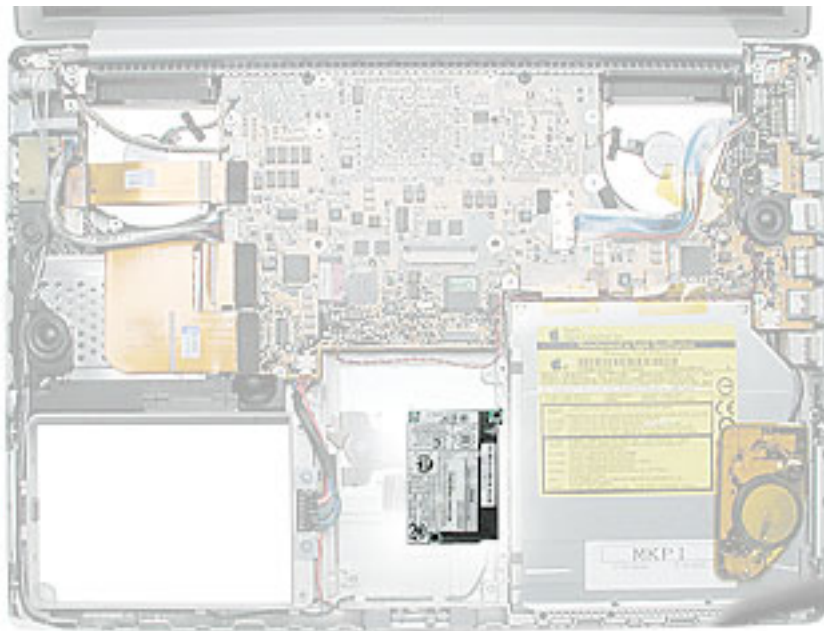

## Preliminary Steps

Before you begin, remove the following:

- Battery
- Top case
- Hard drive

## Procedure

1. Remove the two screws

**Note:** The PowerBook G4 (15-inch FW 800) modem shown. The PowerBook G4 (15-inch 1.5/1.33GHz) modem looks slightly different and its two screws are in different locations.

922-6090



3.2 mm

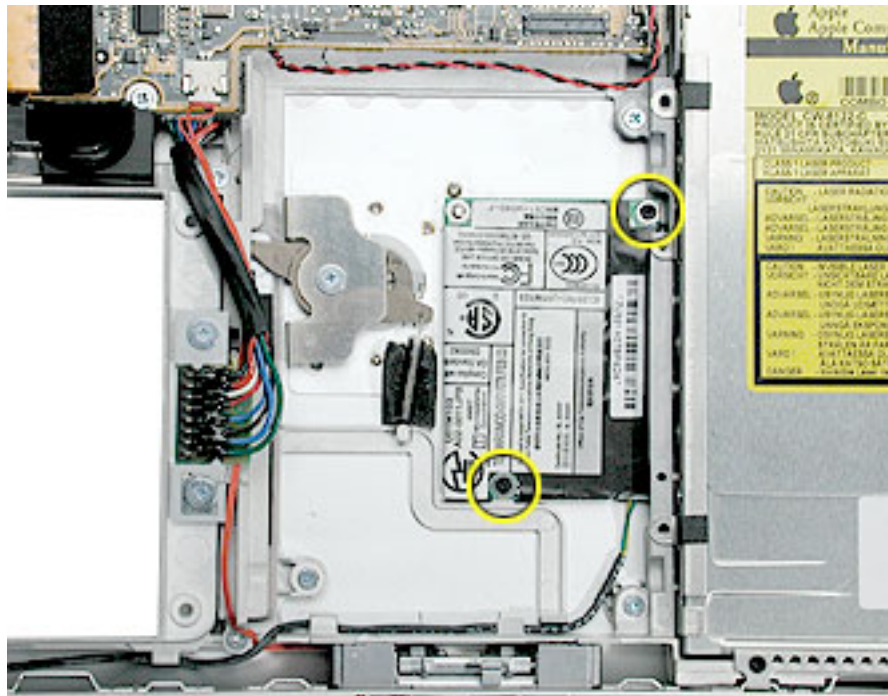

2. Disconnect the flex cable and RJ-11 cable. (see computer heading for proper procedure):

**PowerBook G4 (15-inch FW 800):**

- Carefully lift the modem to disconnect the flex cable connected underneath.

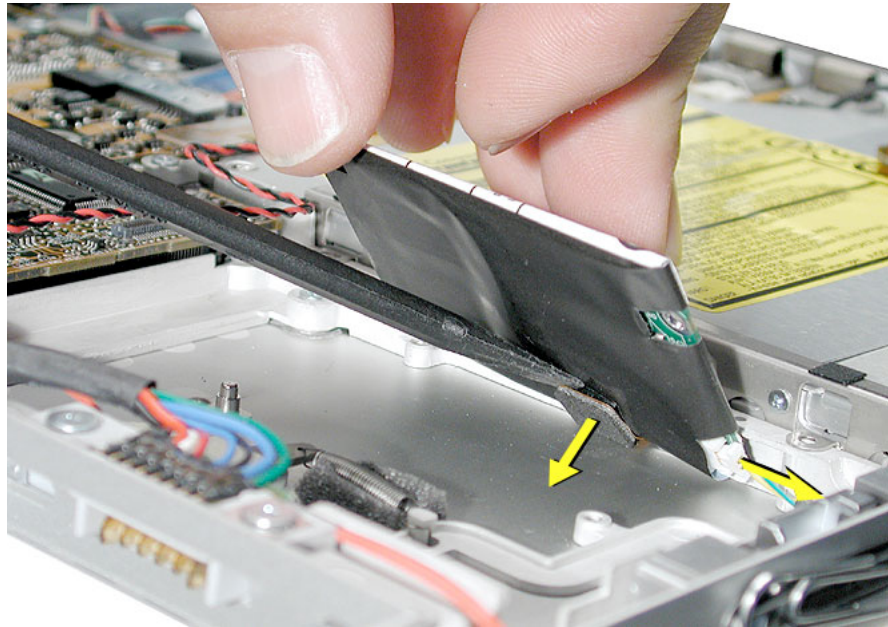

- Lift the modem up slightly and disconnect the RJ-11 cable connector.



**PowerBook G4 (15-inch 1.5/1.33GHz):**

- Carefully lift the modem to disconnect the flex cable connected underneath.

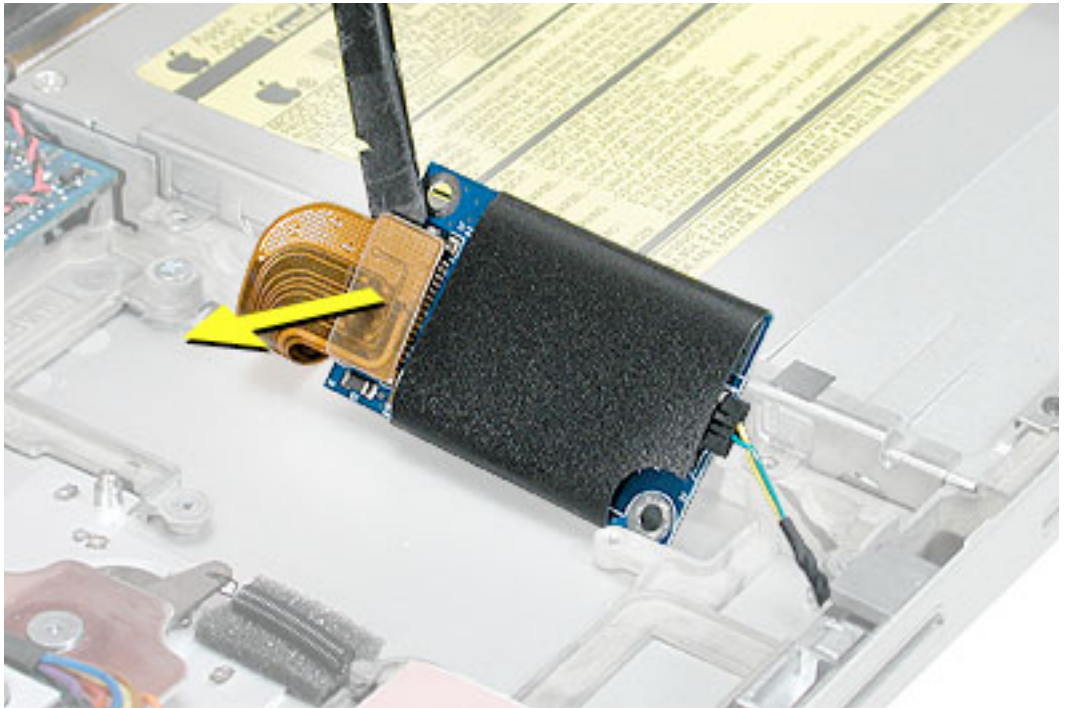

- Firmly grasp and pull the connector and wires to disconnect the RJ-11 cable connector.

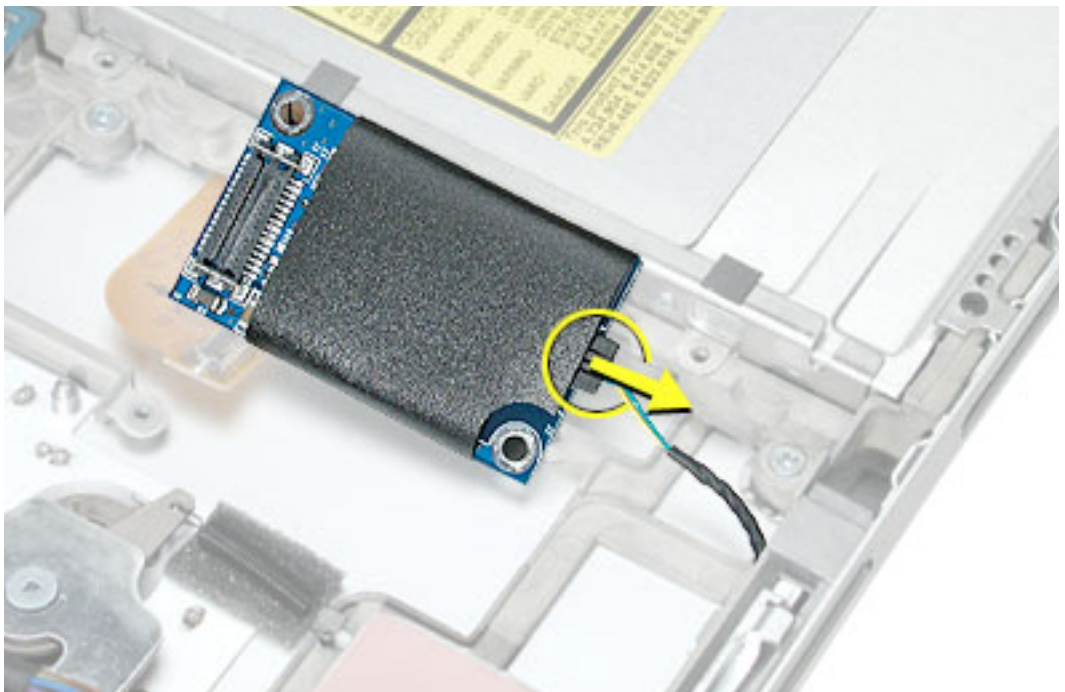



## Replacement Procedure

1. Connect the RJ-11 cable to the modem.
2. Verify that the modem RJ-11 cable is routed as shown.

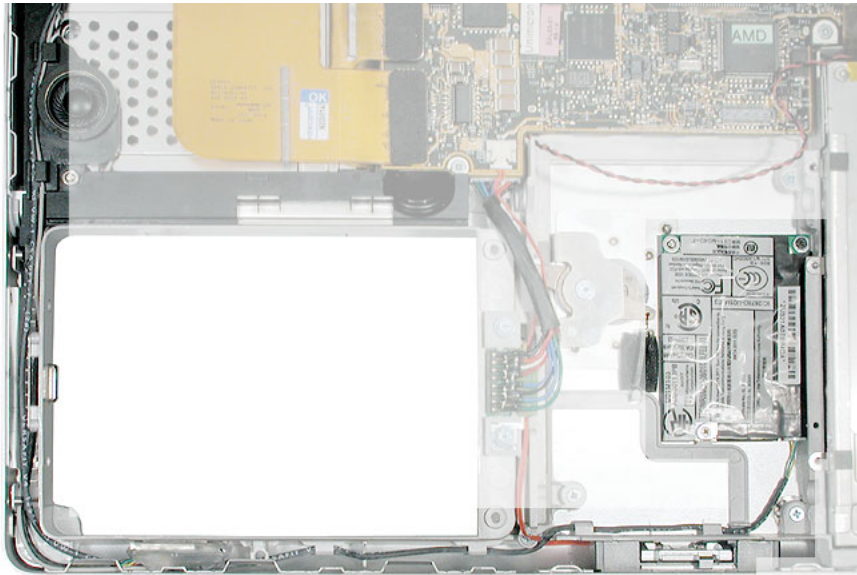

### PowerBook G4 (15-inch FW 800):

- Position the modem over the pin and align the screw holes, then press down over the flex connector location to connect the cable.
- **Note:** If the modem will not seat on the flex connector, remove the optical drive to gain access to the cable.
- Check that the modem cable is still secured to the modem.



**PowerBook G4 (15-inch 1.5/1.33GHz):**

- Press the flex connector and socket together with your fingers to secure.

**Important:** After the modem has been laid flat, do not press down on the middle of the modem board, or damage to the board can result.

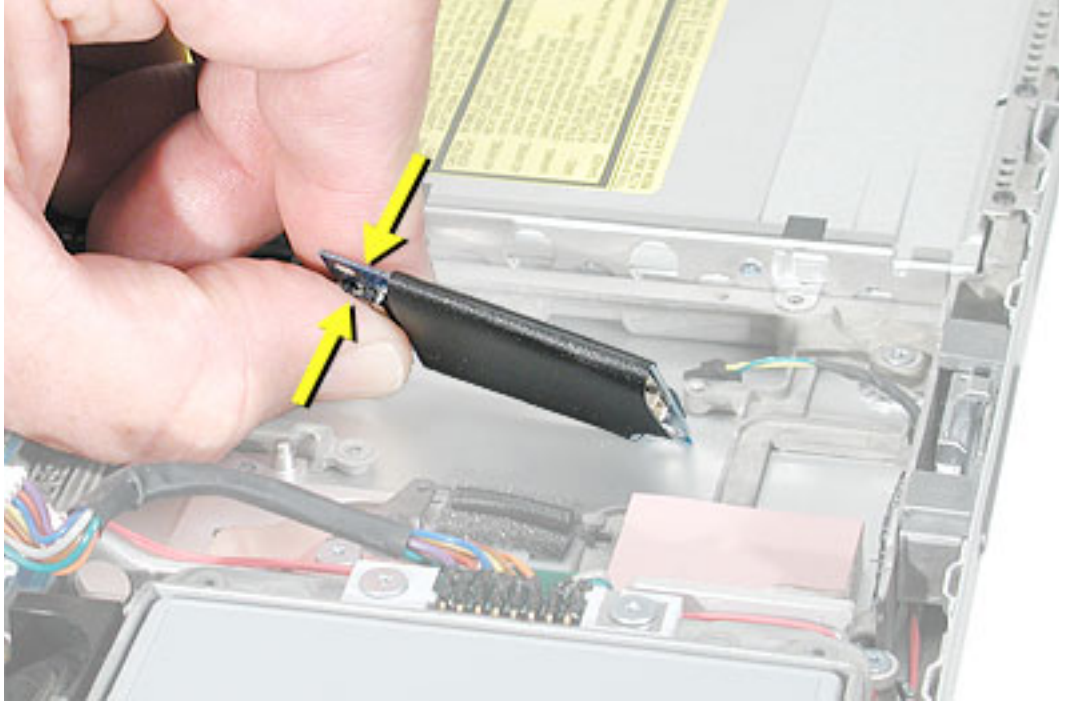

3. Reinstall the modem screws then reassemble the computer and test the modem. Check the battery latch to make sure nothing is interfering with its rotation.



# Bluetooth

## Tools

This procedure requires the following tools:

- Black stick (or other nonconductive nylon or plastic flat-blade tool)

## Part Location

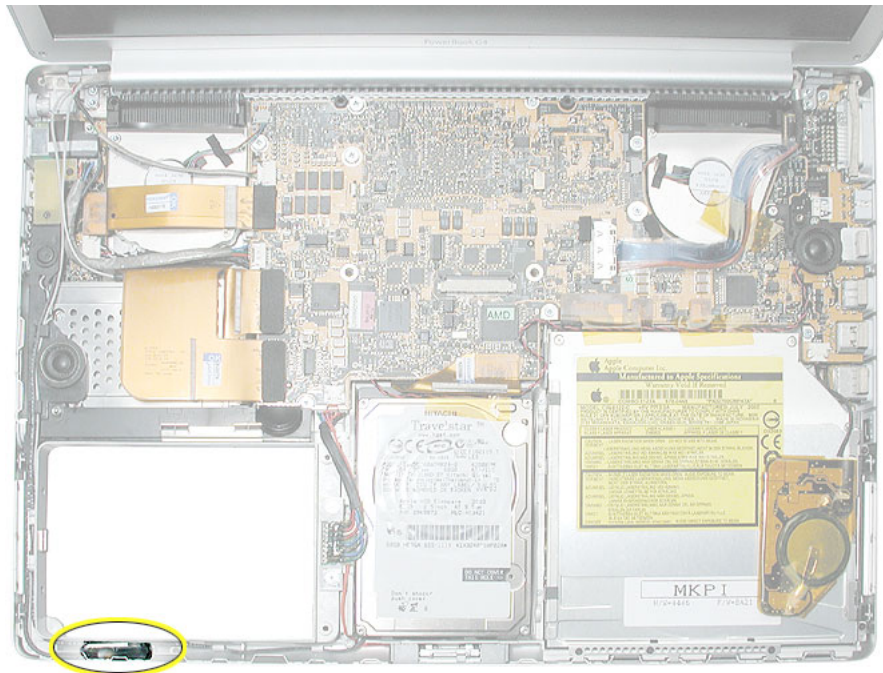

## Preliminary Steps

Before you begin, remove the following:

- Battery
- Top case

**Note:** Replacing the Bluetooth cable requires removing the Sound/DC-in board.

## Procedure

1. Guide the Bluetooth 4-pin connector and antenna cables from under the bottom case hardware.
2. Lift up the Bluetooth board.



3. Disconnect the Bluetooth antenna cable.
4. Use a black stick to disconnect the 4-pin connector.

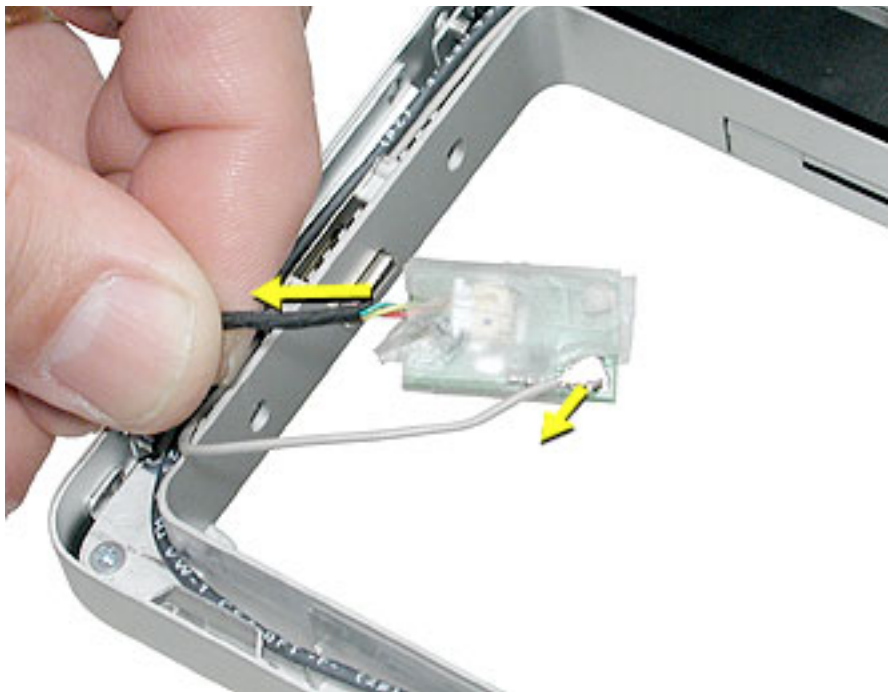

5. If replacing the Bluetooth cable, remove the cable through the space at the PC card cage button guide.

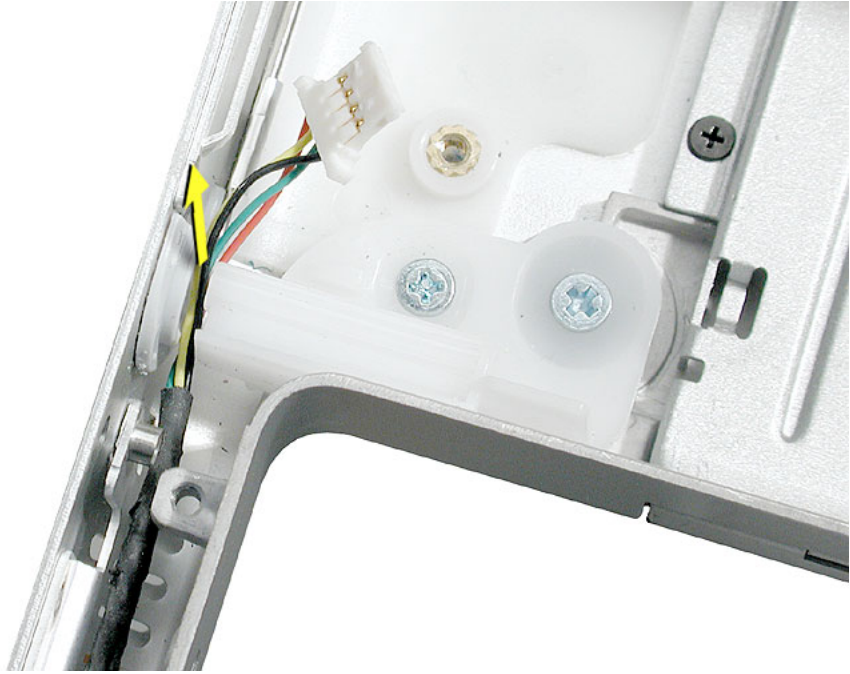

6. Install the replacement Bluetooth board.

**Note:** Use Kapton tape if needed to secure the shield around the board.

7. Route cables under the case hardware in the channel as shown, and verify that the antenna cable is seated in the cable clips on the speaker assembly.

**Note:** The Bluetooth antenna cable secures with the modem cable in the channels along the left speaker. If re-securing, insert the Bluetooth antenna wire into the channel first, then the modem wire.

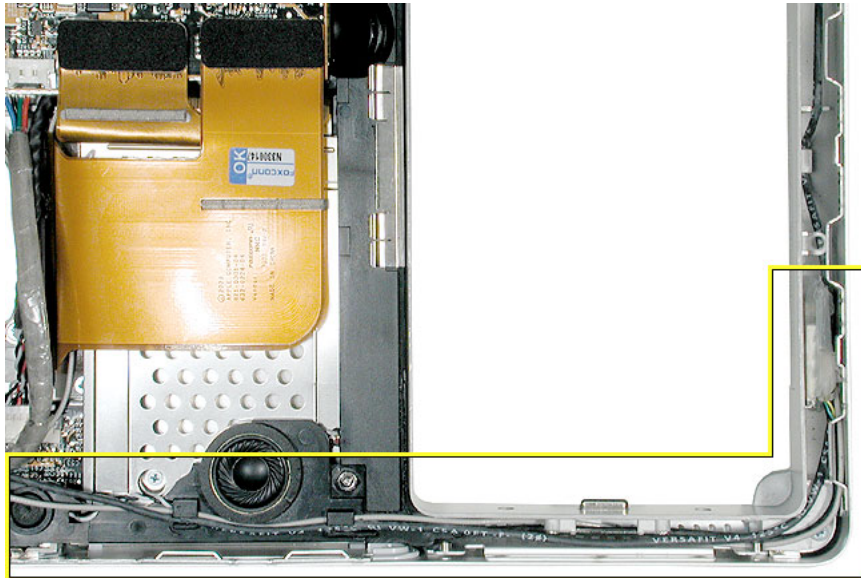

**Important:** Check that cables are not routed between screw bosses or over case edge hardware.

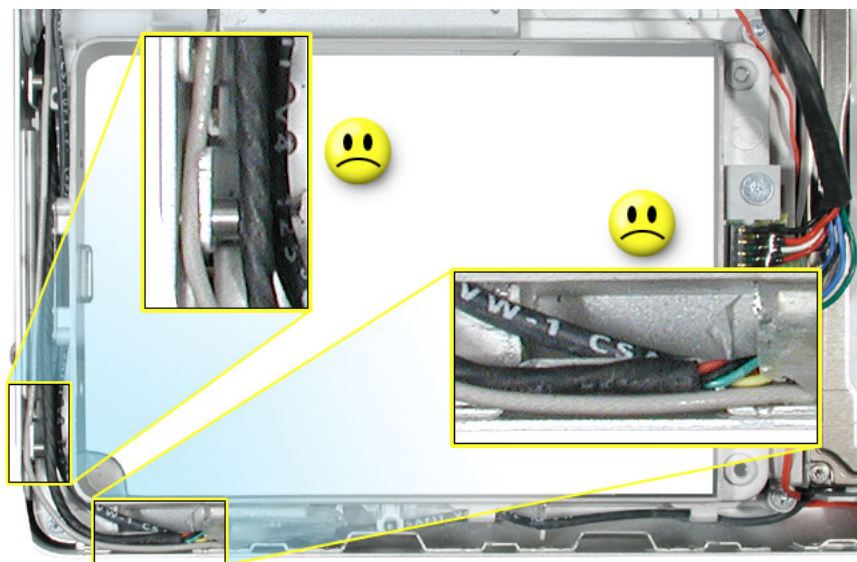

8. Reassemble and test the computer. Testing should include using Bluetooth to connect to another computer.



# Left Blower

## Tools

This procedure requires the following tools:

- #1 Phillips screwdriver (magnetized)
- Black stick (or other nonconductive nylon or plastic flat-blade tool)

## Part Location

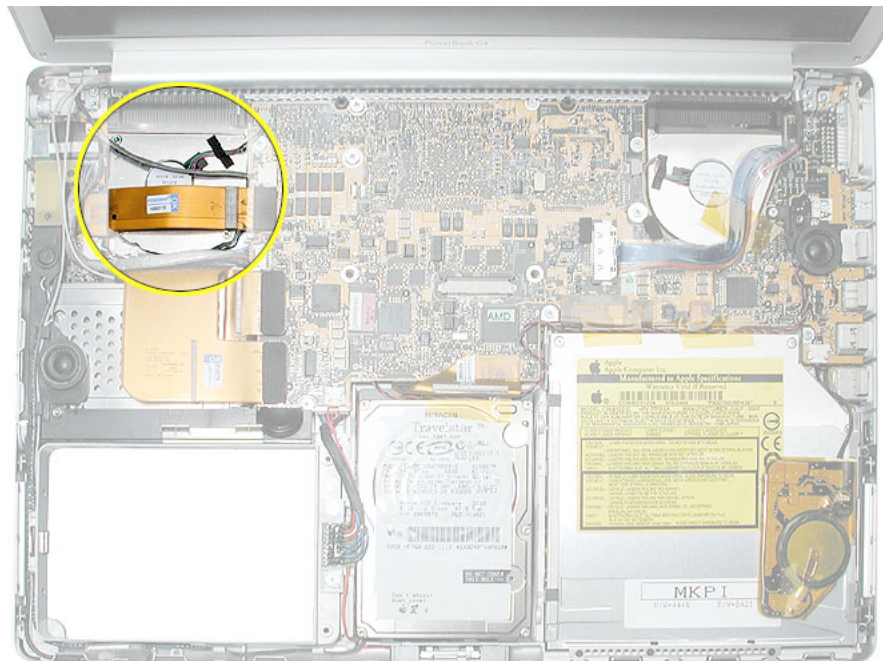

## Preliminary Steps

Before you begin, remove the following:

- Battery
- Top case

**Note:** Replacing the right blower requires removing the logic board.

## Procedure

1. Disconnect the cables shown below.

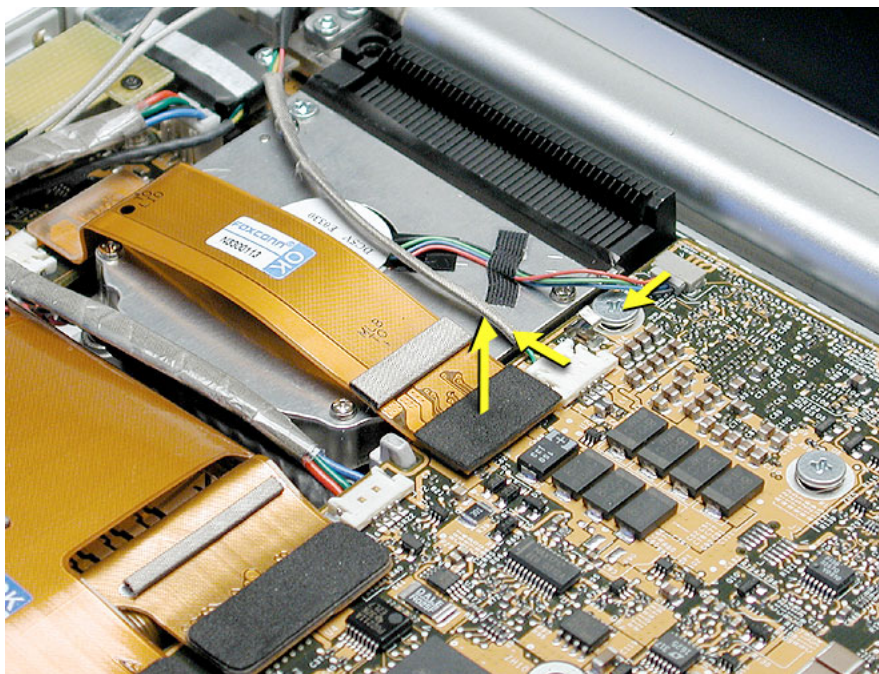

2. Remove four screws.

922-6093



4.5 mm

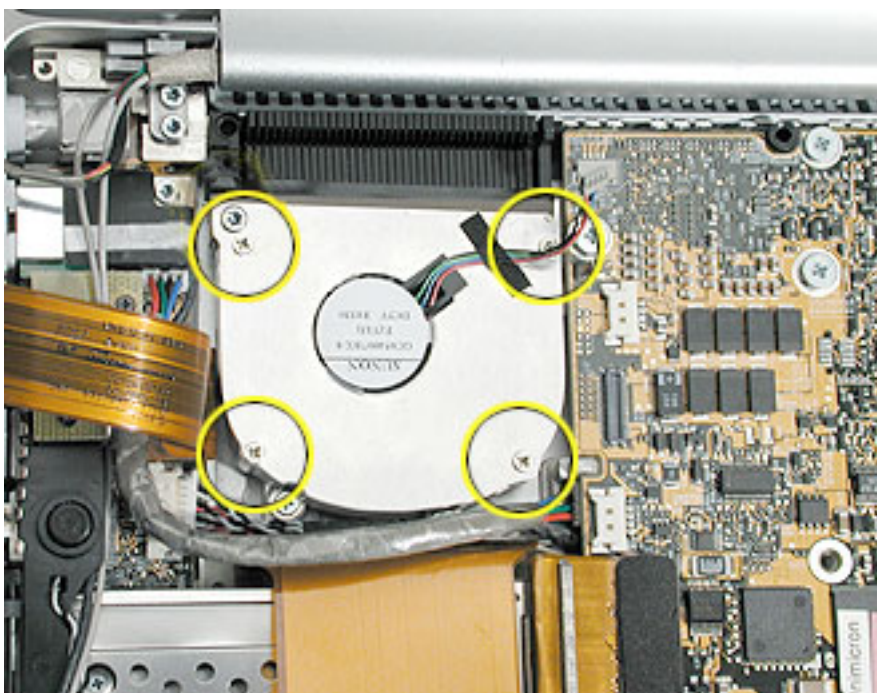



3. Lift out the blower.
4. Install replacement blower. Reassemble and test computer.

**Replacement Note:** Make sure to reseal the tape strip along the edge of the blower.

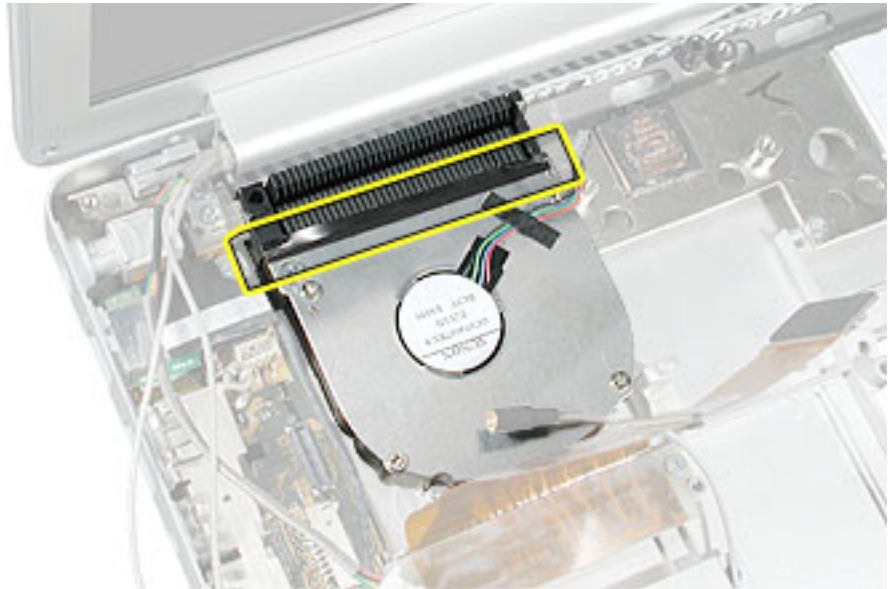



# Ambient Light Sensor Boards

## Tools

This procedure requires the following tools:

- #0 Phillips screwdriver
- Torx T8 screwdriver
- Black stick (or other nonconductive nylon or plastic flat-blade tool)

## Part Location

Computers with the backlit keyboard configuration, only, have a left and a right ambient light sensor installed.

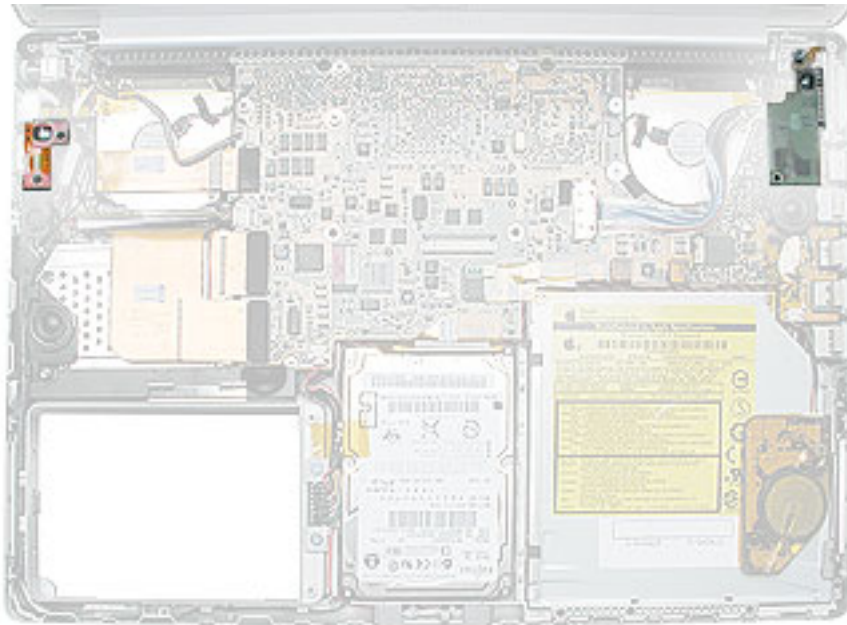

## Preliminary Steps

Before you begin, remove the following:

- Battery
- Top case

## Procedure

1. To remove the left ambient light sensor board, remove the two screws, and disconnect the connector from the logic board.

922-6090



3.2 mm

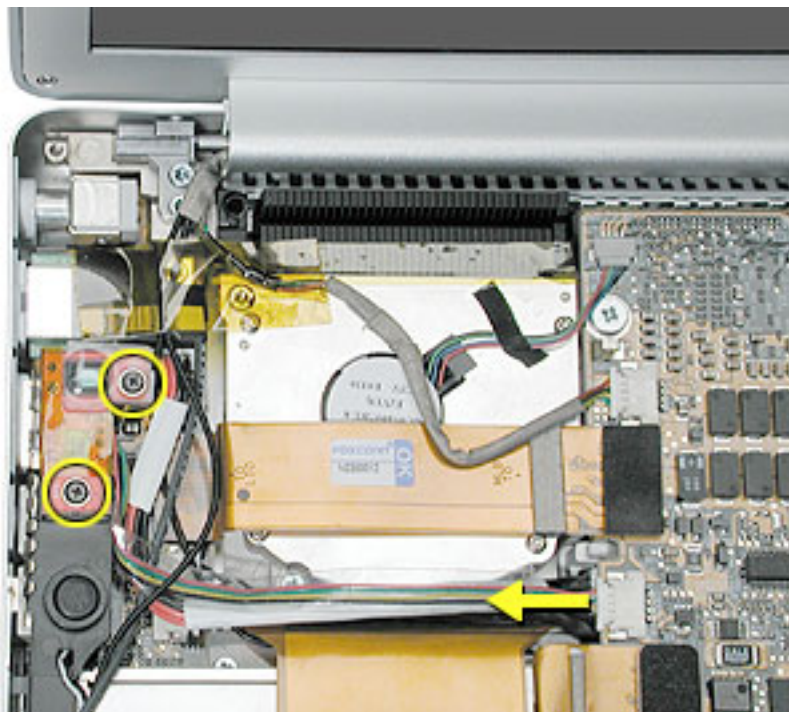

2. To remove the right ambient light sensor, remove the two screws, then lift up on the ambient light sensor board to disconnect it from the logic board (the connector is on the bottom of the board).

**Note:** The sensor assembly consists of two pieces: the sensor board and a lens cover.

922-6475



9.5 mm

922-6090



3.2 mm

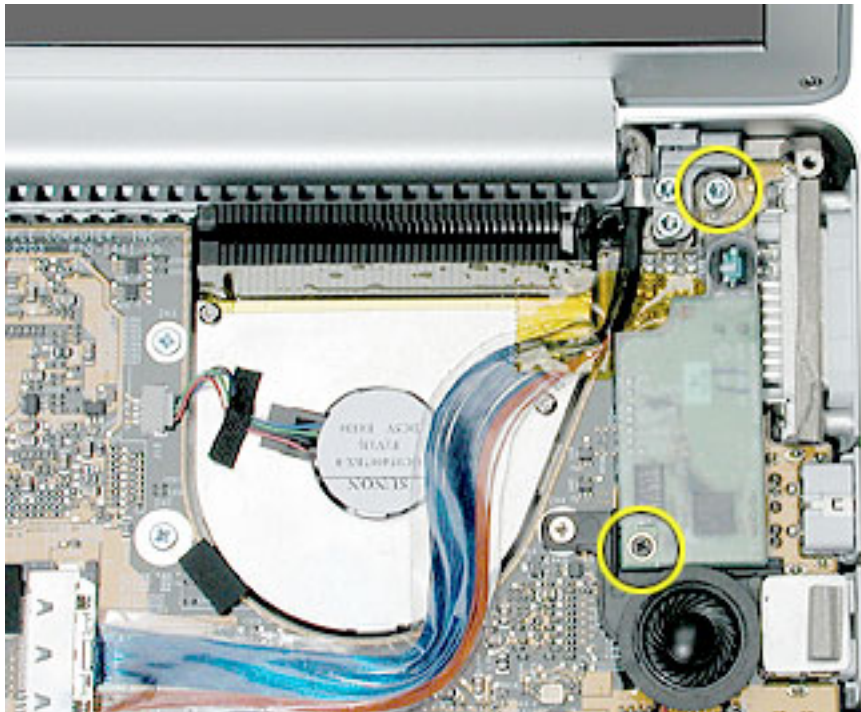

**Replacement Note:** Assemble the replacement sensor board and lens cover before installation.



3. Press, where shown here, to secure the right ambient light sensor board connector to the logic board.



4. Reassemble and test the computer.



# Display Panel Assembly

## Tools

This procedure requires the following tools:

- Torx T8 screwdriver (magnetized)
- #0 Phillips screwdriver (magnetized)
- Black stick (or other nonconductive nylon or plastic flat-blade tool)

## Part Location



## Preliminary Steps

Before you begin, remove the following:

- Battery
- Top case

## Procedure

1. Remove the two screws along the back, closest to the bottom of the computer.

922-6100



5.3 mm



2. Open the computer display.
3. Lift the Bluetooth antenna cable out of the channels on the left speaker, then disconnect the antenna cable from the Bluetooth board.

**Replacement Note:** The Bluetooth antenna cable secures with the modem cable in the channels along the left speaker. When re-securing, insert the Bluetooth antenna wire into the channel first, then the modem wire.

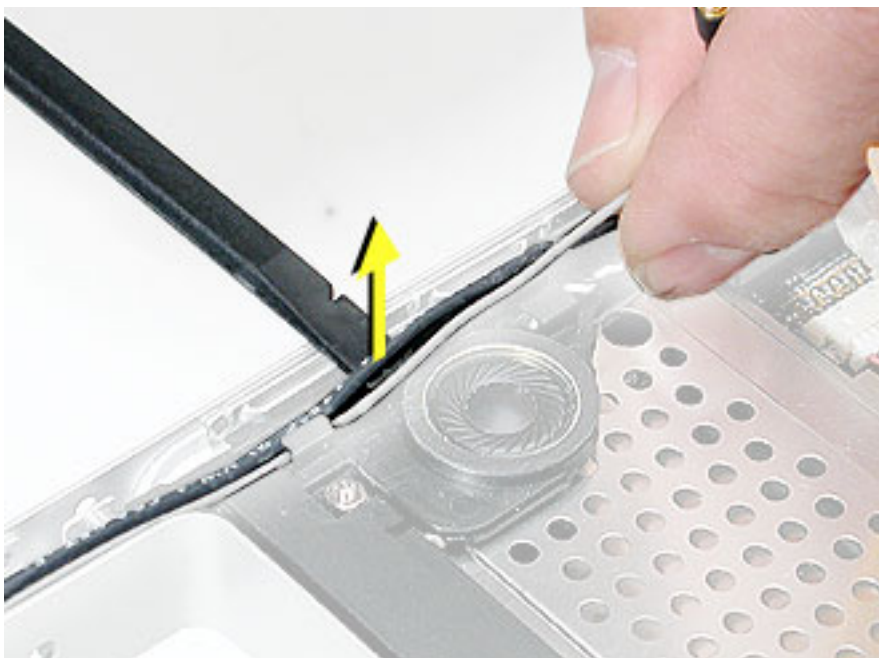

4. Disconnect and lift up the AirPort Extreme flex cable to uncover the AirPort Extreme antenna coupling. Remove Kapton tape if present, then grasp the coupling (not the wires) at both ends and pull to separate at the middle.

**Replacement Note:** Use Kapton tape to secure the connector.

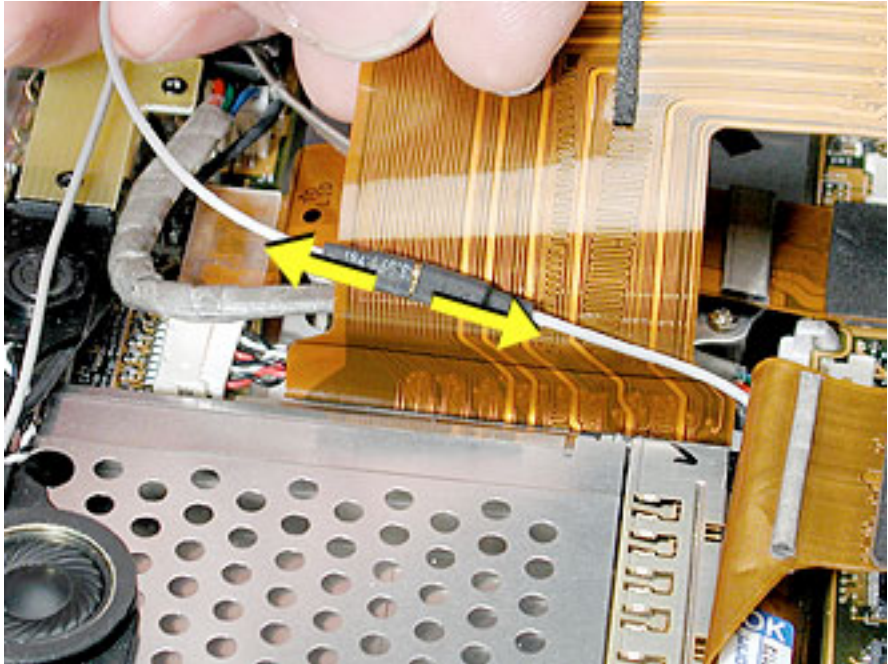

5. Disconnect the inverter cable.

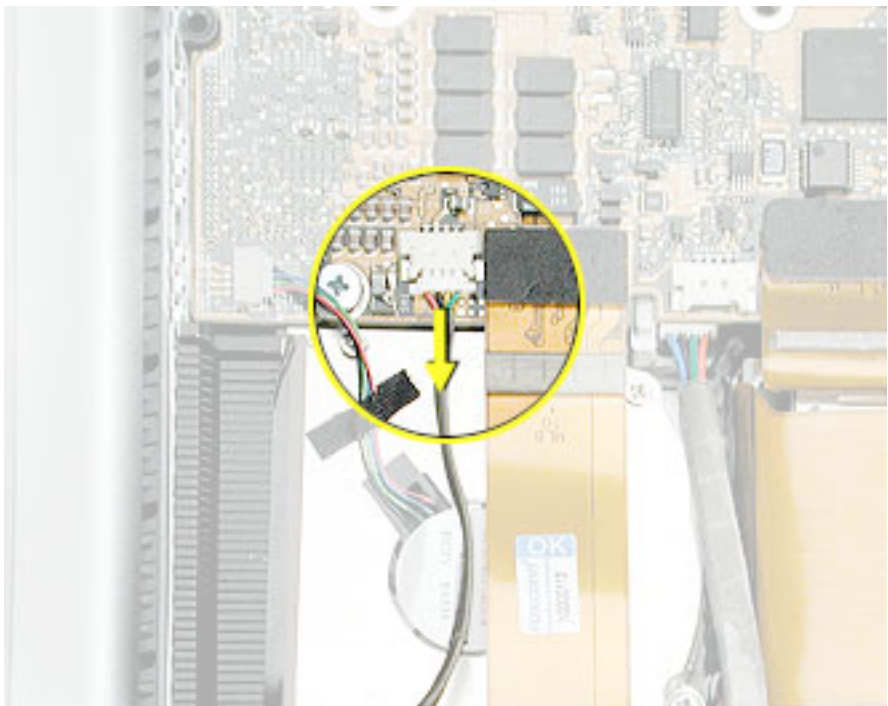



6. On the right side of the computer, disconnect the LVDS cable.

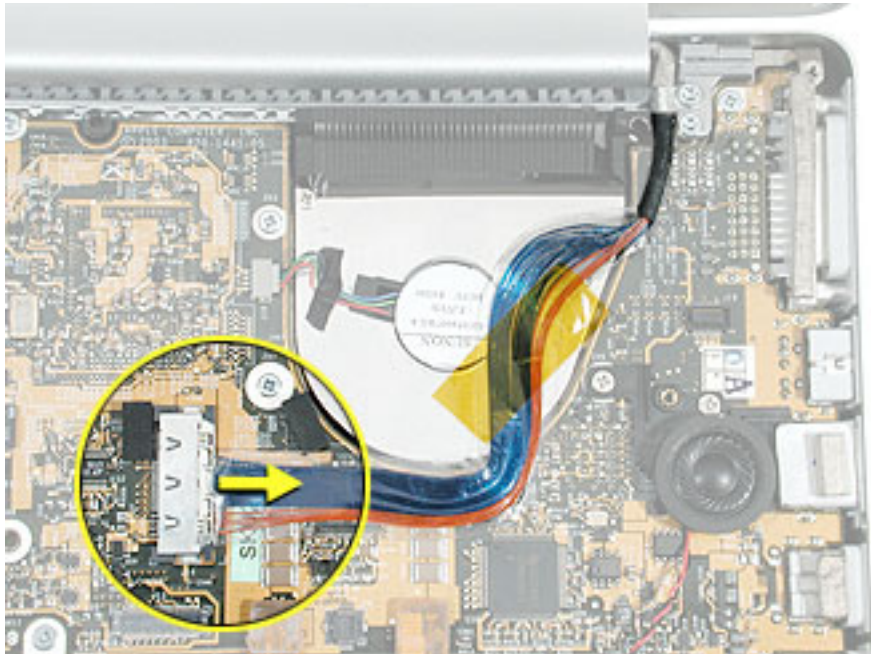

7. Move the display to a 90-degree angle and remove the four screws.

**Important:** Support the display from falling over before removing the last screw.

922-6471



10.25 mm

922-6098



13 mm

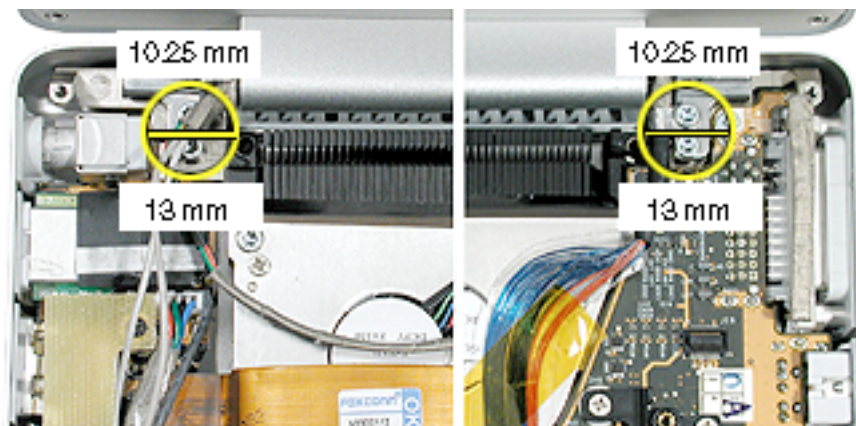

- Lift the display straight up and off of the computer without catching wires.

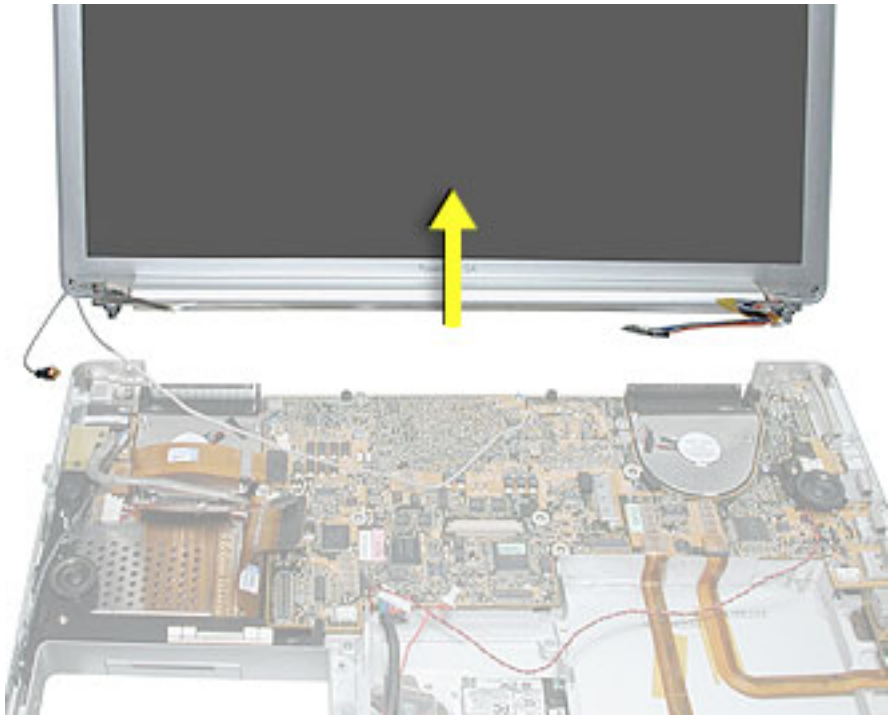

- Install the replacement display panel assembly.

**Replacement Note:** Make sure to capture the grounding loop with the back screw.

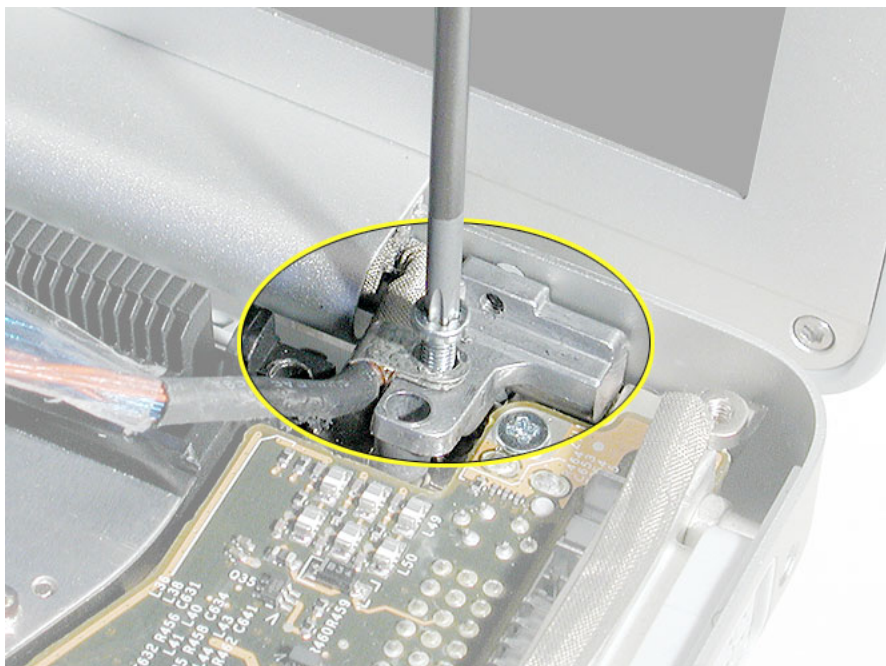

- 
10. Reassemble and test the computer.
  11. Testing the computer should include the display panel. Use Bluetooth to connect to another computer and verify proper AirPort Extreme function. Check the function of the RJ-11 modem port.



# Logic Board

## Tools

This procedure requires the following tools:

- #1 Phillips screwdriver (magnetized)
- 1600 watt hair dryer
- EMI Gasket Kit (076-1057), if gaskets not included with replacement logic board
- Black stick (or other nonconductive nylon or plastic flat-blade tool)
- Alcohol pads

If not ordering a replacement logic board, order:

- Thermal paste (922-6495) – 1.5 GHz & 1.33GHz logic boards (included with boards)
- Thermal Pad Kit (076-1055) – if not ordering a heatsink (included with heatsink)

**Note:** To organize the screws you remove from the computer, use a tray with divided compartments (such as a plastic ice cube tray).

## Part Location

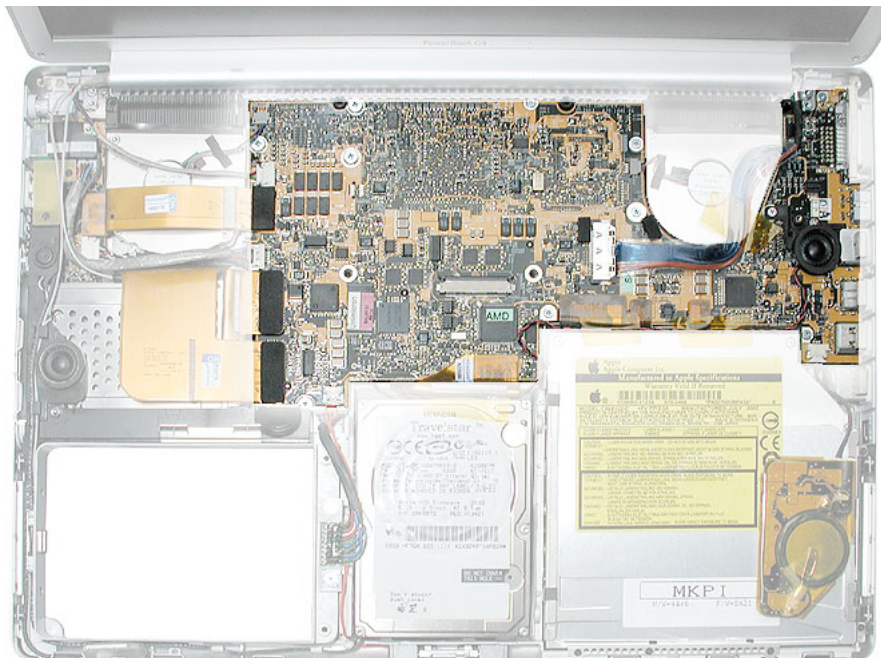

## Preliminary Steps

Before you begin, run the computer until warm (if possible) to help soften the thermal material on the logic board, then shut it down and remove the following:

- Battery
- Top case
- Right ambient light sensor board and lens cover, if present
- Display panel assembly – **Note:** Only need to remove if the hair dryer heating procedure needs to be performed.

**Note:** It may be helpful to remove the optical drive and hard drive to reduce the number of cables to control when replacing the logic board, if desired.

## Procedure

**Warning: Flexing of the logic board can break solder joints to parts. Guard against flexing, to prevent damage to the board.**

1. Disconnect the cables shown.

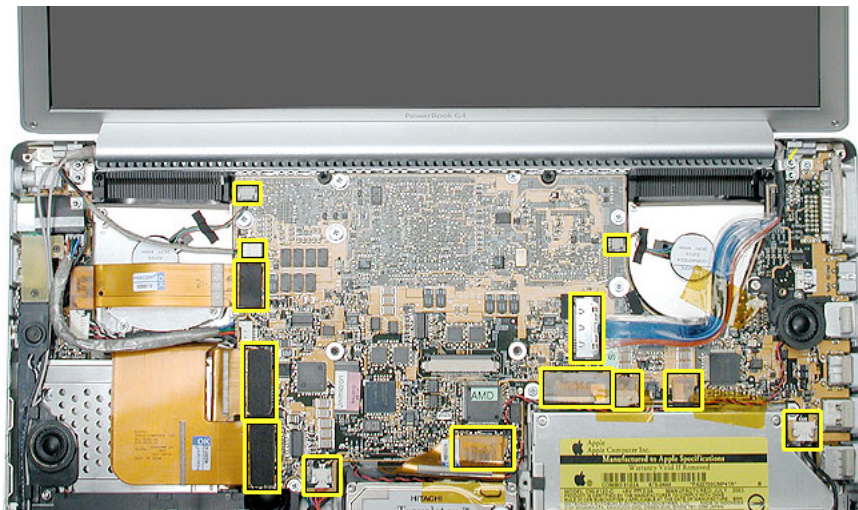

2. Remove the two screws holding the right speaker and move the speaker and its wires down and away from the logic board.

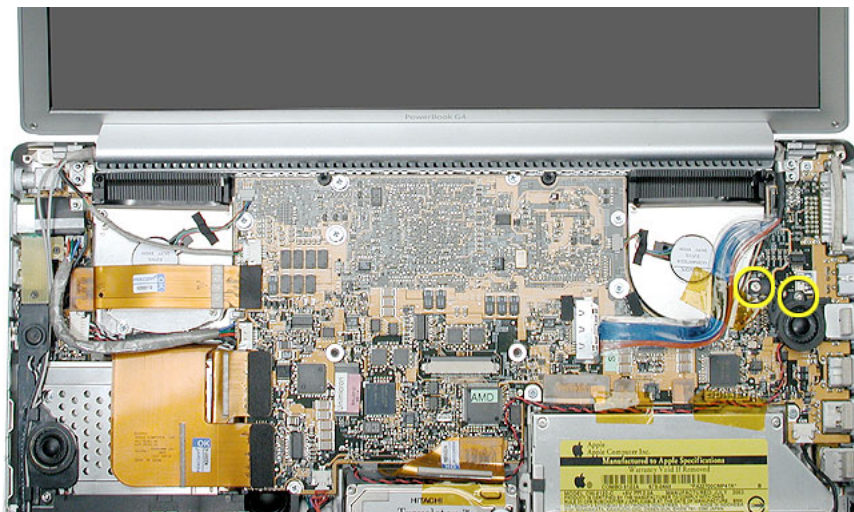

3. Remove the logic board screws, shown.

**Note:** If a right ambient light sensor board was removed, that procedure already removed the upper right logic board screw.

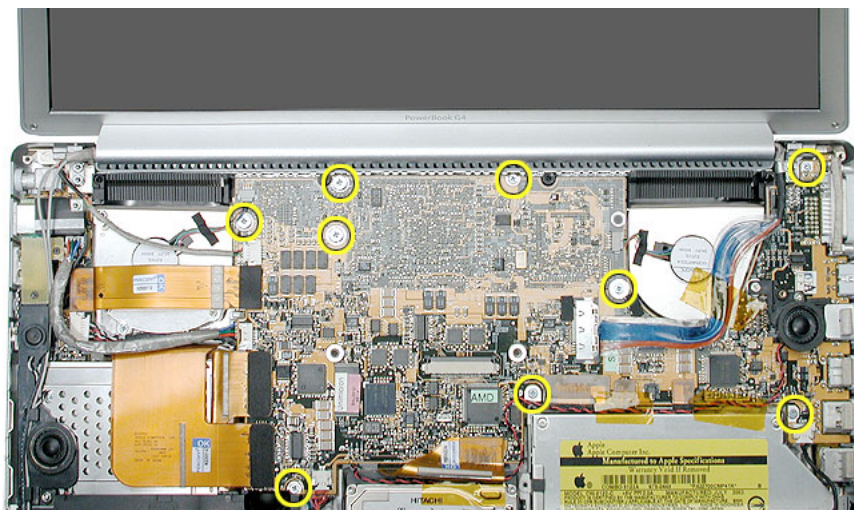

4. **Important:** To prevent damage to the logic board chips, the thermal material between the logic board and the heatsink must be softened before removing the logic board.

If the computer was run before disassembly, and is still warm, you do not need to remove the display panel or use the hair dryer. Follow these procedures to release the logic board:

- Remove the display panel, if not already removed.
- Remove all memory cards and leave the memory door off.
- Verify all screws have been removed.
- Verify all cables are disconnected and moved away from the procedure area shown below.
- Turn on a 1600 watt hair dryer and set it to high. Move the dryer back and forth continuously, left to right, about one second per cycle, over the area shown below, holding it about 20 mm (about 1-inch) above the board, for approximately one and a half minutes. (The temperature should reach approximately 75-80-degrees C (167-176-degrees F).)
- After at least 45-seconds, and while continuing to move the hair dryer as described above, insert a black stick just under the left edge of the logic board, where shown below, and apply slight upward pressure (do not pry). Continue the hair dryer procedure along with the slight upward pressure on the board until the thermal material releases and the board moves up easily.
- Once the thermal material has released, discontinue using the hair dryer.
- Continue to the next step before the thermal material cools.

**Warning: Do not use a heat gun, or damage can result.**

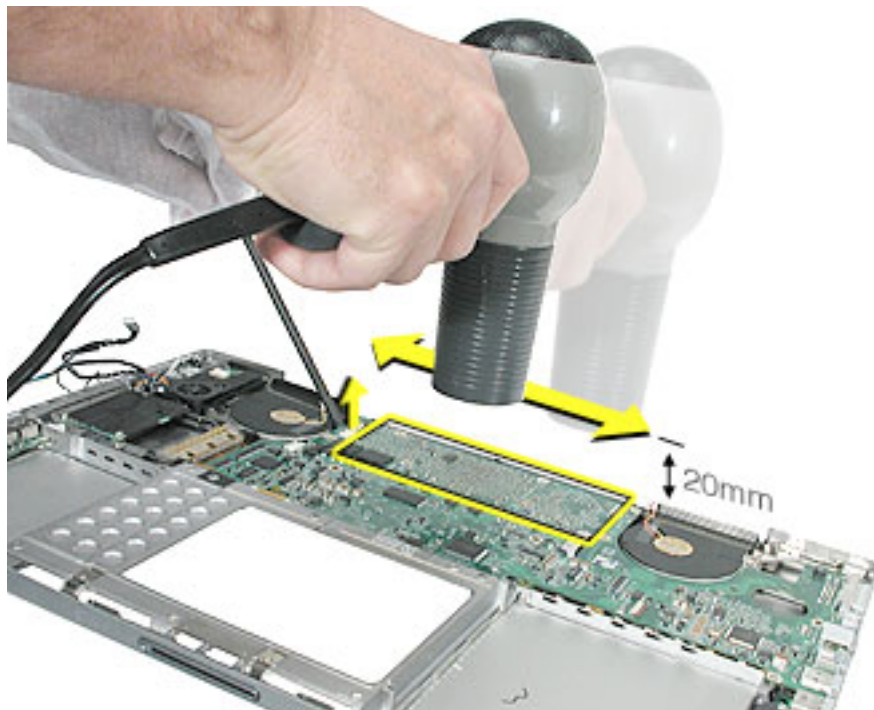

- Lift the left side slightly and remove the two connectors.

**Note:** The thermal material should easily release. If not, repeat the hair dryer procedure, above (verify that all the screws have been removed). Apply slow constant pressure until it releases, avoid over flexing.

**Warning:** Do NOT flex the board. Give special attention at the narrow neck of the blower cutout.

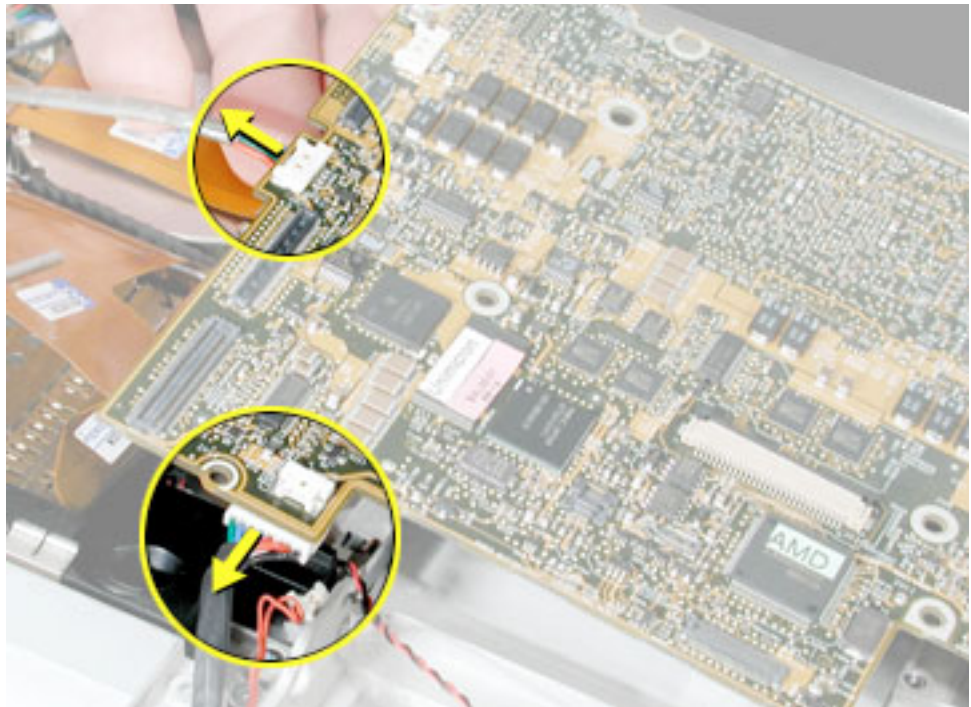



**Important:** When removing the logic board, verify that the thin aluminum washer, attached over the screw notch, shown below, has not fallen off into the computer. **Note:** There may be another similar washer attached to a standoff on the heatsink, just below the board at this location. This is ok.

**Replacement Note:** When handling the replacement logic board, verify that this washer is installed where shown below, and take care not to touch or bend it. If it is bent or out of place, reposition it before reassembling the computer. If it is missing, transfer it from the replaced board.

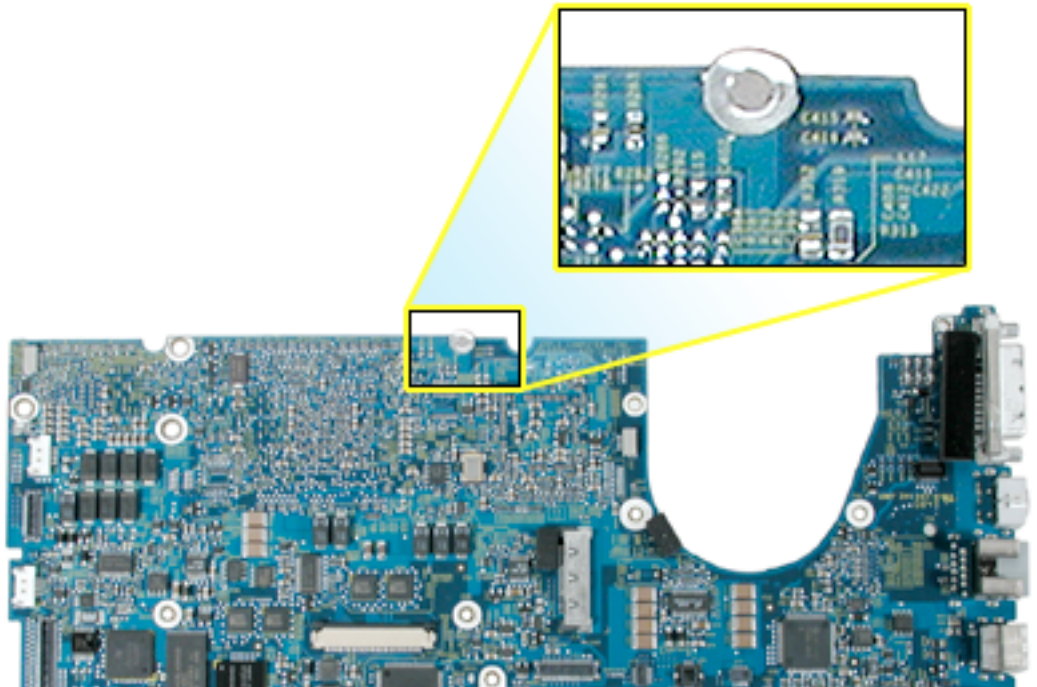

- Carefully lift the left side of the board and pivot along the ports side. Support the board along its sides as it lifts to avoid flexing.

**Warning: Do NOT flex the board. Give special attention at the narrow neck of the blower cutout.**

- Carefully pull the port end of the board out of the port openings.

**Note:** If the DVI port catches underneath, maneuver the board until it releases.

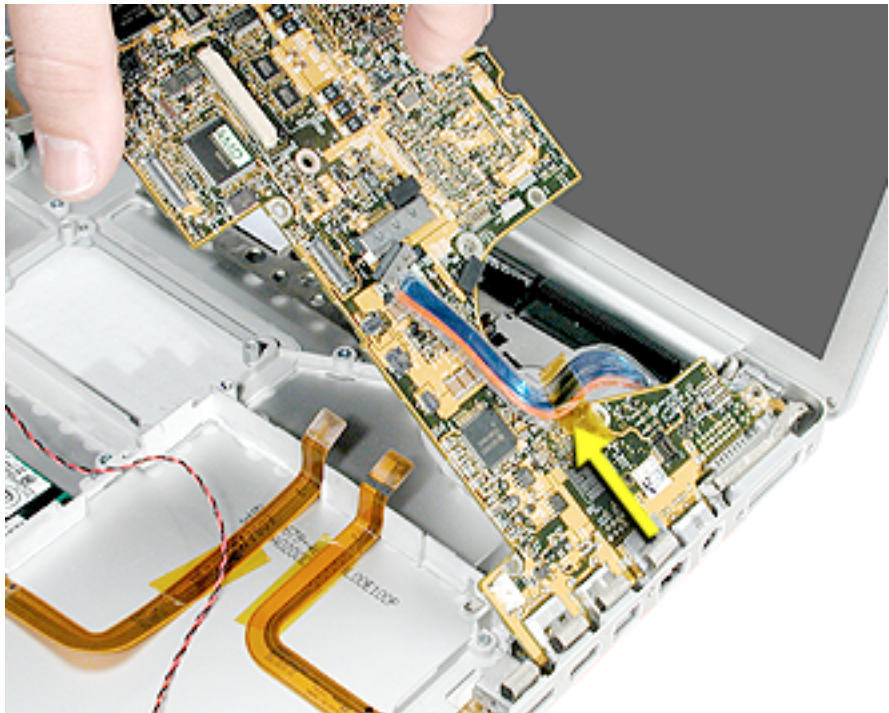

---

**Warning:** To avoid flexing the logic board, hold the board vertically along the wide sides. Do not hold the board by the ends or by the narrow neck at the blower cutout, or horizontally, as the board's weight can cause excessive flex.

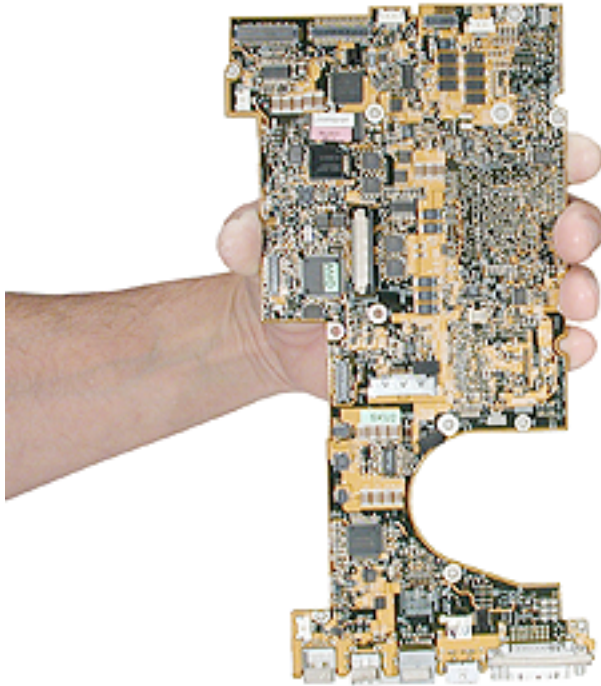

## Replacement Procedure

**Important:** Logic boards and heatsinks are matched sets. There are two configurations. Verify the configuration and replace like for like:

### 1.0 GHz & 1.25 GHz logic board and heatsink:

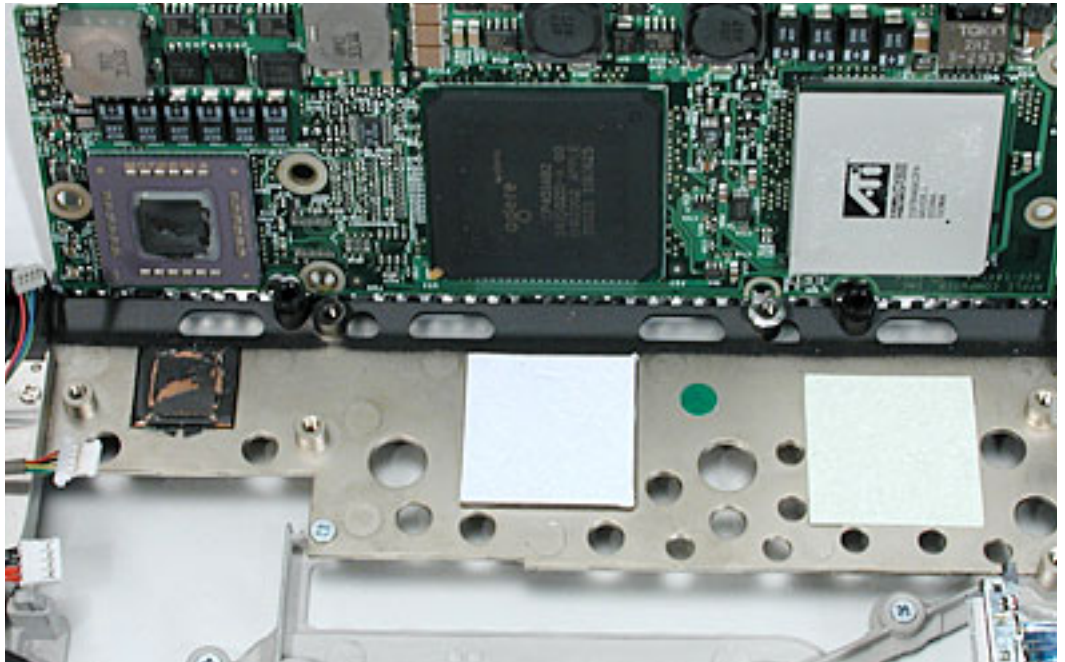

### 1.33 GHz & 1.5 GHz logic board and heatsink:

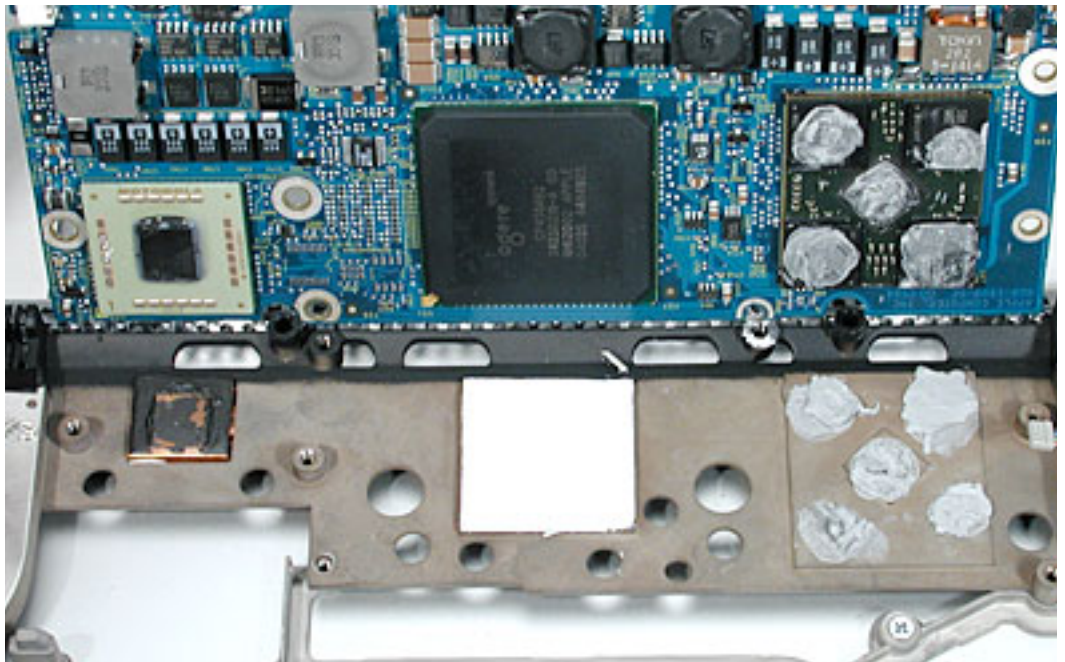

1. Verify that four rubber blocks are installed on the replacement logic board. If not, transfer them from the replaced board.

**Important:** Do not install the large block, shown at the top right, below, if an ambient light sensor will be installed at this location.

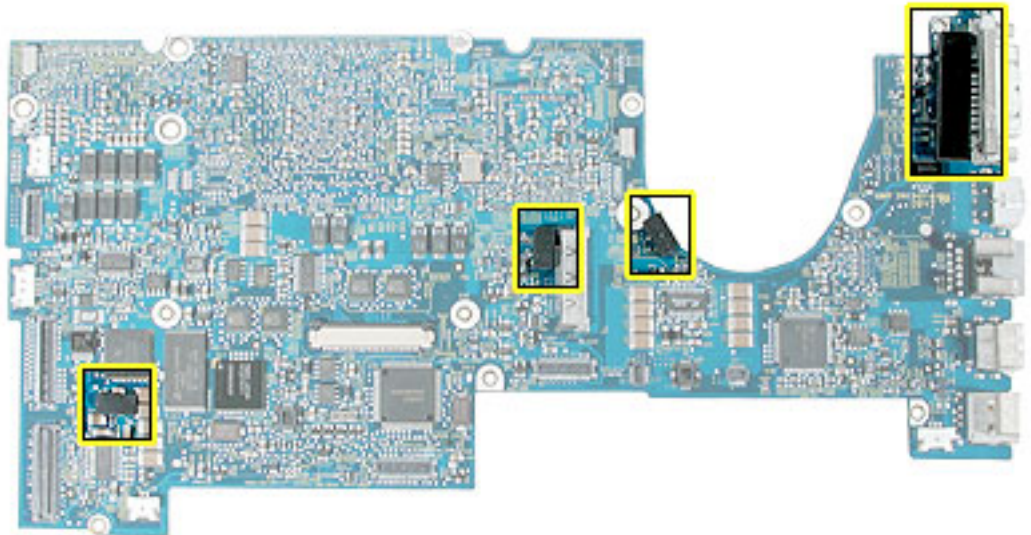

2. Install the EMI gaskets that came with the replacement logic board, where shown below. (If not included, order EMI gasket kit 076-1057.)



The following procedures show how to verify and replace the thermal materials:

**Warning: Whenever the logic board is separated from the heatsink, designated thermal material must be replaced. Failure to do so can cause the computer to overheat and be damaged.**

**Important:** When removing thermal material in the following procedures:

- Use a black stick to remove as much as possible
- Then use an alcohol pad to vigorously and completely remove any remaining material on the mating surface.

**Important:** To install new pads:

- Center each pad over the location that corresponds to the chip on the logic board and press into place, avoiding air pockets.
- Remove protective backing, if present.

**Important:** Avoid unnecessary contact with thermal pads as dirt and body oils reduce the pad's conductivity.

3. Only if damaged, replace the light colored thermal pad(s), shown below.

**For 1.0 GHz & 1.25 GHz logic board heatsinks:**

- Install the light blue pad (the thinner one) in the center, and the light green one on the right.

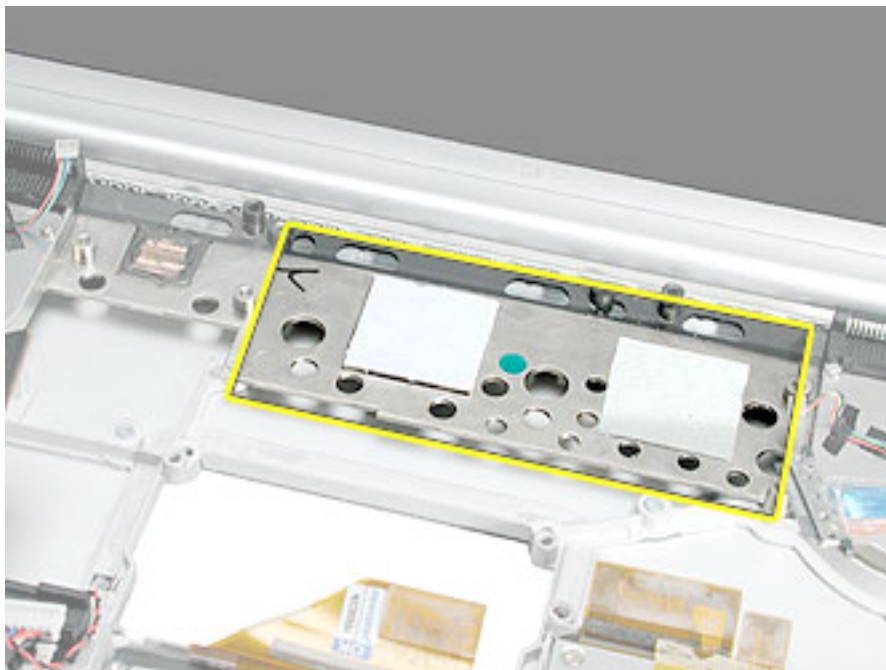

**For 1.33 GHz & 1.5 GHz logic board heatsinks:**

- Install only the light blue pad, in the center.

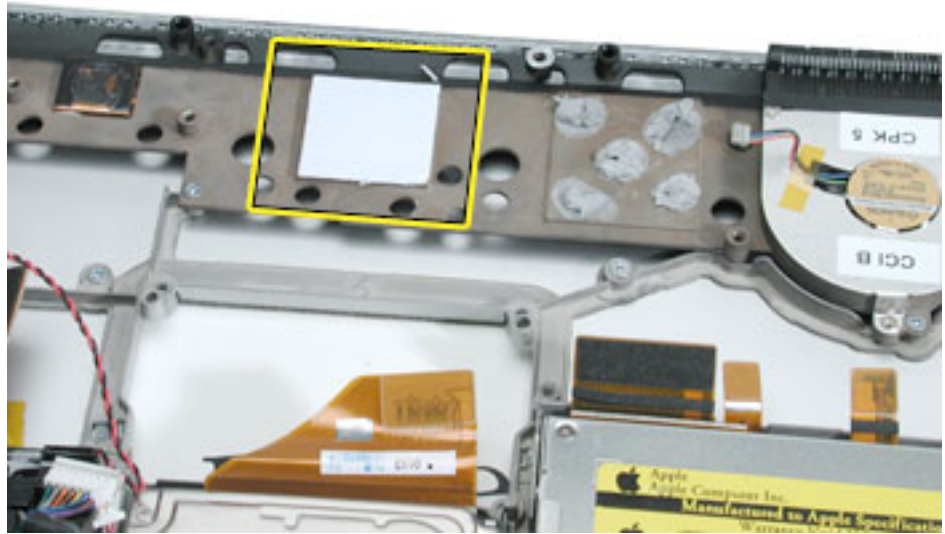

4. For 1.33 GHz & 1.5 GHz logic board heatsinks:

- Remove the thermal paste on the heatsink at the graphics chip location.

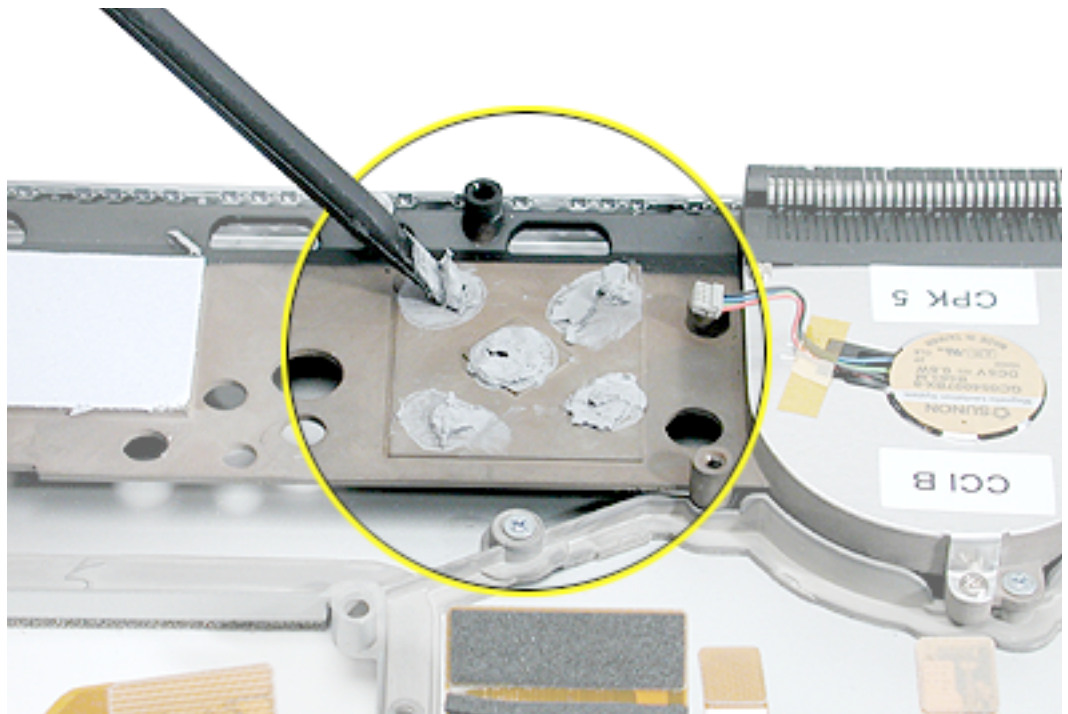

- Apply approximately 0.4 to 0.5 cc's of thermal paste (922-6495) in an "X" pattern over the raised mating surface pad on the heatsink, from corner to corner.

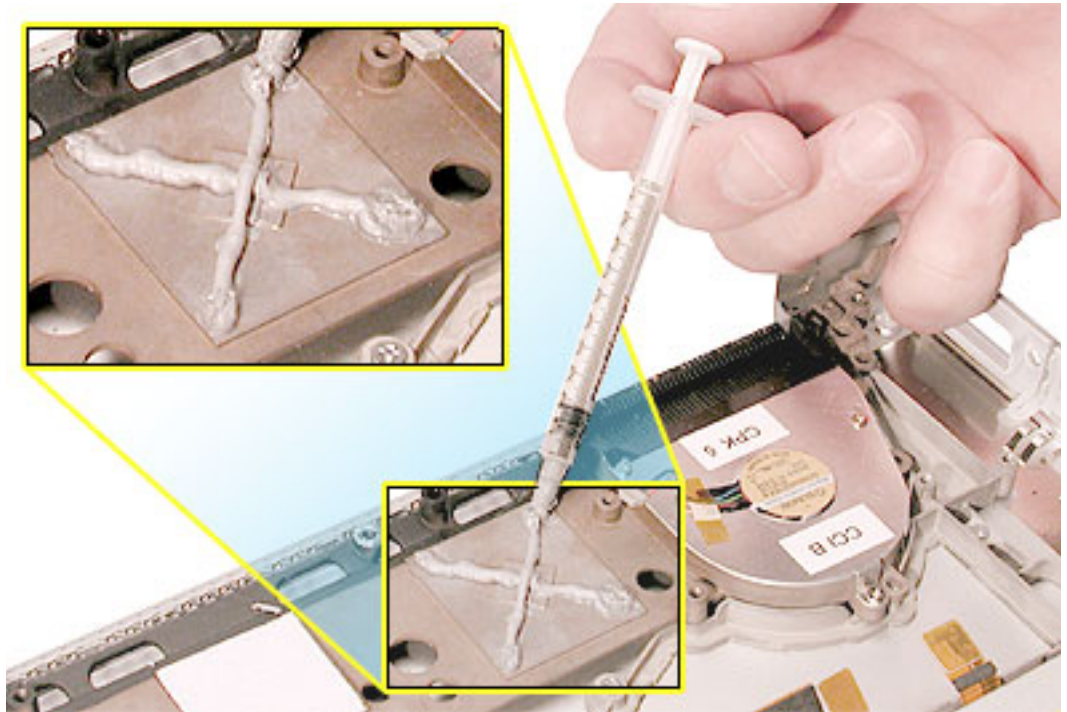

**For all logic board heatsinks:**

5. Remove all the original thermal material from the CPU mating surface, shown below. Install the new pad, avoiding air pockets.

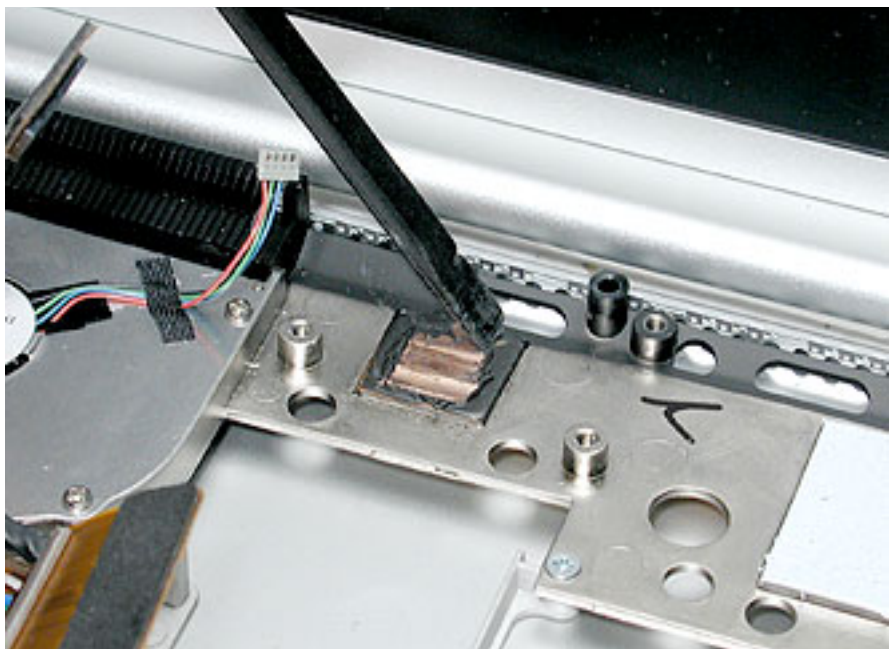



6. If the logic board was removed to facilitate another procedure and will be reinstalled, in the same manner as the heatsink, remove all thermal material from:
- The CPU chip on the bottom of the logic board
  - The graphics chip (if applicable)

**Important:** Use extreme care not to damage the chip or logic board components.

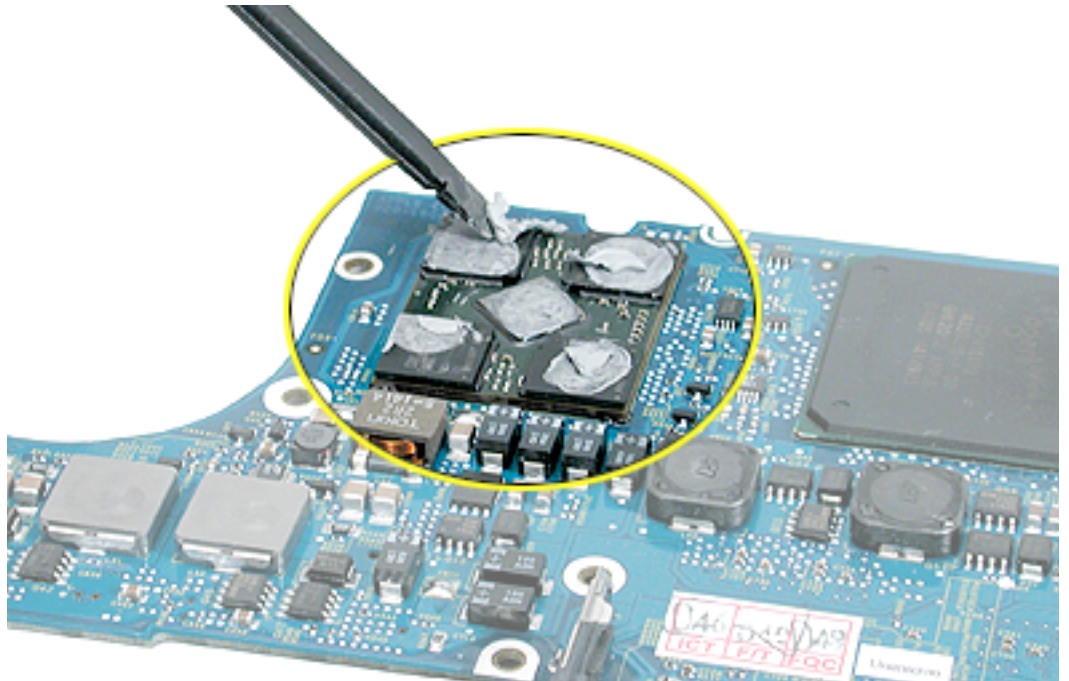
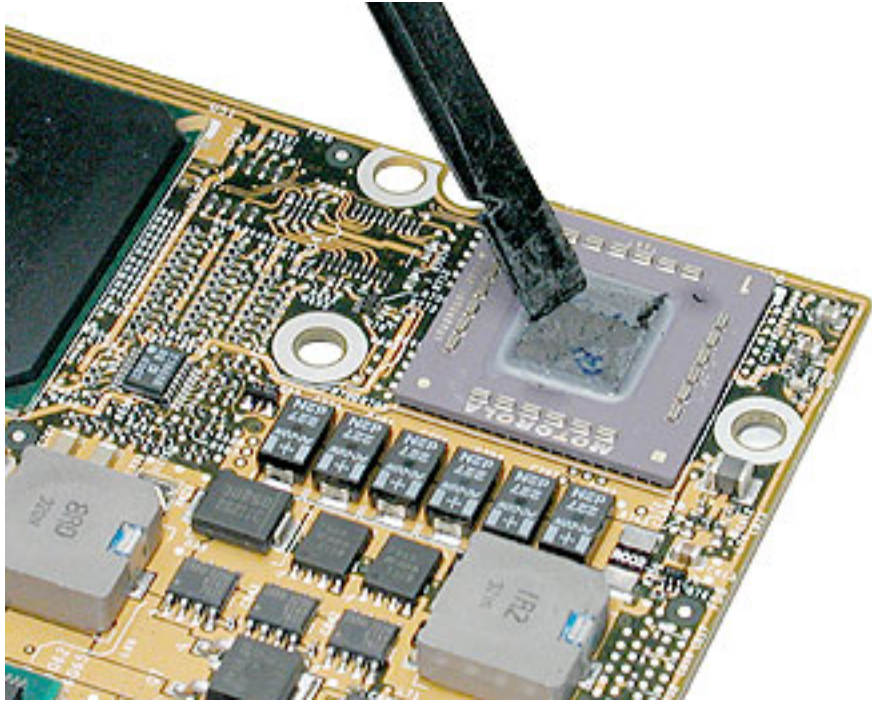

- When replacing the logic board, guide the port side into the port openings on the bottom case.

Connect the two connectors that go under the logic board on the left side of the board.

**Note:** Use care not to catch cables under the board as it is lowered into place.

- Attach the screws in the order shown.

**Note:** If a right ambient light sensor will be installed, install the upper right screw (9) during that procedure.

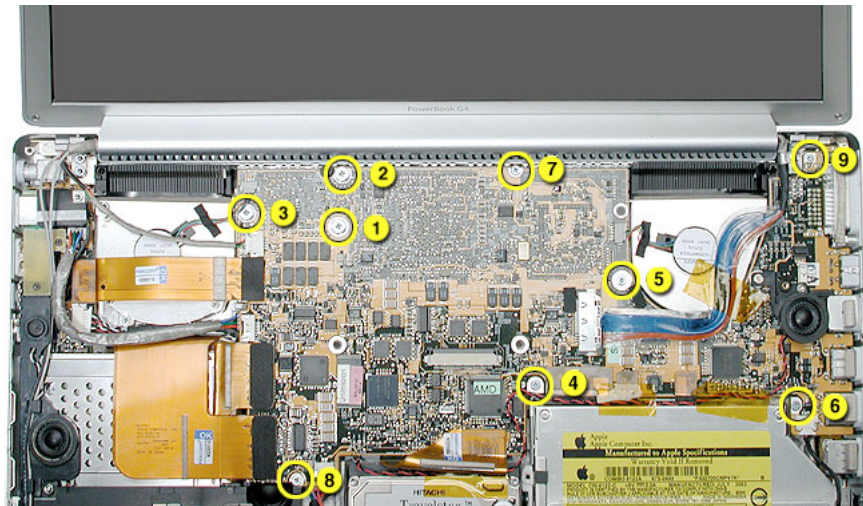

- Reassemble and test all ports, components and functions of the computer.

**Note:** After installing new thermal material, if you must briefly re-separate the logic board from the heatsink, it is OK to retain the same, new thermal material, as long as they are not handled excessively.



# Right Blower

## Tools

This procedure requires the following tools:

- #1 Phillips screwdriver (magnetized)
- Black stick (or other nonconductive nylon or plastic flat-blade tool)

## Part Location

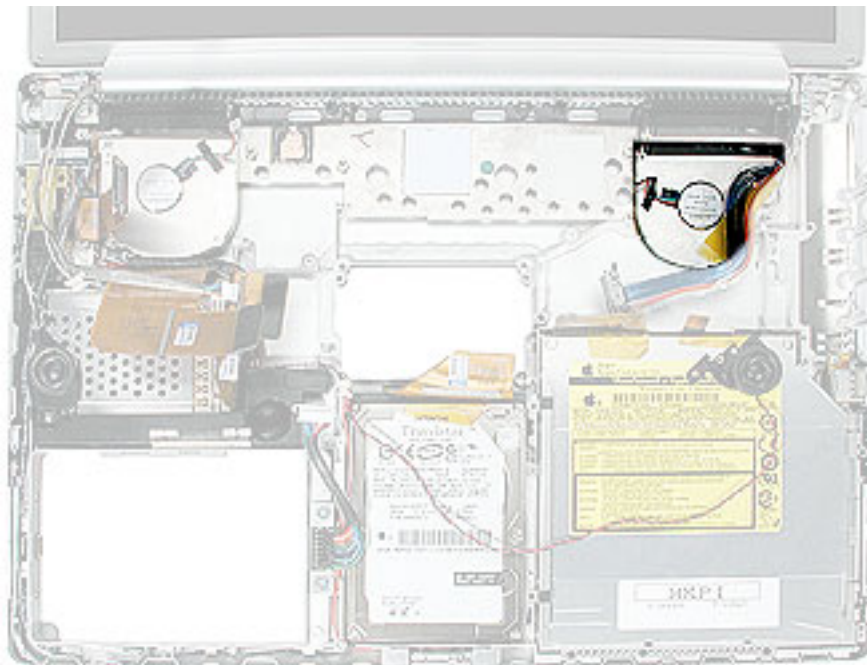

## Preliminary Steps

Before you begin, remove the following:

- Battery
- Top case
- Logic board

## Procedure

1. Remove the three screws, then lift off the blower.

922-6093



4.5 mm

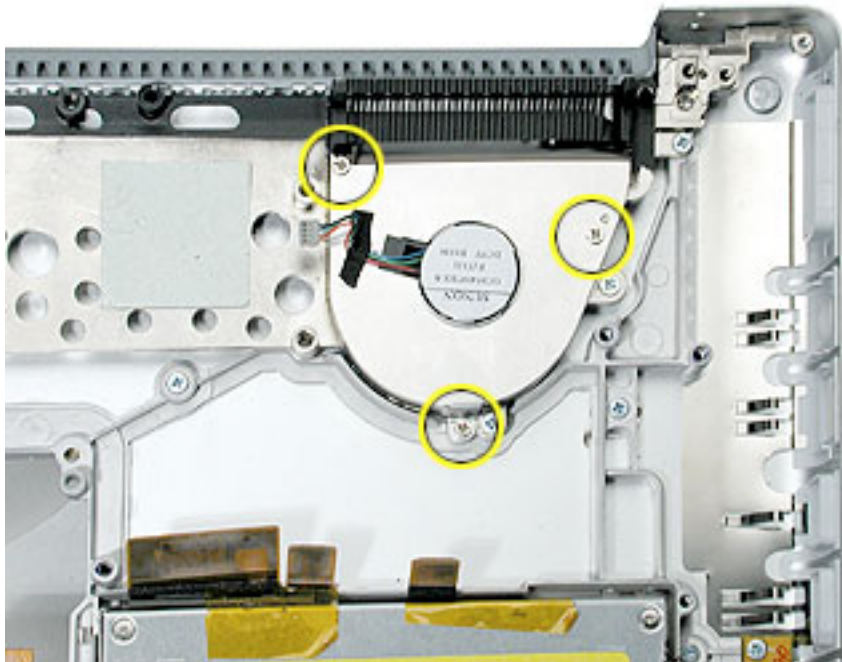

2. Install the replacement right blower and reseal tape strip (left blower shown).

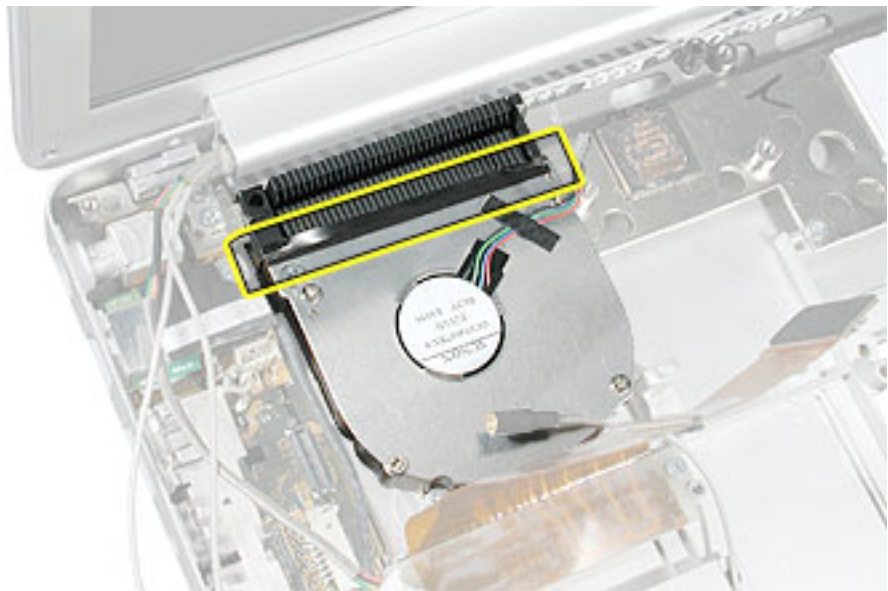

3. Reassemble the computer and test all ports, components and functions.



# Right USB Board

## Tools

This procedure requires the following tools:

- #1 Phillips screwdriver (magnetized)
- Black stick (or other nonconductive nylon or plastic flat-blade tool)

## Part Location

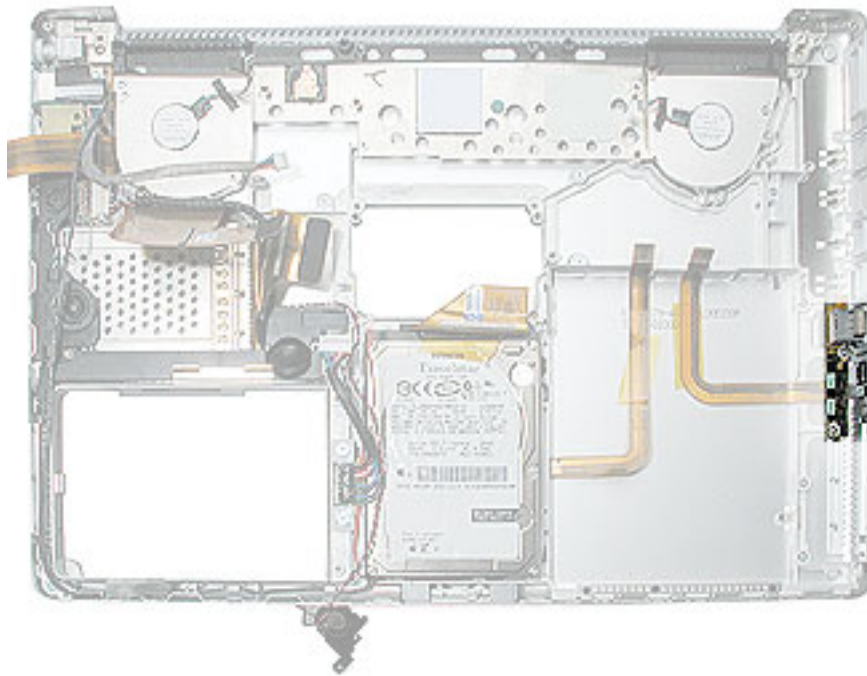

## Preliminary Steps

Before you begin, remove the following:

- Battery
- Top case
- Optical drive
- Logic board

## Procedure

1. Remove the two screws and guide the board out.

922-6472



4.5 mm

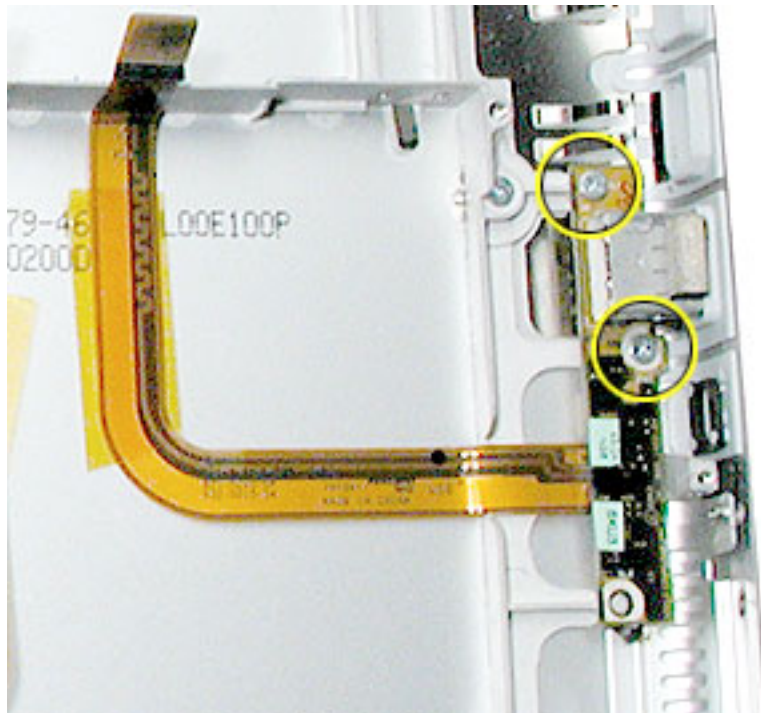

2. Disconnect the flex cable.



- 
3. If the EMI gasket is not installed on the replacement board, transfer the gasket from the old board, or install a new gasket, as shown.

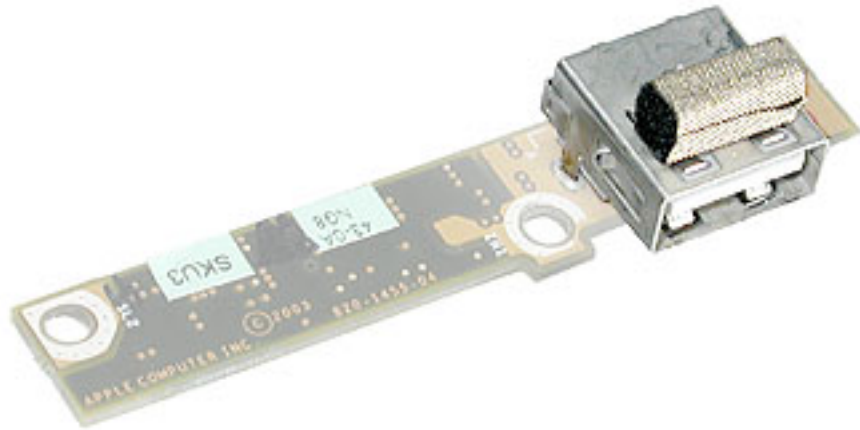

4. Install the replacement right USB board and reassemble the computer.
5. Test all ports, components and functions of the computer.



# Speakers

## Tools

This procedure requires the following tools:

- #0 Phillips screwdriver (magnetized)
- #1 Phillips screwdriver (magnetized)
- 4 mm socket wrench
- Black stick (or other nonconductive nylon or plastic flat-blade tool)

## Part Location

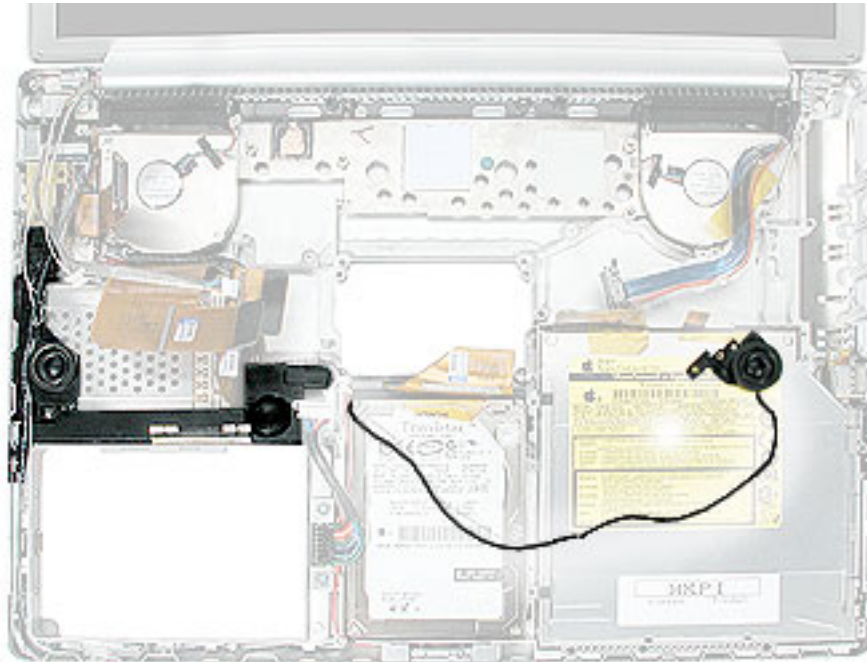

## Preliminary Steps

Before you begin, remove the following:

- Battery
- Logic board
- Left ambient light sensor board, if present



## Procedure

**Note:** Lift up any Kapton tape as necessary and reserve for replacement.

1. Remove the two screws and remove the small board (if a left ambient light sensor board was not removed in the preliminary steps).

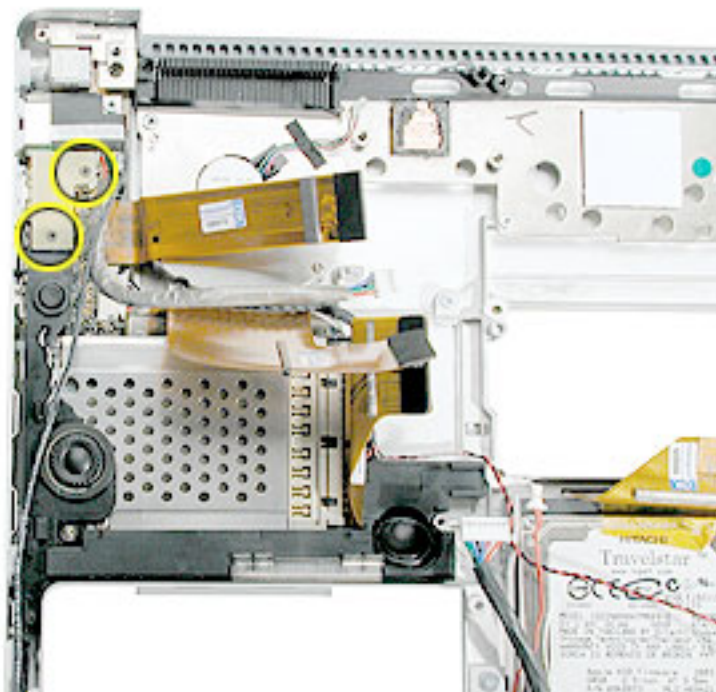

2. Carefully lift wires out of routing channels on the left speaker.

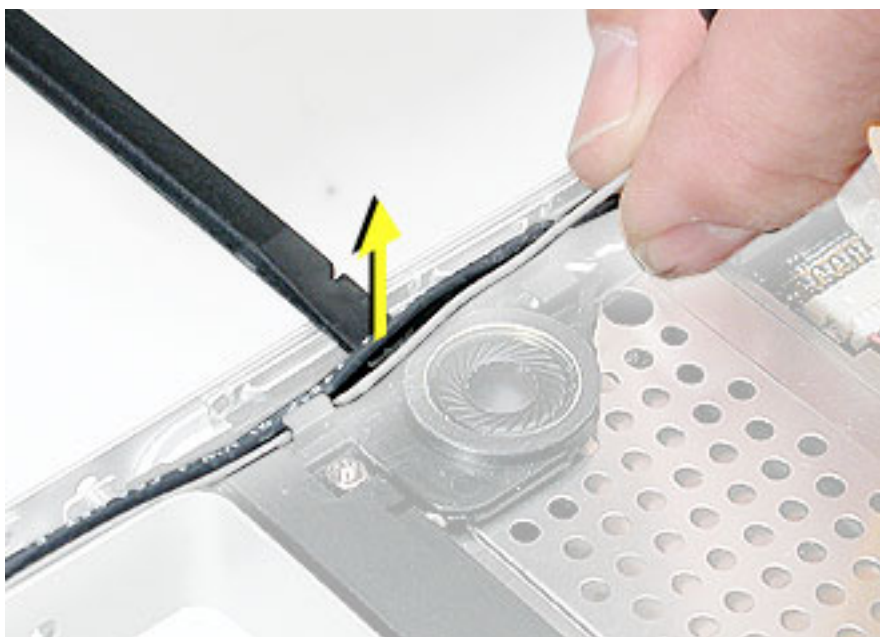

3. Remove the screw and nut, then carefully lift out the speaker assembly.
4. Disconnect the speaker cable from the Sound/DC-in board.

922-5840



4 mm

922-6090



3.2 mm

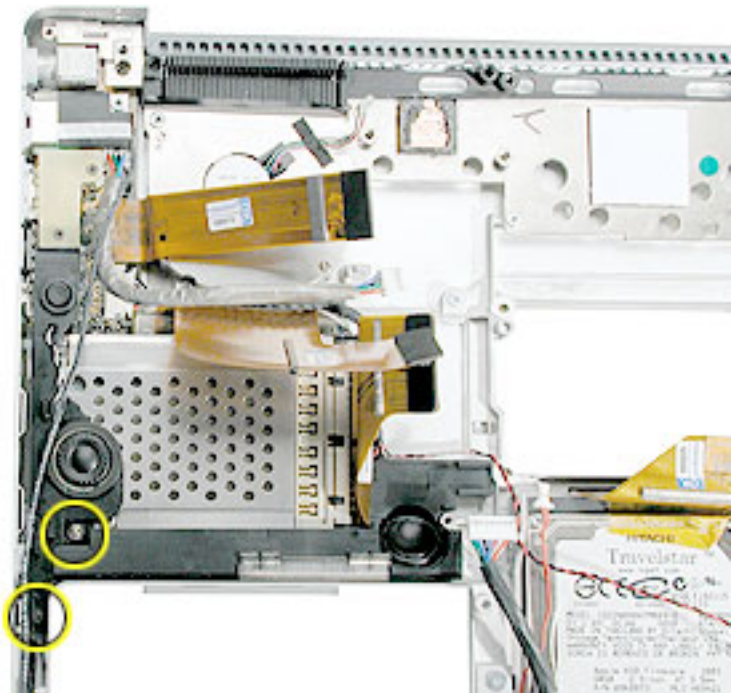

5. Install the replacement speakers, and reassemble the computer.

**Replacement Note:** Needlenose pliers may be helpful when reinstalling the nut.



6. Testing the computer should include using the Sound system-preference pane to test the left and right speakers.



# PC Card Cage

## Tools

This procedure requires the following tools:

- #0 Phillips screwdriver (magnetized)
- Black stick (or other nonconductive nylon or plastic flat-blade tool)

## Part Location

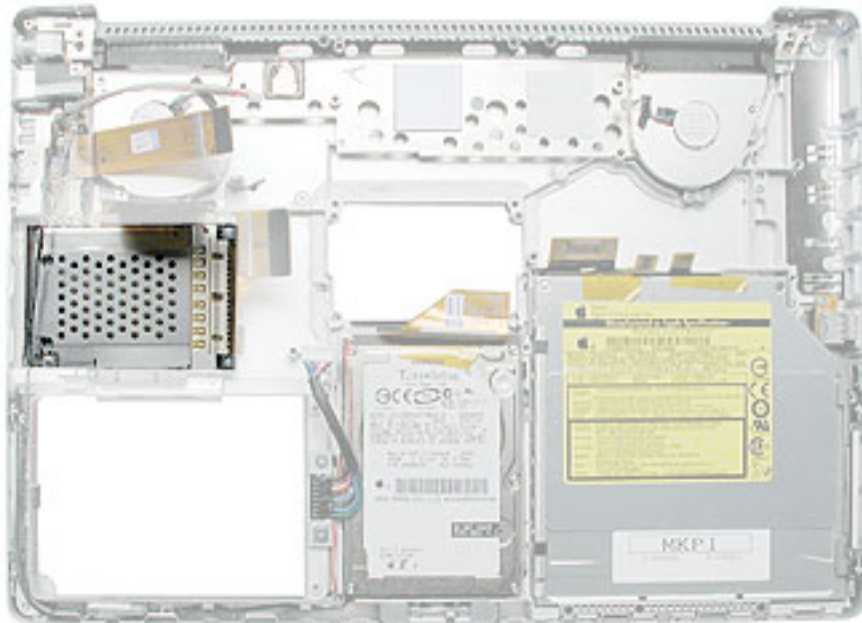

## Preliminary Steps

Before you begin, remove the following:

- Battery
- Speakers

## Procedure

1. Remove the four screws.
2. To remove the cage, lift it off of the eject button pin.
3. Remove the eject button for replacement.

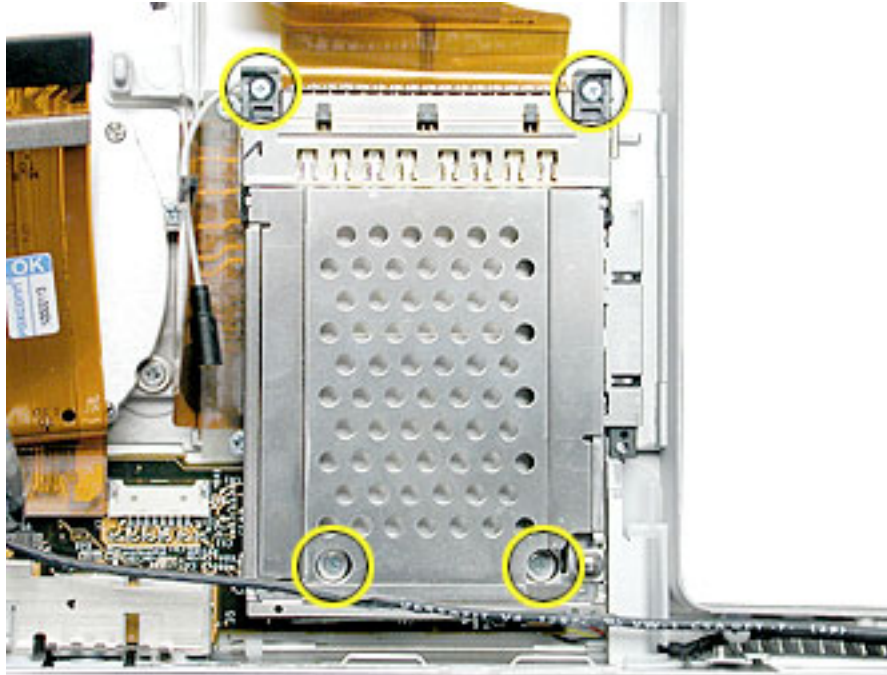

4. Verify the holes in the Sound/DC-in board, are aligned with the screw bosses under them on the bottom case so that the PC card cage screws will install.
5. Install the replacement PC card cage and eject button.

**Replacement Note:** Ensure that the pin on the PC card cage eject button is secured by the hole in the cage mechanism.

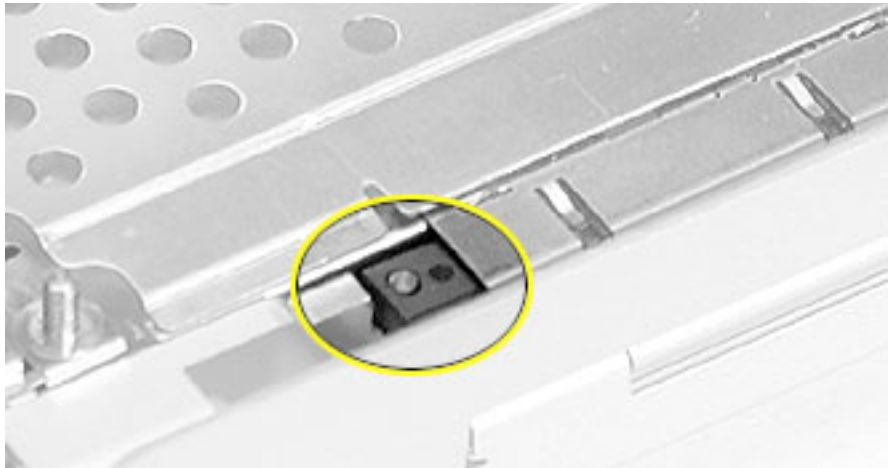

6. Lightly install all four screws before tightening (**note:** longer screws go in the back by the flex cable), then tighten in the following order.

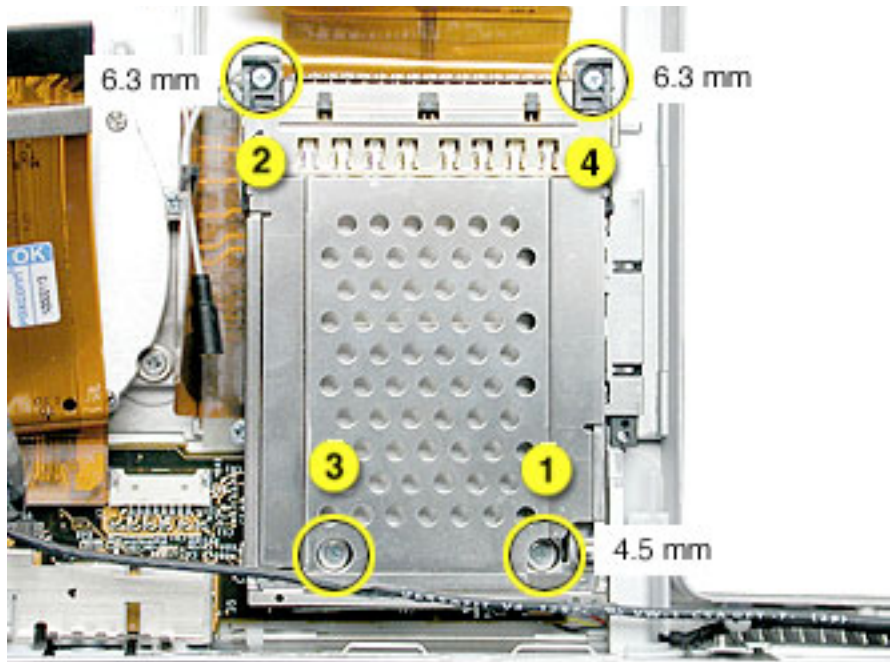

7. Reassemble the computer.
8. Testing the computer should include inserting a PC card to check that it can be locked in and that the eject button works smoothly.



# AirPort Extreme Slot & Flex Cable

## Tools

This procedure requires the following tools:

- #0 Phillips screwdriver (magnetized)
- #1 Phillips screwdriver (magnetized)
- Black stick (or other nonconductive nylon or plastic flat-blade tool)

## Part Location

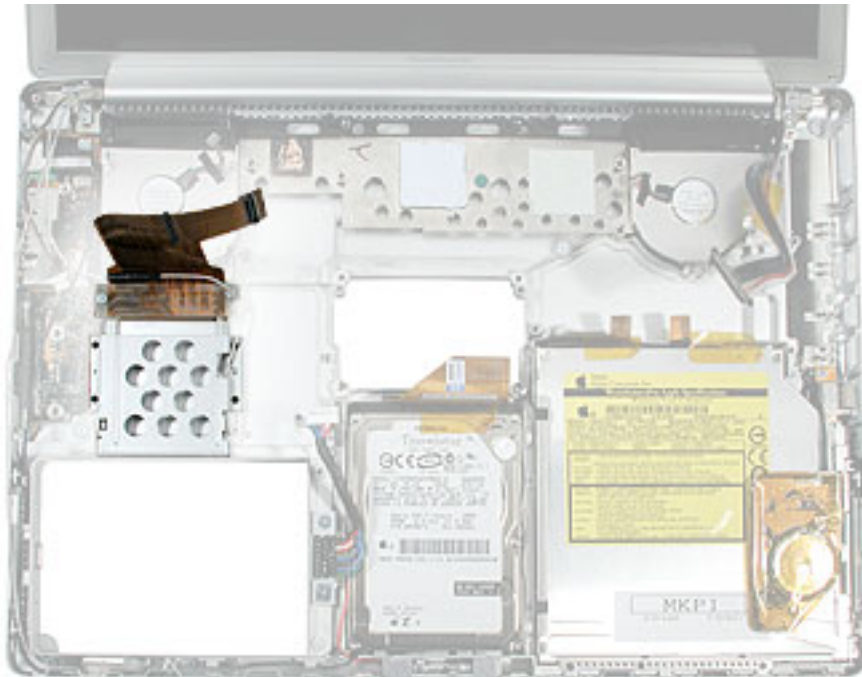

## Preliminary Steps

Before you begin, remove the following:

- Battery
- AirPort Extreme card
- PC card cage

## Procedure

1. Disconnect the AirPort Extreme antenna coupling. Grasp the coupling (not the wires) at both ends and pull to separate at the middle.

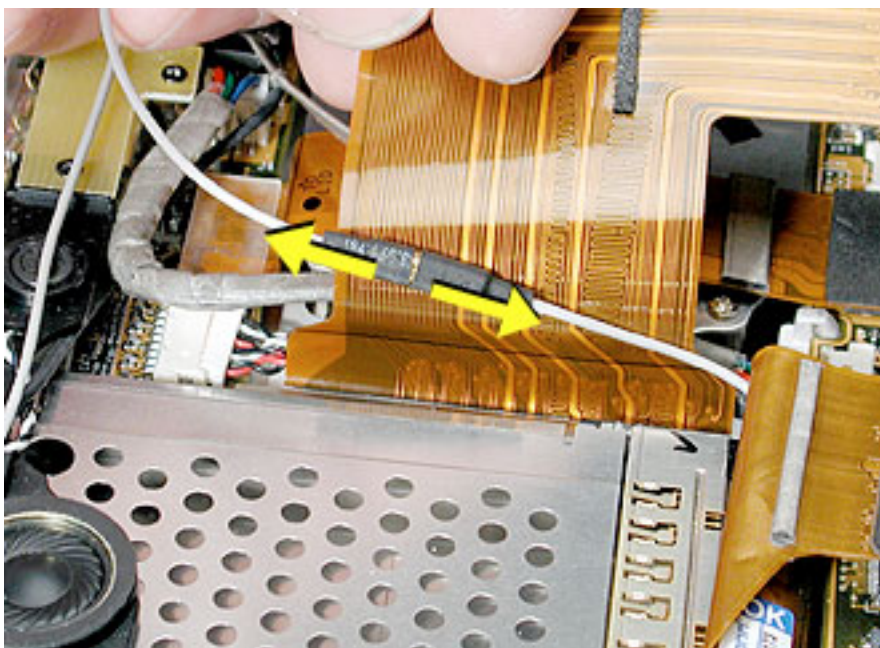

2. If replacing the AirPort Extreme flex cable, remove the two screws.

922-6472



4.5 mm

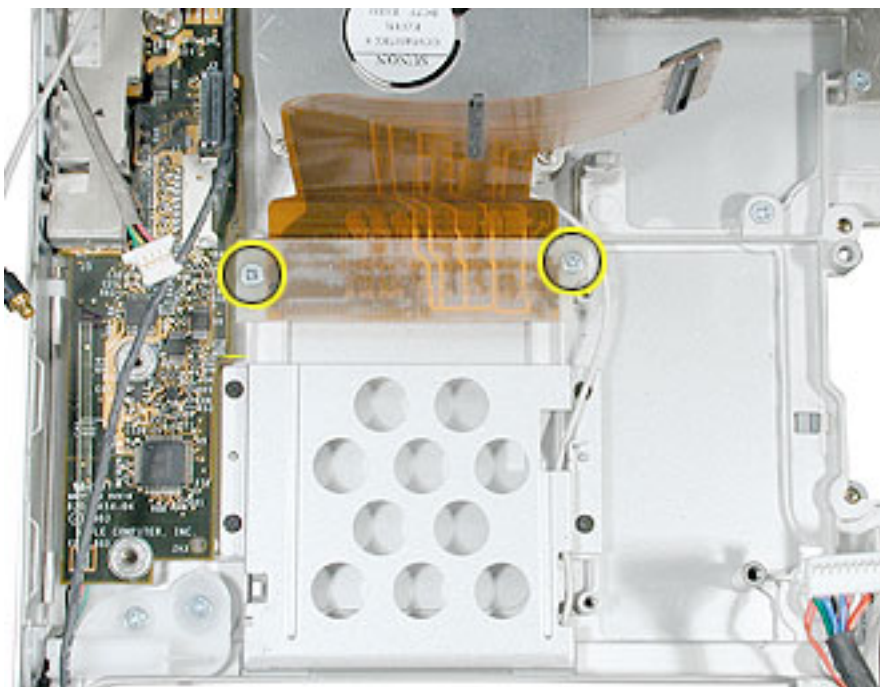

3. Remove four screws and lift out the AirPort Extreme card cage.

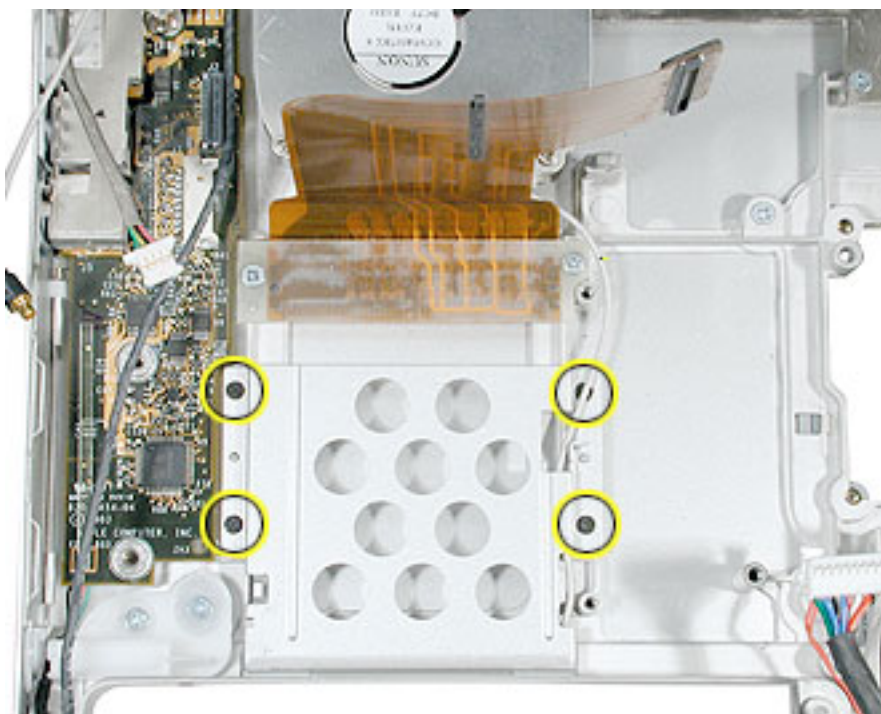

4. Notice the routing of the antenna cable jumper and remove. If not replacing, transfer to the replacement cage.

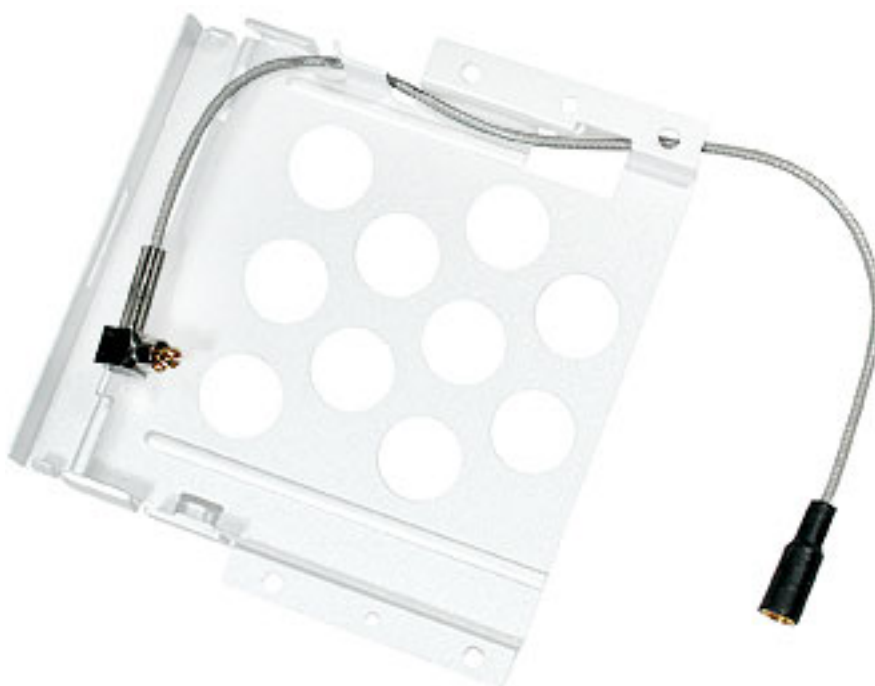



- 
5. Install the replacement AirPort Extreme card cage.

**Replacement Note:** Make sure the AirPort Extreme card cage door is closed before installing.

6. Reassemble the computer.
7. Testing the computer should include inserting an AirPort Extreme card to check that it can be fully inserted and the door closed. Use Apple System Profiler to check that the AirPort Extreme card is recognized. Test that the AirPort Extreme card is working.



# Heatsink and Blowers Assembly

## Tools

This procedure requires the following tools:

- Torx T8 screwdriver (magnetized)
- #1 Phillips screwdriver (magnetized)
- Thermal pad kit (076-1055), if not replacing the heatsink
- Alcohol pads

## Part Location

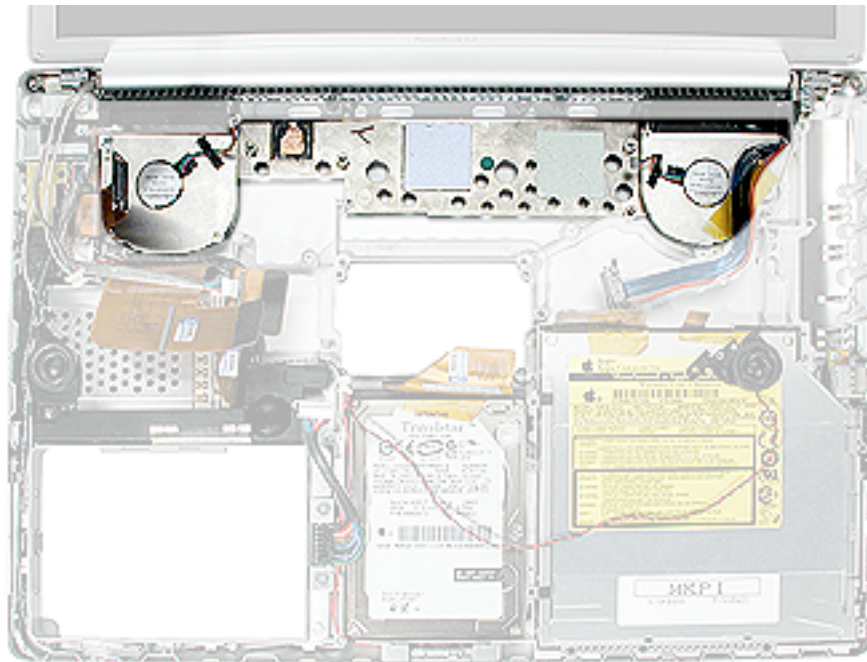

## Preliminary Steps

Before you begin, remove the following:

- Battery
- Display panel assembly
- Logic board

---

## Procedure

**Note:** The heatsink and blowers are one assembly part.

1. Remove the screws and lift out the heatsink and blower assembly.

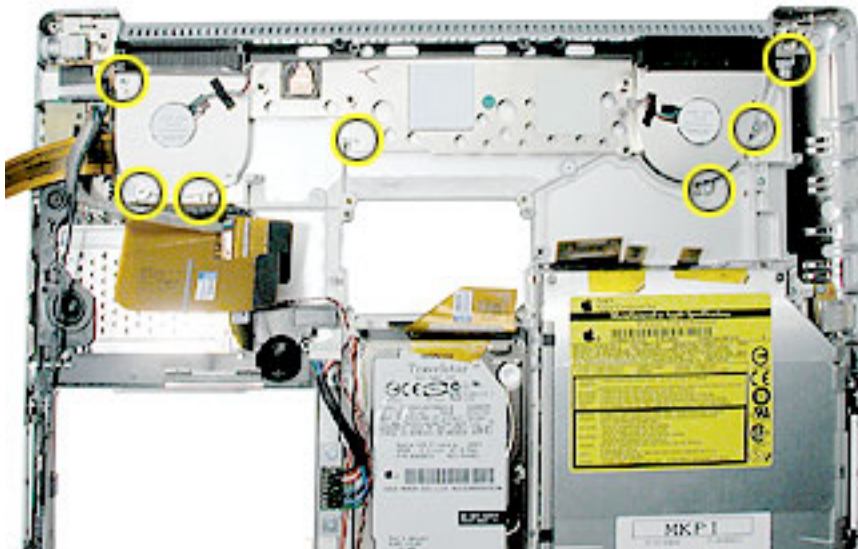

**Important:** Do not attempt to transfer blowers from one heatsink to another. This can create acoustic issues.

2. If the heatsink was removed to facilitate another procedure and will be reinstalled, follow the procedures in the Logic Board chapter about replacement of thermal pads.
3. If installing a replacement heatsink, and the thermal pads are not pre-installed, follow the procedures in the Logic Board chapter to install the thermal pads.

**Important:** Do not install a heatsink with damaged or missing thermal pads.

4. To install the replacement heatsink, install the screws in the order shown.

**922-6475**

#7



9.5 mm

**922-6474**

#6



5.5 mm

**922-6472**

#4



4.5 mm

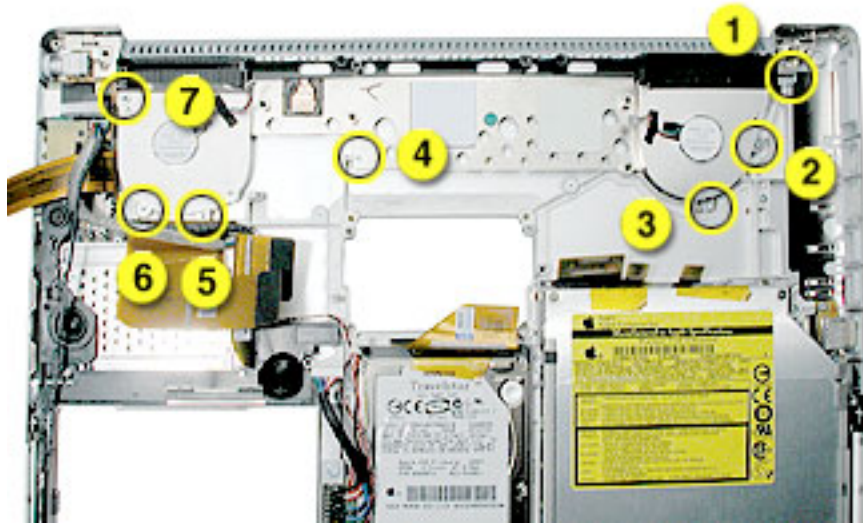

5. Reassemble and test all ports, components and functions of the computer.



## Sound/DC-In Board

### Tools

This procedure requires the following tools:

- Torx T8 screwdriver (magnetized)
- 5 mm socket wrench
- Black stick (or other nonconductive nylon or plastic flat-blade tool)

### Part Location



### Preliminary Steps

Before you begin, remove the following:

- Battery
- PC card cage
- Heatsink

**Note:** Replacing the RJ-11 port and wire requires removing the hard drive.

## Procedure

1. Remove the screws.

922-6098



13 mm



14.2 mm

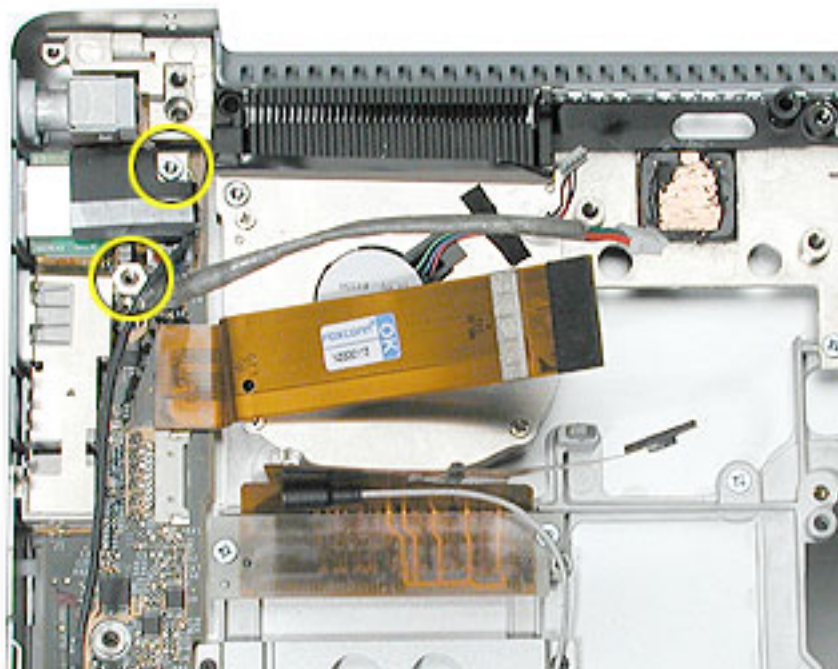

2. Disconnect the power and flex cables.

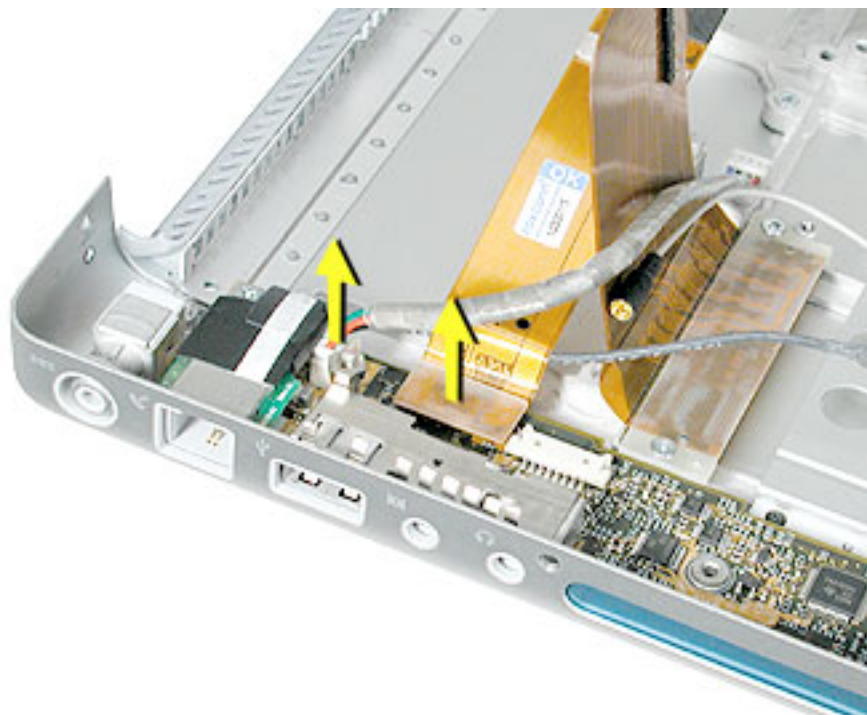

3. Guide out the sound/DC-in board.

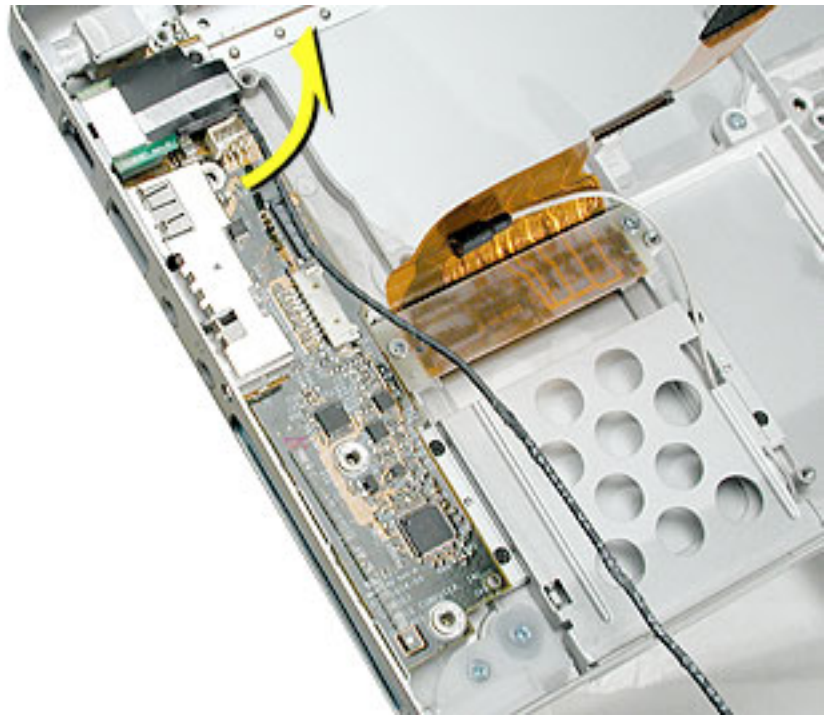

**Replacement Note:** Install the “TO MLB” side of the flex cable to the logic board.

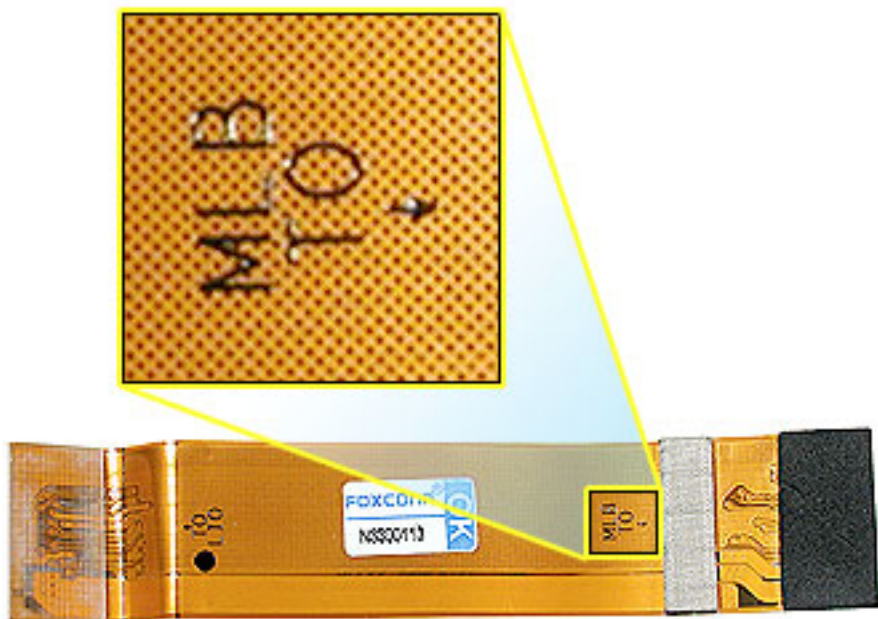

4. Turn the board over and disconnect the Bluetooth cable.



5. Remove the RJ-11 port, with attached cable, to transfer to the replacement board.  
The RJ-11 port slides off the sound/DC-in board but may be very tight. It may be helpful to pull on the port, or push it with the flat blade of a black stick, until it begins to move, then use a black stick to create leverage behind the port.

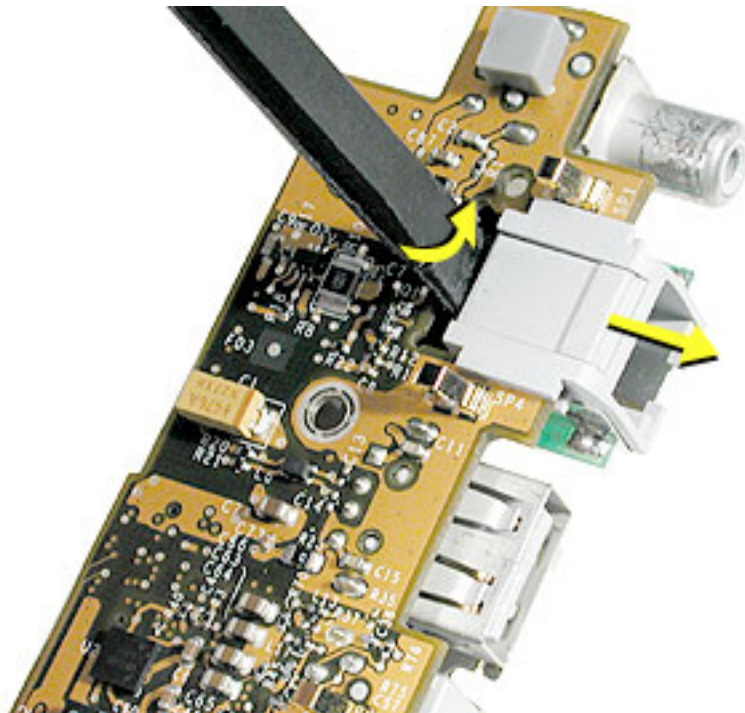



**Replacement Note:** If the replacement sound/DC-in board has an RJ-11 port installed, remove it and install the existing RJ-11 port.

The RJ-11 board must go above the standoff.

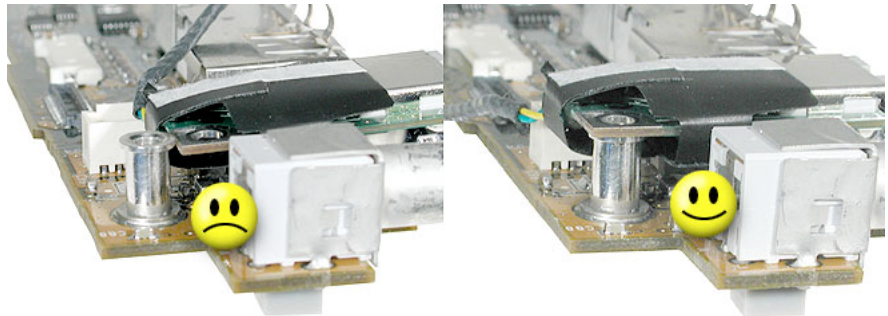

6. **Important:** Connect the Bluetooth connector to the replacement sound/DC-in board.
7. Install the replacement sound/DC-in board.

**Replacement Note:** Verify that the port EMI metal rests above the port plastic.

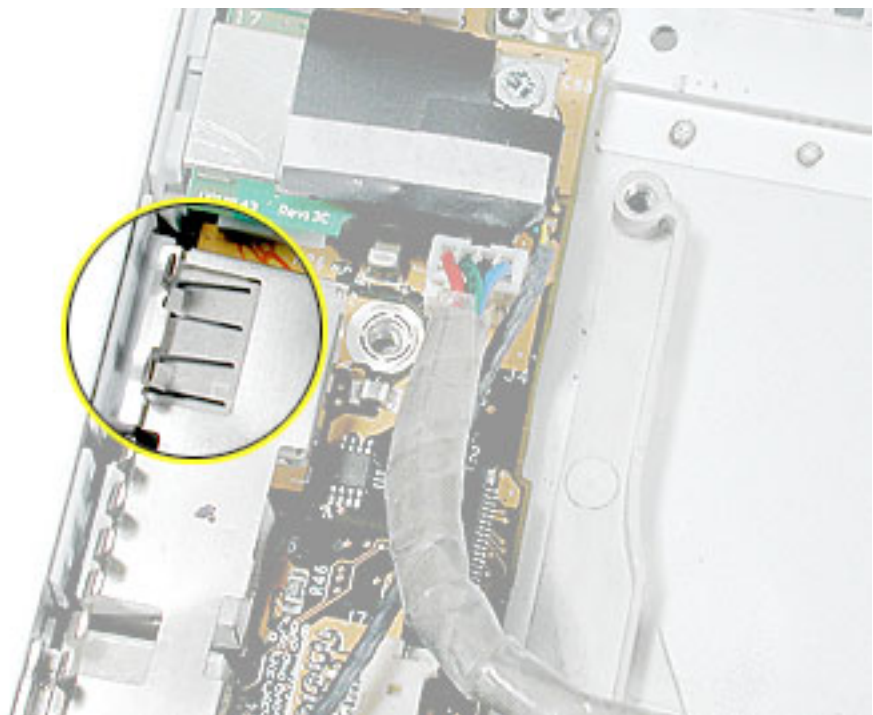

**Replacement Note:** Verify that the screw pass-through holes, at the Bluetooth connector end of the board, line up with the screw bosses below them so that the PC card cage screws can install properly.

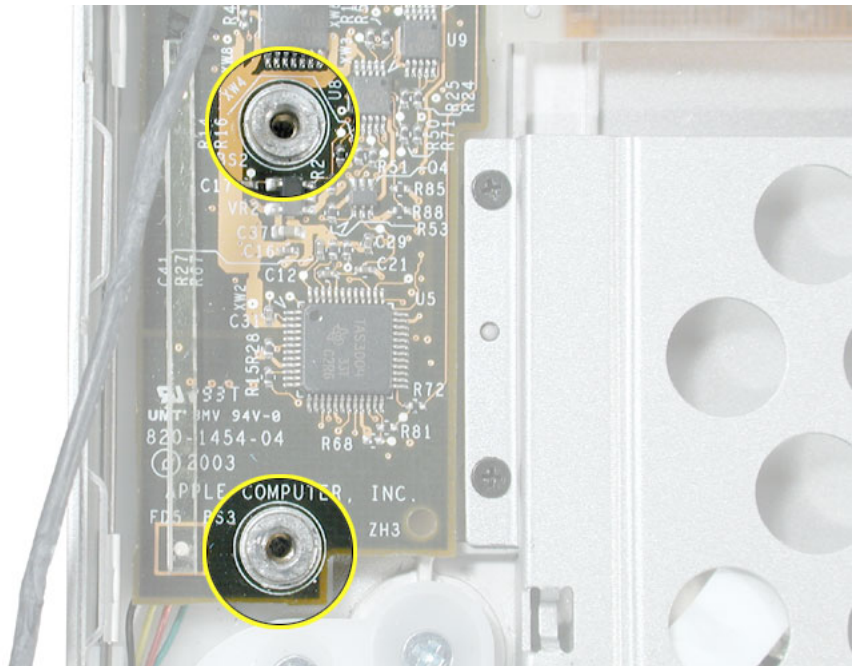

8. Connect the speaker, power, and flex cables.
9. Reassemble and test the computer.
10. Testing should include using Bluetooth to connect to another computer. Check the function of the modem port, DC-in port and the left USB port.



# Bottom Case Assembly

## Part Location

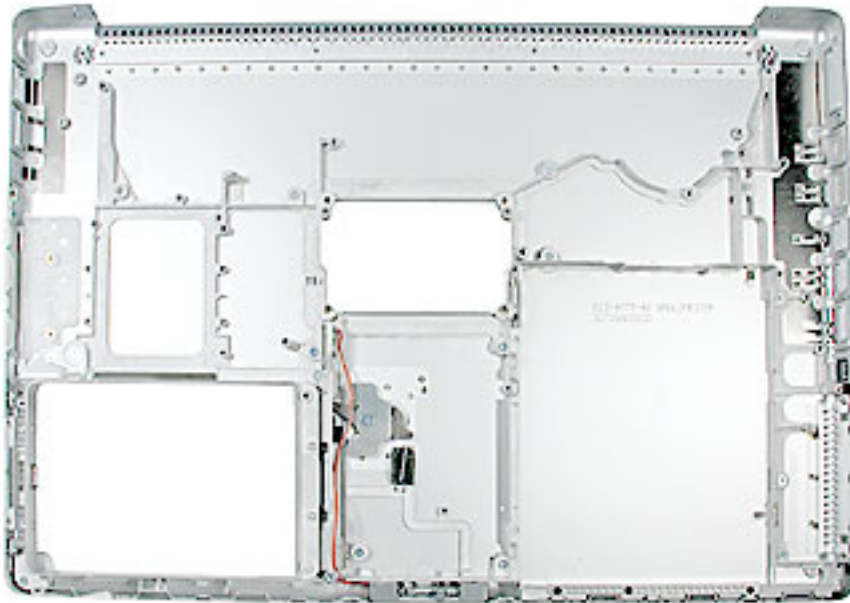

## Preliminary Steps

Before you begin, remove the following:

- Battery
- Optical drive
- Modem
- AirPort Extreme card cage and flex cable
- DC-in board
- Bluetooth board

## Procedure

1. Verify that the following items are on the replacement bottom case:
  - EMI shields
  - Display latch assembly
  - Battery latch assembly
  - Sleep LED and wire connector assembly

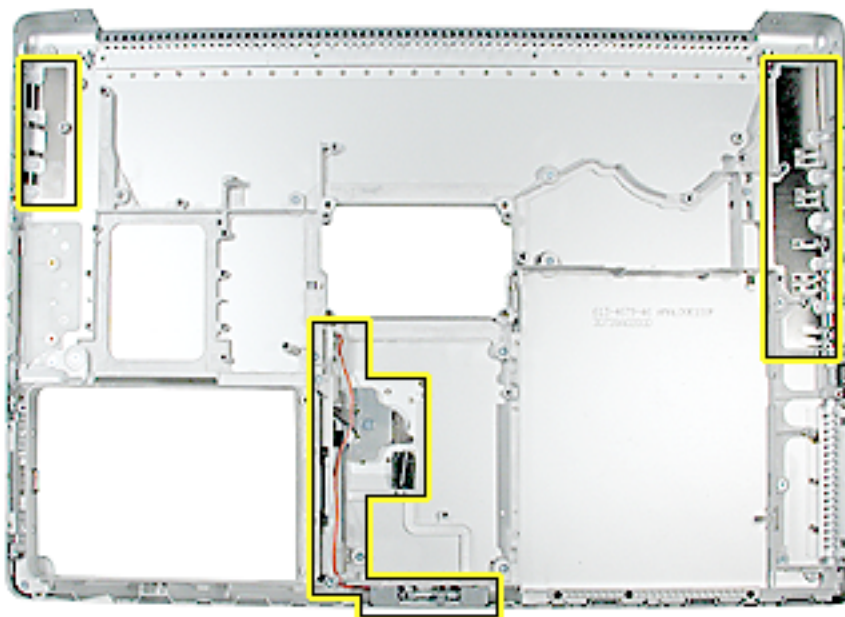

2. Remove the battery connector and cable from the removed bottom case; transfer to the replacement bottom case.

922-6092



3.5 mm

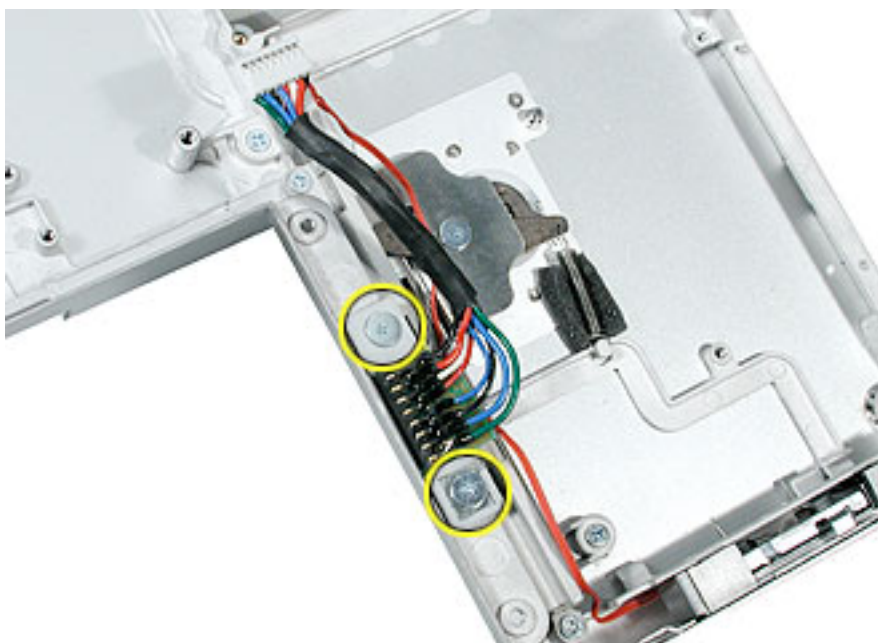

3. Remove two screws and remove the hard drive holder; transfer to the replacement bottom case.

922-6472



4.5 mm

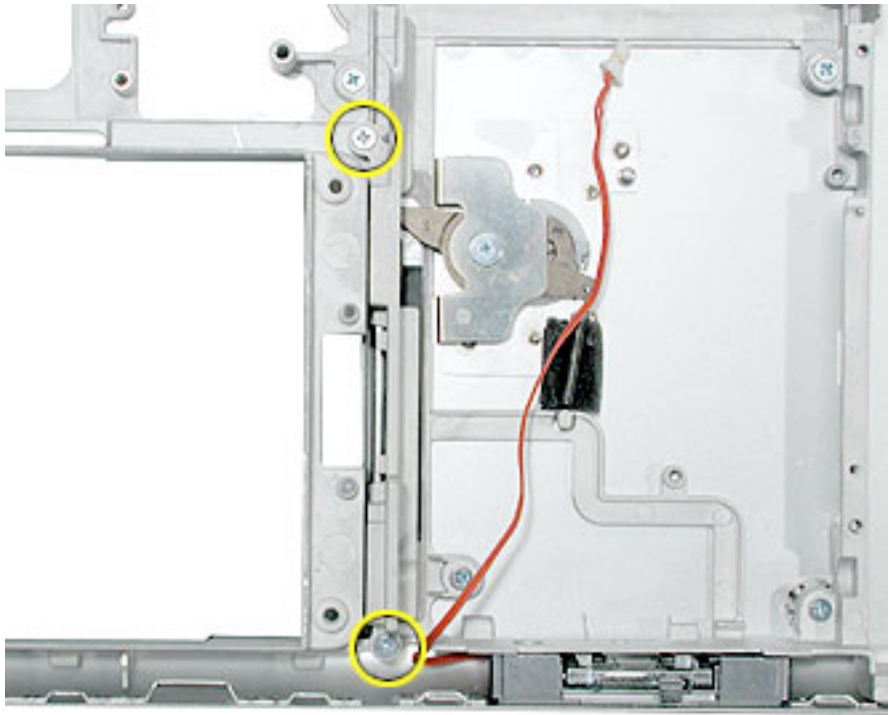

4. Reassemble and test all ports, components and functions of the computer, including battery operation.



# Display Rear Housing

## Tools

This procedure requires the following tools:

- Torx T6 screwdriver (magnetized)
- Black stick (or other nonconductive nylon or plastic flat-blade tool)
- Something to rest the housing against while disconnecting the antenna cables
- Soft cloth to protect the display face

## Part Location



## Preliminary Steps

Before you begin, remove the following:

- Battery
- Top case
- Display panel assembly

## Procedure

1. Remove the two screws at the bottom corners of the display bezel.

922-6487



6.1 mm



2. Holding the display assembly up on one side, carefully push with your thumbs on the edge bead to disengage the rear housing from three tabs on the side of the bezel.

**Note:** The rear housing does not need to completely disengage from the bezel at this point.

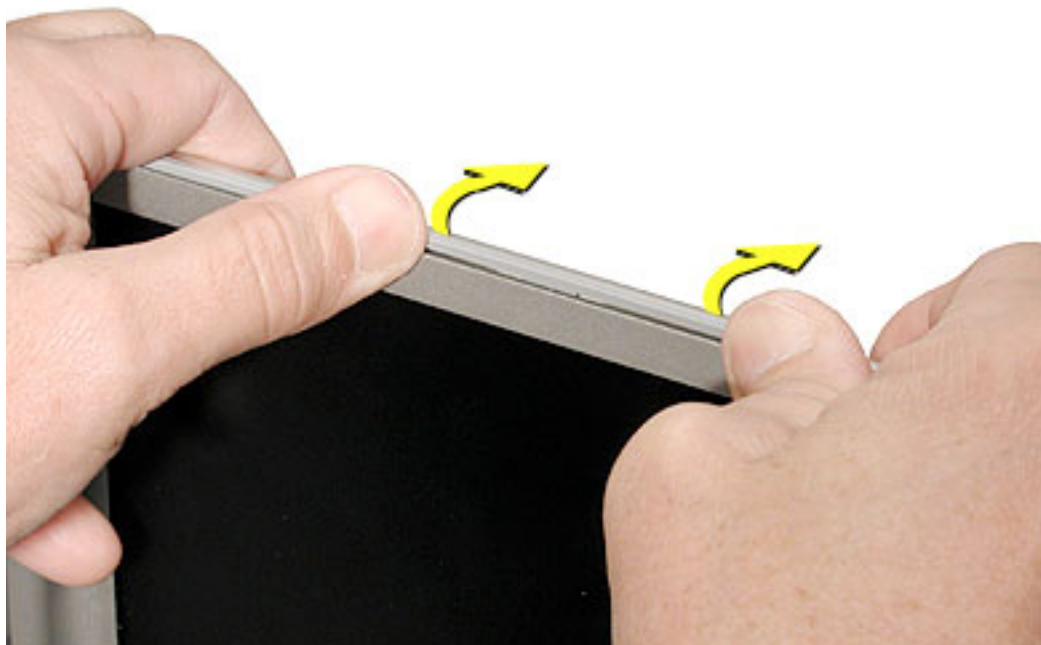

---

A black stick may also be helpful to disengage the housing from the tabs.

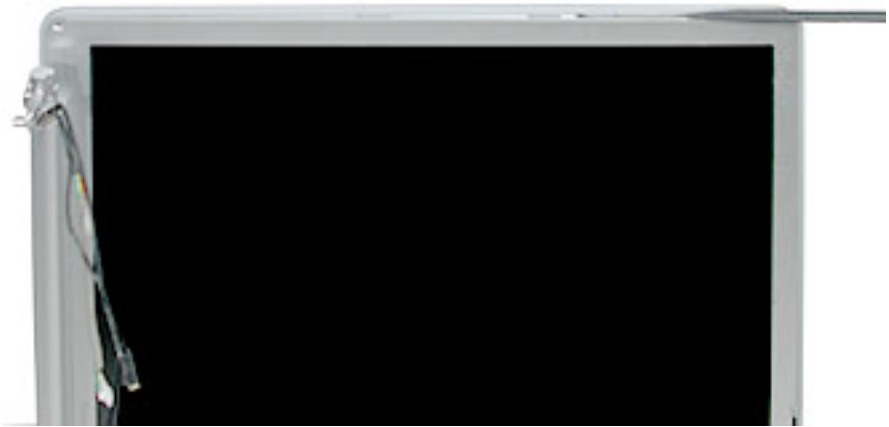

3. Repeat step 2 on the other side of the display.
4. Use a black stick to carefully work around the bottom corners (clutch side).

**Note:** The grey trim bead is part of the rear housing. Make sure to work the black stick on the correct side of the bead.

5. With the housing loosened on both sides, slide a black stick between the seam of the clutch cover and the rear housing. Twist the black stick as you go to increase separation.

**Important:** The grey trim bead that is part of the rear housing continues as an insert along the bottom, where it secures clips under the clutch cover. The material is fragile, so do not use too much force with the black stick. Also, be careful that it does not separate from the rear housing.





6. To help disengage the clips under the clutch cover, you may need to push down with your thumb over the clip location on the clutch cover, while slightly pulling the rear housing to disengage.



7. When the rear housing is loosened on the sides and bottom, run the black stick along the gap at each corner to slightly separate the rear housing from the display assembly.

**Warning:** The rear housing is connected to the display assembly with two antenna cables. Do not remove the rear housing until these cables have been disconnected, in the procedure below.



8. Place the display with rear housing face down on a soft clean cloth.
9. Tilt up the rear housing and rest it against something to access the cables opposite the LVDS connector. Be careful not to strain the cables.

**Warning: Handle the display by the edges only. Avoid pressure on the back of the display (the white area of the LCD panel).**



10. Note that the two antenna cables route along the side of the rear housing and are connected to the diversity board that is tucked into the channel of the clutch cover.



11. Tilt up the antenna board and unwrap its plastic insulator.

**Replacement Note:** Reuse the plastic insulator. If it is torn, use a single layer of Kapton tape to secure the insulator on the antenna board.



12. Disconnect both antenna cables by pulling the cable connectors straight up and off of the board.

**Replacement Note:** The black antenna cable connects to Main1, and the grey antenna cable connects to Aux1. Make sure to reinstall the protective cover, and secure it with Kapton tape.

**Replacement Note:** Inspect the length of both antenna cables on the rear housing. If either cable is pinched or damaged, AirPort and Bluetooth reception might be affected. If so, replace the rear housing.

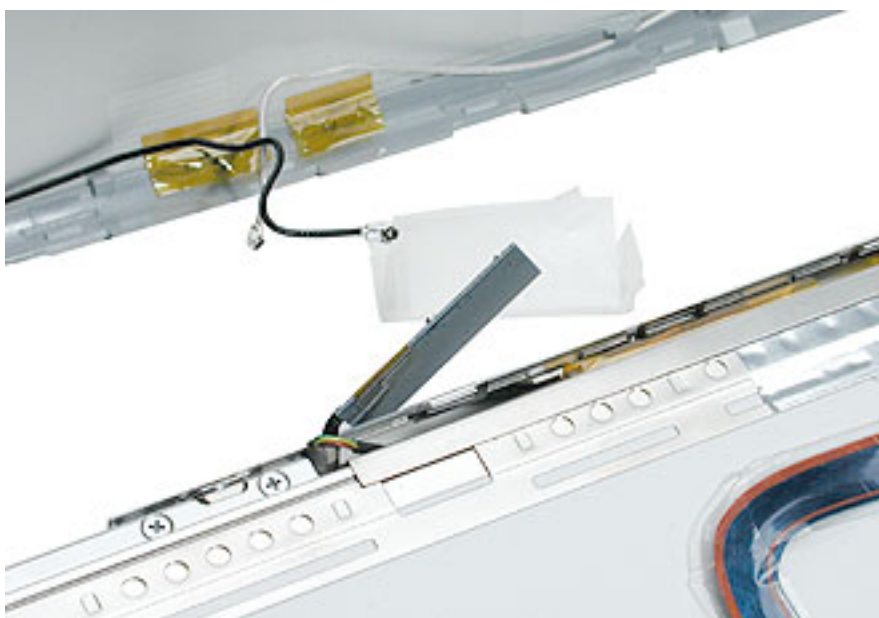

- 
- The rear display housing includes the housing, logo, attached spacers, and two antenna cables.

**Replacement Note:** When installing a new display rear housing, make sure the housing is clean and there are no foreign particles on the inner side of the housing.

**Important:** See “Display Rear Housing Adjustment” in the Adjustments section, if the rear housing looks identical to the image shown below, for instructions on removing the sets of shims and replacing the logo diffuser.

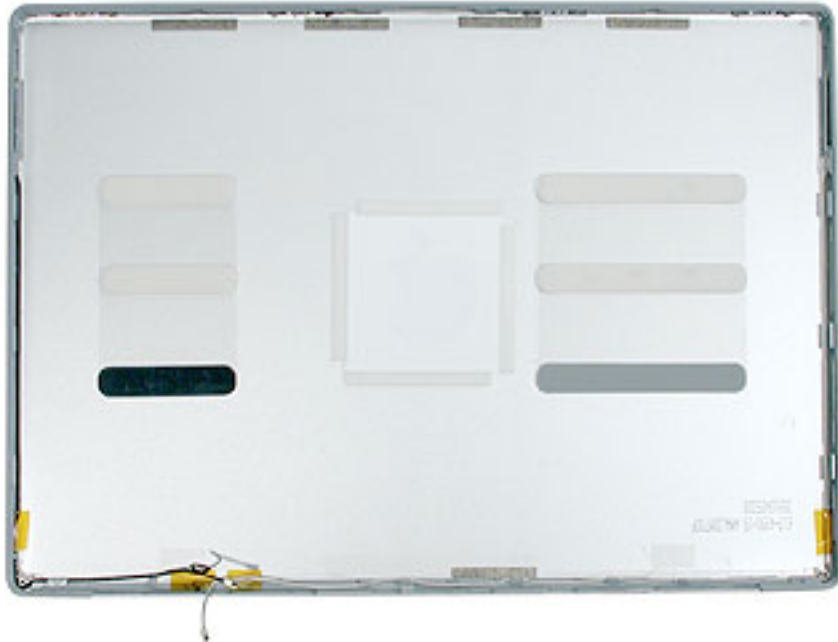

**Replacement Note:** Make sure the antenna cables are routed correctly and connected to the diversity board before securing the replacement rear housing on the the display assembly.

- Reassemble and test the computer.



# Display Hook Assembly

## Tools

This procedure requires the following tools:

- #0 Phillips screwdriver (magnetized)
- Soft cloth to protect the display face

## Part Location



## Preliminary Steps

Before you begin, remove the following:

- Battery
- Top case
- Display panel assembly
- Display rear housing

---

## Procedure

**Caution:** Handle the display assembly by the edges only. Avoid pressure on the back of the display (the white area of the LCD panel).

1. At the top edge of the display assembly, remove the four silver-colored screws that secure the display hook assembly to the display bezel.

**Caution:** The screws are quite delicate. To avoid stripping the screws, make sure that the screwdriver fits correctly and that steady pressure is applied when removing and reinstalling the screws.



**Note:** Depending on the date of manufacture, the hook assembly may have a somewhat different appearance, as shown below.



2. **Replacement Note:** To install the replacement hook assembly, press down on the pivot point of the hook to make sure the hook assembly is balanced and stays flat against the display bezel as it is secured by the screws.

Install the replacement hook assembly, and reassemble and test the computer.





# Inverter Board

## Tools

This procedure requires the following tools:

- Black stick (or other nonconductive nylon or plastic flat-blade tool)
- Soft cloth to protect the display face

## Part Location



## Preliminary Steps

Before you begin, remove the following:

- Battery
- Top case
- Display panel assembly
- Display rear housing

## Procedure

**Caution:** Handle the display assembly by the edges only. Avoid pressure on the back of the display (the white area of the LCD panel).

1. With the display assembly face down on a soft cloth, peel up the tape from the left end of the inverter board, if present.

**Replacement Note:** Some units have wire configurations with a 180-degree bend of the cables under the tape. Be sure to reinstall the cables in the same orientation.

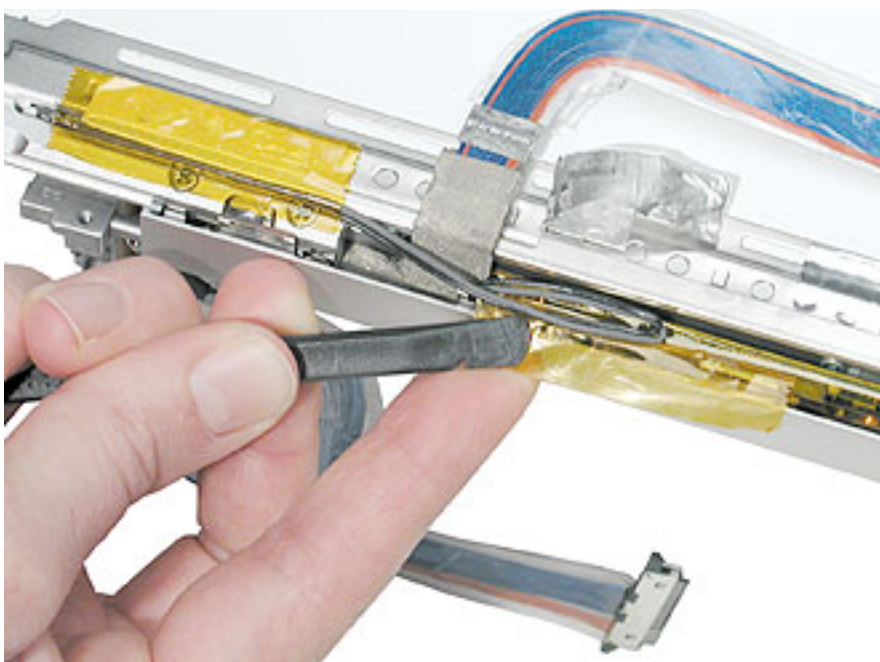

2. Lift the edge of the tape up to remove the wrapped inverter board.

**Caution:** The inverter board can be damaged if bent. Handle the board carefully to avoid bending the board.

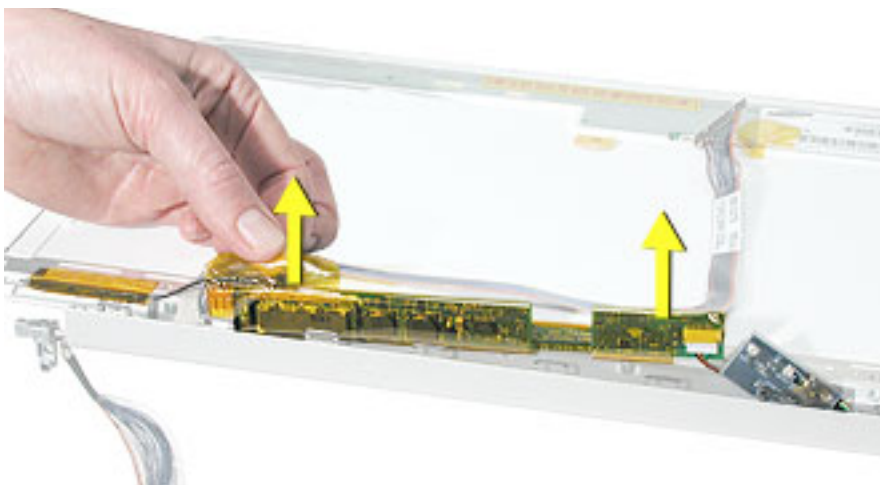



3. Disconnect the cable at the right end of the board.



4. Tilt up the inverter board, and disconnect the cable at the left end of the board.

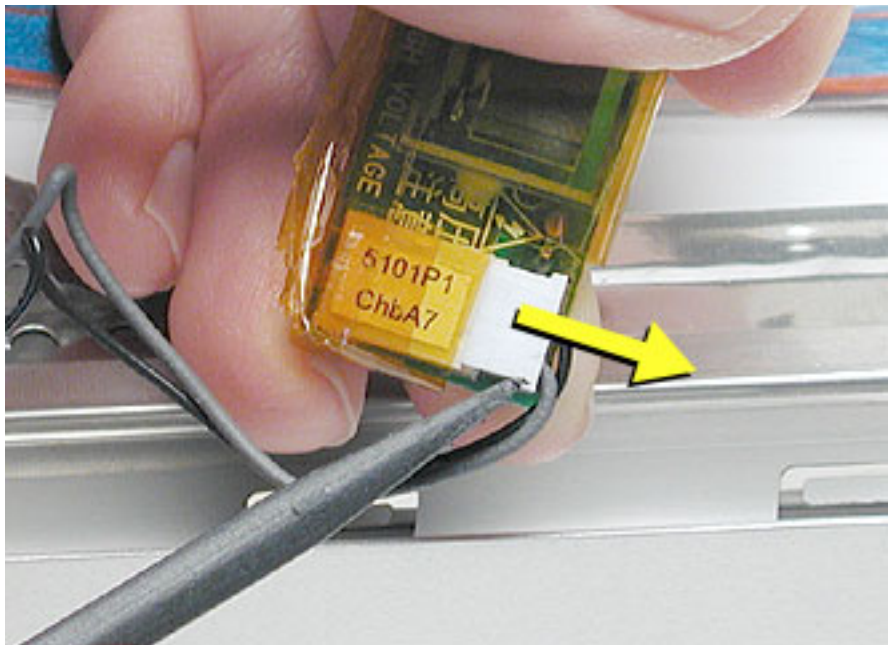

- 
5. Remove the inverter board from the display assembly.

**Replacement Note:** A replacement inverter board is wrapped in a mylar insulator. Do not unwrap the board. Handle the replacement board carefully during installation to avoid bending the board.



6. Reassemble and test the computer.



# Clutch Cover and Diversity Board

## Tools

This procedure requires the following tools:

- #0 Phillips screwdriver (magnetized)
- Black stick (or other nonconductive nylon or plastic flat-blade tool)
- Soft cloth to protect the display face

## Part Location

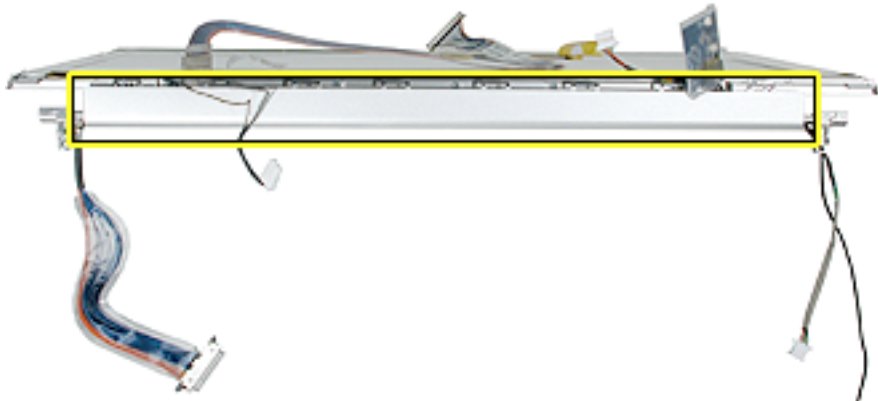

## Preliminary Steps

Before you begin, remove the following:

- Battery
- Top case
- Display panel assembly
- Display rear housing
- Inverter board

## Procedure

**Caution:** Handle the display assembly by the edges only. Avoid pressure on the back of the display (the white area of the LCD panel).

1. With the display face down on a soft clean cloth, remove the five screws that attach the clutch cover to the bezel.

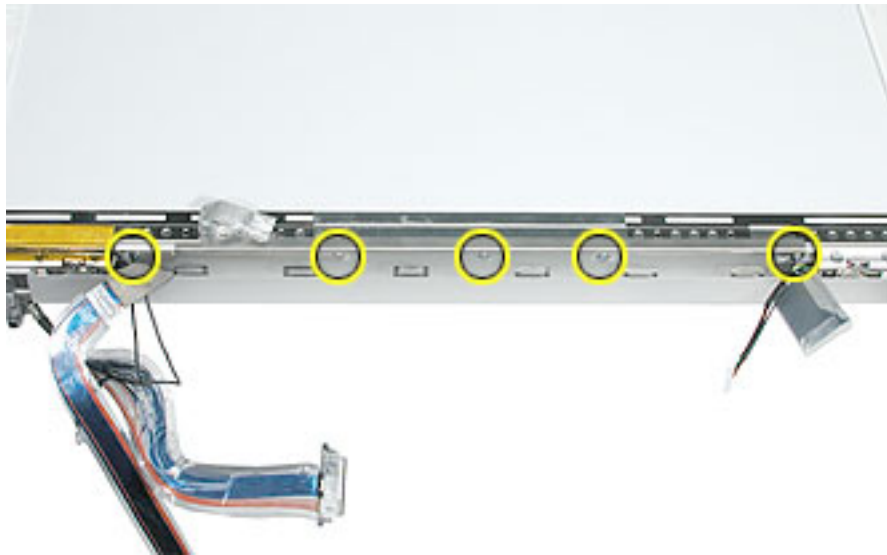

2. Pick up the bezel holder (may not be present on some units) and remove the screw from the open end of the ground wire at the antenna cable.

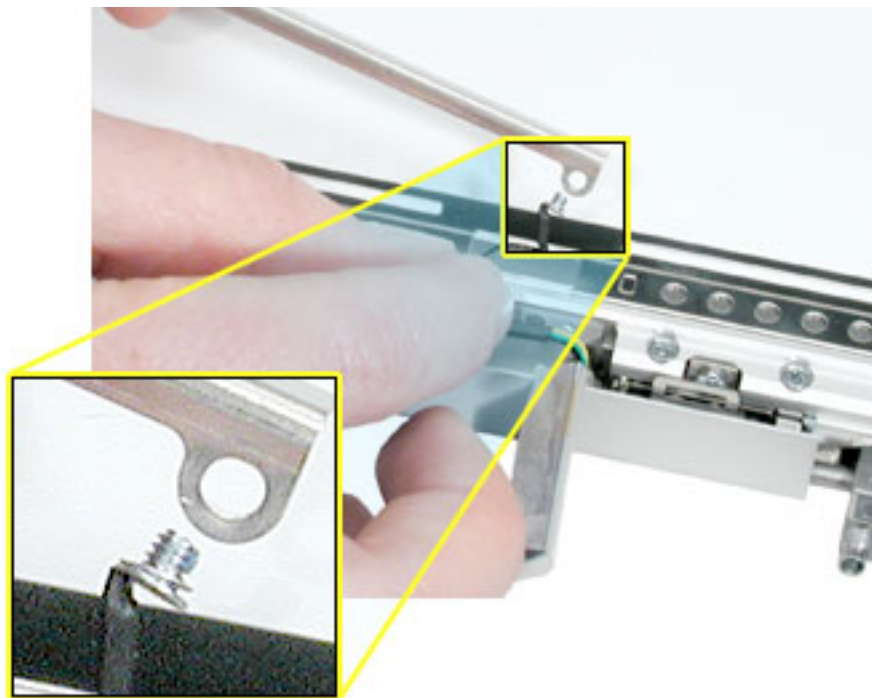

---

**Replacement Note:** When reinstalling the bezel holder, note its orientation in the display assembly (may not be present on some units).



3. Place the display on its top edge so you can access the clutch cover.

**Replacement Note:** Notice the orientation of the cables at the ends of the clutch cover. When replacing the clutch cover, make sure the cables are in the same orientation.



- Starting at the diversity board end of the clutch cover, pinch and squeeze the clutch cover with one hand while you use the other hand to press the clutch cover end off of the display assembly.



- Support the display as you remove the other end of the clutch cover.



- 
- Lift the diversity board with attached cables out of the clutch cover.

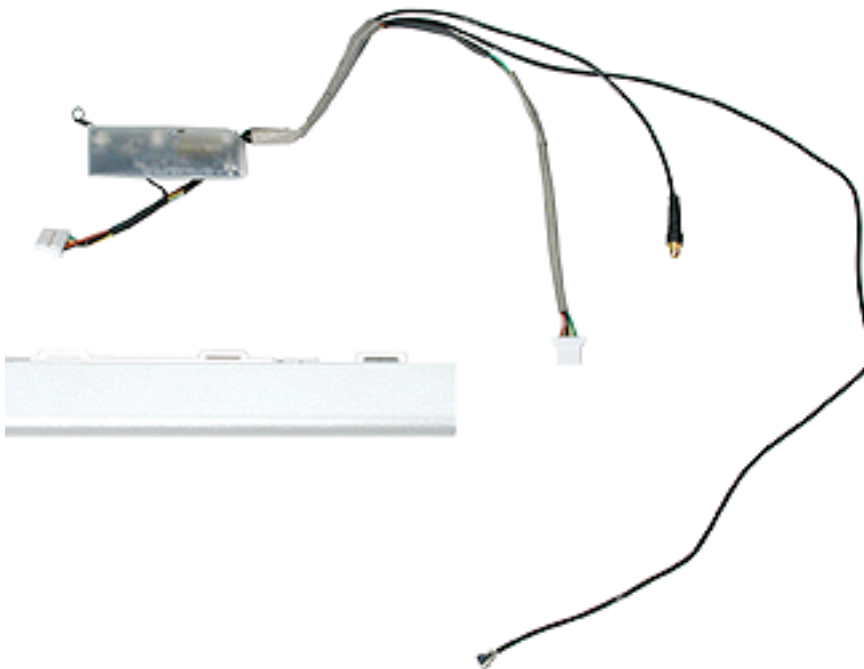

**Replacement Warning:** The clutches on the display bezel are not self-aligning. Do not remove the bezel clutches or their screws (see Display Clutch chapter).

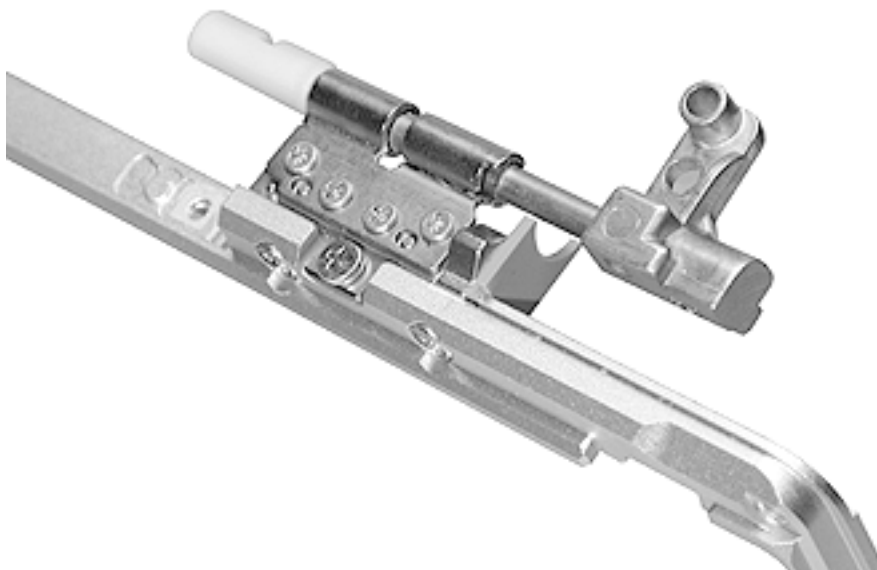

7. **Replacement Note:** When installing the clutch cover, make sure the screw holes align.



8. Reassemble and test the computer.





# LVDS Cable

## Tools

This procedure requires the following tools:

- Soft cloth to protect the display face

## Part Location



## Preliminary Steps

Before you begin, remove the following:

- Battery
- Top case
- Display panel assembly
- Display rear housing
- Inverter board
- Clutch cover and diversity board

## Procedure

**Warning:** To avoid damage, pooling, or white spots, handle the display assembly by the edges only. Avoid pressure on the back (white area) of the panel.

1. With the display assembly face down on a soft cloth, peel up the tape from the LVDS connector, and disconnect the cable from the LCD panel.

**Important:** When reconnecting the LVDS cable, make sure it is fully seated. To avoid white spots, secure the cable with one layer of Kapton tape only on the metal of the connectors. Do not allow the tape to adhere to the white back of the panel.



2. Peel up the tape securing the other end of the LVDS cable.

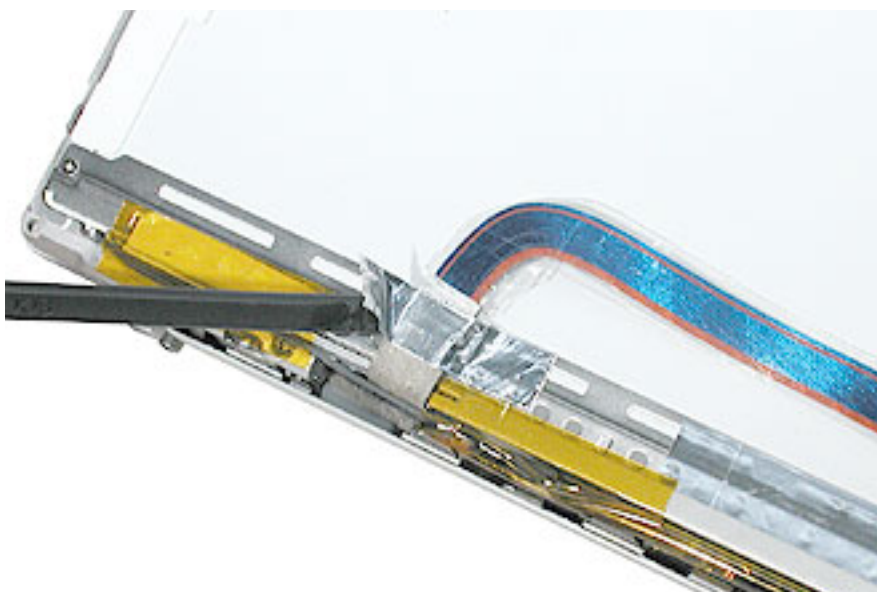

3. With the clutch cover removed, note the position of the LVDS cable on the clutch post. It is held in place with adhesive.

**Replacement Note:** Be sure to position the replacement LVDS cable under the clutch post as shown.

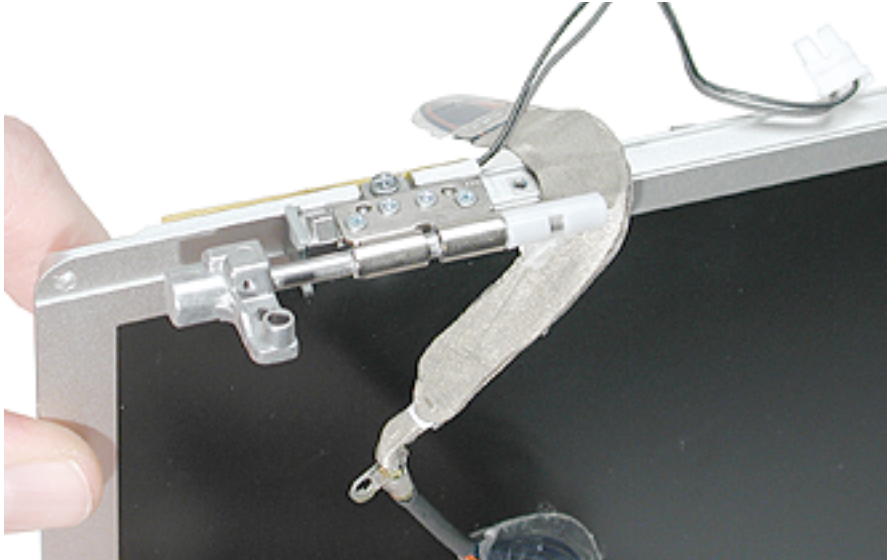

**Replacement Note:** Remove the paper strip covering the fresh adhesive on the replacement LVDS cable.



- 
4. Remove the LVDS cable from the display assembly.



5. Reassemble and test the computer.



# LCD Panel

## Tools

This procedure requires the following tools:

- #0 Phillips screwdriver (magnetized)
- Black stick 922-5065 (or other nonconductive nylon or plastic flat-blade tool)
- Isopropyl alcohol wipes (for removing adhesive residue)
- Soft cloth to protect the display face
- LCD Panel Spacer Kit 076-1069 (if not installed/included with replacement LCD panel)
- Bezel Adhesive Strips 922-6733 (if not included with replacement LCD panel)

## Part Location



## Preliminary Steps

Before you begin, remove the following:

- Battery
- Top case
- Display panel assembly
- Display rear housing
- Bezel holder (if present—see Clutch Cover and Diversity Board chapter)
- Inverter board (must disconnect inverter cable to LCD)
- Clutch cover and diversity board (optional)
- LVDS cable (must disconnect from LCD panel)

## Procedure

**Warning:** Handle the LCD panel by the edges only. To avoid damage, pooling, or white spots, do not press on the front or back of the LCD panel.

1. Position the display face down on a clean soft cloth.
2. Remove the two screws from both sides of the display.



3. Remove the four screws at the top of the display.



4. Hold the LCD and bezel together and turn it so the LCD faces up.
5. Carefully lift up on the top of the bezel to separate it slightly from the LCD.

**Warning:**

- Adhesive holds the bottom of the LCD and bezel together. Do not lift the bezel too far or damage to the LCD frame will result.
- If too much pressure is applied to the bezel, it can be bent out of alignment.



6. Guide a black stick into the gap between the metal LCD frame and the bezel. Carefully move it back and forth, gradually going deeper, to release the adhesive.

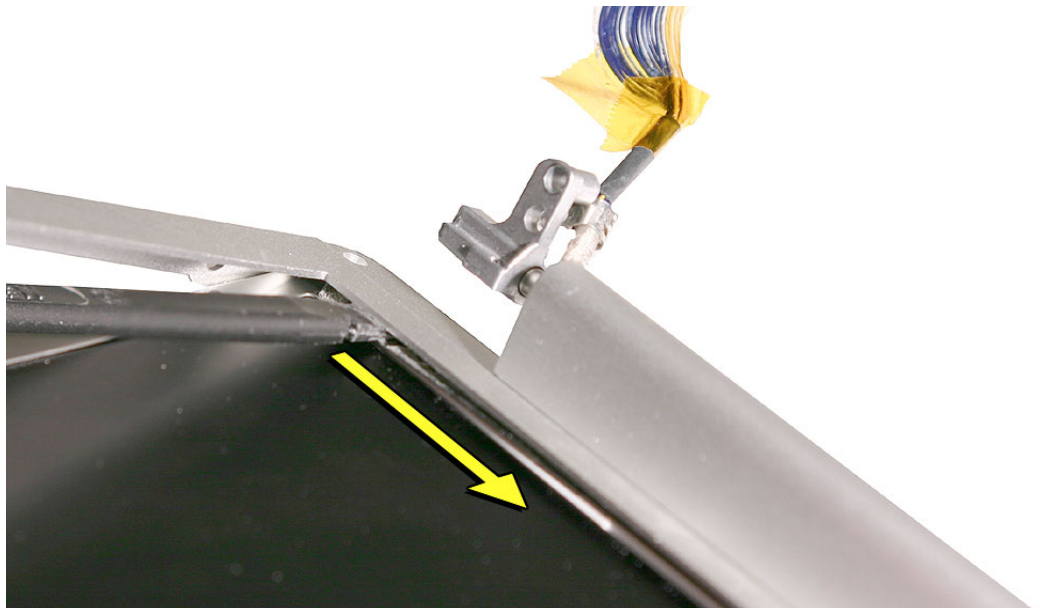

7. Lift the bezel off of the LCD panel.



### **If installing a replacement LCD panel**

1. Verify that three spacers are installed. If not, you need to install them—one along each side and one longer one along the top of the LCD panel.

**Important:**

- Do not install spacers if they are already installed on the LCD panel.
- When installing spacers, be careful to align them properly with the screw holes.



2. **Important:** If you are installing a replacement LCD panel, you must either replace the display rear housing or perform an adjustment to the shims and diffuser on the existing rear housing. **Note:** All replacement LCD panels include the new diffuser for installation on the rear housing. Refer to “Display Rear Housing Adjustment” in the Adjustments chapter for complete details.



## Transfer or verify the sleep magnet installation

1. The round magnet on the back of the LCD panel triggers the computer's sleep sensor.
2. If you are replacing the LCD panel, transfer the magnet to the new panel. Do not transfer the half-donut shaped holder, if present. If the holder came installed on the replacement panel, install the magnet in the center.
3. **Important:** Secure the magnet with a single piece of Kapton tape. To avoid pooling or white spots, do not stretch the tape tight, or press down on the back of the LCD panel.  
Verify or install the magnet approximately 6.5 cm from the top edge of the LCD panel, and 1 cm from the left edge of the L-shaped panel strip.

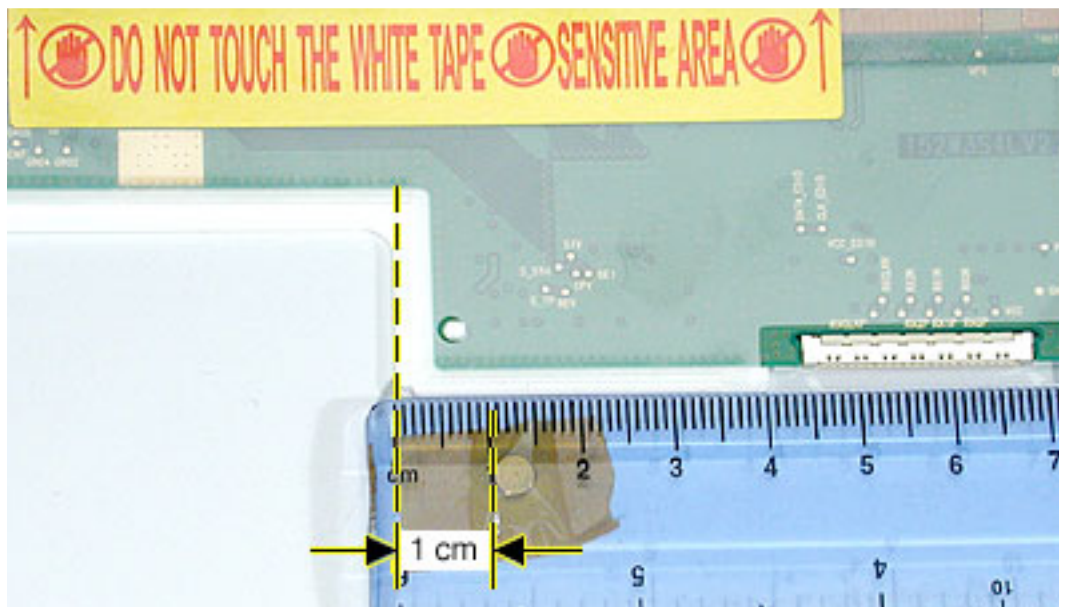
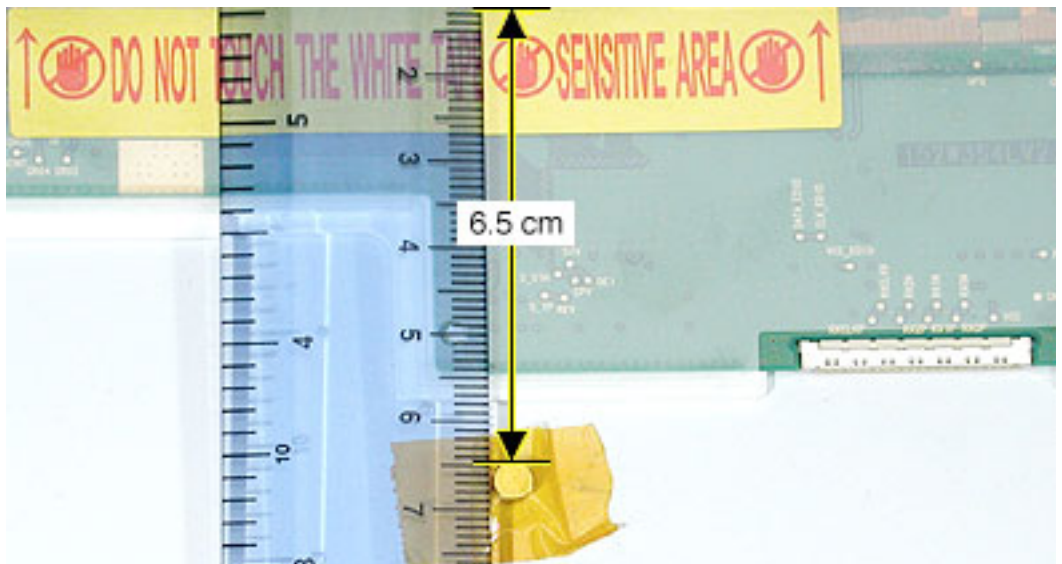

### If reinstalling the bezel

1. Use Isopropyl alcohol wipes and a black stick to remove any residual adhesive along the lower inside edge of the bezel. Rub the wipes vigorously over the adhesive and scrape with the black stick. Verify that the adhesive is completely removed so that there are no clumps of adhesive remaining that will create an uneven surface.

**Warning: Sharp edges may be present.**

2. Install the two replacement adhesive strips along the inside bottom edge. Peel an adhesive strip from its backing, carefully position as shown below, and apply. Remove the protective material over the adhesive strips before installing the LCD.

**Important:** Do not allow anything to come in contact with the adhesive while positioning. The adhesive sticks to anything it touches, such as fingers, and will pull off its backing and stretch out of shape.

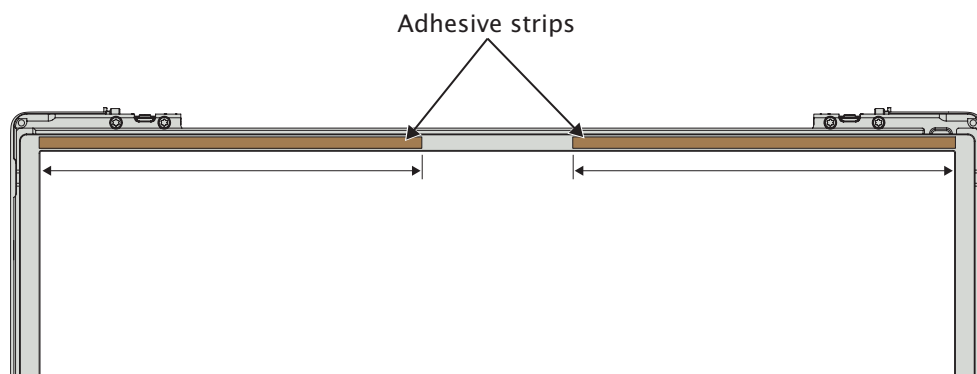

### If installing a replacement bezel

1. Remove the protective material over the adhesive before installing the LCD. If adhesive is not present, install as instructed above.

### Reassemble and test the computer

**Important:** After the computer is reassembled, verify that the magnet is in the correct location by closing the display while the computer is running. The computer should go to sleep.



# Display Bezel

## Tools

This procedure requires the following tool:

- Torx T8 screwdriver (if transferring clutches to a replacement bezel)

## Part Location

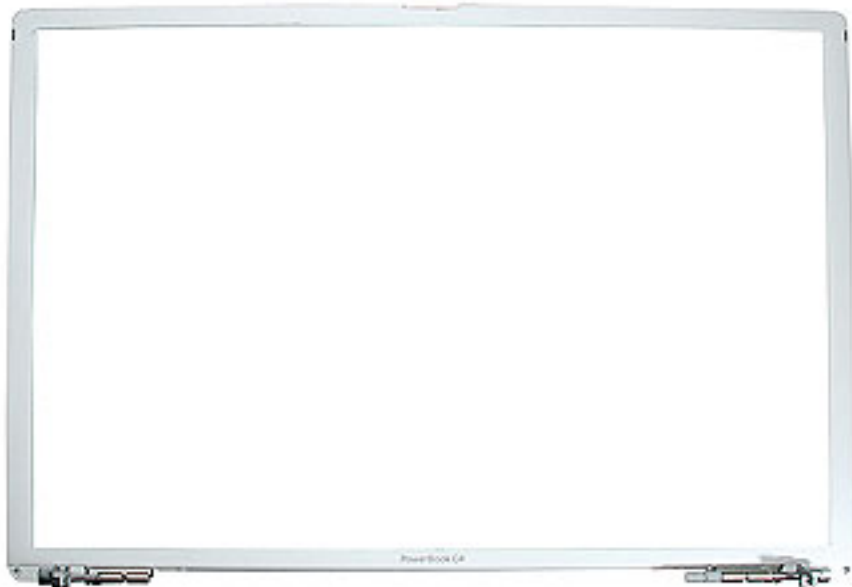

## Preliminary Steps

Before you begin, remove the following:

- Battery
- Top case
- Display panel assembly
- Display rear housing
- Inverter board
- Clutch cover and diversity board
- LVDS cable
- LCD panel

---

## Procedure

**Important:** Do not remove or loosen screws on the clutches. The clutches are not self-aligning and even a 0.3 mm shift will be noticeable.

**Important:** If uneven pressure is applied to the bezel, it can be bent out of alignment. Avoid twisting the bezel.

With all preliminary steps performed, the bezel is the remaining part.

## Replacement Procedure

### If installing a replacement bezel

1. Remove the clutch block and clutch assembly on the replacement bezel, if present. They may not be aligned for the computer and will not be used.
2. Transfer the clutch blocks with clutches attached, to the replacement bezel, by removing the three T8 screws on each one.

**Important:** Do not remove or loosen screws on the clutches. The clutches are not self-aligning and even a 0.3 mm shift will be noticeable.

3. Remove the adhesive backing along the bottom inside bezel edge. If adhesive is not present, follow the procedure in the LCD chapter to install.

### If reinstalling the bezel

1. Follow the procedure in the LCD chapter to remove the residual adhesive, and to install new adhesive.

### To install the bezel

1. Place the bezel face down on a table with the clutches positioned over the edge.



---

**Important:**

- If installing a replacement LCD panel, verify that three spacers are installed (see LCD Panel chapter).
  - Handle the LCD panel by the edges only. Avoid pressure on the back of the panel (the white area of the LCD panel).
2. Holding the sides of the LCD panel and the sides of the bezel, carefully align the LCD panel over the inner edges of the bezel.



3. Lower the LCD panel and press its outside edges and the bezel into place.
4. Reassemble and test the computer.



# Display Clutch

## Tools

This procedure requires the following tools:

- #0 Phillips screwdriver (magnetized).
- Torx T8 screwdriver (if transferring to a replacement bezel)

## Part Location

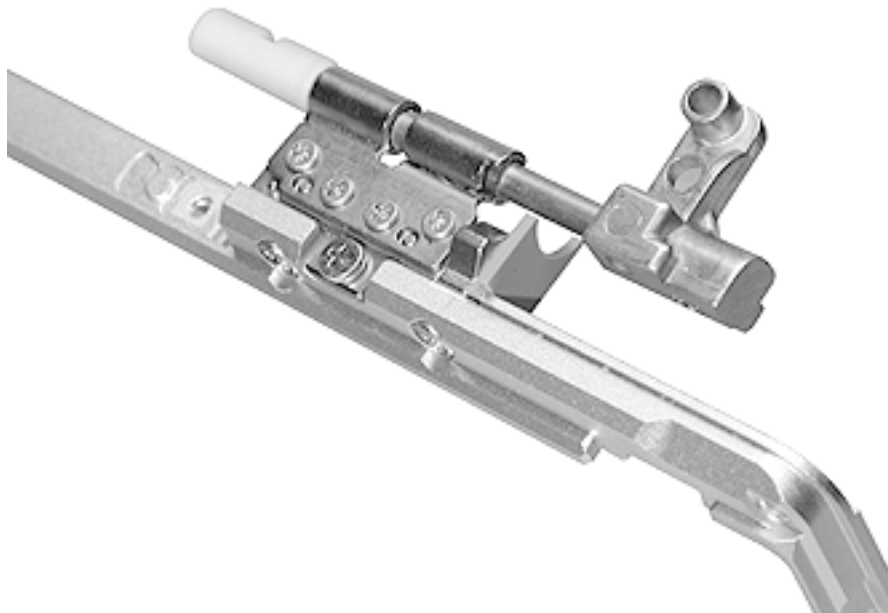

## Preliminary Steps

Before you begin, remove the following:

- Battery
- Top case
- Display panel assembly
- Display rear housing
- Inverter board
- Clutch cover and diversity board

## Procedure

**Important:** Do not remove or loosen screws on the clutches, except in the manner described below. The clutches are not self-aligning and even a 0.3 mm shift will be noticeable.

**Important:** If too much pressure is applied to the bezel, it can be bent out of alignment. Avoid flexing the bezel.

### If transferring clutches to a replacement bezel

**Important:** Do not remove or loosen screws on the clutches.

1. Remove the two clutch blocks (if installed) on the replacement bezel by removing the three T8 screws that secure each one. These will not be used.
2. Remove the corresponding three screws for each clutch block on the bezel being replaced, and transfer them with the clutches intact to the replacement bezel.

### If replacing clutches

**Important:** To maintain factory alignment, remove and replace only one clutch at a time. Do not touch the screws of the other clutch, so that it maintains its alignment position from the factory.

When the replacement clutch is installed, place the display back into the bottom case and secure the clutch that was not removed. Check the replaced clutch for alignment. If needed, remove the display, adjust the installed clutch, and repeat until properly aligned.

Repeat this procedure for the other clutch, if replacing.

1. Remove the four screws from the display clutch.

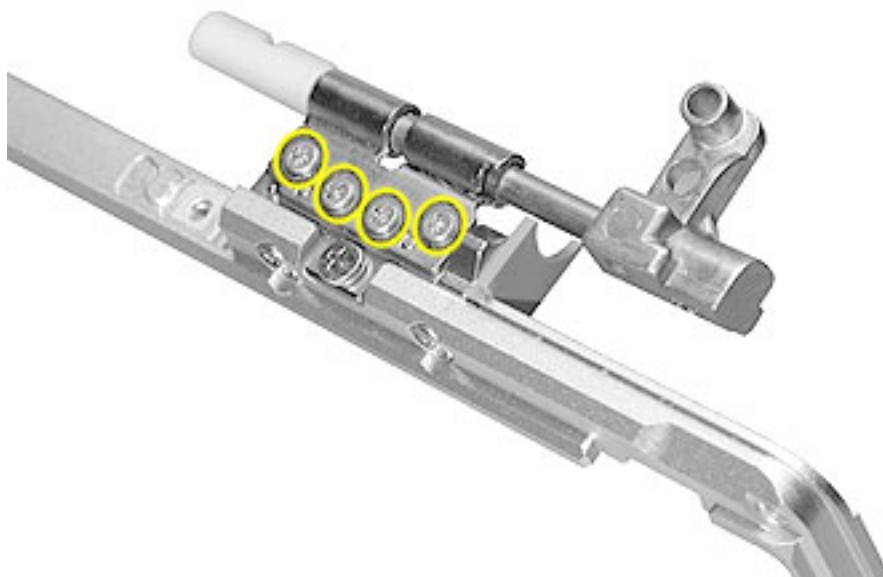

2. Note the thin metal shim that fits between the clutch and the bezel.

**Important:** Some units do not have shims. Do not install shims on these units.

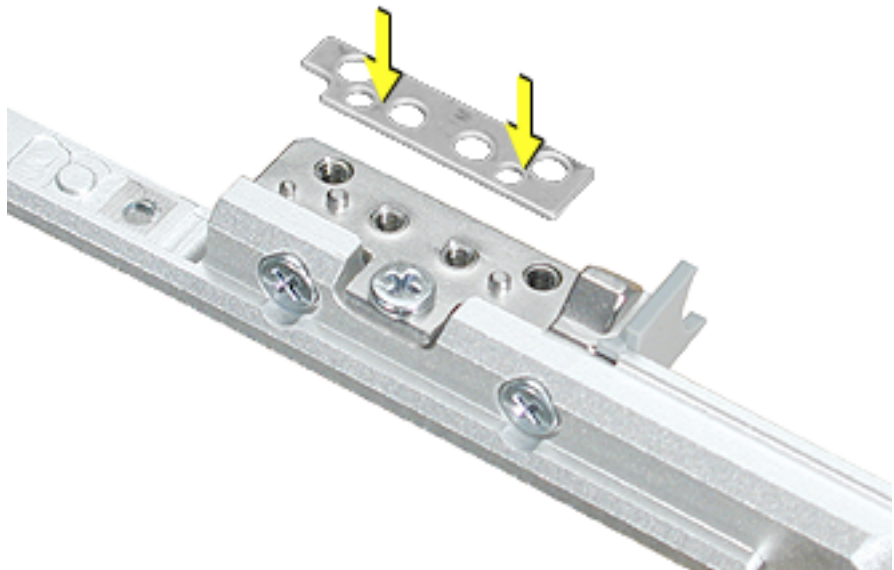

3. Make sure the shim is in place and pressed against the bezel before installing the replacement clutch.

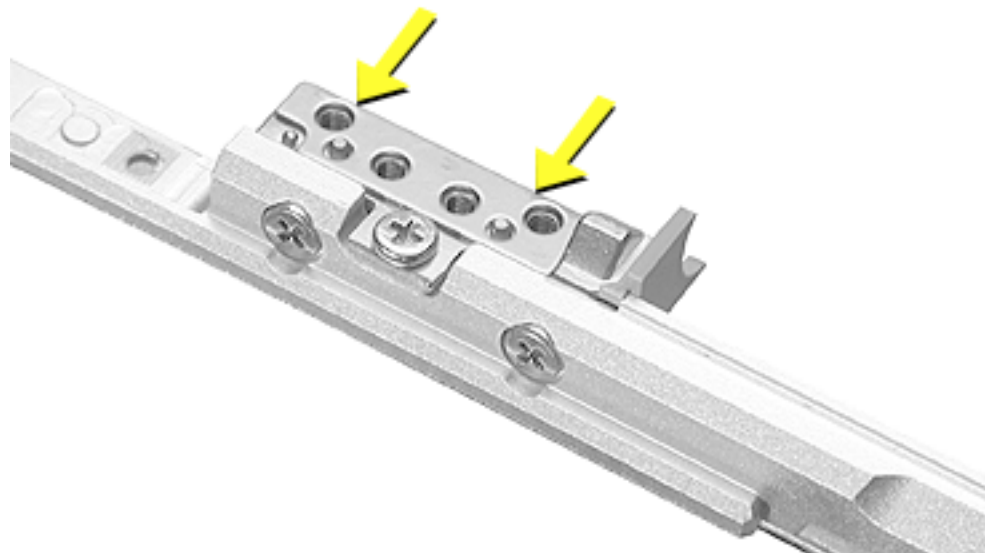



4. When installing the replacement clutch, be sure all openings align with the pins or holes on the shim and bezel.
5. Hold the clutch firmly against the bezel when installing the screws.

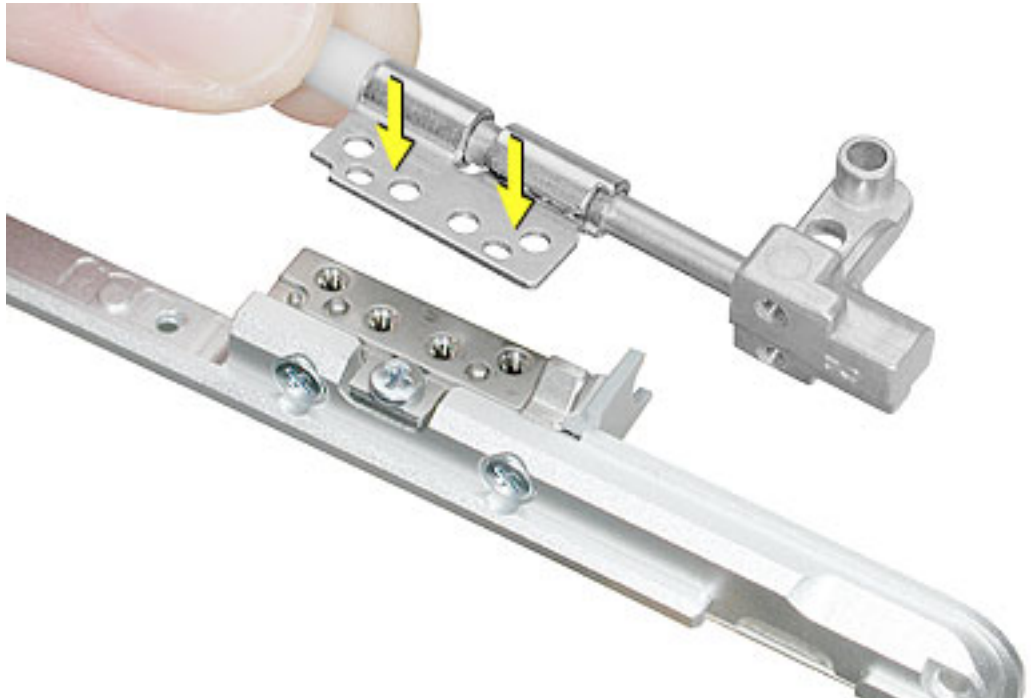

6. Reassemble and test the computer.



## Troubleshooting

---

PowerBook G4 (15-inch FW 800)  
PowerBook G4 (15-inch 1.5/1.33GHz)



# General Information

## Wire and Flex Cables

With the very thin enclosure design and dispersed circuit board, a large number of flex cables are used in this computer. In addition, there are a variety of wire cable harnesses as well. Many of these cables carry multiple types of signals.

Here is a list of the cables and the signals that run across them. If you notice a group of functions not working, it is likely that the cable is not properly inserted or the connector is damaged.

<b>Cable or Flex Cable Name</b>	<b>Signal(s) Running Through It</b>
AirPort Extreme/Bluetooth antenna assembly (in display housing to diversity board)	AirPort/Bluetooth radio signals
AirPort Extreme antenna cable extension (to AirPort card cage)	AirPort radio signal
AirPort Extreme Flex (to logic board)	AirPort data / power
Ambient Light Sensor (Left) cable	Light data from left side
Bluetooth cable (to Sound/DC-in board)	Bluetooth data/power
Blower, left cable (to logic board)	Power/control for left blower
Blower, right cable (to logic board)	Power/control for right blower
Hard drive flex (to logic board)	Hard drive control, data, and power
Inverter cable (from display panel)	High voltage for backlight
Inverter/antenna cable (to logic board and wireless modules)	Display backlight control AirPort radio signal Bluetooth radio signal
Keyboard backlight cable (on top case)	Power to keyboard backlight LEDs
Keyboard flex (from keyboard)	Keyboard data and status lines
LVDS cable (from display housing)	Video data to display panel

<b>Cable or Flex Cable Name</b>	<b>Signal(s) Running Through It</b>
Main battery cable	Connects main battery to logic board
Modem flex (to logic board)	Modem control and data
Optical drive flex (to logic board)	Optical data, power, and control signals
PC Card cage flex (to logic board)	PC card data and power
Power Button cable	Power-on signal
RJ-11 cable (to modem)	Analog phone signal
Right USB flex	Right USB signal and power
Sleep LED cable (to logic board)	Power to sleep LED
Sound/DC-in board flex (to logic board)	Bluetooth data Left USB connector Left ambient light sensor Digital audio in/out
Sound/DC-in board cable harness (to logic board)	Power to system and main battery
Speaker assembly wire harness	Left speaker Right speaker Mid range speaker Internal microphone
Trackpad flex	Trackpad data and power Power on button Keyboard backlight power Sleep sense signal

---

## Hardware Troubleshooting Tools and Tips

### Apple Hardware Test 2.0.6 (AHT)

Starting with the PowerBook G4 (17-inch), the Apple Hardware Test software will be incorporated into the Software Install and Restore DVD. There is no separate CD for this diagnostic.

**Note:** Currently, these DVD images are not posted on Service Source online.

Previously, the C key was held down to boot into the diagnostics. With the combined DVD, this action will boot into the software restore section of the disk. In order to access the AHT on the DVD follow these steps:

1. Insert the DVD named “PowerBook G4 15-inch and 17-inch Software Install and Restore” that came with your computer.
2. Hold down the Option key and restart the computer.
3. Click Apple Hardware Test volume in the startup manager.

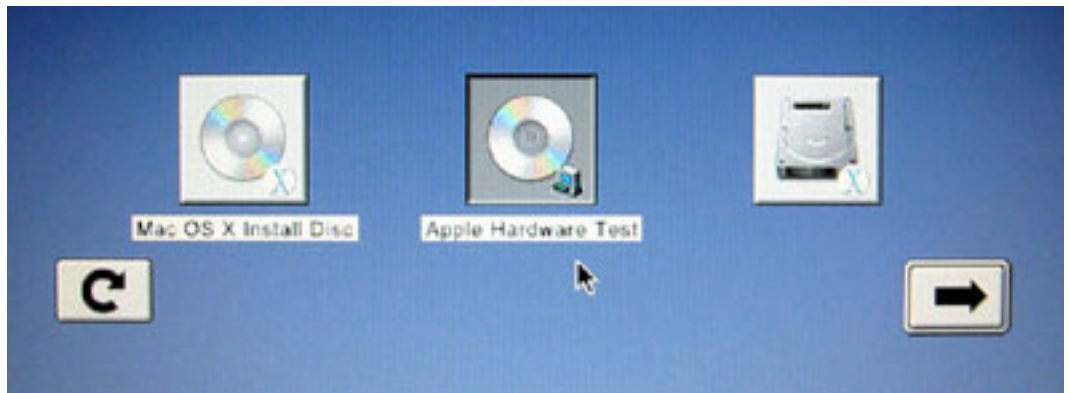

4. Click the arrow that points to the right.
5. Follow the on-screen instructions.

**Note:** Apple Hardware Test 2.0.1 and later is not backwards compatible with PowerBook computers prior to the PowerBook G4 (1Ghz/867Mhz).

### Apple Service Diagnostic (ASD)

Since the PowerBook G4 (15-inch FW 800) is a Mac OS X only system, MacTest Pro software does not work on this computer. As a replacement, Apple System Diagnostic will be delivered to service providers and can be downloaded from Knowledge Base article 112125: Service Diagnostics Matrix.

**Important:** ASD is not backward compatible with PowerBook computers prior to the PowerBook G4 (1GHz/867MHz).

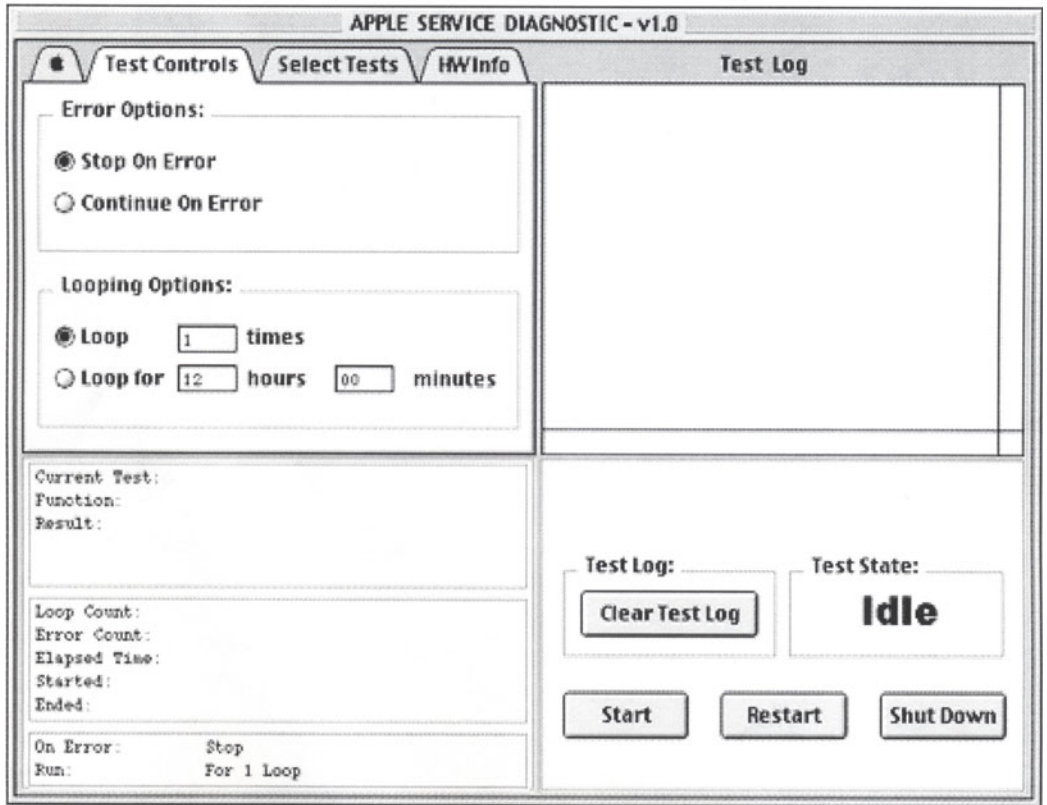

Apple Service Diagnostic Main screen

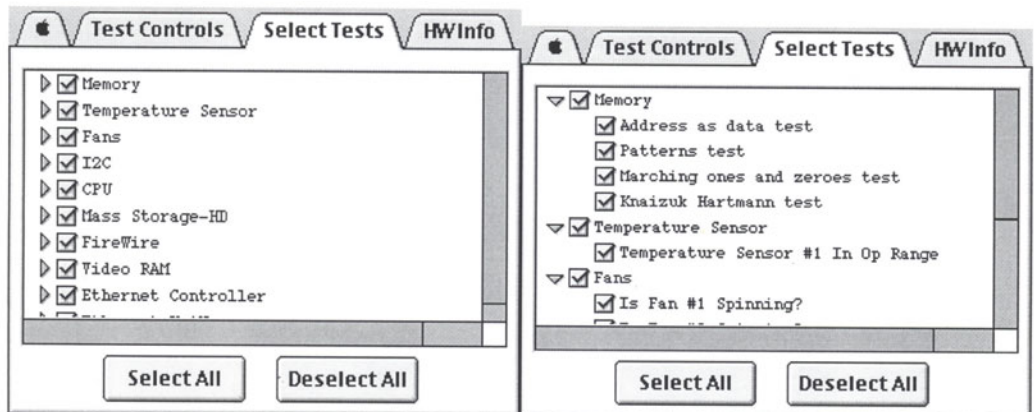

Apple Service Diagnostic Select test tab

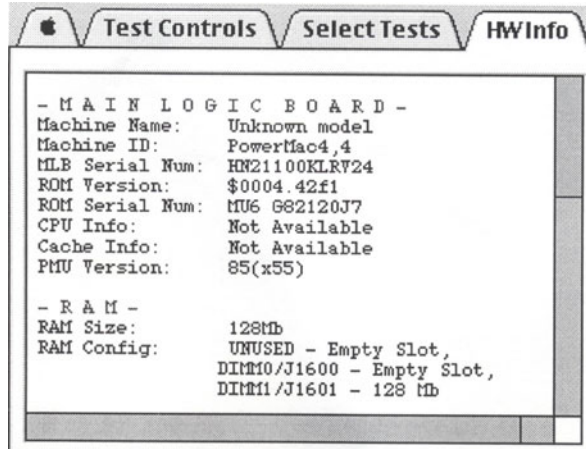

**Apple Service Diagnostic Hardware info tab**

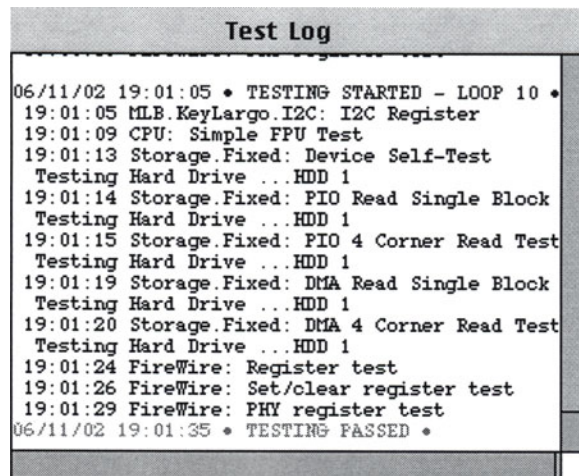

**Apple Service Diagnostic Test log tab**

## Resetting the Power Manager Unit (PMU)

The PMU reset button has been removed from the logic board. Use the following key combination procedure or the PMU Reset pad (see PMU Reset pads on logic board, below).

1. If the computer is on, turn it off.
2. Reset the power manager by simultaneously pressing and then releasing Shift-Control-Option-power button. Do not press the fn (Function) key while using this combination of keystrokes.
3. Wait 5 seconds.
4. Press the power button to restart the computer.

## Power-on pads on logic board

With the top case removed, the power-on button is disconnected. Instead of having to reconnect the top case to turn on the system, there are two pads on the logic board when shorted together (with a tool like the head of a flat blade screwdriver) is the equivalent to pushing the power-on button.

These pads are located near the edge of the logic board, just above center of the hard drive. It is marked POWER BUTTON. The pads are separated with a vertical white line.

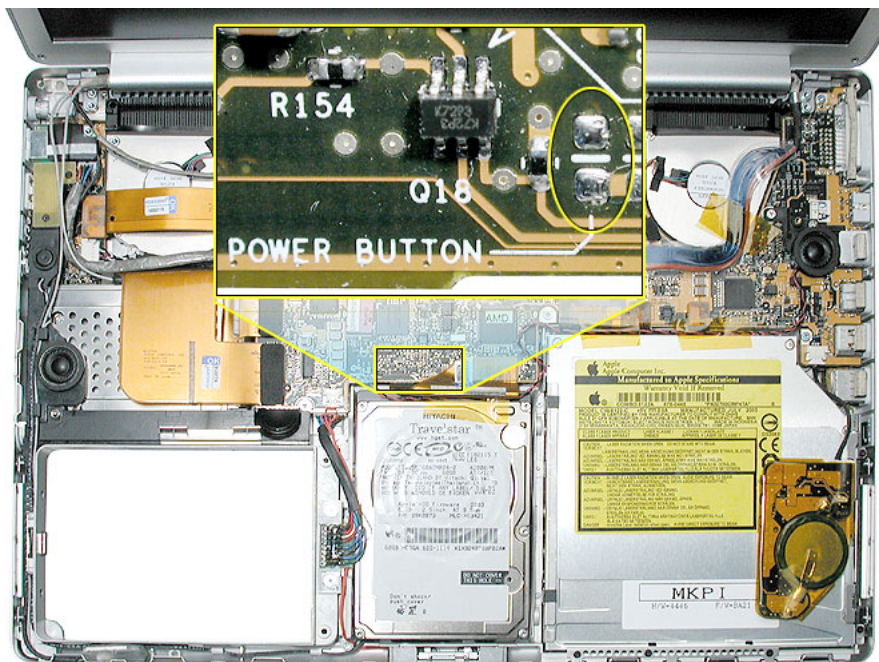



## PMU Reset pads on logic board

In addition to the power-on button pads on the logic board, there are pads for PMU reset. These buttons work when their pads are shorted together (with a tool like the head of a flat blade screwdriver). They are marked PMU RESET. The pads are separated with a white horizontal line between the pads.

These pads are located near the edge of the logic board, just above center of the hard drive.

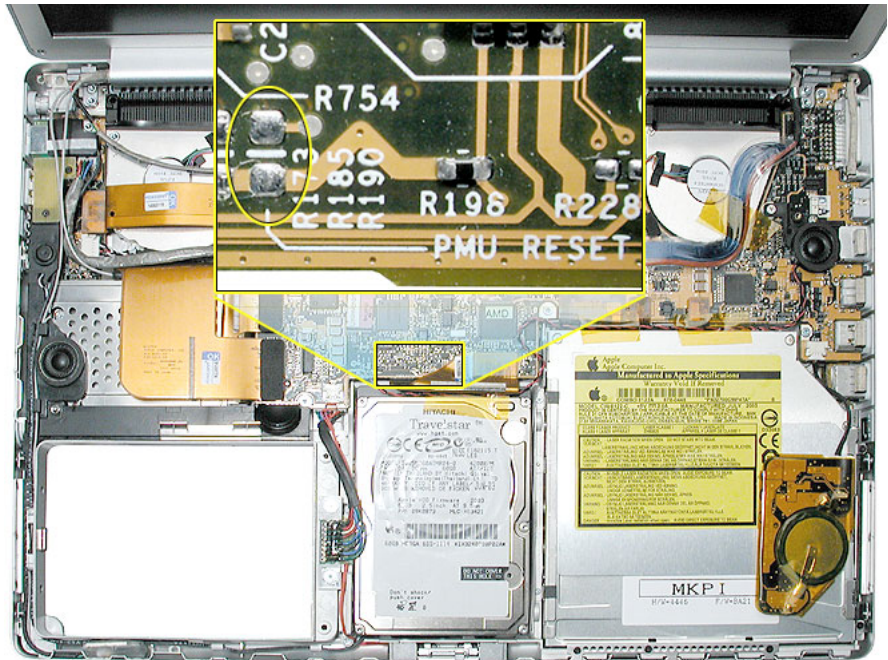

## Caps lock LED power check

There are situations when the system is giving indications that it is shut down (no hard drive access, screen is dark, no blower, and so on). However, the logic board may still be running. In this case, the logic board is drawing power and generating heat.

**Warning: In this situation, if the computer is put in an enclosed environment like a carrying bag, the computer can overheat.**

Check this situation by pressing the caps lock key. If the LED glows, the PMU is running on the logic board. After pressing the caps lock key and perhaps other methods of waking it up fails, hold the power button down for six seconds to force a shut down of the computer. Restart the system to check if it boots up normally.

---

## Software Troubleshooting Tips and Tools

### Mac OS X only

Starting with the PowerBook G4 (17-inch), the system will no longer boot into Mac OS 9. Mac OS 9 applications can still be used, but only in the Mac OS X classic mode.

In locations such as the Startup Disk system preference pane, a Mac OS 9 folder will not show up as an option.

### Login window and account

Mac OS X requires at least one user account to be established. This is the Administrator's account. By default, the Accounts system preference pane has the "Log in automatically [Admin's name]" check. This automatic login setting allows the system to boot into the Finder without having a log-in prompt.

However, if this box is not checked, you will need a password to get to the Finder. In addition, you will need to create a user account after you re-install system software.

### Customer forgot password

If the customer forgot the password for the computer:

1. Insert the Software Install and Restore DVD.
2. Restart the computer while holding down the C key on the keyboard.
3. When the installer appears, choose Reset Password from the Installer menu.
4. Follow the on-screen instructions.

### Safe Mode

The Mac OS X that shipped with the PowerBook G4 (15-inch FW 800), has a new startup state called Safe Mode.

Safe Mode is the state Mac OS X is in after a Safe Boot. A Safe Boot is a special way to start Mac OS X when troubleshooting. Starting up into Safe Mode does three things to simplify the startup and operation of your computer:

1. It forces a directory check of the startup (boot) volume. It is identical to using Disk Utility's Repair Disk or the `fsck -fy` terminal command.
2. It loads only required kernel extensions (some of the items in `/System/Library/Extensions`).
3. It runs only Apple-installed startup items (some of the items in `/Library/Startup Items` and `/System/Library/Startup items` - and different than login items).

Taken together, these changes can work around issues caused by software or directory damage on the startup volume.

---

To start up into Safe Mode (to Safe Boot), do this:

1. Be sure the computer is shut down.
2. Press the power button.
3. Immediately after you hear the startup tone, press and hold the Shift key.

**Note:** The Shift key should be held as soon as possible after the startup tone but not before.

4. Release the Shift key when you see the screen the gray Apple and progress indicator (looks like a spinning gear).

During the startup, you will see "Safe Boot" on the Mac OS X startup screen (shown below). To leave Safe Mode, restart the computer normally, without holding any keys during startup.



### Knowledge Base Articles

These troubleshooting articles can be searched from <http://www.apple.com/support>.

106692 Mac OS X: Troubleshooting Installation and Software Updates

106693 Mac OS X: Troubleshooting Installation From CD-ROM



# Hardware Symptom Charts

## How to Use the Symptom Charts

The Symptom Charts included in this chapter will help you diagnose specific symptoms related to the product.

The steps to solve a symptom are listed sequentially. You might not need to perform every step before the symptom is solved. Start with the first step, and then test for the symptom. If the symptom persists, replace any modules you removed, go to the next step, and test again. Continue down the list until the symptom is solved.

---

## Power Adapter Note

The system was designed to use the Apple 65-Watt Portable Power Adapter that came with your computer. The previous 45-Watt Apple power adapter for PowerBooks is plug compatible, but it may not provide sufficient power during some activities and power may be drawn temporarily from the battery. You can identify the Apple 65W Power Adapter by its markings (see photo).



Under low battery or no battery situations, the 45 watt power adapter may not be able to provide enough power to properly support the system.

Although you may have used the 45 watt adapter with a PowerBook G4 (1GHz/867MHz) without trouble, the peak power requirements of the PowerBook G4 (15-inch FW 800) is much higher and will have a higher chance of encountering compatibility issues.

---

## Startup

### **The computer will not power on (no blower movement, hard drive spin up and display is not lit)**

1. Remove any connected peripherals and eject any PC card.
2. Check that the battery has enough charge to start the computer by pressing the button next to the LEDs on the battery. At least one LED must light solid (not flashing).
3. Connect a known-good Apple 65W Portable Power Adapter (661-3048) and power cord or plug to a known-good power outlet; make sure the DC plug is firmly inserted. The DC plug should light up, if not, replace Sound/DC-in board.

**Important:** The Apple 65W Portable Power Adapter is highly recommended to be used with the PowerBook G4 (15-inch FW 800) computer. The adapters can be identified by 65W in the name and markings, and the metal securing-stud on the plug connector. Although previous 45W power adapters (see Knowledge Base article 88231 PowerBook and iBook: Apple Power Adapter) are plug compatible with the PowerBook G4 (15-inch FW 800), it may not provide sufficient power during some activities and power may be drawn temporarily from the battery.

4. Try powering up without the battery installed (only works with 65W power adapter). If it boots, replace battery connector cable.
5. Perform the keyboard PMU reset procedure described in the Troubleshooting Aid section.

**Warning: Resetting the power manager will permanently remove a RAM disk, if present, and all of its contents. You will also need to reset the date and time (using the Date & Time system preference pane).**

6. Press Caps Lock key to see if key light comes on. If it does, hold power button down for six seconds to shut down the computer and restart.
7. If it still doesn't start, verify power button cable is connected properly to top case flex cable assembly and that the flex cable is connected correctly to the logic board, if power button is not functioning correctly or damaged, replace the top case.
8. Disconnect keyboard completely. Inspect connectors. Restart with keyboard disconnected.
9. Remove any additional RAM.
10. Remove AirPort Extreme Card.
11. Verify Sound/DC-in board cable is securely connected.
12. Try disconnecting the AirPort Extreme flex connector from the logic board and start the computer. If it starts, shut it down and check the flex cable connector and the connector on the logic board and replace the damaged parts.

- 
13. Repeat step 12 with the following flex cables one at a time, reconnecting each before proceeding to the next cable:

- Sound/DC-in flex cable
- Hard drive flex cable
- Optical drive flex cable
- PC card cage flex cable
- Keyboard flex cable
- Trackpad flex cable
- Right USB flex cable
- Modem flex cable

If the computer starts up, inspect the flex cable connector and its connector on the logic board for damage and replace the damaged parts.

14. Try known-good Sound/DC-in board.
15. Replace logic board.

### **Memory error message “The built-in memory test has detected an error” appears on the screen**

1. Run Apple Service Diagnostic Test. Note: If the failure is intermittent, run Apple Service Diagnostic Test in loop mode (check looping options under Test Controls tab and select only the RAM test under the Select Tests tab) for an extended time to test the memory.
2. If the test can't find the memory or finds bad memory, inspect the bad DIMM. Verify proper memory is being used. The PowerBook G4 (15-inch FW 800) uses PC2700 (also called DDR333) DDR SDRAM SO-DIMMs with a maximum height of 1.25-inch (30 mm). If improper memory is being used replace it. Otherwise, try reseating the DIMM and retest. If still reported as bad, replace it.
3. Check the memory connector for damage (retention arms broken, connectors bent or missing, connector lifted from logic board). If damage is detected replace the logic board.

**Blue screen appears (a spinning disc cursor may also be visible),  
Prohibitory Sign appears,  
Restart dialog box appears (Mac OS X 10.2 kernel panic window), or  
Gray screen during startup**



**Prohibitory Sign**

You need to restart your computer. Hold down the Power button for several seconds or press the Restart button.

Veillez redémarrer votre ordinateur. Maintenez la touche de démarrage enfoncée pendant plusieurs secondes ou bien appuyez sur le bouton de réinitialisation.

Sie müssen Ihren Computer neu starten. Halten Sie dazu die Einschalttaste einige Sekunden gedrückt oder drücken Sie die Neustart-Taste.

コンピュータを再起動する必要があります。パワーボタンを数秒間押し続けるか、リセットボタンを押してください。

#### **Kernel Panic dialog box**

1. Make sure all external devices are disconnected and any PC card ejected. If kernel panic goes away, troubleshoot the external device by reconnecting each device until the panic occurs.
2. If there are two RAM cards installed in the expansion slots, remove the top card and restart.
  - If symptom repeats, replace bottom card with known-good RAM card.
  - If symptom does not repeat, replace top RAM card with known-good RAM card and restart.

For assistance in software troubleshooting, go to Knowledge Base article 106464: Mac OS X: Troubleshooting a Startup Issue.



---

## Flashing question mark appears on the screen

**Note:** This system will only boot the Mac OS X system that shipped with this computer or later. It does not support booting into Mac OS 9.

1. Start up from the software install and restore DVD that came with the computer (hold down the "C" key during restart).
2. When the Installer opens, from the Installer menu, select Open Disk Utility.
3. When the Disk Utility opens, on the left hand side, all disk and volumes are listed. If you don't see the internal hard drive, the system is not recognizing it. Skip to step 4. Otherwise, select the First Aid tab and follow the instructions to verify the hard disk, and repair if needed. Restart the computer.
4. If the hard drive is not recognized, check the hard drive flex cable for damaged connectors (connector peeled off the flex cable, for example), and if bad replace the hard drive flex cable.
5. Reseat the hard drive flex cable. If still not recognized, replace the hard drive.

**Important:** If the computer is under warranty and data recovery is required, refer to Knowledge Base article 31077: DriveSavers: Hard Drive Data Recovery & Warranty Implications, for important information.

6. Reinstall system software using the software install and restore disc.

**Note:** Don't forget to install both the Mac OS X and Applications and Classic software. This operation is completed with two separate installs. Restore disc images are available at <http://service.info.apple.com>. Select "Disc Images."

## Computer begins to power up, the blowers and hard drive are spinning, pressing caps lock key and LED turns on, but there is no startup chime or video

1. Reset the power manager by using the keyboard sequence. Wait five seconds before continuing. Press the power button to start the computer.

**Warning: Resetting the power manager will permanently remove a RAM disk, if present, and all of its contents. You will also need to reset the date and time (using the Date & Time system preferences pane).**

2. Replace the logic board.

---

## System shuts down intermittently

**Important:** This issue can be a result of not using the 65W power adapter with the PowerBook G4 (15-inch FW 800) computers. Confirm with the customer which adapter they were using when having this problem. The adapter can be identified by 65W in the name and markings, and the metal securing-stud on the plug connector.

1. Disconnect all external peripherals and eject any PC card.
2. Make sure a known-good fully charged battery is fully inserted. Check that the battery latch is fully engaged and is not broken or getting caught before fully catching. Check battery connection to logic board.
3. Make a visual inspection of the battery connector in the battery bay. Make sure all blades are visible and not bend. If damaged replace the battery connector.
4. Make sure system is not over heating, the air vents are clear and unit was not used on a soft surface.
5. Check that the blower cables are connected and the blowers are operational.
6. Make sure all feet are still on the system bottom. If not, order foot replacement kit.
7. Check that the thermal material between the heat exchanger and logic board is in contact with both by unscrewing the logic board screws and gently pulling up on the left side of the board to verify resistance caused by adhesion from the thermal material. If not, new thermal materials for the processor, control ASIC, and video chip must be reinstalled (see Logic Board Take Apart chapter).
8. Remove the battery and connect known-good 65W power adapter (661-3048) and power cord or plug to a known-good power outlet; make sure the DC plug is firmly inserted. The DC plug should light up, if not, replace Sound/DC-in board.
9. Verify Sound/DC-in board cable is securely connected and cable shows no signs of wear.
10. Try known-good Sound/DC-in board.
11. Replace the logic board.

## System shuts down almost immediately after startup

1. Disconnect all external peripherals and eject any PC card.
2. Make sure a known-good battery is fully inserted. Check battery charge and make sure that at least two LED charge indicators light, otherwise connect the adapter. The adapter should light amber when plugged in. If not, replace the adapter.
3. After charging for a while, if battery does not seem to charge, or if charged up but quickly discharges, replace the battery. Verify known-good battery.
4. Check battery connection to logic board, and check wire attachment to connectors.
5. If known-good battery does not charge, replace Sound/DC-in board.
6. Replace the logic board.

---

## Application Quits, Kernel panic or other booting problems

1. If a specific application quits, replace the application. Verify the application is compatible with OS X.
2. Clear parameter RAM. Hold down Command-Option-P-R during startup until you hear a second startup chime.
3. Run Disk Utility from the Software Install and Restore DVD.
4. Perform a clean install of system software with the software install and restore disc that came with the computer.

**Note:** Restore disc images are available at <http://service.info.apple.com>. Select “Disc Images.”

5. Reboot system.
6. Run Apple Service Diagnostic in loop mode (Control-L) for an extended time to test the memory. If the test finds bad memory, replace the DIMMs one at a time and test until all bad DIMMs are replaced with known-good modules.
7. Replace the logic board.

## Error Beeps

The computer automatically performs a power-on self test when it is turned on after being fully shut down (not a restart). This section describes what to do if beeps are heard during the startup.

**Note:** The PowerBook G4 (15-inch FW 800) uses PC2700 (also called DDR333) DDR SDRAM SO-DIMMs with a maximum height of 1.25-inch (30 mm). Refer to Memory Card Take Apart chapter for removal and installation.

### Computer beeps once at startup

1. One beep means that no RAM is detected.

**Note:** There is no RAM on the logic board itself, so the computer will beep if no memory is installed in at least one of the RAM slots.

2. Put the original RAM that came with the computer back in, or put in known-good and compatible RAM and restart.
  - If symptom does not repeat, replace RAM card(s).
  - If symptom repeats, replace logic board.

---

### **Computer beeps twice at startup**

1. Two beeps means that EDO memory is installed in the RAM expansion slot. The PowerBook does not accept EDO memory.
2. Replace RAM card(s) with known-good and compatible RAM and restart.
  - If symptom repeats, replace logic board.

### **Computer beeps three times at startup**

1. Three beeps means that no RAM banks passed memory testing.
2. If a RAM card is installed in the upper expansion slot (if not, skip to next step), remove it and restart.
  - If symptom does not repeat, replace RAM card.
  - If symptom repeats, replace RAM in lower RAM slot with known-good and compatible RAM card and restart. If symptom repeats, replace logic board.
3. If a RAM card is not installed in the upper expansion slot, replace RAM in lower RAM slot with known-good and compatible RAM card and restart.
  - If symptom repeats, replace logic board.

### **Computer beeps four times at startup**

1. Four beeps indicates a bad checksum for the remainder of the boot ROM. The ROM (which is located on the logic board) is bad.
2. Replace RAM card(s) with known-good and compatible RAM and restart.
  - If symptom repeats, replace logic board.

Related Knowledge Base articles:

58442: Power On Self-Test Beep Definition - Part 2

95132: PowerBook G4: Installing or Replacing Memory

---

## **AirPort Extreme Card**

### **AirPort Extreme Card not recognized**

1. In Mac OS X, use Software Update in system preferences or see the Apple Software Updates web page to make sure the latest version of AirPort Extreme software is installed.
2. Restart the computer.
3. Open AirPort in system preferences and make sure AirPort is on and Base Station is selected.
4. Check the AirPort Extreme Card flex cable connection to the logic board.
5. Remove and reinstall the AirPort Extreme software.
6. Replace with known-good AirPort Extreme Card.
7. Replace logic board.

### **AirPort connection is slow**

1. Move computer closer to AirPort Base Station or other AirPort device.
2. Too many users are accessing network at the same time causing heavy network traffic. To improve network connection speed, add additional AirPort Base Stations.
3. Check for other changes in the environment that may cause interference with the AirPort signal.
4. Use Software Update in system preferences or see the Apple Software Updates web page to make sure the latest version of AirPort Extreme software is installed.
5. Restart the computer.
6. Check the AirPort Extreme Card flex cable connection to the logic board.
7. Check the connection on both ends of the AirPort Extreme Card antenna jumper cable, if loose, reconnect and test again.
8. Check the AirPort Extreme Card antenna jumper cable for damaged insulation or a crimped cable. If bad, replace antenna jumper cable.
9. Replace with known-good AirPort Extreme Card.
10. Check AirPort Extreme antenna wire coming from display panel for nicked insulator or crimped wire. If bad, replace the diversity board and cable assembly.
11. Replace logic board.

---

## Battery

### Battery will not eject

1. Flip over the unit and turn the battery latch clockwise.
2. If the battery does not pop up, use a small plastic flat-blade tool to pry up the battery around the battery latch.
3. Verify proper latch operation, by exercising the latch. If it does not move smoothly or evenly, replace the bottom case.
4. If the latch does exercise correctly, verify that the customer is not installing the battery with excessive force or the body of the battery has not been deformed around its perimeter.

**Warning: If the battery plastic housing has been damaged, or the two halves of the plastic housing have separated, the battery is unsafe for use.**

5. Try a new battery.
6. Replace bottom case.

### The battery won't charge

1. Remove any externally connected peripherals.
2. Try known-good power outlet.
3. Connect known-good 65W power adapter (661-3048) and power cord or plug; make sure the DC plug is firmly inserted. The DC plug should light up, if not, replace Sound/DC-in board.

If the power adapter light is green, turn over the computer and press the battery button. The battery lights should glow green and stay on if the power adapter is operating correctly.

**Important:** The Apple 65W Power Adapter is highly recommended be used with the PowerBook G4 (15-inch FW 800) computer. The adapters can be identified by 65W in the name and markings, and the metal securing-stud on the plug connector. Although previous 45W power adapters (see Knowledge Base article 88231 PowerBook and iBook: Apple Power Adapter) are plug compatible with the PowerBook G4 (15-inch FW 800), it may not provide sufficient power to operate the system during some activities and may draw power from the battery.

4. Try known-good battery. If it charges, replace the battery. If doesn't charge, check the battery connector and its connection to the logic board.
5. Replace the battery connector assembly (requires removing the logic board).

- 
6. Turn off the computer. Perform the keyboard PMU reset procedure described in the Hardware Troubleshooting Tools and Tips section. Wait five seconds before continuing. Press the power button to start the computer.

**Warning: Resetting the power manager will permanently remove a RAM disk, if present, and all of its contents. You will also need to reset the date and time (using the Date & Time system preference pane).**

7. Make sure the Sound/DC-in cable is firmly connected. Look for damaged insulation or wires.
8. Replace Sound/DC-in power cable.
9. Replace Sound/DC-in board.
10. Replace logic board.

### **Battery life short**

Update battery software. Refer to Knowledge Base article 120281 for a battery software update.

### **Bluetooth**

#### **Bluetooth system preferences does not show up under Hardware system preferences**

1. Check the wire connectors to Sound/DC-in board and the Bluetooth card. Make sure the cable is not damaged and fully inserted.
2. Replace Bluetooth card.
3. Replace the logic board.

#### **Bluetooth Card not recognized by other devices**

1. Open Bluetooth in system preferences and make sure under the Settings tab that Discoverable is checked.
2. Check the Bluetooth antenna is connected to Bluetooth card.
3. Replace with known-good Bluetooth card.
4. Replace the diversity board and cable assembly.
5. Replace logic board.

---

## Display

### Display latch not working

**Note:** When the display is being closed, a latch hook in the top of the display housing should be magnetically pulled down through the slot in the top case and secured by the latch mechanism. When the latch button is pushed, the hook should release and retract into the display housing.

1. See the Latch Adjustment chapter in the Adjustments section of this service manual to verify the latch mechanism and latch hook operation and make adjustments, if necessary.
2. If the latch hook is broken, replace the display latch hook assembly.

### When displaying a single color over the screen area, the LCD panel shows one or more pixels that are not properly lit

To determine whether or not the display has an acceptable number of pixel anomalies, follow the steps below:

1. Set the display image to one of the following colors: all-white display, all-red display, all-green display, or all-blue display. Knowledge Base article 112125: Service Diagnostics Matrix, has the LCD Tester Diagnostic Utility that will generate these patterns on the screen.
2. Using a jeweler's loupe, pocket microscope, or other magnifying device, identify and count each pixel anomaly:
  - Bright subpixel anomaly = subpixel that is always on
  - Dark subpixel anomaly = subpixel that is always off
3. The number of acceptable pixel anomalies for this system is:

#### Acceptable Number of Subpixel Anomalies

Bright	Up to 3
Dark	Up to 5
Combination	Up to 7

4. If the number of subpixel anomalies exceeds the acceptable number listed in the above chart, replace the display panel assembly.

#### Replace

Bright	4 or more
Dark	6 or more
Combination	8 or more



- 
5. If the number of subpixel anomalies is acceptable, explain to the customer that the pixel anomalies are within specifications, and no repair is necessary.

**Important:** Do not release the specifications to customers. Instead, inform them that a certain number of subpixel anomalies are considered acceptable, and these factors apply to all manufacturers using LCD technology—not just Apple products.

When speaking with customers, please use the following explanation:

Active-matrix LCD technology uses rows and columns of addressable locations (pixels) that render text and images on screen. Each pixel location has three separate subpixels (red, green, and blue) that allow the image to be rendered in full color. Each subpixel has a corresponding transistor responsible for turning the subpixel on or off.

There are typically millions of these subpixels on an LCD display. For example, the LCD panel used in the Apple Cinema HD display is made up of 2.3 million pixels and 6.9 million red, green, and blue subpixels. Occasionally, a transistor does not work perfectly, which may result in the affected subpixel being turned on (bright) or turned off (dark). With the millions of subpixels on a display, it is quite possible to have a low number of faulty transistors on an LCD. Therefore, a certain number of subpixel anomalies are considered acceptable. Rejecting all but perfect LCD panels would significantly increase the retail price for products using LCD displays. These factors apply to all manufacturers using LCD technology—not just Apple products.

---

## Hard Drive

### **Internal hard drive will not initialize:**

1. Start up from the software install and restore disc that came with the computer (hold down the "C" key during restart).
2. When the Installer opens, from the Installer menu, select Open Disk Utility.
3. If the hard drive is recognized, format it under the Erase tab.
4. If the hard drive is not recognized, reseal the hard drive flex cable, or replace if needed.
5. If still not recognized, replace the hard drive.
6. Reinstall system software using the software install and restore disc.

**Important:** If the computer is under warranty and data recovery is required, refer to Knowledge Base article 31077: DriveSavers: Hard Drive Data Recovery & Warranty Implications, for important information.

## Keyboard

### **No response from any key on keyboard**

1. Remove any connected peripherals and eject any PC card.
2. Attach an external USB keyboard, if it doesn't work, go to step 7.
3. Turn off the computer. Check the keyboard flex cable connection to the logic board (especially check the connector on the logic board for damage).
4. Start up from the software install and restore disc that came with the computer (hold down the "C" key during restart, if possible) to verify that it is not a software problem.
5. Replace keyboard.
6. Replace logic board.

## No keyboard illumination

1. Go to Keyboard system preference pane and make sure the “Illuminate keyboard in low light conditions” check box is checked. Try using system in a dimly lit environment.

**Note:** The keyboard illumination is not bright enough to be seen in most well lit spaces. In order to view the key being illuminated, the ambient light needs to be dim.

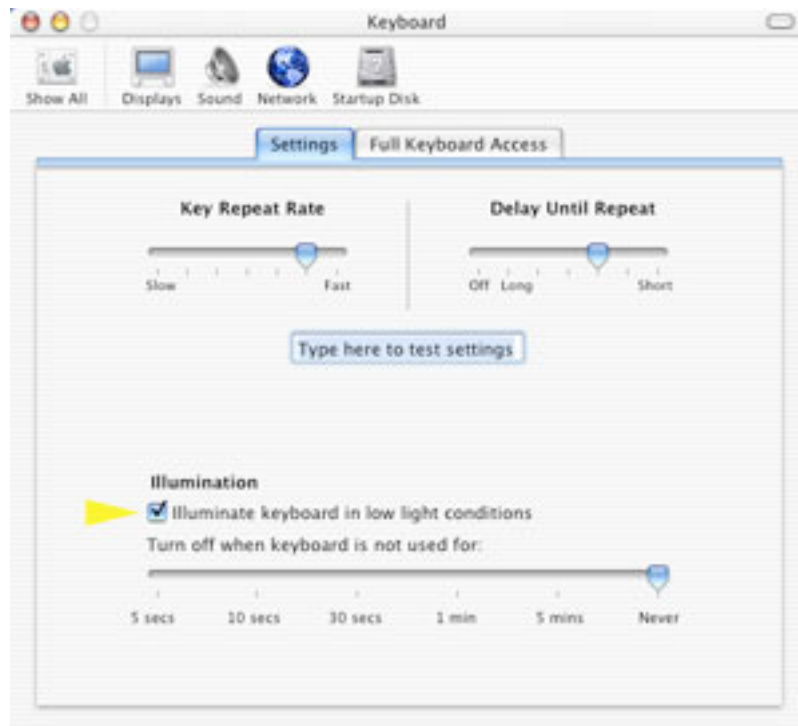

2. Check the keyboard backlight cable connection to the trackpad flex cable, if bad, replace the top case.
3. Replace logic board.

## Half keyboard is illuminated.

Check the keyboard backlight cable connection to the trackpad flex cable and the trackpad flex cable connection to the logic board. If the connections look good, change the top case.

---

## Microphone

### The microphone is not working

1. Check the Sound system preference pane and verify the selection under the Input tab is for the built-in microphone.
2. Check the signal level and level meter and adjust the gain.
3. Reset PRAM (Press the power button, then hold down the Option-Command-P-R keys until you hear the startup chime at least one additional time after the initial startup chime).

**Warning: Resetting the PRAM will permanently remove a RAM disk, if present and all of its contents. You will also need to reset the date and time (using the Date & Time system preference pane).**

4. If there is no sound output from the internal speaker as well as the microphone not working, verify cable connections.
5. Replace the speaker assembly.
6. Replace sound/DC-in board flex cable.
7. Replace the sound/DC-in board.
8. Replace the logic board.

---

## **Modem**

### **No modem dial tone**

1. Check that the correct modem is selected in the Network Port Configuration section of the Network system preferences.
2. Verify known-good analog (not digital) telephone line.
3. Verify known-good RJ-11 telephone cable.
4. Verify RJ-11 cable is not plugged into Ethernet port (should not be physically possible with this PowerBook).
5. Inspect RJ-11 connector for pin damage.
6. Verify RJ-11 telephone cable is firmly installed in the modem port.
7. Open Apple System Profiler, and under the Software tab look at Extensions. Check to see that the MotorolaSM56K and AppleI2SModem Family files are listed and loaded. If not, restart the system and check again. If still not visible replace system software.
8. Open Apple System Profiler, and under the Hardware tab look at Modem. It should show the modem presence by indicating the Modem as Jump. If not visible, start checking modem card connection.
9. Check RJ-11 wires to modem board. Replace the RJ-11 cable assembly, if bad.
10. Check modem flex cable is properly installed between the modem card and main logic board. Replace cable if needed.
11. Replace modem card.
12. Replace logic board.

### **Modem does not respond (can hear dial tone)**

1. Check that the correct modem is selected in the Network Port Configuration section of the Network system preferences.
2. Check modem application is properly configured.
3. Open Apple System Profiler, and under the Software tab look at Extensions. Check to see that the MotorolaSM56K and AppleI2SModem Family files are listed and loaded. If not, restart the system and check again. If still not visible replace system software.
4. Check modem flex cable is properly installed between the modem card and main logic board. Replace cable if needed.
5. Replace modem card.
6. Replace logic board.

---

## **Modem intermittently disconnects or low performance**

1. Verify known-good RJ-11 telephone cable (for example, the retaining clip is not broken off) and it is firmly installed when used. If telephone cable is bad, replace it.
2. Ask if issue happens with only one particular phone line, but not another. The problem may be an issue with that particular phone line. Under bad line condition, try setting the modem script to start with a slower connect rate such as “Apple Internal 56K Modem (v.34).”
3. If the customer indicates the system disconnects under very high CPU loads such as burning DVDs and/or working with video editing software such as Final Cut Pro, try connecting the modem without any application running and see how the modem performs. Use Knowledge Base article 106642: “Mac OS X: Using Apple PPP Test Server” to test the modem. If OK, ask the customer if the task of connecting the modem can be done separately or with less applications running simultaneously.
4. Check RJ-11 wires to modem board. Replace the RJ-11 cable assembly if there is signs of damage.
5. Check modem flex cable is properly installed between the modem card and main logic board. Replace cable if needed.
6. Replace modem card.
7. Replace the logic board.

---

## Optical Drive

### **The optical drive does not accept CD or DVD disc (mechanical failure)**

1. Verify disc is not warped and is a 12 cm circular disc.
2. Check that a small disc is not stuck inside, or other foreign objects. Remove drive from system to extract disc.
3. Verify disc is pushed almost all the way into the slot.
4. Check the optical drive flex cable.
5. Replace optical drive.

### **The optical drive does not eject CD or DVD disc**

1. Verify disc is not in use by quitting any applications that may be using the disc.
2. Press and hold Media Eject key at top right corner of keyboard. If that does not work, hold down Function (fn) key and Media Eject key.
3. Drag disc icon to trash or select it and press Command-E.
4. Choose Restart from Apple menu while holding down trackpad button.
5. Replace optical drive. (See “How to remove a stuck disc from the optical drive” heading of the Optical Drive chapter in the Take Apart section of this manual.)

### **The disc icon does not show up on desktop, or a dialog box appears to initialize disc, when inserting a read-only disc**

1. Verify the correct type of disc is being used.
2. Use Software Update system preference pane to check if there is updated firmware.
3. Try cleaning the disc. If it is dirty or scratched, it may not mount.
4. Try a different disc.
5. Replace optical drive cable.
6. Replace optical drive.

---

## Difficulty writing to optical media

1. Verify the correct type of disc is being used.
2. Try a different brand or speed of CD-R disc.

**Note:** Some brands of 24x or 32x CD-R media may not work with the SuperDrive.

**Note:** There are two factors in the ability for the optical drive to write to media. First, there are varying qualities of blank optical media. Some media are made to such low specifications that the ability for the drive to write to it is marginal.

There are variations in optical media even under the same brand. Some brands source their optical media from a variety of manufacturers, so there may be variations in the quality.

Second, an optical drive that supports writing to a CD-R/RW or DVD-R/RW disc requires a special writing algorithm for discs from different disc manufacturers. There are hundreds of disc manufacturers, it is impossible to implement writing algorithms for each disc manufacturer. Usually, drive manufacturers implement special writing algorithms for discs from major disc manufacturers. For discs that are not supported by the drive with special writing algorithms, the drive will use a generic writing algorithm to write the disc. In this case, the writability and readability may not be optimal.

3. Replace optical drive flex cable.
4. Replace optical drive.



---

## PC Card

### PC Card will not insert into the PC Card slot

1. Make sure the PC Card eject button is in, before attempting to insert a PC Card.
2. Make sure the PC Card is right side up (cards are keyed and cannot be inserted upside down).
3. Verify the PC Card is not warped or damaged in any way; if so replace the card.
4. Try a different PC Card.
5. Carefully raise the PC Card slot cover and check for a foreign object inside the slot.
6. If the slot cover is preventing the card from being inserted, replace the top case.
7. Replace PC Card Cage.

### PC Card does not mount to the desktop

1. Make sure the PC Card has its drivers installed.
2. Check if a known-good PC card works in this slot. The PC card may be bad.
3. Check the PC card cage flex cable connection to the logic board.
4. Replace the PC card cage.
5. Replace the logic board.

## Ports

### A USB port is not recognizing devices

1. Completely shut down, then press the power button to start the computer.
2. Use Software Update system preferences to verify that the latest software is installed.
3. For USB, test ports with an Apple keyboard or mouse. If the left port is not recognized check the Sound/DC-in flex cable's condition and connection. If the right port is not recognized check the backup battery flex cable's condition and connection.
4. If the USB flex cables are fine, replace the Sound/DC-in board for the left USB port or the backup battery board for the right port.
5. Use Apple System Profiler to verify that the computer is recognizing the bus. If not replace the logic board.

---

## **A USB device not recognized by computer**

**Note:** If you are trying to use a serial device with a USB/Serial adapter, check with the manufacturer of the adapter for compatibility.

1. Completely shut down, then press the power button to start the computer.
2. Verify current driver for the device is installed.
3. If a camera, turn on camera after initiating download with camera application.
4. Try the other USB port.
5. Try different USB device on same port.
6. Eliminate chain by plugging in only one peripheral.
7. Try known-good Apple USB keyboard or mouse to verify the port is working properly. If the left port is bad, check the Sound/DC-in board flex cable and connections. If the right port is bad, check the backup battery flex cable and connections.
8. If the USB flex cables are fine, replace the Sound/DC-in board for the left USB port or the backup battery board for the right port.
9. Replace logic board.

## **A FireWire port is not recognizing devices**

1. Test the FireWire 400 and FireWire 800 ports by connecting to another computer using FireWire Target Disk Mode.

Refer to Knowledge Base article 58583: How to Use FireWire Target Disk Mode.

**Important:** When in FireWire Target Disk Mode, use only one FireWire port at a time. Otherwise you risk corrupting the internal hard drive volume.

2. Verify that drivers are installed properly for third party, if needed.
3. Make sure the cables are firmly attached.
4. Try a different cable.
5. If self powered make sure that the power supply is connected and device's LED indicates that it is getting power.
6. Replace logic board.

---

## Sound

### **No sound heard and the Speakers section of the Sound system preference pane indicates that an external device is plugged in (to the headphone jack or USB ports)**

1. If there is nothing plugged into the headphone jack or USB ports, under the Output tab of the Sound system preference pane should be set to the internal speakers.
2. If not, and if nothing is plugged in, try plugging in headphones or external speakers. Restart the computer. Remove the device.
3. Reset PRAM (Press the power button, then hold down the Option-Command-P-R keys until you hear the startup chime at least one additional time after the initial startup chime).

**Warning: Resetting the PRAM will permanently remove a RAM disk, if present, and all of its contents. You will also need to reset the date and time (using the Date & Time system preferences pane).**

4. Check the sound board flex cable to see if the cable is properly seated, the connection is good, and there is no cable damage.
5. Replace sound board.
6. Replace logic board.

### **No sound from speaker(s)**

1. Use the Software Update system preference pane to verify that the latest audio update has been installed.
2. Press the F3 key (with the fn key pressed and not pressed) to verify that mute mode is not enabled.
3. Press the F4 or F5 key (with the fn key pressed and not pressed) to check the volume setting.
4. Verify no external speakers or headphones are plugged in.
5. Check the speakers tab on the Sound control panel to confirm that the software is correctly seeing that there are no external speakers or headphones connected.
6. Shutdown computer and restart.
7. Reset PRAM (Press the power button, then hold down the Option-Command-P-R keys until you hear the startup chime at least one additional time after the initial startup chime).

**Warning: Resetting the PRAM will permanently remove a RAM disk, if present, and all of its contents. You will also need to reset the date and time (using the Date & Time system preference pane).**

8. Verify that the speaker cable is connected properly to sound board.

- 
9. Check speaker cable. Verify left and right cable connections.
  10. Check with headphones or external speaker, if audio is heard, replace speaker assembly.
  11. Replace sound board flex cable.
  12. Replace sound board.
  13. Replace the logic board.

### **Distorted sound from speakers**

1. Verify sound is correct with external speakers/headphones. If sound is correct, check speaker wire and connections.
2. In Sound system preference pane, check balance.
3. Compare same sound with two different units to make sure that sound is actually distorted.
4. Check speaker wire. If damaged, replace speaker assembly.
5. Replace sound board.
6. Replace sound board flex cable.
7. Replace logic board.

---

## Trackpad

### **The cursor does not move when you are using trackpad**

1. Verify that no USB device is connected.
2. Boot from the Software Install and Restore DVD to verify that it is not a software problem.
3. Reset the power manager by pressing the key combination Control-Option-Shift Power.

**Note:** Make sure you do not hold down the “fn” key when resetting the power manager.

4. Check trackpad flex cable connection to the logic board.
5. Replace top case.
6. Replace logic board.

### **The cursor intermittently does not move or moves erratically**

**Note:** User must touch with the surface of only one finger at a time and point directly down on the trackpad surface.

1. Clean trackpad surface (with computer off, using a non-static-inducing material).
2. Completely shut down, then press the power button to start the computer.
3. Reset the power manager by pressing the key combination Control-Option-Shift-power.

**Note:** Make sure you do not hold down the “fn” key when resetting the power manager.

4. Try unit on battery power. If problem goes away, replace power adapter.
5. Place the Software Install and Restore DVD in the optical disc drive, press the start button and hold down the "C" key. Check the cursor movement, to see if the problem is software.
6. Check trackpad flex cable connection to the logic board.
7. Replace top case.
8. Replace logic board.

---

## Video

### **No display, or dim display, but computer appears to operate correctly**

1. Remove any connected peripherals.
2. Make sure F1 key is not stuck down.
3. Press the F2 key (with the fn key pressed and not pressed) to increase the screen brightness settings.
4. Reboot the computer—hold down the Control and Command keys and press the Power button to restart the computer. Or, press and hold the Power button for 5 to 10 seconds to shut down the computer, then press the Power button to restart.
5. **Important:** The Apple 65W Power Adapter is highly recommended be used with the PowerBook G4 (15-inch FW 800) computer. The adapters can be identified by 65W in the name and markings, and the metal securing-stud on the plug connector. Although previous 45W power adapters (see Knowledge Base article 88231 PowerBook and iBook: Apple Power Adapter) are plug compatible with the PowerBook G4 (15-inch FW 800), it may not have sufficient power to operate the system during some activities and may draw power from the battery.
6. Verify inverter cable and LVDS cable connections are seated properly and that the cables are not damaged.
7. Replace inverter board.
8. Replace diversity board and cable assembly.
9. Replace logic board.
10. Replace LCD panel.

### **Computer appears to work, but no video on external device connected to the TV out port (S-video out port)**

1. The device must be connected to the S-video port while the PowerBook is sleeping or off for the device to be recognized.
2. Verify monitor that is used in testing is known-good and is supported by this computer.
3. Try different cable(s).
4. Replace logic board.

### **No video on an external VGA device connected to the external monitor (DVI) port**

1. Verify monitor that is used in testing is known-good and is supported by this computer.
2. Try another DVI-to-VGA adapter cable.
3. Restart the computer and test again.
4. Replace logic board.

---

### **No display, or dim display, but can display external video**

1. Remove any connected peripherals.
2. Open Display system preference panel and check brightness. If works, replace keyboard.
3. Replace inverter board.
4. Replace the diversity board and cable assembly.
5. Replace display panel.
6. Replace logic board.

### **Display has repetitive patterns**

Replace logic board.

### **Display shows shifted color patterns**

1. Replace LVDS cable.
2. Replace logic board.

### **Display has permanent vertical or horizontal lines.**

1. Replace display panel.
2. Replace logic board.

---

## Misc. Symptoms

### The Date and Time settings reset all the time

**Note:** Resetting the power manager or PRAM resets the date and time.

1. Do a backup battery test:
  - Set the date and time.
  - Perform a Shut Down from the Apple menu.
  - Remove the main battery and disconnect the power adapter for 10 minutes.
  - Connect the power adapter, insert the battery, and power on the computer.
  - If the date and time were lost the backup battery may be dead or discharged.
  - Remove the main battery from the unit and leave the PowerBook plugged in for at least 5 hours.

**Note:** If a discharged main battery is installed in the computer, recharging the backup battery may take up to 48 hours to completely charge. It is okay to use it while it is charging.

- If the date and time still reset, replace the backup battery cable.

2. Replace backup battery board.

3. Replace the logic board.

### Feet came off the bottom case

Replace the missing foot.

### Sleep LED does not come on when lid is closed

1. Put the computer to sleep using the menu option. If the sleep LED goes on, there is a problem with sensing the closed display. If the LED does not go on, skip to step 3.
2. With the display housing removed, check the sleep magnet location on the LCD panel: (See the LCD Panel chapter in the Take Apart section of this manual.)
  - If it is not positioned correctly, reposition it.
  - If the magnet is missing, replace it with a new magnet.
3. Check that the sleep LED is plugged into the logic board.
4. Connect a USB mouse. Short the power on pads on the logic board to boot the system and use the mouse to sleep from the menu. Measure the voltage at the LED connector. If power is present, replace bottom case.
5. Replace logic board.



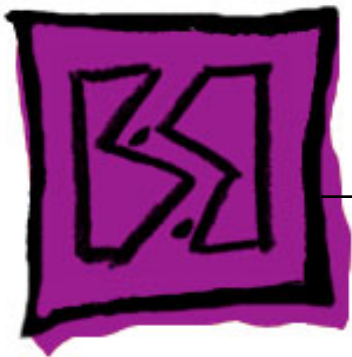

## Views

---

PowerBook G4 (15-inch FW 800)  
PowerBook G4 (15-inch 1.5/1.33GHz)

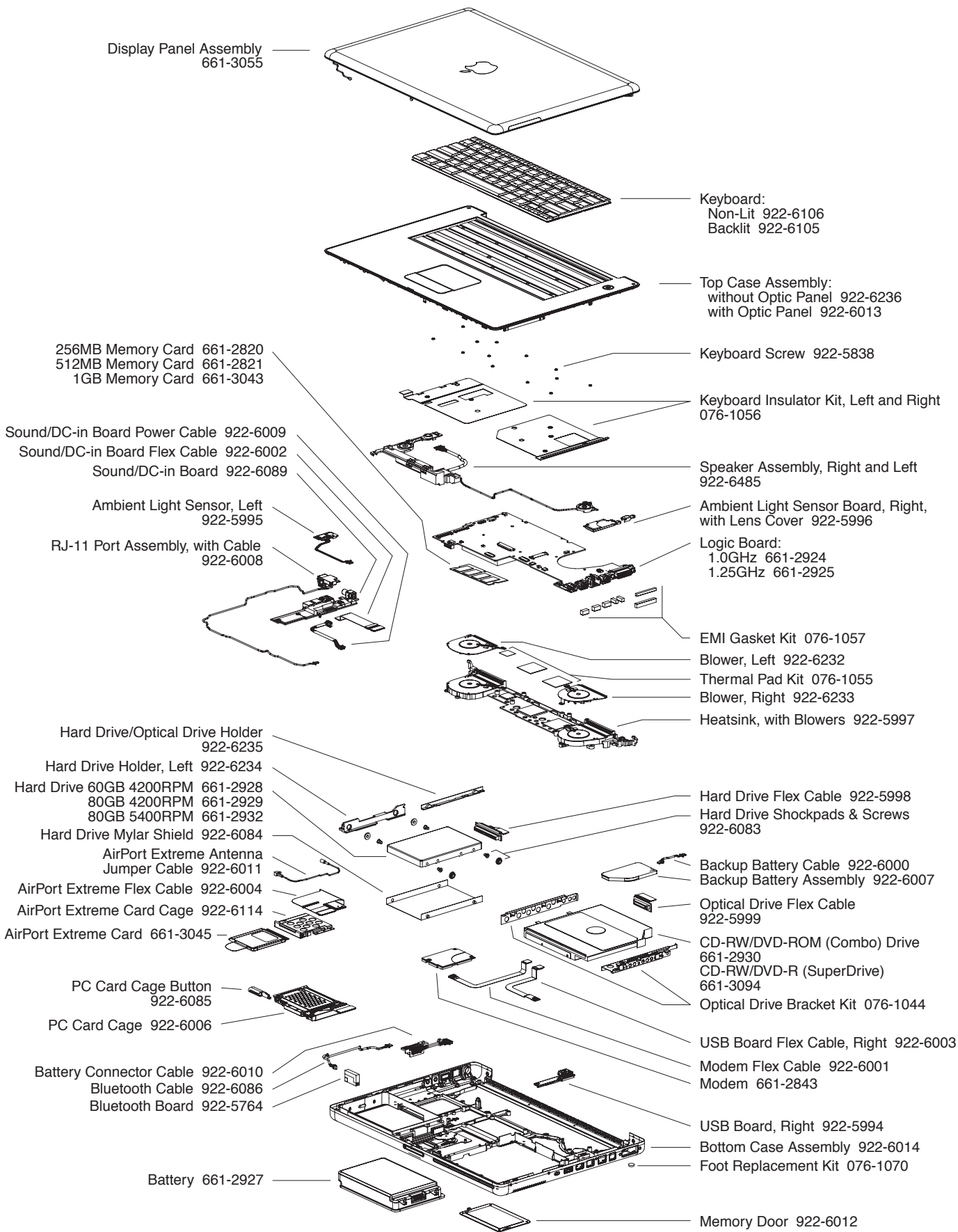

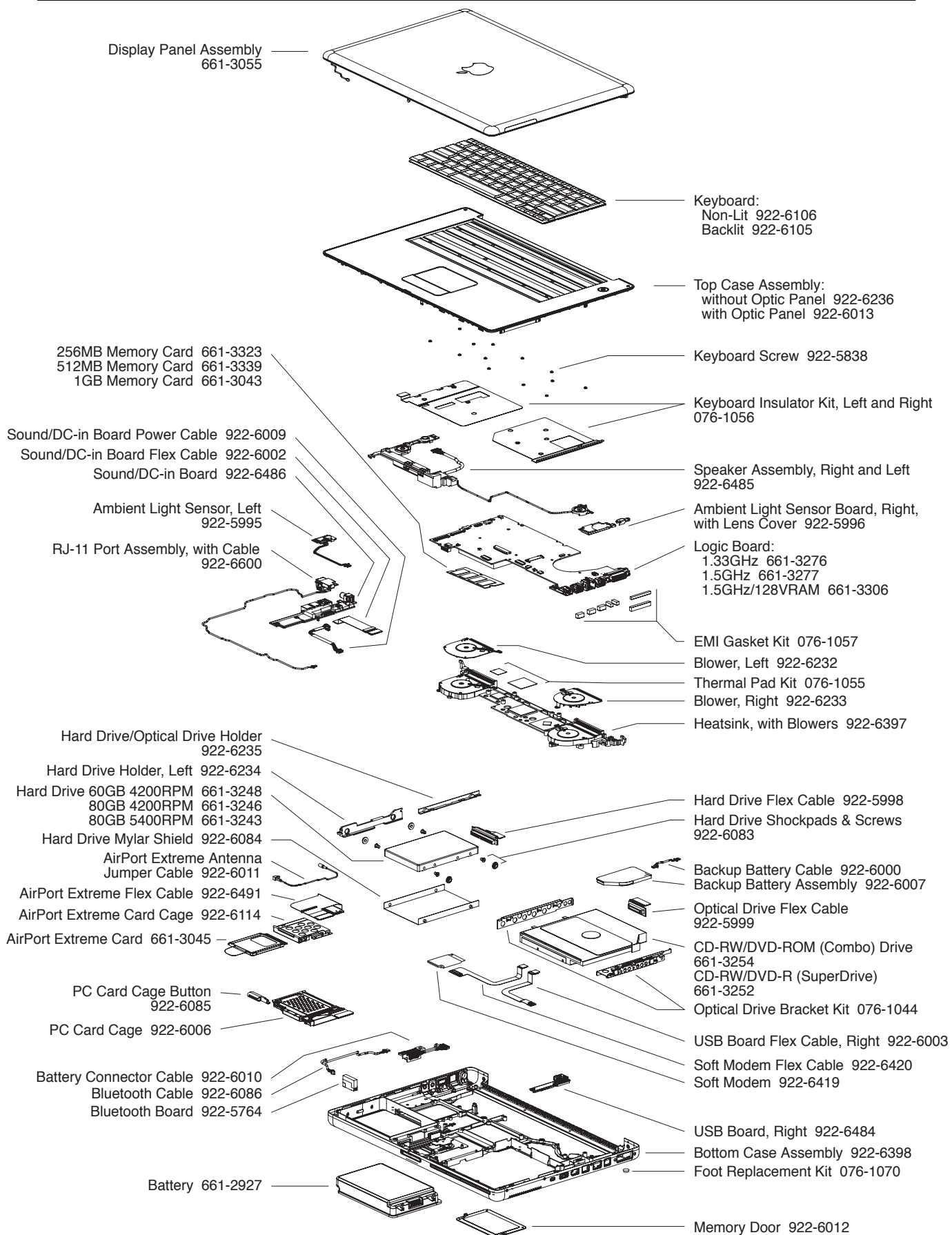

Display Rear Housing, with Logo and Diffuser 922-6018

Logo Diffuser 922-6342

Sleep Magnet 922-6115

LCD Panel 661-2926

Display Bezel 922-6023

Display Latch Hook Assembly 922-6116

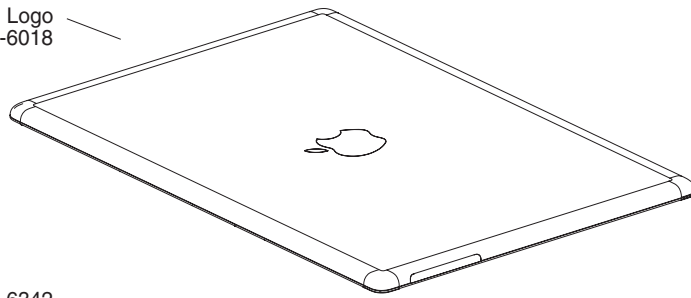

LVDS Cable 922-6016

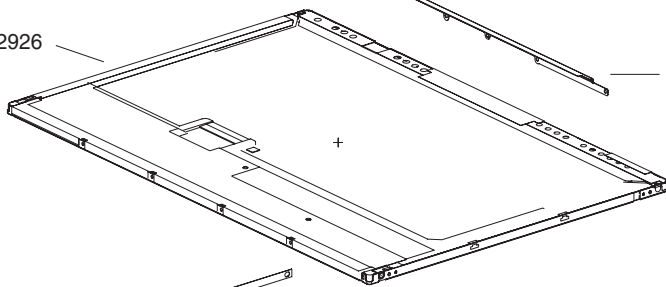

Bezel Holder 922-6019

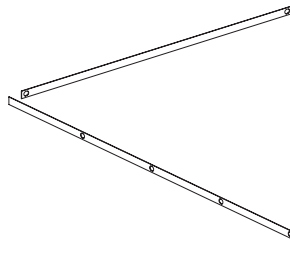

LCD Panel Spacer Kit 076-1069



Clutch, Left 922-6022



Clutch Cap, Left 922-6118

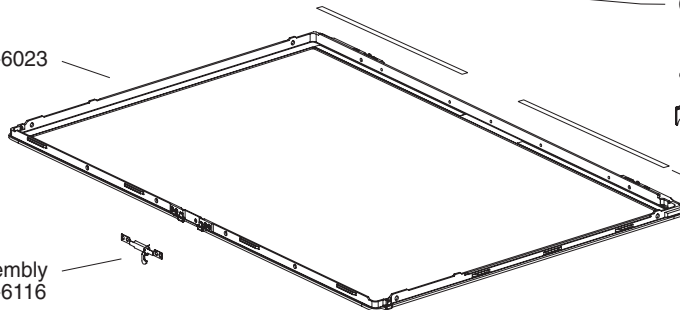

Clutch, Right 922-6021

Clutch Cap, Right 922-6117

Bezel Adhesive Strips 922-6733









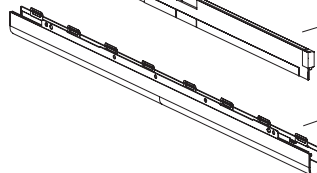
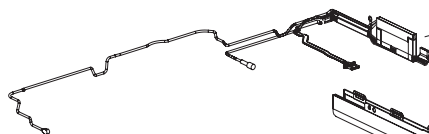





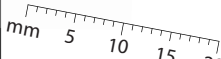











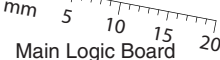







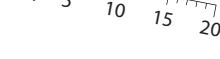

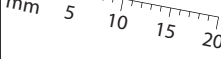

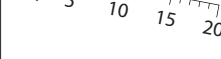

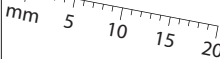

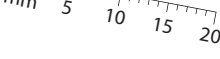

Diversity Board and Cable Assembly 922-6017

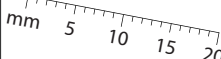
Inverter Board 922-6015

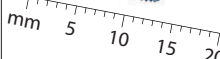
Clutch Cover 922-6020

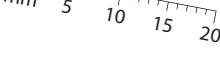

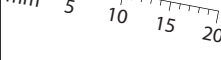
<p><b>922-5840</b> 4 mm Hexnut</p>   <p>Speaker</p>	<p><b>922-5838</b> #0 Phillips, 1.25 mm</p>   <p>Keyboard</p>	<p><b>922-6103</b> #0 Phillips, 2.3 mm</p>   <p>Optical Drive Bracket</p>	<p><b>922-6090</b> #0 Phillips, 3.2 mm</p>   <p>AirPort Chamber ALS Boards Modem Optical Drive, Right Speaker (Left) Bezel to LCD</p>
<p><b>922-6091</b> #0 Phillips, 3.4 mm</p>   <p>Battery Well Bottom Case (Side) RAM Door</p>	<p><b>922-6092</b> #0 Phillips, 3.5 mm</p>   <p>Battery Connector Battery Latch</p>	<p><b>922-6096</b> 1.5 mm Hex, 4.4 mm</p>   <p>Top Case</p>	<p><b>922-6093</b> #0 Phillips, 4.5 mm</p>   <p>PC Card Cage (Left) Blowers Clutch to Bezel Block</p>
<p><b>922-6472</b> #1 Phillips, 4.5 mm</p>   <p>Main Logic Board AirPort Card Flex Right USB Board Heatsink</p>	<p><b>922-6100</b> #0 Phillips, 5.3 mm</p>   <p>Bottom Case (Rear)</p>	<p><b>922-6474</b> #1 Phillips, 5.5 mm</p>   <p>Right Speaker Heatsink</p>	<p><b>922-6083</b> #1 Phillips, 5.8 mm &amp; Stopper</p>    <p>Hard Drive</p>
<p><b>922-6487</b> 1.5 Hex, 6.1 mm</p>   <p>Bezel (Bottom Corners)</p>	<p><b>922-6097</b> #0 Phillips, 6.4 mm</p>   <p>Mass Storage Bracket</p>	<p><b>922-6473</b> #0 Phillips, 6.4 mm</p>   <p>PC Card Cage (Right)</p>	<p><b>922-6473</b> #1 Phillips, 6.9 mm</p>   <p>Logic Board</p>
<p><b>922-6475</b> #1 Phillips, 9.5 mm</p>   <p>Logic Board (Top Right) Heatsink (Top Left)</p>	<p><b>922-6101</b> #0 Phillips, 9.6 mm</p>   <p>Bottom Case (under RAM Door)</p>	<p><b>922-6471</b> T8 Torx, 10.25 mm</p>   <p>Clutch (Rear)</p>	<p><b>922-6098</b> T8 Torx, 13 mm</p>   <p>Clutch (Front) Sound/DC-In Board</p>
<p>5 mm Hexnut Standoff, 14.2 mm</p>   <p>Sound/DC-In Board</p>	<p><b>922-6489</b> #0 Phillips, 16.4 mm</p>   <p>Bottom Case (Bottom)</p>		