

---

# Apple Technician Guide



## Mac mini (Late 2009)

---

Mac mini (Late 2009) and Mac mini Server (Late 2009)

2009-10-27

---

 Apple Inc.

© 2009 Apple Inc. All rights reserved.

Under the copyright laws, this document may not be copied, in whole or in part, without the written consent of Apple.

Every effort has been made to ensure that the information in this document is accurate. Apple is not responsible for printing or clerical errors.

Apple  
1 Infinite Loop  
Cupertino, CA 95014-2084  
USA  
+ 1 408 996 1010  
[www.apple.com](http://www.apple.com)

Apple, the Apple logo, Mac, and Macintosh are trademarks of Apple Inc., registered in the U.S. and other countries.

---

# Mac mini (Late 2009)

## Contents

### Manual Updates 7

Apple Technician Guide introduced 20 October 2009 7

## Basics

### Overview 10

Features Late 2009 Configurations 10  
Product Configurations 10  
System Serial Number Location 11  
Power Supply Serial Number Location 12

## Troubleshooting

### General Troubleshooting 14

Update System Software 14  
Apple Diagnostics 14  
Wireless Troubleshooting 14  
Troubleshooting Theory 14  
Hardware vs. Software 14  
Block Diagram 15  
Common Reset Procedures 16

### Symptom Charts 18

Startup and Power 18  
No Power, Dead Unit 18  
Won't Start Up 20  
Intermittent Shutdown 22  
Kernel Panic, System Crashes 24  
No Video 26  
Corrupted Video 27  
Burnt Smell/Odor 29  
Noise, Hum, Vibration 31  
Uncategorized Symptoms 34  
Communications 35  
AirPort/Bluetooth Issues 35  
AirPort/Bluetooth Card Kernel Panic 38  
Ethernet Port/Device Issue 39  
Wireless Input Device Doesn't Pair 41

---

Wireless Input Device Loses Connection	43
Uncategorized Symptoms	45
Mass Storage	46
Hard Drive Not Recognized	46
Hard Drive Read/Write Error	48
Hard Drive Noisy	49
Uncategorized Symptom- Hard Drive	52
Optical Drive Not Recognized	54
Optical Drive Won't Accept/Eject Media	55
Optical Drive Read/Write Error	57
Optical Drive Not Performing to Specifications	58
Optical Drive Noisy	59
Uncategorized Symptoms	61
Input/Output Devices	62
Apple Remote Inoperable	62
Audio: Built-in Speaker Has Distorted Sound	64
Audio: Built-in Speaker Has No Audio	65
FireWire Devices Not Recognized	67
USB Devices Not Recognized	69
Wired Keyboard Does Not Function Properly	71
Keyboard: Specific Keys Do Not Respond	73
Wired Keyboard/Mouse Not Recognized	73
Uncategorized Symptoms	75
Mechanical	76
Noise/Hum/Vibration	76
System Runs Hot	78
Physical Damage	79
Uncategorized Symptoms	79

## **Take Apart**

### **General Information 81**

General Tools	81
Reassembly Steps	81
Screw Sizes	81
Logic Board EMI Clips	82

### **Top Housing 83**

Removal	84
Reassembly	85

### **Top Housing, Server (Late 2009) 86**

Removal	87
Reassembly	88

### **Internal Frame 89**

---

Removal 90  
Reassembly 93

**Antennas 95**

Removal 96  
Reassembly 98

**Memory 100**

**Audio Board 102**

Removal 103  
Reassembly 105

**AirPort/Bluetooth Combo Card 106**

**IR Board and Cable 108**

**IR Board and Cable (Late 2009) 111**

**Hard Drive Carrier (Late 2009) 114**

**Hard Drive, Lower 116**

**Hard Drive, Upper (Late 2009) 119**

Removal 120  
Reassembly 120

**Optical Drive 121**

**Fan 124**

**Interconnect Board 127**

**Interconnect Board (Late 2009) 129**

**Battery 131**

**Speaker 133**

**Logic Board 136**

Removal 137  
Reassembly 140

**Bottom Housing 141**

**Views**

**Exploded View 143**

**Screw Chart 144**

---

## **Internal Views 145**

Front View 145

Side View 1 145

Side View 2 146

Mac mini w/Optical 146

Mac mini Server w/Dual Hard Drives 147

Port View 148



---

# Manual Updates

## **Apple Technician Guide introduced 20 October 2009**

Take Apart:

New parts specific to the Late 2009 configurations:

- Top Housing, IR Board, Hard Drive Carrier, Hard Drive (Upper), Interconnect Board





---

# **Apple Technician Guide**

## **Basics**

---

### **Mac mini (Late 2009)**

Mac mini (Late 2009) and Mac mini Server (Late 2009)



# Overview



This manual covers two Mac mini products developed in Late 2009:

- Mac mini (Late 2009), shown on left
- Mac mini Server (Late 2009), shown on right

## Features Late 2009 Configurations

- Processor: 2.26GHz Intel Core 2 (Better), 2.53 GHz Intel Core 2 (Best), and 2.53 GHz Intel Core 2 (Server)
- NVIDIA GeForce 9400M graphics
- Memory: 2GB (Better), 4GB (Best), 4GB (Server)
- Hard drives: 160GB (Better), 320GB (Best), dual 500GB SATA (Server)
- Mac OS X Snow Leopard

## Product Configurations

To confirm the configuration from the Apple menu, choose About This Mac. The processor listing will show the speed of the processor followed by the processor type.

For product configurations, refer to Applecare Tech Specs: <http://support.apple.com/specs/>



## System Serial Number Location

The product serial number and Ethernet ID are located on the bottom housing.





## Power Supply Serial Number Location

1. Locate the power supply.



2. Look closely into the opening on the end of the power supply. The serial number is located on the inside cavity of the power supply, where the plug inserts into the power supply.



# Troubleshooting

---

## **Mac mini (Late 2009)**

Mac mini (Late 2009) and Mac mini Server (Late 2009)



# General Troubleshooting



## Update System Software

**Important:** Whenever possible before beginning troubleshooting, ensure the latest software and firmware updates have been applied.

## Apple Diagnostics

Run diagnostics to determine if any of the modules are malfunctioning.

- Mac mini (Late 2009): Apple Diagnostics: 3S133
- Mac mini Server (Late 2009): Apple Server Diagnostics: 3X106
- Apple Hardware Test: 3A150 (all models)

## Wireless Troubleshooting

If you're having issues with AirPort and wireless mouse or keyboard connectivity issues, refer to the following Knowledge Base articles:

- Desktop computers: Troubleshooting wireless mouse and keyboard issues <http://support.apple.com/kb/TS3048>
- AirPort and Bluetooth: Potential sources of interference <http://support.apple.com/kb/HT1365>
- Apple Wireless Keyboard and Mouse: How to install batteries <http://support.apple.com/kb/HT3903>

## Troubleshooting Theory

For general information on troubleshooting theory, refer to:

[http://service.info.apple.com/service\\_training/en/006/troubleshoot/index.php?page=intro](http://service.info.apple.com/service_training/en/006/troubleshoot/index.php?page=intro)

## Hardware vs. Software

For information on how to isolate a hardware issue from a software issue, refer to the following articles:

- Isolating issues in Mac OS X: [http://support.apple.com/kb/TS1388?viewlocale=en\\_US](http://support.apple.com/kb/TS1388?viewlocale=en_US)
- Mac OS X: Troubleshooting installation and software updates: <http://support.apple.com/kb/TS1394>
- Troubleshooting Mac OS X installation from CD or DVD: <http://support.apple.com/kb/HT2956>>

For information on how to troubleshoot a software issue, refer to:

- Mac OS X: How to troubleshoot a software issue: <http://support.apple.com/kb/HT1199>



# Block Diagram

Refer to this diagram to see how modules are interrelated.

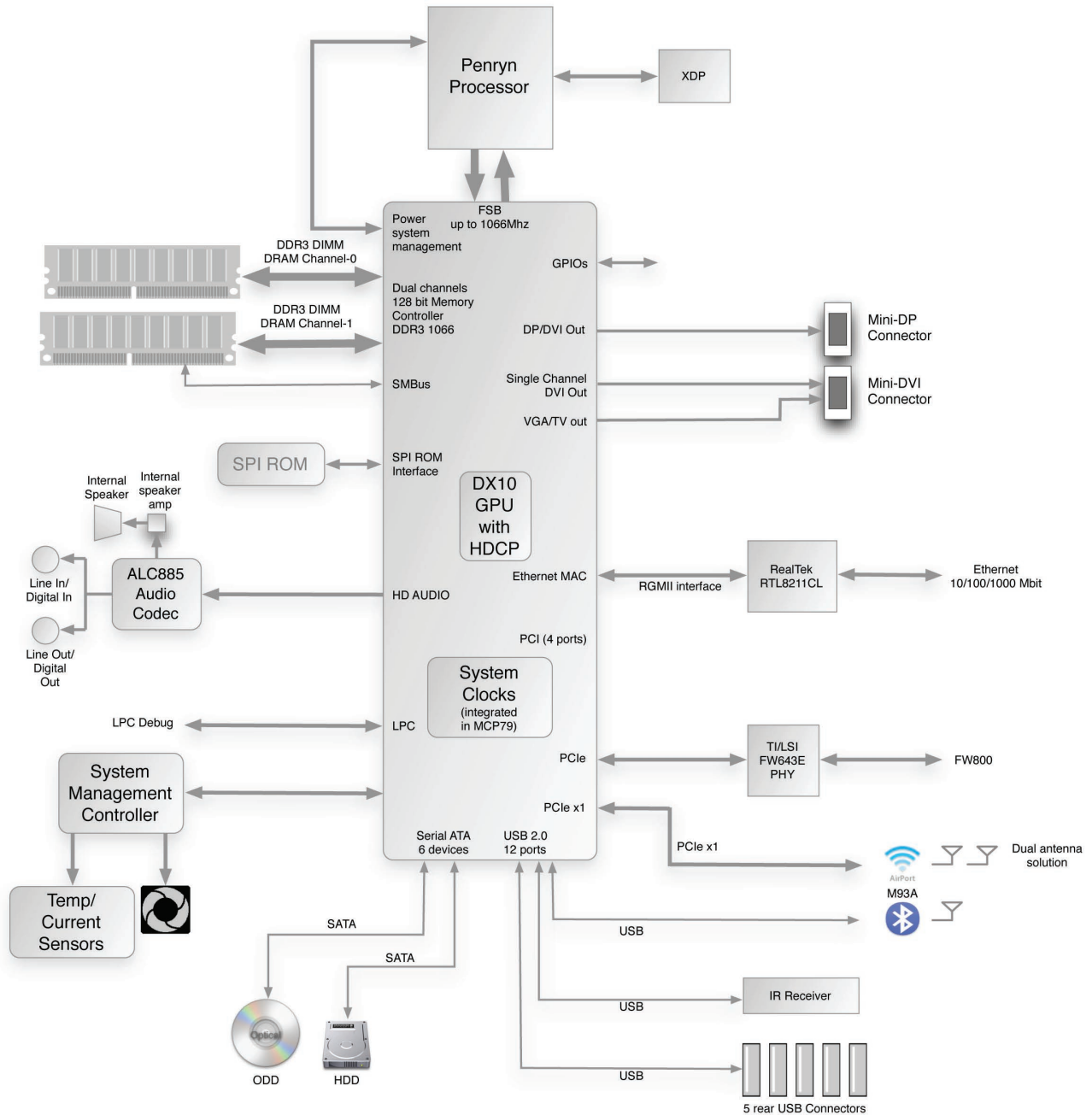



## Common Reset Procedures

When a reset procedure is required for troubleshooting, follow the applicable steps:

### Resetting the System Management Controller (SMC)

To reset power management via the SMC chip:

1. Unplug all cables from computer, including power cord.
2. Wait at least 15 seconds. The SMC reset occurs automatically once the Mac mini has been unplugged from AC power source for several seconds.
3. Plug power cord back in, making sure power button is not being pressed.
4. Reconnect keyboard and mouse to computer.
5. Press power button on back to start up computer.

Resetting the SMC means you will also need to reset the date and time (using the Date & Time pane of System Preferences).

### Resetting the Parameter RAM (PRAM)

To reset PRAM,

1. If the computer is on, turn it off.
2. Locate the following keys on the keyboard: Command, Option, P, and R. You will need to hold these keys down simultaneously in Step 4.

**Note:** If the keyboard does not have an Option key, use the Alt key instead.

3. Turn on the computer.
4. Press and hold the Command-Option-P-R keys.

**Important:** You must press this key combination before the gray screen appears.
5. Hold the keys down until the computer restarts and you hear the startup sound for the second time.
6. Release the keys.





## Starting Up in Safe Mode

A Safe Boot is a special way to start Mac OS X when troubleshooting. To start up into Safe Mode (Safe Boot),

1. Make sure the computer is shut down.
2. Press the power button.
3. Immediately after you hear the startup tone, press and hold the Shift key.  
**Note:** The Shift key should be held as soon as possible after the startup tone but not before.
4. Release the Shift key when you see the screen with the gray Apple and progress indicator (looks like a spinning gear). During startup, "Safe Boot" appears on the Mac OS X startup screen. To leave Safe Mode, restart the computer normally, without holding down any keys during startup.

For more information:

<http://www.apple.com/support>

HT1564—What is Safe Boot, Safe Mode? <<http://support.apple.com/kb/HT1564>>

TS1884—Safe Boot take longer than normal startup <<http://support.apple.com/kb/TS1884>>



# Symptom Charts

Follow the steps in the order indicated below. If an action resolves the issue, retest the system to verify.

**Note:** A compilation of Quick Check tables is available at:

<http://service.info.apple.com/QRS/en/quickreference.pdf>

## Startup and Power

### No Power, Dead Unit

Unlikely cause: speakers

#### Quick Check

Symptoms	Quick Check
<b>No Power, Dead Unit</b> <ul style="list-style-type: none"><li>• No power</li><li>• No LED</li><li>• No fan spin</li><li>• No startup chime</li><li>• No image on external display</li><li>• No hard drive or optical drive activity</li><li>• Caps Lock LED on wired keyboard doesn't light when pressed.</li></ul>	<ol style="list-style-type: none"><li>1. Verify power source.</li><li>2. Verify power cable.</li><li>3. Listen closely for signs of activity from system including: rotating fans, hard drive or optical drive activity, startup chime, etc. If there is activity then go to the 'Startup and Power Issues' symptom flow.</li></ol>



## Deep Dive

Unlikely cause: speakers

Check	Result	Action	Code
1. Power ON system. Verify if there is any indication that the system has powered up (fan rotation, hard drive or optical drive noise, backlight turns on).	Yes	The symptom is powering up. Jump to <a href="#">Won't Start Up symptom flow</a> .	
	No	Go to step 2.	
2. Disconnect AC power from adapter for 1 minute, and reconnect. Does the system power on when power ON button is pressed?.	Yes	It is possible for the power adapter to trip. After problem is identified, determine if the adapter continues to trip. Replace as needed.  Code may be a P01 (if adapter is replaced)	
	No	Go to step 3	
3. Does the unit power on with known good power adapter?	Yes	Bad power adapter, replace and retest.	<b>P01</b>
	No	Go to step 4.	
4. Remove drive internal frame assembly SDRAM, and AirPort/Bluetooth card. Connect power adapter. When the ON button is pressed, does the LED light?	Yes	Go to <a href="#">Won't Start Up symptom flow</a> step 3	<b>P16</b>
	No	Go to step 5.	
5. Inspect power ON button for damage, disconnect power ON cable from logic board, and short pins on connector. Does the front LED power on?	Yes	Bad power switch, replace bottom housing.	<b>X14</b>
	No	Go to step 6	
6. Disconnect LED, remove logic board from bottom housing. Place the logic board on a clean non-metallic surface. Reconnect LED without mounting in housing, Short the power ON pins. Does the LED light?.	Yes	Bottom Housing causing an issue with board, examine for defects or replace.	<b>X13</b>
	No	Replace logic board and retest.	<b>M01</b>



## Won't Start Up

### Quick Check

Symptoms	Quick Check
<p><b>Won't Start Up</b></p> <ul style="list-style-type: none"> <li>No startup chime</li> <li>Error tones during startup.</li> <li>Grey screen with fan noise, or other noise.</li> <li>Will not progress beyond Apple logo or spinning gear.</li> </ul>	<ol style="list-style-type: none"> <li>Isolate OS by starting up from original install media for the computer, the same make and model computer in Target Disk Mode, or compatible known-good OS on an external drive. Both AirPort and Bluetooth services are available when booted from the Install disk.</li> <li>Reset SMC and PRAM to clear any stored, corrupted information.</li> <li>Start up in Safe Mode by holding the shift key down during startup to load only required kernel extensions and disable all startup and login items. See KBase article <a href="http://support.apple.com/kb/HT1564">http://support.apple.com/kb/HT1564</a></li> <li>If system generates error tones there may be an issue with the SDRAM. See KBase article <a href="http://support.apple.com/kb/HT2341">http://support.apple.com/kb/HT2341</a></li> <li>Identifying when in the startup process the computer hangs can help isolate the issue. See KBase article <a href="http://support.apple.com/kb/HT2674">http://support.apple.com/kb/HT2674</a> for information on the Macintosh startup sequence, error codes and symbols used.</li> </ol>

### Deep Dive

Check	Result	Action	Code
1. Boot the computer to Apple Hardware Test on the Install DVD. Does the computer boot up to this volume?	Yes	Run the extended tests and proceed with results. If AHT passes or boots with a memory error, go to step 2.	
	No	Go to step 2.	
2. Remove the installed SDRAM, and test with known-good SDRAM. Does the computer startup properly now?	Yes	SDRAM issue. Replace SDRAM. Issue resolved.	<b>X02</b>
	No	Go to step 3.	



3. Remove the coin battery on the logic board, and leave out for approximately 1 minute. Then reinstall the battery. This will reset the logic board. Does the computer startup properly now?	Yes	Issue resolved by logic board reset. Measure DC voltage on the battery touching the battery with the red probe, and grounding with the black probe. If voltage is 2.7v or less, replace the battery. See KBase article <a href="http://support.apple.com/kb/HT3250">http://support.apple.com/kb/HT3250</a> for details on using a digital multi-meter.	<b>M20</b>
	No	Go to step 4.	
4. Disconnect the drive carrier assembly and power on system. With video only connected to the board, is there a gray screen with a flashing folder?	Yes	Go to Step 5	
	No	Replace logic board..	<b>M02</b>
5. Attempt to boot the system with a known good Firewire boot drive. Does it boot?	Yes	Go to Step 6.	
	No	Replace the logic board.	<b>M02</b>
6. Connect the interconnect board to the logic board. Is there a gray boot screen with a flashing folder?	Yes	Go to step 7	
	No	Replace the interconnect board.	
7. Remove the hard drives (one at a time) from the internal frame assembly, install the internal frame. Does the system boot (other drive may be an optical drive or second hard drive)?	Yes	Go to step 8	
	No	If the optical drive in not recognized, go to <a href="#">Optical Drive not recognized.</a>  If the other hard drive in not recognized, go to <a href="#">Hard Drive Not Recognized</a>	
8. Install hard drive and optical drive into the internal frame assembly, Does the system boot the Install DVD, and see the hard drive?	Yes	Possible connection issue. Retest to verify.	
	No	Go to <a href="#">Hard Drive Not Recognized.</a>	



## Intermittent Shutdown

### Quick Check

Symptoms	Quick Check
<p><b>Intermittent Shutdown</b></p> <ul style="list-style-type: none"> <li>• Powers off during startup.</li> <li>• Powers off during desktop use.</li> <li>• Computer restarts spontaneously.</li> <li>• Powers off when waking from sleep.</li> </ul>	<ol style="list-style-type: none"> <li>1. Isolate OS by starting up from original Install media for the computer, the same make and model computer in Target Disk Mode, or compatible known-good OS on an external drive. Both AirPort and Bluetooth services are available when booted from the Install disk.</li> <li>2. Reset SMC and PRAM to clear any stored, corrupted information.</li> <li>3. Start up in Safe Mode by holding the shift key down during startup to load only required kernel extensions and disable all startup and login items. See KBase article <a href="http://support.apple.com/kb/HT1564">http://support.apple.com/kb/HT1564</a></li> <li>4. Open System Preferences &gt; Energy Saver &gt; Schedule and make sure that a 'Shut Down' event is not scheduled.</li> <li>5. Make sure that power cord is securely attached to the back of the computer, and is not hindered by a desk or other furniture.</li> <li>6. Plug the computer directly into an AC outlet to test whether a surge protector, outlet strip, or UPS is causing the issue.</li> </ol>

### Deep Dive

Check	Result	Action	Code
<p>1. Verify improper shutdown by opening the system.log located in /var/log. Filter the log for "shutdown cause" Entries of value "0" or a negative value indicate an improper shutdown. Did you find entries of improper shutdown?</p>	Yes	Determine if user caused improper shutdown. Use known-good AC power cord and AC outlet. Go to step 2.	
	No	Revisit Quick Check examples for possible software issues. Check if user is running other automating software that may be shutting down system. Verify issue and jump to appropriate symptom flow. No repair needed under current symptom flow.	



2. With known-good AC power cord and AC outlet, does the unit continue to shutdown?	Yes	Go to step 3.	
	No	Replace adapter	<b>P02</b>
3. Disconnect the hard drive power cable from the hard drive and start the machine from the Install DVD, the same make and model computer in Target Disk Mode, or compatible known-good OS on an external drive. Does the computer continue to shutdown? If yes, disconnect the hard drive from the interconnect board, boot the system from a known good DVD or external drive with a known compatible OS.  Does the computer continue to shutdown?	Yes	Go to step 4.	
	No	Possible bad software or hard drive. Go to <a href="#">Hard Drive Not Recognized</a> symptom flow.	
4. Check temperature sensor and run Apple Hardware Test (AHT) or Apple Server Diagnostics. Does it pass?	Yes	Retest. Go to step 1 if problem continues.	
	No	Go to step 5.	
5. Replace or check affected sensor or assembly. Does AHT pass?	Yes	Retest. Go to step 1 if problem continues.	
	No	Logic board issue. Replace logic board.	<b>M08</b>



## Kernel Panic, System Crashes

### Quick Check

Symptoms	Quick Check
<p><b>Kernel Panic, System Crashes</b></p> <ul style="list-style-type: none"> <li>• Kernel Panic on startup or desktop use.</li> <li>• System freeze during use.</li> <li>• System freeze upon wake from sleep.</li> </ul>	<ol style="list-style-type: none"> <li>1. Isolate OS by starting up system from original Install media for the computer, the same make and model computer in Target Disk Mode, or compatible known-good OS on an external drive. Both AirPort and Bluetooth services are available when booted from the Install disk.</li> <li>2. Ensure that all software and firmware updates for the computer have been installed to take advantage of any available bug fixes.</li> <li>3. Reset SMC and PRAM to clear any stored, corrupted information.</li> <li>4. Start up in Safe Mode by holding the shift key down during startup to load only required kernel extensions and disable all startup and login items. See KBase article <a href="http://support.apple.com/kb/HT1564">http://support.apple.com/kb/HT1564</a></li> <li>5. Check the panic.log, located /Library/Logs/Panicreporter, for information in the backtrace that may give clues about the kernel panic.</li> <li>6. For more information on kernel panics refer to KBase article <a href="http://support.apple.com/kb/HT1392">http://support.apple.com/kb/HT1392</a></li> </ol>

### Deep Dive

Check	Result	Action	Code
1. Boot the machine to Apple Hardware Test on the Install DVD, OR, boot Apple Server diagnostics by holding down the "D" key. Does the computer boot up to this volume?	Yes	Run the extended tests and proceed with results. If AHT passes or boots with a kernel panic, go to step 2.	
	No	Go to step 2.	
2. Remove all peripheral devices including the keyboard and mouse. Does computer start without kernel panic?	Yes	Add peripheral devices one at a time until the kernel panic repeats. Replace the device causing the issue.	
	No	Go to step 3.	





3. Use known-good SDRAM in the system. Does the computer start without kernel panic now?	Yes	Install user's SDRAM and test. If kernel panic repeats, replace SDRAM. Verify that the correct SDRAM is being used.	<b>X01</b>
	No	Go to step 4.	
4. Remove AirPort /Bluetooth card and test. Does the computer start without kernel panic now?	Yes	Go to <a href="#">AirPort Card Kernel Panic</a> symptom flow.	
	No	Go to step 5.	
5. Disconnect the Hard Drive from internal frame assembly and startup to the Install DVD on the optical drive, or an external volume. Does the computer start without kernel panic now?	Yes	Go to <a href="#">Hard Drive Not Recognized</a> symptom flow.	
	No	Go to step 6	
6. Disconnect the Audio Board and test. Does the computer start without kernel panic now?	Yes	Replace the Audio Board	<b>X99</b>
	No	Go to step 7.	
7. Disconnect the Optical Drive from the internal frame assembly and test. Does the computer start without kernel panic now?	Yes	Go to <a href="#">Optical Drive not recognized</a> symptom flow	
	No	Replace logic board.	



## No Video

Unlikely cause: hard drive, optical drive, speakers, camera, microphone

### Quick Check

Symptoms	Quick Check
<b>No Video</b> <ul style="list-style-type: none"> <li>No image.</li> </ul>	<ol style="list-style-type: none"> <li>Check display connections</li> <li>Check connections for pin damage.</li> <li>Reset SMC.</li> <li>Go to Deep Dive.</li> </ol>

### Deep Dive: No Video

Check	Result	Action	Code
<b>1.</b> Verify boot chime present and fans running when system powered ON. (Reset SMC and clear PRAM if necessary for proper boot up.)	Yes	Power ON self test OK. Boot sequence started. Go to step 2.	
	No	Go to <a href="#">Won't Start Up symptom flow</a> .	
<b>2.</b> Connect supported external display via mini display port. Verify whether image appears on external display when system is booted.	Yes	Video present. Verify system functionality and return to user or jump to appropriate troubleshooting flow.	
	No	Go to step 3.	
<b>3.</b> Connect supported external display via mini-DVI port. Verify whether image appears on external display when system is booted.	Yes	External display detected by system. Video circuitry on logic board functional. Return to customer or jump to appropriate troubleshooting flow.	
	No	Replace logic board. Retest.	<b>M03</b>



## Corrupted Video

Unlikely cause: Adapter, hard drive, optical drive, fan, or speaker.

### Quick Check

Symptoms	Quick Check
<b>Corrupted Video</b> <ul style="list-style-type: none"> <li>Text and graphics appear fuzzy</li> <li>Image corrupted</li> </ul>	<ol style="list-style-type: none"> <li>Set System Preferences/Display LCD panel to native resolution. Non-native resolutions are unable to produce optimal clarity.</li> <li>Make sure all relevant software updates have been applied. Graphics driver updates may be included with software updates.</li> <li>When the issue occurs take a screenshot of the display (Command-Shift-3). View the screen shot file on another known-good computer. If the image corruption can be seen in the screenshot then the issue is with the video drivers, software, or video/logic board. If the issue cannot be seen in the screenshot then the display and cable should be tested further.</li> <li>Boot from install DVD or another known-good volume to determine whether a potential software/driver issue exists.</li> <li>Go to Deep Dive.</li> </ol>

### Deep Dive

Check	Result	Action	Code
1. Boot from Install DVD and verify whether issue is still visible.	Yes	Go to step 2.	
	No	Issue likely caused by software or driver issue. Troubleshoot for software issues. Make sure all software updates have been installed.	
2. Verify whether issue is visible on an external display attached to the DisplayPort or Mini-DVI. Does the issue appear on "other" display port?	Yes	Issue is isolated to one type of display port. Go to step 3.	
	No	Go to step 5.	



3. Inspect display connector and display cables. Reseat. Does the issue persist?	Yes	Replace Logic board. Go to step 4.	<b>M04</b>
	No	Issue likely caused by poor connection. Return computer to user.	
4. Verify whether issue is still present with replacement logic board installed.	Yes	Go to step 5.	
	No	Issue resolved with replacement logic board installed. Return system to customer.	
5. Test with another similar display with same display connection to determine if issue persists?.	Yes	Replace logic board, may be incompatible with the display. Go to step 4.	<b>M04</b>
	No	Issue resolved with replacement logic board. Return system to customer.	



## Burnt Smell/Odor

Unlikely cause: speakers, microphone, housing

### Quick Check

Symptoms	Quick Check
<b>Burnt Smell/Odor</b> <ul style="list-style-type: none"> <li>Burning smell</li> <li>Unusual odor</li> </ul>	<ol style="list-style-type: none"> <li>Verify source of smell/odor is emanating from the system.</li> <li>Refer to KBase articles: <a href="http://support.apple.com/kb/TA22044">http://support.apple.com/kb/TA22044</a> or <a href="http://support.apple.com/kb/TA22045">http://support.apple.com/kb/TA22045</a>.</li> <li>Disconnect all third party devices and confirm whether the odor is being generated by the device.</li> <li>Inspect air intake and air outlets for obstructions. To prevent overheating make sure there is sufficient clearance to allow air to flow unobstructed into and out of the system.</li> <li>Verify whether system is functional.</li> <li>Go to Deep Dive.</li> </ol>

### Deep Dive

Check	Result	Action	Code
1. Verify whether the source of the odor can be identified by visually inspecting each module and it's associated cables for signs of burned or damaged components, smoke residue, burned traces, or melted or damaged wiring,	Yes	Replace affected module(s). Go to step 2	<b>P08</b>
	No	Unable to locate source of odor. Go to step 3.	
2. Disconnect all 3rd party devices and cables. Power ON system and verify whether smoke or strong odor returns.	Yes	Power down system immediately. Go to step 3.	
	No	System functions correctly. Verify system functionality with 3rd party devices and cables and return system to user if problem has been resolved. Consult 3rd party companies as needed for issues with those products.	



3. Can the source of the odor be located using nose?	Yes	Replace affect module(s) and retest system.	<b>P08</b>
	No	Contact Apple for assistance if you feel that there is a possible safety issue with the computer that has not been resolved in the previous steps.	



## Noise, Hum, Vibration

Unlikely cause: enclosure, cables.

### Quick Check

Symptoms	Quick Check
<b>Noise/Hum/Vibration</b> <ul style="list-style-type: none"><li>• Buzzing noise</li><li>• Rattling noise</li><li>• Ticking noise</li><li>• Squeaking</li></ul>	<ol style="list-style-type: none"><li>1. Verify that the vents on the bottom and back of the system are free of dust and other obstructions that might inhibit proper airflow through the system.</li><li>2. Launch Applications/Utilities/Activity Monitor. Determine whether an application or process is consuming a high percentage of CPU bandwidth. CPU intensive applications can cause the fans to run fast in order to maintain the proper internal system temperatures. If needed, quit the application or restart the system to resolve the issue.</li><li>3. Eject optical media from optical drive. Out of balance optical media can generate audible noise. To resolve try a different brand of media. For additional information jump to 'Optical Drive Noisy' symptom flow. Disconnect all third party devices and confirm whether the odor is being generated by the device.</li><li>4. Play sound sample at loud and soft volume levels to determine if the noise is caused by the speaker or the amplifier circuit. Jump to 'Distorted sound from built-in speakers symptom flow for additional information.</li><li>5. Go to Deep Dive.</li></ol>



## Deep Dive

Check	Result	Action	Code
1. Run Apple Hardware Test or Apple Server Diagnostics. Was an error generated?	Yes	Suspect possible fan or sensor error. Check fan cable connection to the interconnect board.	
	No	Go to step 2.	
2. Does noise sound like fan running faster than expected?	Yes	Reset SMC by disconnecting power cord for ~15 seconds then retest. If issue continues go to step 3.	
	No	Go to step 5.	
3. Does the noise change when the optical drive is being accessed or media is inserted or ejected?	Yes	Suspect issue with optical drive or the media being used. Jump to 'Optical Drive Noisy' symptom flow for additional information.	
	No	Go to step 4.	
4. Mute the system volume. Verify whether the issue still occurs.	Yes	Go to step 5.	
	No	Suspect issue with speaker or audio circuitry. Jump to 'Distorted Sound From Internal Speakers' symptom flow for additional information.	
5. Remove fan and rotate the blades. Verify that fan blades spin smoothly without interference from fan housing.	Yes	Go to step 6.	
	No	Replace fan.	<b>P04</b>





<b>6.</b> Reinstall fan while carefully ensuring that the cable is routed properly and there's no interference with the fan blades. After reassembling system verify that the noise issue is resolved.	Yes	Noise issue resolved. Suspect issue cause by interference from wiring or possible distortion or fan housing when installed in system. Proper reassembly resolved issue.	<b>P04</b>
	No	Go to step 7.	
<b>7.</b> Disconnect these major modules/parts (e.g: hard drive, optical drive, fan) one at a time then power ON the system. Determine if noise issue goes away when one of the modules is disconnected.	Yes	Identify, inspect, and if necessary replace the part that caused the noise to disappear when it was disconnected from the system.	<b>P04</b>
	No	All parts verified. Verify that the correct symptom flow is being used.	



## Uncategorized Symptoms

### Quick Check

Symptoms	Quick Check
<b>Uncategorized Symptoms</b> <ul style="list-style-type: none"> <li>Unable to locate appropriate symptom code.</li> </ul>	<ol style="list-style-type: none"> <li>Make sure system is plugged into a known-good outlet.</li> <li>Listen for boot chime, fan, optical drive, or hard drive noise which indicates system is powering up. If noise is heard, go to <a href="#">Won't Start Up symptom flow</a>. If no noise is heard go to <a href="#">No Power symptom flow</a>.</li> <li>Attempt to boot from Install DVD to isolate possible software issues.</li> </ol>

### Deep Dive

Check	Result	Action	Code
1. Verify whether existing symptom code applies to the issue reported by the user.	Yes	Jump to appropriate symptom code flow.	
	No	Document reported failure and send feedback to <a href="mailto:smfeedback2@apple.com">smfeedback2@apple.com</a> stating that a suitable symptom code wasn't found. Provide as much detail as possible.	<b>N99</b>



# Communications

## AirPort/Bluetooth Issues

**Note:** If one antenna fails, **all** 3 antennas must be replaced because they are paired. Order kit 076-1337.

### Quick Check

Symptoms	Quick Check
<b>AirPort/Bluetooth Issues</b> <ul style="list-style-type: none"><li>• Unable to join networks or pair devices</li><li>• Card not available</li><li>• Intermittent device or connection dropouts</li><li>• Limited wireless range</li></ul>	<ol style="list-style-type: none"><li>1. Verify that AirPort or Bluetooth is turned ON and for AirPort issues make sure that a network is selected.</li><li>2. For AirPort, check if the wireless access point requires special connection and encryption protocols.</li><li>3. Check for nearby sources of interference such as microwave ovens or cordless phones. See article &lt;<a href="http://support.apple.com/kb/HT1365">http://support.apple.com/kb/HT1365</a>&gt;</li><li>4. Check the number of users trying to use AirPort in the area for possible network congestion (available bandwidth).</li><li>5. Isolate potential OS issues by starting up from the original Install media for the computer, the same make and model computer in Target Disk Mode, or compatible known good OS on an external drive. Both AirPort and Bluetooth services are available when booted from the Install disk.</li></ol>



## Deep Dive

Check	Result	Action	Code
1. Open System Profiler. AirPort is listed under Network, while Bluetooth is listed under USB. Is AirPort/Bluetooth recognized?	Yes	Install all software updates for AirPort/Bluetooth. AirPort, go to step 3. Bluetooth, go to step 4	
	No	Remove and reinstall the AirPort/Bluetooth card and retest. Examine the flexible AirPort/Bluetooth cable for damage, and reset. If cable is damaged, go to step 7.  If still unrecognized, replace the AirPort/Bluetooth card. Go to step 2	<b>M11</b>
2. Ensure that Antenna cables are connected properly and not damaged, and all software updates available for AirPort/Bluetooth have been installed. Do connection issues persist?	Yes	AirPort, go to step 3. Bluetooth, go to step 4	
	No	Issue resolved.	
3. Create a computer to computer network with another Macintosh computer using AirPort. See article < <a href="http://docs.info.apple.com/article.html?path=AirPort/5.0/en/ap2110.html">http://docs.info.apple.com/article.html?path=AirPort/5.0/en/ap2110.html</a> >. Can you connect successfully?	Yes	Network or channel issue. Go to step 5	
	No	Double check any password required. Try connecting another known good computer to the network. If test computers connect, replace the AirPort card. Go to step 6	<b>M11</b>
4. Make sure that your Bluetooth device is in discoverable mode, and that your computer is also in discoverable mode. Can you successfully and reliably pair a device now?	Yes	Issue resolved.	
	No	Replace the AirPort/Bluetooth card. Go to step 6	<b>M11</b>
5. Try connecting to a known good network that does not require password or has MAC address filtering enabled. Can you connect to a network reliably now?	Yes	Troubleshoot local network. Possible password or MAC address filtering issue.	
	No	Replace the AirPort/Bluetooth card. Go to step 6	<b>M11</b>



6. With the AirPort/Bluetooth card replaced and antenna cables inspected for damage and replaced if necessary, are the connection issues resolved?	Yes	Issue resolved.	
	No	Replace the logic board	<b>M11</b>
7. Replace the wireless flex cable, and retest. Is Airport/Bluetooth recognized?	Yes	Issue resolved.	
	No	Go to step 2.	



## AirPort/Bluetooth Card Kernel Panic

**Note:** If one antenna fails, **all** 3 antennas must be replaced because they are paired. Order kit 076-1337.

### Quick Check

Symptoms	Quick Check
<b>AirPort/Bluetooth Card Kernel Panic</b> <ul style="list-style-type: none"> <li>Kernel Panic on startup</li> <li>Kernel Panic or freezing while attempting to connect to Wi-Fi networks</li> <li>Kernel Panic while transferring data on Wi-Fi networks</li> </ul>	<ol style="list-style-type: none"> <li>Isolate OS by starting up from original Install media for the computer, the same make and model computer in Target Disk Mode, or compatible known good OS on an external drive. AirPort and Bluetooth services are available when booted from the Install disk.</li> <li>Ensure that all software and firmware updates for the computer and AirPort been installed.</li> </ol>

### Deep Dive

Check	Result	Action	Code
1. Remove AirPort/Bluetooth card. Does computer start without kernel panic?	Yes	Reseat AirPort/Bluetooth card and retest. If problem continues replace AirPort card. Go to step 2	
	No	Possible logic board issue. Go to <a href="#">Kernel Panic/System crashes</a> symptom.	
2. With replacement AirPort/Bluetooth card installed, does computer start without kernel panic?	Yes	AirPort/Bluetooth card issue. Issue resolved.	<b>N13</b>
	No	Possible logic board issue. Go to <a href="#">Kernel Panic/System crashes</a> symptom.	



## Ethernet Port/Device Issue

Unlikely cause: Adapter, hard drive, optical drive, fan

### Quick Check

Symptoms	Quick Check
<b>Ethernet Port/Device Issue</b> <ul style="list-style-type: none"> <li>No Ethernet device present</li> <li>Unable to access network resources</li> <li>Ethernet device shows no connection</li> <li>Ethernet device unable to an IP address</li> <li>Slow network performance</li> </ul>	<ol style="list-style-type: none"> <li>Check the ethernet cable for damage, try a known good Ethernet cable – CAT5 or better recommended for 100Mbps+ connections.</li> <li>Check Ethernet ports on the Mac and wall/switch for dust, debris, damage or bent pins.</li> <li>Ensure distance from networking infrastructure is less than 300 feet/ 105 meters</li> <li>Verify port, cable and network hardware with a known good system. Isolate firewall, MAC address filtering or hardware access control devices</li> <li>Isolate OS by starting up from original Install media for the computer, the same make and model computer in Target Disk Mode, or compatible known good OS on an external drive.</li> </ol>

### Deep Dive

Check	Result	Action	Code
1. Visually inspect the ethernet port of the computer to ensure that all pins will make physical contact with the CAT5 Ethernet cable	Yes	Go to step 2	
	No	Pins are damaged, bent flat or missing. Replace logic board	<b>M24</b>
2. Boot from original Install media. Verify Network Link status active by using Network Utility under the “Info” tab. Is the Link Status “Active”?	Yes	Go to step 3	
	No	If same ethernet cable gives an “Active” link status on a known good computer of same make and model, replace logic board	<b>M10</b>



<p>3. Connect the computer to another Macintosh computer using CAT5 ethernet cable. Mac OS X 10.5 users see article &lt;<a href="http://docs.info.apple.com/article.html?path=Mac/10.5/en/8429.html">http://docs.info.apple.com/article.html?path=Mac/10.5/en/8429.html</a>&gt;.</p> <p>Mac OS X 10.6 users see article &lt;<a href="http://docs.info.apple.com/article.html?path=Mac/10.6/en/8429.html">http://docs.info.apple.com/article.html?path=Mac/10.6/en/8429.html</a>&gt;.</p> <p>Can you connect successfully?</p>	Yes	Ethernet communication good. Go to step 4	
	No	If same ethernet cable and computer connects to a known good computer of same make and model, replace logic board	<b>M10</b>
<p>4. Check for speed and duplex issues on the network. Open System Preference &gt; Network; click the Advanced button, then the Ethernet tab. Is the speed and duplex reported what is expected?</p>	Yes	Go to step 5	
	No	Change the speed and duplex settings. See article < <a href="http://docs.info.apple.com/article.html?path=Mac/10.5/en/8711.html">http://docs.info.apple.com/article.html?path=Mac/10.5/en/8711.html</a> >. Go to step 6	
<p>5. Check for MTU (Maximum Transmission Unit) issues. See article &lt;<a href="http://support.apple.com/kb/HT2532">http://support.apple.com/kb/HT2532</a>&gt;. Does changing the MTU settings on the computer resolve the issue?</p>	Yes	Go to step 6	
	No	Ethernet controller damaged. Replace logic board.	<b>M10</b>
<p>6. If changing the speed, duplex or MTU settings allows connectivity, check with another computer of same make and model. Does the known good computer produce the same results?</p>	Yes	Check with ISP or Network Administrator concerning speed, duplex and MTU settings.	
	No	Verify with known good OS. If the issue persists, replace the logic board.	<b>M10</b>





## Wireless Input Device Doesn't Pair

### Quick Check

Symptoms	Quick Check
<b>Wireless Input Device Doesn't Pair</b> <ul style="list-style-type: none"> <li>Can't get system to recognize the Bluetooth keyboard or mouse</li> </ul>	<ol style="list-style-type: none"> <li>Remove and reinstall the batteries for the device.</li> <li>Check that device is powering on.</li> <li>Use known-good batteries with the device.</li> <li>Ensure that device is being used within range. 30 ft. for Bluetooth devices.</li> <li>Ensure that the latest Software Updates have been applied.</li> </ol>

### Deep Dive

Check	Result	Action	Code
1. Without any wired input devices connected, start the computer. Does the computer show the Bluetooth Mouse Setup assistant?	Yes	Bluetooth hardware is active. Go to step 4	
	No	Inspect and reseat AirPort/Bluetooth flex cable to AirPort/Bluetooth card. Replace a damaged cable. Go to step 2	<b>X03</b>
2. Restart the machine without any wired input devices attached. Does the computer show the Bluetooth Mouse Setup assistant?	Yes	Bluetooth hardware is active. Go to step 4	
	No	Reseat the AirPort/Bluetooth card to the logic board. Go to step 3	
3. Restart the machine without any wired input devices attached. Does the computer show the Bluetooth Mouse Setup assistant?	Yes	Bluetooth hardware is active. Go to step 4	
	No	Replace the AirPort/Bluetooth card.	<b>M11</b>
4. With a wireless mouse on, and in discoverable mode, can you successfully pair the mouse with the assistant?	Yes	Check for stability. Go to step 5	
	No	Go to Wireless Device Loses Connection symptom	



5. With the wireless mouse paired, does the mouse stay connected?	Yes	Issue resolved	
	No	Inspect and reseal the Bluetooth antenna cable. Replace damaged antenna cable or AirPort/Bluetooth card if the antenna connector is damaged. Go to step 6	<b>X03</b>
6. With the wireless mouse paired, does the mouse stay connected?	Yes	Antenna issue. Issue resolved.	
	No	Go to <a href="#">Wireless Device Loses Connection</a> symptom	



## Wireless Input Device Loses Connection

### Quick Check

Symptoms	Quick Check
<p><b>Wireless Input Device Loses Connection</b></p> <ul style="list-style-type: none"> <li>Wireless keyboard, mouse, or other wireless input device loses connection.</li> </ul>	<ol style="list-style-type: none"> <li>Remove and reinstall the batteries for the device.</li> <li>Check that device is powering on.</li> <li>Use known-good batteries with the device.</li> <li>Ensure other devices pair and keep connection without issue. If not, see AirPort/Bluetooth: Defective Wireless Device symptom.</li> <li>Ensure that device is being used within range, 30 feet for Bluetooth devices.</li> <li>Ensure that the latest Software Updates have been applied.</li> </ol>

### Deep Dive

Check	Result	Action	Code
1. Open System Preferences > Bluetooth. Paired items and their connection status are shown. Is the device listed?	Yes	Device has been paired. Go to step 2	
	No	The device is not paired. Make device discoverable and open Bluetooth Setup Assistant. Go to step 3	
2. Make sure device is on. In System Preferences > Bluetooth, select the device and from the Action menu (gear) choose "Connect". Does the device connect successfully?	Yes	Go to step 7	
	No	Delete pairing in System Preferences. Go to step 3	
3. With the device on, run the Bluetooth Setup Assistant. Can you successfully pair the device?	Yes	Go to step 7	
	No	Restart the machine. Go to step 4	
4. With the device on, run the Bluetooth Setup Assistant. Can you successfully pair the device?	Yes	Go to step 7	
	No	Create a new Admin User. Go to step 5	



<b>5.</b> Log into new Admin User account. With the device on, run the Bluetooth Setup Assistant. Can you successfully pair the device with the New User?	Yes	User-based issue. Troubleshoot software on User account. No repair needed.	
	No	Remove the following file: /Library/Preferences/com.apple.Bluetooth.plist Go to step 6	
<b>6.</b> Restart the computer, With the device on, run the Bluetooth Setup Assistant. Can you successfully pair the device?	Yes	Go to step 7	
	No	Go to AirPort/Bluetooth: Defective Wireless Device symptom	
<b>7.</b> With the device paired and connected, is the device connection stable if used normally?	Yes	Issue resolved	
	No	Check device documentation on standard length of operation, and other operational factors. Go to step 8	
<b>8.</b> Is the device performing to stated specifications?	Yes	Educate User. Issue resolved.	
	No	Replace device.	



## Uncategorized Symptoms

### Quick Check

Symptoms	Quick Check
<b>Uncategorized Symptoms</b> <ul style="list-style-type: none"><li>Unable to locate appropriate symptom code.</li></ul>	<ol style="list-style-type: none"><li>Verify System Preferences/Network settings are configured appropriately to support communication method.</li><li>For Ethernet connection issues verify that the cable being used functions when used with another known good system.</li><li>For wireless connection issues review user environment to determine whether possible interference from other 2.4GHz communications devices might be contributing to issue. <a href="http://support.apple.com/kb/HT1365">http://support.apple.com/kb/HT1365</a></li></ol>

### Deep Dive

Check	Result	Action	Code
1. Verify whether existing symptom code applies to the issue reported by the user.	Yes	Jump to appropriate symptom code flow.	
	No	Document reported failure and send feedback to <a href="mailto:smfeedback2@apple.com">smfeedback2@apple.com</a> stating that a suitable symptom code wasn't found. Provide as much detail as possible.	<b>N99</b>



# Mass Storage

## Hard Drive Not Recognized

Unlikely cause: AC adapter, fan, speaker.

### Quick Check

Symptoms	Quick Check
<b>Drive Not Recognized (H01)</b> <b>Drive No Boot (H02)</b> <ul style="list-style-type: none"> <li>Flashing Question Mark</li> <li>Boots to Grey Screen</li> <li>Boots to Blue Screen</li> </ul>	<ol style="list-style-type: none"> <li>Use a known good mouse. A stuck mouse button will not allow boot.</li> <li>Boot from Install DVD or external drive. Verify S.M.A.R.T. status of drive using Disk Utility.</li> <li>Repair disk using Disk Utility.</li> <li>Erase disk and reinstall Mac OS.</li> <li>Use Target Disk Mode to attempt to mount user's hard drive on a known good computer. If mounted, use Disk Utility on host computer for Quick Checks 2, 3 and 4.</li> </ol>

### Deep Dive

Check	Result	Action	Code
1. Boot from Install DVD or external drive and run Disk Utility. Verify that user hard drive is available for Disk Utility to repair.	Yes	Go to step 2	
	No	Go to step 5	
2. Run Disk Utility 'Repair Disk' function and verify that it completes successfully.	Yes	Go to step 3	
	No	Go to step 4	
3. Reboot computer. Verify that system boots successfully and that Disk utility 'Verify' function reports no errors.	Yes	Data error Issue resolved. Return computer to user.	<b>H07</b>
	No	Go to step 4.	
4. Erase disk and reinstall Mac OS using Install DVD or external drive with an installer on it. Verify that installation process completes.	Yes	Go to step 8	
	No	Go to step 5	



5. Inspect hard drive, interconnect board, and connectors for bent pins, or other damage to the cable.	Yes	Replace interconnect board. Go to step 8	<b>H04</b>
	No	Go to step 6	
6. Reseat interconnect board, hard drive and logic board connections and verify whether computer starts up	Yes	Go to step 8	
	No	Replace interconnect board, go to step 8	<b>H04</b>
7. Test with known good hard drive. Verify that system boots successfully and that Disk utility 'Verify' function reports no errors.	Yes	Install user drive, go to step 9	
	No	Interconnect board verified or replaced and known good Hard drive installed, replace logic board.	
8. Reboot computer. Verify that system boots successfully and that Disk utility 'Verify' function reports no errors.	Yes	Issue resolved. Return system to user.	
	No	Go to step 7	
9. Reboot computer. Verify that system boots successfully and that Disk utility 'Verify' function reports no errors.	Yes	Issue resolved	
	No	Hard drive appears to be defective. Go to step 10	
10. Replace hard drive. Does drive format correctly with a GUID partition map and install Mac OS without errors?	Yes	Issue resolved by replacing hard drive.	<b>H05</b>
	No	Interconnect board verified or replaced and known good Hard drive installed, replace logic board..	



## Hard Drive Read/Write Error

Unlikely cause: LCD panel, power supply, fans, speakers, camera, microphone

### Quick Check

Symptoms	Quick Check
<b>Drive Read/Write Error (H03)</b> <b>Drive Bad Sector/Defective (H05)</b> <b>Drive Formatting Issues (H07)</b> <ul style="list-style-type: none"> <li>• Cannot save documents</li> <li>• Read/write error message</li> <li>• Hang when accessing or saving data</li> </ul>	<ol style="list-style-type: none"> <li>1. Boot from Install DVD or external drive. Verify S.M.A.R.T. status of drive using Disk Utility.</li> <li>2. Repair disk using Disk Utility.</li> <li>3. Erase disk and reinstall Mac OS using Install DVD or external drive.</li> <li>4. Use Target Disk Mode to mount user's hard drive on a known good computer. Use Disk Utility on host computer for Quick Checks 1 through 4.</li> </ol>

### Deep Dive

Check	Result	Action	Code
1. Run Disk Utility 'Repair Disk' function and verify that it completes successfully.	Yes	Go to step 2	
	No	Go to step 3	
2. Reboot computer. Verify that system boots successfully and that Disk utility 'Verify' function reports no errors.	Yes	Data error Issue resolved. Return computer to user.	<b>H07</b>
	No	Go to step 3	
3. Erase disk and reinstall Mac OS using Install DVD or external drive. Verify that installation process completes.	Yes	Go to step 7	
	No	Go to step 4	
4. Inspect interconnect board connector for bent pins, or other damage to the board..	Yes	Replace interconnect board. Go to step 7	<b>H04</b>
	No	Go to step 5	
5. Reseat interconnect board, hard drive and logic board connections and verify whether computer starts up	Yes	Go to step 7	
	No	Replace interconnect board, go to step 7	<b>H04</b>





6. Test with known good hard drive. Verify that system boots successfully and that Disk utility 'Verify' function reports no errors.	Yes	Install user drive, go to step 8	
	No	Interconnect board verified or replaced and known good Hard drive installed. Replace logic board.	
7. Reboot computer. Verify that system boots successfully and that Disk utility 'Verify' function reports no errors.	Yes	Issue resolved. Return system to user.	
	No	Go to step 6	
8. Reboot computer. Verify that system boots successfully and that Disk utility 'Verify' function reports no errors.	Yes	Issue resolved	
	No	Hard drive appears to be defective Go to step 9	
9. Replace user hard drive. Does drive format correctly with a GUID partition map and install Mac OS without errors?	Yes	Issue resolved by replacing hard drive.	
	No	Interconnect board verified or replaced and new hard drive installed. Replace logic board.	

## Hard Drive Noisy

Unlikely cause: LCD panel, logic board, power supply, speakers, camera, microphone

### Quick Check

Symptoms	Quick Check
<b>Hard Drive Noisy (H06)</b> <ul style="list-style-type: none"> <li>Noise during start up</li> <li>Noise during operation</li> <li>Noise when drive is copying or saving data</li> </ul>	<ol style="list-style-type: none"> <li>Start up from Install DVD. Verify S.M.A.R.T. status of drive using Disk Utility.</li> <li>Repair disk using Disk Utility.</li> <li>Determine if noise is comparable to another machine of the same model.</li> </ol>



## Deep Dive

Check	Result	Action	Code
1. Boot from Install DVD or external drive and run Disk Utility. Verify that user hard drive is available for Disk Utility to repair.	Yes	Go to step 2	
	No	Go to H01 Drive not recognized/mount	
2. Run Disk Utility 'Repair Disk' function and verify that it completes successfully.	Yes	Go to step 3	
	No	Go to step 4	
3. Re-start the computer. Verify whether the noise is still present.	Yes	Go to step 6	
	No	Data error issue resolved by Disk Utility. Return system to user.	<b>H06</b>
4. Erase disk and reinstall Mac OS using Install DVD or external drive. Verify that installation process completes. Note: Make sure data has been backed up before erasing hard drive.	Yes	Go to step 3	
	No	Replace hard drive. Go to step 5	<b>H06</b>
5. With replacement hard drive installed reboot computer. Verify whether noise is still present.	Yes	Go to step 6	
	No	Issue resolved by replacing hard drive.	
6. Reboot computer. Verify whether noise is still present.	Yes	Replace hard drive. Go to step 7.	
	No	Reseat hard drive into internal frame. Return system to user.	<b>H06</b>
7. With hard drive removed, boot from the Install DVD or external drive and determine if the noise is caused by the fan in the computer.	Yes	Go to M18 fan failures/thermal issues..	
	No	Go to step 8	



8. With hard drive removed and no media in the optical drive, boot from an external volume and determine if the noise is caused by media in the optical drive.	Yes	Go to J04 Optical Drive Noisy.	
	No	Go to step 9.	
9. With replacement hard drive installed verify whether noise level is noticeably quieter than customer's hard drive.	Yes	Customer hard drive noise level is similar to a known good one and does not require repair.	
	No	Replace customer's hard drive. Return system to customer.	<b>H06</b>



## Uncategorized Symptom- Hard Drive

### Quick Check

Symptoms	Quick Check
<b>Uncategorized Symptom</b> <ul style="list-style-type: none"><li>Unable to locate appropriate symptom</li></ul>	<ol style="list-style-type: none"><li>1. Start up the computer holding down the “D” key on the keyboard to see if Apple Hardware Test on the hard drive will boot. If so, run the diagnostic or Apple Server Diagnostics. This will tell you the hard drive is working.</li><li>2. Try starting the system to Apple Hardware Test on the Install DVD or Apple Server Diagnostics. If so, run the diagnostic. This will tell you that the optical drive is working.</li><li>3. Start the computer holding down the Option key on the keyboard. If the Startup Manager is recognizing internal hard drive and optical drive (if Install DVD is in the optical drive) and any external bootable drives connected to the system, SATA connections and external ports are communicating with the logic board.</li><li>4. Remove SDRAM and install Known Good SDRAM and start system. This will verify the SDRAM is not the cause of a startup issue.</li><li>5. Using Disk Utility on Install DVD or external drive to verify SMART status on the hard drive and repair directory structure. This will tell you that the optical drive is working, and will verify your hard drive status and directory.</li><li>6. Boot from another computer of same type in Target Disk Mode, or from an external FireWire drive with compatible Mac OS. This will tell you that your logic board is communicating properly with a compatible Mac OS.</li></ol>



## Deep Dive-Uncategorized Symptoms

Check	Result	Action	Code
1. Verify whether an existing symptom chart applies to the issue reported by the customer.	Yes	Jump to appropriate symptom chart flow.	
	No	Document reported failure symptom and send feedback to <a href="mailto:smfeedback2@apple">smfeedback2@apple</a> stating that a suitable symptom code could not be found.	



## Optical Drive Not Recognized

(For systems with optical drives)

### Quick Check

Symptoms	Quick Check
<b>Drive Not Recognized/Mount (J05)</b> <ul style="list-style-type: none"> <li>Discs inject and eject, but do not appear in Finder</li> </ul>	<ol style="list-style-type: none"> <li>Use Apple System Profiler Serial-ATA section to see if the optical drive appears.</li> <li>Apple System Profiler Serial-ATA section will show any media inserted.</li> <li>Check Finder Preferences and make sure “CD’s, DVD’s and iPods” is checked under “Show these items on the desktop” in the General section.</li> <li>Check both CD and DVD media. If only one type of media is recognized, there is a laser issue. Replace optical drive (J03).</li> </ol>

### Deep Dive

Check	Result	Action	Code
1. Is the optical drive listed in the Serial-ATA section of the Apple System Profiler?	Yes	Go to step 2	
	No	Go to step 3	
2. Test both CD and DVD media. Can drive read both CD media and DVD media?	Yes	Go to step 6	
	No	Drive has a laser issue. Replace the optical drive. If both types media fail, check Finder Preferences then go to step 3	<b>J03</b>
3. Reseat interconnect board at logic board and optical drive. Do both types of media read reliably now?	Yes	Go to step 6	
	No	Go to step 4	
4. Connect known good optical drive to interconnect board. Do both types of media reliably read now?	Yes	Interconnect board and port on logic board good. Go to step 5	
	No	Replace interconnect board and test (X03). If issue persists, replace logic board (M19). Go to step 6	



5. Connect original optical drive to known good interconnect board. Do both types of media reliably read now?	Yes	Interconnect board issue. Replace Interconnect board . Go to step 6	<b>X03</b>
	No	Replace optical drive.	<b>J03</b>
6. Test read compatible known good CD and DVD media (Install DVD). Verify media is recognized and reads reliably.	Yes	Issue resolved.	
	No	Replace optical drive.	<b>J03</b>

## Optical Drive Won't Accept/Eject Media

### Quick Check

Symptoms	Quick Check
<b>Drive Won't Accept Media (J01)</b> <b>Drive Won't Eject Media (J02)</b> <ul style="list-style-type: none"> <li>Cannot insert a disc into the drive</li> <li>Cannot eject a disc placed into the drive</li> </ul>	<ol style="list-style-type: none"> <li>Use Apple System Profiler Serial - ATA section to see if the optical drive appears. If not see Optical Drive not recognized (J05).</li> <li>Restart computer and hold down mouse button or keyboard eject key to cycle optical drive.</li> <li>Inspect optical drive slot for obstructions</li> </ol>

### Deep Dive

Check	Result	Action	Code
1. Verify that optical drive is listed in the System Profiler device tree for Serial-ATA devices.	Yes	Optical drive communicating with logic board. Go to step 5.	
	No	Logic board not communicating with optical drive. Go to step 2	
2. Verify all connection between logic board, interconnect board, and optical drive are secure. Visually inspect connectors for any debris, damage or bent pins. Verify that the optical drive is listed in the System Profiler device tree.	Yes	Go to step 5.	
	No	Replace interconnect board and retest. If connections are good and with no visible board damage, go to step 3	<b>X03</b>



<b>3.</b> Connect known good optical drive to interconnect board. Verify that known good optical drive is listed in the System Profiler device tree.	Yes	Go to step 4.	
	No	Suspect interconnect board. Go to step 7	
<b>4.</b> With known good optical drive installed, test for media inject/eject. Verify drive accepts and ejects known good media.	Yes	Known good optical drive resolved inject/eject issue. Replace optical drive.	<b>J03 (J06)</b>
	No	Go to step 7	
<b>5.</b> Inspect optical drive slot during disc insert/ eject. Verify that discs can be inserted easily.	Yes	Go to step 6	
	No	Replace damaged optical drive..	<b>J03 (J06)</b>
<b>6.</b> With known good optical media (Install disc), test for media inject/eject. Does drive accept and eject known good media?	Yes	Media issue. No repair necessary. Suggest user investigate use of different media.	
	No	Go to step 3	
<b>7.</b> Replace interconnect board with known good optical media (Install disc), test for media inject/eject. Does drive accept and eject known good media?	Yes	Issue resolved. Interconnect board damaged	<b>X03</b>
	No	Interconnect board verified or replaced, and optical drive verified or replaced. Replace logic board and retest.	<b>M19</b>





## Optical Drive Read/Write Error

### Quick Check

Symptoms	Quick Check
<b>Drive Read/Write Data Error (J03)</b> <ul style="list-style-type: none"> <li>Errors when writing optical media.</li> <li>Errors when reading optical media.</li> <li>Hang when accessing or preparing to write data.</li> </ul>	<ol style="list-style-type: none"> <li>Test optical media in another drive of the same type in the same type of computer to rule out media issue.</li> <li>Check with known good discs like the Install discs that came with the computer.</li> <li>For write issues, check with known good media that performs well in another computer optical drive of the same type.</li> <li>Check both CD and DVD media. If only one type of media is producing errors, there is a laser issue. Replace optical drive (J03).</li> </ol>

### Deep Dive

Check	Result	Action	Code
1. Is media free to spin without optical drive scraping edge or surface of media?	Yes	Go to step 2	
	No	Replace optical drive	<b>J05</b>
2. Test both CD and DVD media. Can drive read both CD media and DVD media?	Yes	Go to step 6	
	No	Drive has a laser issue. Replace the optical drive. If both types media fail, go to step 3	<b>J03</b>
3. Reseat interconnect board connections at logic board and optical drive. Do both types of media read reliably now?	Yes	Go to step 6	
	No	Go to step 4	
4. Connect known good optical drive to interconnect board. Do both types of media reliably read now?	Yes	Interconnect board on logic board good. Go to step 5	
	No	Interconnect board connector on logic board is bad. Replace logic board.	<b>M19</b>



5. Connect original optical drive to known good interconnect board. Do both types of media reliably read now?	Yes	Interconnect board issue. Replace interconnect board. Go to step 6	<b>X03</b>
	No	Replace optical drive.	<b>J03</b>
6. Test write data to compatible CD and DVD media. Verify burned media is recognized and reads reliably.	Yes	Issue resolved.	
	No	Replace optical drive.	<b>J03</b>

## Optical Drive Not Performing to Specifications

### Quick Check

Symptoms	Quick Check
<b>Optical Drive Not Performing to Specifications (J07)</b> <ul style="list-style-type: none"> <li>Read or write speeds slower than expected</li> </ul>	<ol style="list-style-type: none"> <li>Test optical media in another drive of the same type in same type of computer to rule out media issue.</li> <li>For Write issues, check with Known Good media that performs well in another computer and drive of the same type.</li> <li>Check both CD and DVD media. If only one type of media is producing errors, you have a laser issue. Replace the optical drive (J05)</li> </ol>

### Deep Dive

Check	Result	Action	Code
1. Test both CD and DVD media. Can drive read both CD media and DVD media?	Yes	Go to step 6	
	No	Drive has a laser issue. Replace the optical drive. If both types media fail, go to step 3	<b>J03</b>
2. Reseat Interconnect board to logic board and optical drive. Do both types of media read reliably now?	Yes	Go to step 6	
	No	Go to step 4	



3. Connect known good optical drive to Interconnect board. Do both types of media reliably read now?	Yes	Interconnect board connections on logic board good. Go to step 5	
	No	Replace Interconnect board and test (X03). If issue persists, replace logic board (M19). Go to step 6	
4. Connect original optical drive to known good interconnect board. Do both types of media reliably read now?	Yes	Interconnect board issue. Replace interconnect board. Go to step 6	<b>X03</b>
	No	Replace optical drive.	<b>J03</b>
5. Test write data to compatible CD and DVD media. Verify burned media is recognized and reads reliably.	Yes	Issue resolved.	
	No	Go to step 7	<b>J03</b>
6. The balance of some media may not perform at higher speeds supported by the drive. Does slowing the requested burn speed allow the discs to write reliably?	Yes	Media issue. No repair necessary.	
	No	Replace optical drive.	<b>J07</b>

## Optical Drive Noisy

### Quick Check

Symptoms	Quick Check
<b>Optical Drive Noisy (J04)</b> <ul style="list-style-type: none"> <li>Noise during boot</li> <li>Noise during operation</li> <li>Noise when drive is copying or writing data</li> </ul>	<ol style="list-style-type: none"> <li>Test optical media in another drive of the same type in same type of machine to rule out media issue.</li> <li>Check with Known Good Discs like the Install disks that came with the computer.</li> <li>Check to see if noise occurs without media in the drive. If so, check hard drive (H06) and fan (M18) caused noise.</li> </ol>



## Deep Dive

Check	Result	Action	Code
1. Optical drive should perform a single reset sequence. Is optical drive constantly seeking or cycling eject mechanism without an optical disc installed??	Yes	Drive mechanism damaged. Replace optical drive.	<b>J05</b>
	No	Go to step 2	
2. Verify media does not exceed maximum thickness specification < <a href="http://support.apple.com/kb/HT2446">http://support.apple.com/kb/HT2446</a> > Using known good CD and DVD media, does media spin without optical drive scraping edge or surface of media?	Yes	Go to step 3	
	No	Drive mechanism damaged. Replace optical drive.	<b>J05</b>
3. Noise when spinning discs before mounting on the desktop and reading data is normal. Disc spin should cease 30 seconds after mounting on the desktop. Is the noise related to disc spin and is it louder than another computer of the same type and drive?	Yes	Go to step 4	
	No	Go to step 5	
4. Remove the optical drive and reseal the drive into it's drive bracket. Reinstall the drive and verify if the drive is still noisy.	Yes	Drive mechanism damaged. Replace optical drive.	<b>J04</b>
	No	Optical drive not mounted correctly. Issue resolved	
5. Noise when ejecting media is normal. Eject known good media and listen to noises. Is the noise related to eject activity and is it louder than another computer of the same type and drive?.	Yes	Drive mechanism damaged. Replace optical drive.	<b>J04</b>
	No	Noise not related to optical drive. Check for hard drive noise (H06) or fan noise (M18)	



## Uncategorized Symptoms

Check	Result	Action	Code
1. Verify whether existing symptom code applies to the issue reported by the user.	Yes	Jump to appropriate symptom code flow.	
	No	Document reported failure and send feedback to <a href="mailto:smfeedback2@apple.com">smfeedback2@apple.com</a> stating that a suitable symptom code wasn't found. Provide as much detail as possible.	<b>N99</b>



# Input/Output Devices

## Apple Remote Inoperable

Unlikely cause: Adapter, fan, optical drive, hard drive

### Quick Check

Symptoms	Quick Check
<p><b>Apple Remote Inoperable</b></p> <ul style="list-style-type: none"> <li>• Apple Remote doesn't bring up Front Row</li> <li>• Apple Remote doesn't control iTunes</li> <li>• Apple Remote doesn't control computer volume</li> </ul>	<ol style="list-style-type: none"> <li>1. Make sure you're using the Apple Remote within 30 ft of the computer, and have an unobstructed line-of-sight to the computer.</li> <li>2. Make sure you're pointing the lens end of the Apple Remote directly at the front of the computer.</li> <li>3. Make sure "Disable remote control infrared receiver" checkbox in the Security</li> <li>4. Test with a known good USB cable when dealing with a printer or external USB drive, to isolate a USB cable issue.</li> <li>5. Ensure that all available Software Updates have been applied to the computer for access to the latest bug fixes.</li> </ol>

### Deep Dive

Check	Result	Action	Code
1. Open System Preferences > Security. Is "Unpair" available in this preference pane?	Yes	Click the "Unpair" button to disable possible pairing with another Apple Remote. Go to step 3	
	No	Possible IR board issue. Go to step 4	
2. With a replacement battery, can you see a white flashing light from the Apple Remote in the video preview window now?	Yes	Battery issue. Issue resolved	<b>X05</b>
	No	Apple Remote defective. Replace the Apple Remote.	<b>X04</b>
3. After clicking "Unpair", does the computer now respond to the Apple Remote?	Yes	Pairing issue. Issue resolved	
	No	Possible IR board issue. Go to step 4	



4. Open the Apple System Profiler. Selecting USB, do you see "IR Receiver" listed?	Yes	IR Receiver reporting on USB bus. Check for lens block. Go to step 5	
	No	Inspect and reseat IR cable to IR board. Replace a damaged IR cable. Go step 6	
5. After clearing lens, does the computer now respond to the Apple Remote?	Yes	Lens blocked. Issue resolved.	
	No	Lens damaged or inoperable. Replace the IR Receiver or top housing.	<b>X13</b>
6. After reseating or replacing the IR cable, does the computer now respond to the Apple Remote?	Yes	IR cable issue. Issue resolved	<b>X03</b>
	No	IR board failure. Replace the IR Receiver.	



## Audio: Built-in Speaker Has Distorted Sound

### Quick Check

Symptoms	Quick Check
<p><b>Audio: Built-in Speakers Have Distorted Sound</b></p> <ul style="list-style-type: none"> <li>No audio from one or both speakers.</li> <li>Audio from speakers distorted</li> </ul>	<ol style="list-style-type: none"> <li>Launch System Preferences and select Sound/Output options. Verify that the sound output option is set to system's internal speakers and that the balance control is set to the center position.</li> <li>Obtain known good high quality sound file or use iTunes music store sound samples to evaluate sound quality. Verify suspect sound files on another system to determine whether the distortion is caused by the system or the sound file.</li> <li>Set volume control to mid-range. Overdriving the built-in speakers can cause distortion.</li> </ol>

### Deep Dive

Check	Result	Action	Code
<p>1. Launch System Preferences and select Sound/Output options. Set speaker balance to the middle, then play a sound file. Verify that sound is generated by the speaker and that the sound quality is acceptable.</p>	Yes	Speaker and amplifier circuitry OK. Go to step 3.	
	No	Distortion detected in speaker. Go to step 2	
<p>2. Connect external speakers or headphones to Headphone Out port then play a sound file. Verify that sound quality is acceptable.</p>	Yes	Suspect bad speaker. Go to step 3.	
	No	Audio CODEC or amplifier issue suspected. Replace audio board. Retest.	<b>M09</b>
<p>3. Inspect speaker cones and speaker connection cable for damage. Does the speaker have visible damage.</p>	Yes	Replace damaged speaker. Retest.	<b>M09</b>
	No	Go to step 4.	





4. Install known good speaker into location where distorted sound was heard. Verify that sound quality improves.	Yes	Speaker bad. Replace speaker and retest.	<b>M09</b>
	No	Suspect speaker amplifier. Replace audio board.	<b>M09</b>

## Audio: Built-in Speaker Has No Audio

### Quick Check

Symptoms	Quick Check
<b>Audio: Built-in Speakers Have No Audio</b> <ul style="list-style-type: none"> <li>No audio from speaker.</li> <li>Audio from speaker distorted</li> </ul>	<ol style="list-style-type: none"> <li>Launch System Preferences and select Sound/ Output options. Verify that the sound output option is set to system's internal speaker.</li> <li>Launch System Preferences and select Sound/ Output options. Verify that the 'Output Volume' setting is set above the minimum level and that the 'mute' option is not selected.</li> <li>Launch System Preferences and select Sound/ Output options. . Verify that 'Balance' is set to middle position</li> <li>Reseat PRAM.</li> <li>Go to Deep Dive..</li> </ol>

### Deep Dive

Check	Result	Action	Code
1. Verify whether boot chime is present when system is powered ON. Note: make sure audio output preferences are not set to mute and volume is set to mid-range.	Yes	Go to step 2	
	No	Audio board not detected by system. Reseat audio board, then retest. Replace audio board if problem persists.	<b>M09</b>
2. Launch System Preferences and select Sound/Output options. Set speaker balance to the middle, then play a sound file. Verify that sound is generated by the speaker and that the sound quality is acceptable..	Yes	Speaker and amplifier circuitry OK. Go to step 3.	
	No	Go to step 6.	



3. Verify whether customer reported audio issue has been resolved.	Yes	Issue no longer present. Return system to customer.	
	No	Go to step 4.	
4. Boot system from Install DVD or another known good bootable volume. Verify whether issue still occurs.	Yes	Go to step 5.	
	No	Known good boot volume works OK. Troubleshoot for software issue. Isolate whether issue is application specific or whether possible operating system conflict. Make sure user data backed up before removing or reinstalling software.	
5. Connect external speakers to Headphone Out port and set System Preferences Sound/Output to external speakers, then play a sound file. Verify that sound quality is acceptable.	Yes	Audio board, internal speaker, and external headphone port functioning correctly. Return system to user.	
	No	Go to step 6	
6. Disconnect and carefully inspect flexible cable and connectors connecting audio board to logic board for damage such as bent pins or pinched/cut wires.	Yes	Replace damaged part(s) then retest. Return to step 1 if problem continues to verify whether symptom has changed.	<b>M09</b>
	No	Replace audio board then retest.	<b>M09</b>



## FireWire Devices Not Recognized

### Quick Check

Symptoms	Quick Check
<b>FireWire Devices Not Recognized</b> <ul style="list-style-type: none"> <li>• FireWire external drive not recognized</li> <li>• FireWire printer not recognized</li> </ul>	<ol style="list-style-type: none"> <li>1. For external FireWire drives, make sure any external power source is plugged in and operating to isolate a power issue with the device.</li> <li>2. Test with a known good FireWire device to isolate a failed peripheral issue.</li> <li>3. Test with a known good FireWire cable to isolate a FireWire cable issue.</li> <li>4. Ensure that all available Software Updates have been applied to the computer for access to the latest bug fixes.</li> </ol>

### Deep Dive

Check	Result	Action	Code
1. Unplug all FireWire devices from the computer. Start the computer and reset PRAM. Reconnect the FireWire device in question. Is the FireWire device recognized?	Yes	Issue resolved	
	No	Possible logic board failure. Go to step 2	
2. Use a known good FireWire cable with a known good FireWire device (another Mac in FireWire Target Disk mode is good). Is this device recognized?	Yes	Try the FireWire device in question with a known good computer of the same make and model. Go to step 3	
	No	FireWire not recognized. Replace main logic board.	<b>M12</b>
3. Is the FireWire device recognized on a known good computer of the same make and model?	Yes	Test the FireWire device with a known good cable on user's computer. Go to step 4	
	No	FireWire device may need additional power. Use a powered FireWire hub. Go to step 5	



<b>4.</b> Is the FireWire device recognized with a known good FireWire cable on the user's computer?	Yes	FireWire cable issue. Issue resolved.	
	No	FireWire device may need additional power. Use a powered FireWire hub. If the issue persists, check for any firmware updates for the FireWire device. Go to step 5	
<b>5.</b> Using a Powered FireWire hub, and having installed any software or firmware update for the device, is the FireWire device recognized now?	Yes	Device recognized. Required additional power from hub or update. Issue resolved.	
	No	Device may require additional software, or there may be a conflict in the Mac OS. Test in New User. Go to step 5	
<b>6.</b> Is the FireWire device recognized with a New User?	Yes	Software Issue. Troubleshoot software on User account. Issue resolved.	
	No	Apply all Mac OS updates. If the issue persists, replace the FireWire device.	



## USB Devices Not Recognized

### Quick Check

Symptoms	Quick Check
<b>USB Devices Not Recognized</b> <ul style="list-style-type: none"> <li>• USB wired keyboard/mouse not recognized</li> <li>• USB external drive not recognized</li> <li>• USB printer not recognized</li> </ul>	<ol style="list-style-type: none"> <li>1. For printers and external USB drives, make sure any external power source is plugged in and operating to isolate a power issue with the device.</li> <li>2. The system has 5 USB ports on the rear of the computer. Make sure to try each port to isolate a particular port malfunction.</li> <li>3. Test with a known good wired keyboard or mouse to isolate a failed peripheral issue.</li> <li>4. Test with a known good USB cable when dealing with a printer or external USB drive, to isolate a USB cable issue.</li> <li>5. Ensure that all available Software Updates have been applied to the computer for access to the latest bug fixes.</li> </ol>

### Deep Dive

Check	Result	Action	Code
1. Unplug all USB devices from the computer except for the keyboard and mouse. Start the computer and reset PRAM. Are the keyboard and mouse recognized?	Yes	Test in all USB ports to ensure all USB ports working as expected. Replace logic board for any port failures.	
	No	Possible logic board failure. Go to step 2	
2. Did Bluetooth Mouse Setup assistant launch after startup?	Yes	Bluetooth detected via Internal USB, but external USB devices not recognized. Go to step 3	
	No	Bluetooth not recognized via internal USB. Disconnect mouse and keyboard. Go to step 4	



3. Are known good mouse and keyboard recognized?	Yes	Test original mouse and keyboard. Replace if still not recognized. Go to step 5	
	No	External USB ports not functioning. Replace logic board.	
4. With no USB devices connected, restart the computer. Did Bluetooth Mouse Setup assistant launch after startup?	Yes	Bluetooth detected via Internal USB. Go to step 3	
	No	Bluetooth not recognized via internal USB. Internal and external USB not functioning. Replace logic board.	<b>M15</b>
5. With known good mouse and keyboard working, test other USB peripheral in question (USB external drive or printer, etc.). Is the device recognized via Apple System Profiler under USB?	Yes	Device recognized. Test in all USB ports to ensure all USB ports working as expected. Replace logic board for any port failures.	
	No	Device may require more power than supplied by USB ports. Try powered USB hub. Go to step 6	
6. Does powered USB hub resolve issue?	Yes	Test device on another computer of the same make and model. If another computer does not require a powered USB hub to allow functionality, replace the logic board	
	No	Test device on another computer of the same make and model. If another computer does not recognize the device, replace the device	



## Wired Keyboard Does Not Function Properly

### Quick Check

Symptoms	Quick Check
<p><b>Wired Keyboard Does Not Function Properly</b></p> <ul style="list-style-type: none"> <li>Some or all keys on the keyboard don't work</li> <li>Eject key or Caps Lock key doesn't seem to work</li> <li>Some keys don't work as expected</li> </ul>	<ol style="list-style-type: none"> <li>The system has 5 USB ports on the rear of the computer. Make sure to try each port to isolate a particular port malfunction.</li> <li>Test with a known good wired keyboard to isolate a failed peripheral issue.</li> <li>Test the keyboard on another Mac. If it works here, you may have bad USB port if the keyboard doesn't work at all, or a software issue if the keyboard is working but not as expected.</li> <li>Ensure that all available Software Updates have been applied to the computer for access to the latest bug fixes.</li> </ol>

### Deep Dive

Check	Result	Action	Code
1. Do any of the keys on the keyboard work?	Yes	Go to step 2	
	No	Go to USB Port Doesn't Recognize Devices symptom	
2. Is the Caps Lock working as expected?	Yes	Go to step 3	
	No	Go to Keyboard: Specific keys do not respond symptom	
3. Is the media Eject key working as expected?	Yes	Go to step 4	
	No	To prevent accidentally ejecting media, Mac OS X adds a slight delay to the Media Eject key before it takes effect. Go to step 5	
4. Open System Preferences > Speech. Is "Speak selected text when the key is pressed" enabled?	Yes	The key combination to speak text cannot be used for any other purpose. Either disable, or change to a more rare key combination (including Shift, Command, Option and Control).	
	No	Go to step 6	<b>M15</b>



5. With optical media in the drive, hold the Media Eject key. Does the disc eject normally and the eject symbol appear?	Yes	Media eject key delay. No repair necessary.	
	No	Go to Optical Drive Won't Accept/Reject Media	
6. Open System Preferences > Universal Access > Keyboard. Is "Slow Keys" enabled?	Yes	With "Slow Keys" on, you need to press a key for a longer period of time for it to be recognized.	
	No	Go to step 7	
7. Open System Preferences > Universal Access > Keyboard. Is "Mouse Keys" enabled?	Yes	With "Mouse Keys" on, you cannot use the Numeric Keypad to enter numbers. It will move the mouse pointer instead.	
	No	Go to step 8	
8. Open System Preferences > International > Input Menu. Check "Keyboard Viewer". Then, from the Input Menu in the Menu Bar (flag), choose "Show Keyboard Viewer". When typing on the keys that are not responding, do they show in the Keyboard Viewer?	Yes	The keys are being recognized. Go to step 9	
	No	The keys are not being recognized. Replace the keyboard.	<b>K01</b>
9. Open TextEdit or another text application and try typing something using the non-responding keys. Do they type in another application?	Yes	Application specific issue. Troubleshoot the application.	
	No	Test another User to isolate a User account issue. If the issue persists, reinstall Mac OS X from the Install DVD.	





## Keyboard: Specific Keys Do Not Respond

### Quick Check

Symptoms	Quick Check
<b>Keyboard: Specific Keys Do Not Respond</b> <ul style="list-style-type: none"><li>• One or more keys do not respond when pressed</li><li>• Key sticks</li><li>• Keycap missing</li></ul>	<ol style="list-style-type: none"><li>1. If wireless keyboard is being used verify that it is properly paired with the system. Go to 'Wireless Input Device Doesn't Pair' symptom flow to resolve pairing issues.</li><li>2. The caps lock key has a built-in delay to reduce accidental activation and must be held for approximately ½ second for it to be activated. Refer to <a href="http://support.apple.com/kb/TS1578">http://support.apple.com/kb/TS1578</a> for additional information.</li><li>3. Inspect the keyboard for signs of liquid spills or other contamination. Apple's warranty does not cover accidental damage.</li><li>4. If the keycap is loose attempt to reattach it.</li><li>5. For other keyboard issues jump to the appropriate symptom flow.</li></ol>

## Wired Keyboard/Mouse Not Recognized

### Quick Check

Symptoms	Quick Check
<b>Wired Keyboard/Mouse Not Recognized</b> <ul style="list-style-type: none"><li>• USB wired keyboard/mouse not recognized when plugged in.</li><li>• Mighty Mouse scroll ball not working or not working as expected.</li><li>• Mighty Mouse buttons not working or not working as expected.</li></ul>	<ol style="list-style-type: none"><li>1. The Mac mini has 5 USB ports on the rear of the computer. Make sure to try each port to isolate a particular port malfunction.</li><li>2. Test with a known good wired keyboard or mouse to isolate a failed peripheral issue. .</li><li>3. Ensure that all available Software Updates have been applied to the computer for access to the latest bug fixes.</li></ol>



## Deep Dive

Check	Result	Action	Code
1. Does the computer recognize the keyboard or mouse when plugged into the USB ports?	Yes	Test in all USB ports to ensure all USB ports working as expected. Replace logic board for any rear port failures. Replace keyboard for any keyboard USB port failures. Go to step 2	
	No	Go to USB Port Doesn't Recognize Devices symptom	
2. Is keyboard working as expected?	Yes	Go to step 3	
	No	Go to Wired Keyboard Does Not Work Properly symptom	
3. Does the Mighty Mouse have an issue with the scroll ball?	Yes	See KBase article < <a href="http://support.apple.com/kb/HT1537">http://support.apple.com/kb/HT1537</a> > for steps to correct	
	No	Go to step 4	
4. Does the Mighty Mouse have an issue with the buttons?	Yes	See KBase article < <a href="http://support.apple.com/kb/HT1581">http://support.apple.com/kb/HT1581</a> > for steps to determine expected behavior. Go to step 7	
	No	Go to step 5	
5. Does the Mighty Mouse have an issue with tracking?	Yes	Try using the mouse on another surface. Non-reflective, opaque surfaces without repetitive patterns work best. The surface should be clean but not shiny. Go to step 6	
	No	Go to step 7	
6. When used on another surface does the mouse track correctly?	Yes	Surface issue. Issue resolved.	
	No	Go to step 7	
7. See KBase article < <a href="http://support.apple.com/kb/HT1581">http://support.apple.com/kb/HT1581</a> > to further determine expected behavior. Did this article resolve the issue?	Yes	Issue resolved.	
	No	Replace the Mighty Mouse	<b>K99</b>



## Uncategorized Symptoms

### Quick Check

Symptoms	Quick Check
<b>Uncategorized Symptoms</b> <ul style="list-style-type: none"><li>Unable to locate appropriate symptom code.</li></ul>	<ol style="list-style-type: none"><li>Verify that external I/O device (where applicable) works on another system.</li><li>For third party I/O devices make sure necessary software is installed and up to date, and that the device is supported with the user's system.</li><li>Go to Deep Dive.</li></ol>

### Deep Dive

Check	Result	Action	Code
1. Verify whether existing symptom code applies to the issue reported by the user.	Yes	Jump to appropriate symptom code flow.	
	No	Document reported failure and send feedback to <a href="mailto:smfeedback2@apple.com">smfeedback2@apple.com</a> stating that a suitable symptom code wasn't found. Provide as much detail as possible.	<b>N99</b>



# Mechanical

## Noise/Hum/Vibration

### Quick Check

Symptoms	Quick Check
<b>Noise/Hum/Vibration</b> <ul style="list-style-type: none"><li>• Buzzing noise</li><li>• Rattling noise</li><li>• Ticking noise</li><li>• Squeaking noise</li></ul>	<ol style="list-style-type: none"><li>1. Verify that the vents on the bottom system are free of dust and other obstructions that might inhibit proper airflow through the system. .</li><li>2. Launch Applications/Utilities/Activity Monitor. Determine whether an application or process is consuming a high percentage of CPU bandwidth. CPU intensive applications can cause the fans to run fast in order to maintain the proper internal system temperatures. If needed, quit the application or restart the system to resolve the issue.</li><li>3. Play sound sample at loud and soft volume levels to determine if the noise is caused by the speaker or the amplifier circuit. Jump to 'Distorted sound from built-in speaker' symptom flow for additional information.</li></ol>



## Deep Dive

Check	Result	Action	Code
1. Run Apple Hardware Test or Apple Server Diagnostics. Was an error generated?	Yes	Check fan connection to interconnect board and retest.	
	No	Go to step 2.	
2. Does noise sound like fan is running faster than expected?	Yes	Reset SMC by disconnecting power cord for ~15 seconds then retest. If issue continues go to step 3.	
	No	Go to step 5.	
3. Does the noise change when the optical drive is being accessed or media is inserted or ejected?	Yes	Suspect issue with optical drive or the media being used. Jump to 'Optical Drive Noisy symptom flow for additional information.	
	No	Go to step 4.	
4. Mute the system volume. Verify whether the issue still occurs.	Yes	Go to step 5.	
	No	Suspect issue with speaker or audio amplifier circuitry. Go to 'Distorted Sound From Internal Speakers' symptom flow for additional information.	
5. Open unit. Remove fan and rotate the blades. Verify that fan blades spin smoothly without interference from fan housing.	Yes	Fan reseated, blades rotate, noise gone.	
	No	Replace affected fan.	<b>P04</b>



## System Runs Hot

### Quick Check

Symptoms	Quick Check
<b>System Runs Hot</b> <ul style="list-style-type: none"> <li>• System feels very hot</li> <li>• Fan not operating</li> <li>• Fan running fast</li> <li>• System is noisy</li> </ul>	<ol style="list-style-type: none"> <li>1. Verify that the vents on the bottom are free of dust and other obstructions that might inhibit proper airflow through the system.</li> <li>2. Verify that the computer is not exposed to direct sunlight which may heat up the enclosure making it feel hot to the touch.</li> <li>3. Verify the computer is not running hotter than expected for normal operation.</li> <li>4. Launch Applications/Utilities/Activity Monitor. Determine whether an application or process is consuming a high percentage of CPU bandwidth. CPU intensive applications can cause the fans to run fast in order to maintain the proper internal system temperatures. If needed, quit the application or restart the system to resolve the issue.</li> <li>5. Reset SMC by unplugging power cord for ~15 seconds.</li> </ol>

### Deep Dive

Check	Result	Action	Code
1. Run Apple Hardware Test or Apple Server Diagnostics. Was an error generated?	Yes	Suspect possible fan or sensor error. . Check fan cable connection to the interconnect board.	
	No	Go to step 2.	
2. Does noise sound like one or more fans running faster than expected?	Yes	Fan running fast. Reset SMC by disconnecting power cord for ~15 seconds then retest. If issue continues go to step 3.	
	No	Go to step 3.	



3. Remove fan and rotate the blades. Verify that fan blades spin smoothly without interference from fan housing and that the fan blades are all intact.	Yes	Fan reseated, blades rotate, noise gone.	
	No	Replace affected fan.	P06

## Physical Damage

### Quick Check

Symptoms	Quick Check
<b>Physical Damage</b> <ul style="list-style-type: none"> <li>Stripped screw/head</li> <li>Stripped screw boss</li> <li>Dent or scratch to chassis</li> </ul>	<b>1.</b> Determine whether damage caused by user environment, accidental damage, or abuse. If applicable inform the user that Apple does not warrant damage caused by accident, abuse, misuse, flood, fire, earthquake, or other external causes. For more information refer to: <a href="http://www.apple.com/legal/warranty">http://www.apple.com/legal/warranty</a>

## Uncategorized Symptoms

Check	Result	Action	Code
1. Verify whether existing symptom code applies to the issue reported by the user.	Yes	Jump to appropriate symptom code flow.	
	No	Document reported failure and send feedback to <a href="mailto:smfeedback2@apple.com">smfeedback2@apple.com</a> stating that a suitable symptom code wasn't found. Provide as much detail as possible.	N99

## **Take Apart**

---

### **Mac mini (Late 2009)**

Mac mini (Late 2009) and Mac mini Server (Late 2009)





# General Information

## General Tools

The following tools are required to service the computer:

- ESD wriststrap and mat
- Tweezers
- Jeweler's #0 Phillips screwdriver
- Jeweler's #1 Phillips screwdriver
- Phillips #2 screwdriver
- Black stick (922-5065), or other nonconductive nylon or plastic tool
- Needlenose pliers
- Soft cloth (to protect removed parts from scratches)
- Screw tray
- Putty knife (922-6761), 1.5 inch (38 mm) to open the top case



Refer to the following Apple Knowledge Base article to purchase tools:

[kBase #500200: Hand Tools for Desktop and Portable Repairs](#)

## Reassembly Steps

When there are no replacement steps listed, replace parts in the exact reverse order of the Removal procedure.

## Screw Sizes

All screw sizes shown are approximate and represent the total length of the screw.



## Logic Board EMI Clips

- 1 Be careful not to damage the EMI clips on the underside of the logic board. Place the board on the antistatic foam when the board is not in a system.
- 2 **Important:** Return the logic board to Apple service in the correct logic board packaging and with the antistatic foam protecting the EMI clips (shown in second photo).

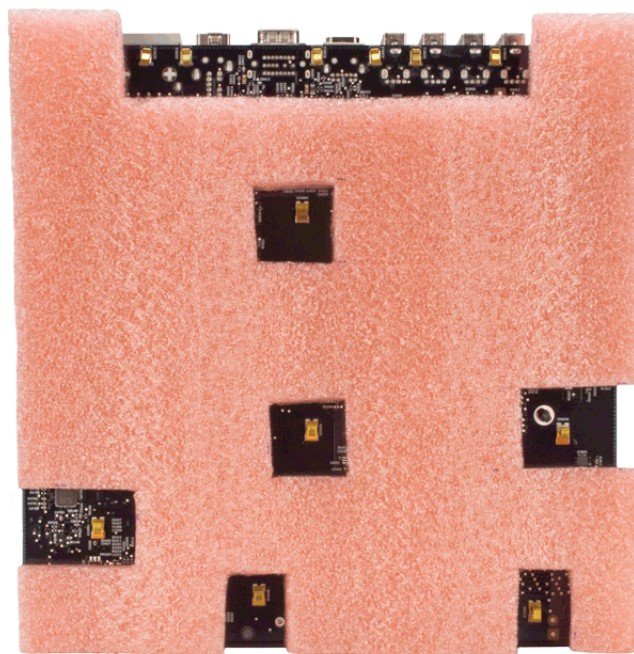
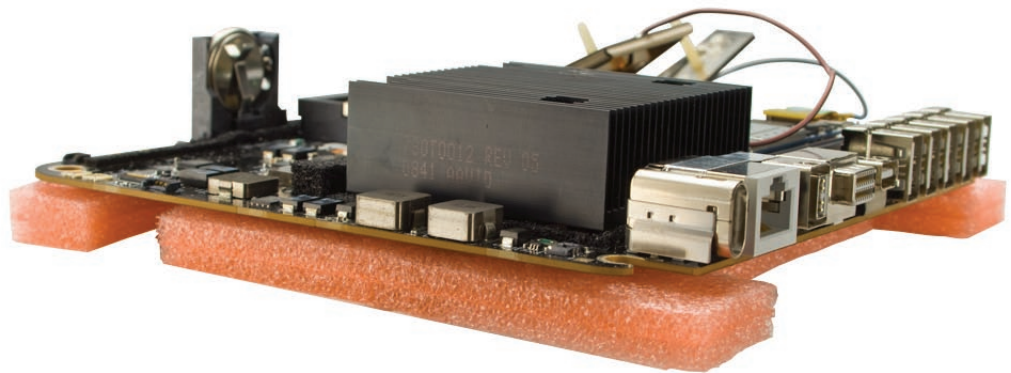



# Top Housing

## First Steps

- Shut down the computer.
- Place the computer on a clean, flat surface.



## Tools

- Putty knife (922-6761)
- ESD mat and wrist strap





## Removal

- 1 Turn the computer over.
- 2 Insert the tool (0.25 inch / 6.35 millimeters) into the gap.
- 3 Pry the tool away from the computer.  
**Note:** You will hear little cracking sounds as the latches release and the bottom separates from the top housing



- 4 Repeat on other side.

- 5 Using your fingers, push the I/O panel upward. The cracking sounds will continue as you push the I/O panel off the top housing; this is normal.

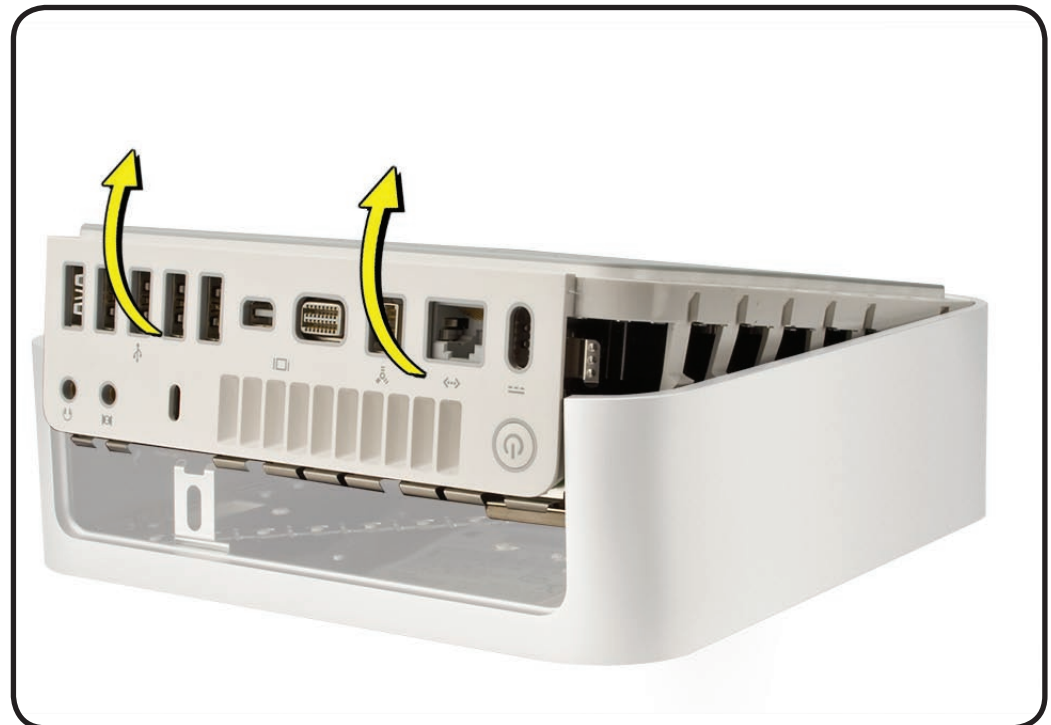



## Reassembly

- 1 Align rear I/O panel with top housing.
- 2 Make sure the white latches are tucked inside bottom housing as you press the top and bottom together.



- 3 Squeeze until there are no visible gaps.

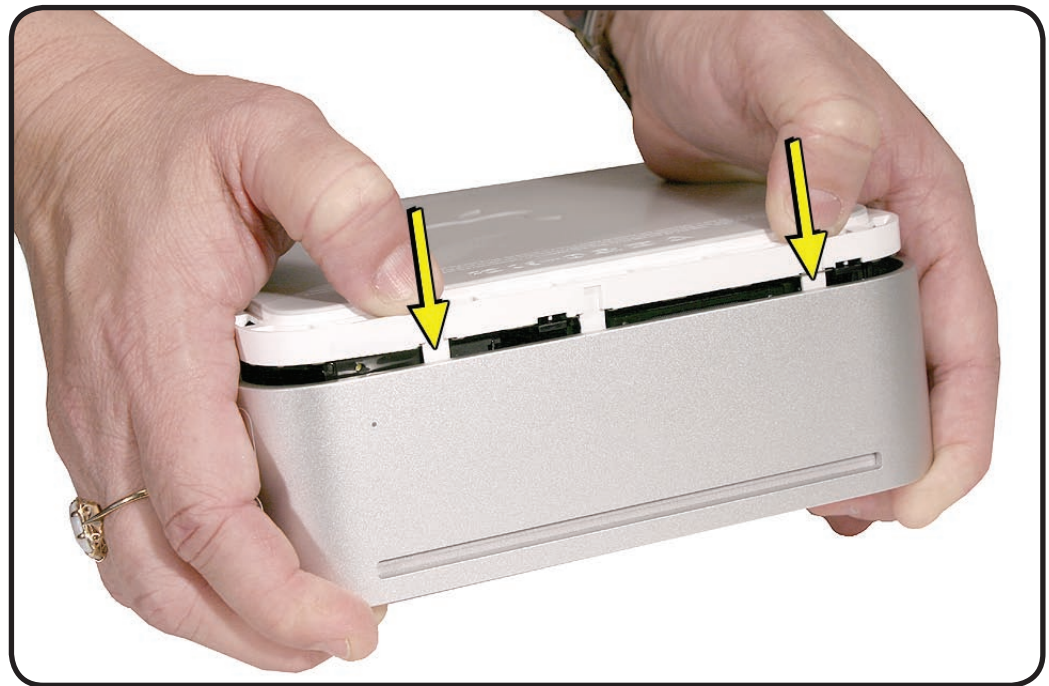



# Top Housing, Server (Late 2009)

## First Steps

- Shut down the computer.
- Place the computer on a clean, flat surface.

**Note:** This optical-less top housing is for the dual hard drive server configuration only.



## Tools

- Putty knife (922-6761)
- ESD mat and wrist strap





## Removal

- 1 Turn the computer over.
- 2 Insert the tool (0.25 inch / 6.35 millimeters) into the gap.
- 3 Pry the tool away from the computer.  
**Note:** You will hear little cracking sounds as the latches release and the bottom separates from the top housing



- 4 Repeat on other side.

- 5 Using your fingers, push the I/O panel upward. The cracking sounds will continue as you push the I/O panel off the top housing; this is normal.

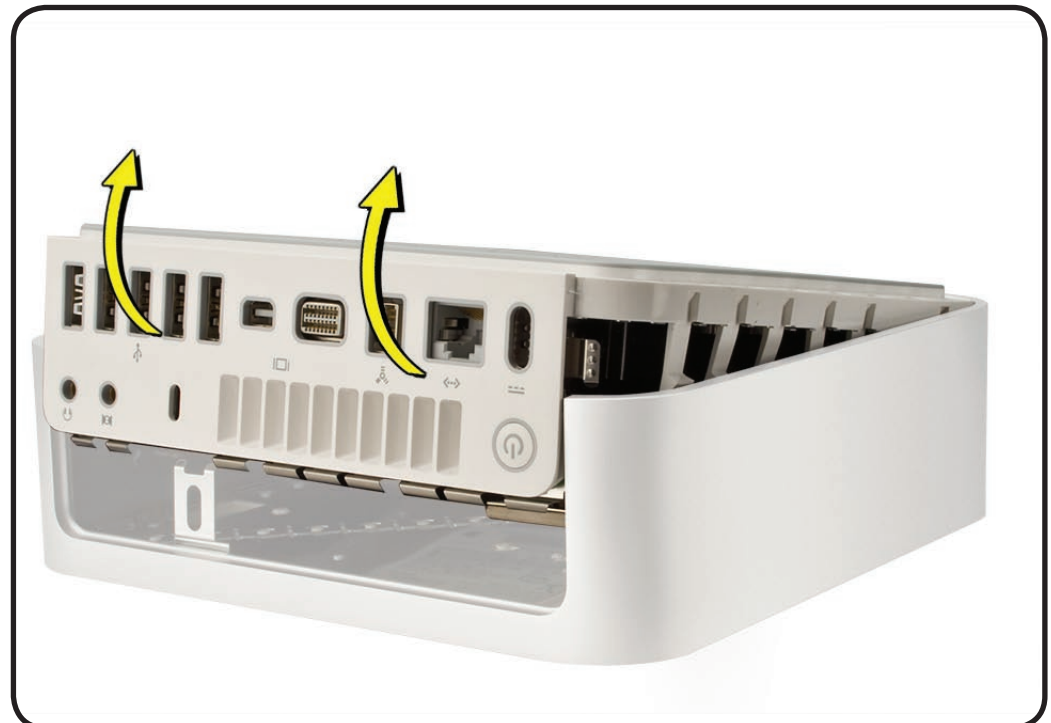



## Reassembly

- 1 Align rear I/O panel with top housing.
- 2 Make sure the white latches are tucked inside bottom housing as you press the top and bottom together.



- 3 Squeeze until there are no visible gaps.

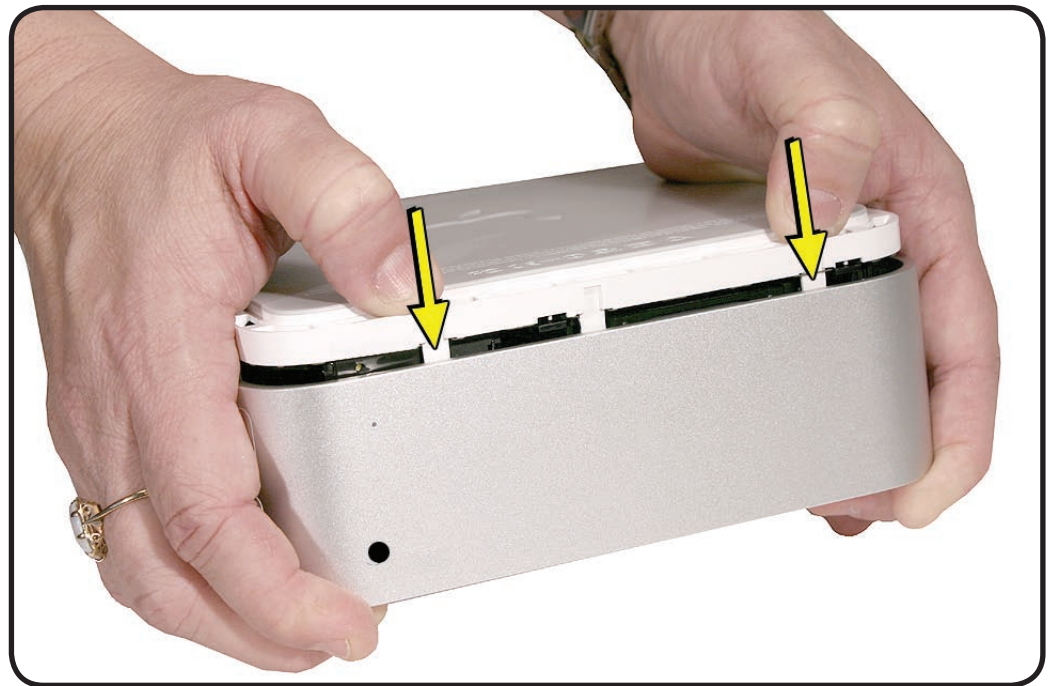





# Internal Frame

## First Steps

Remove:

- Top housing



## Tools

- Phillips #0 screwdriver
- Black stick

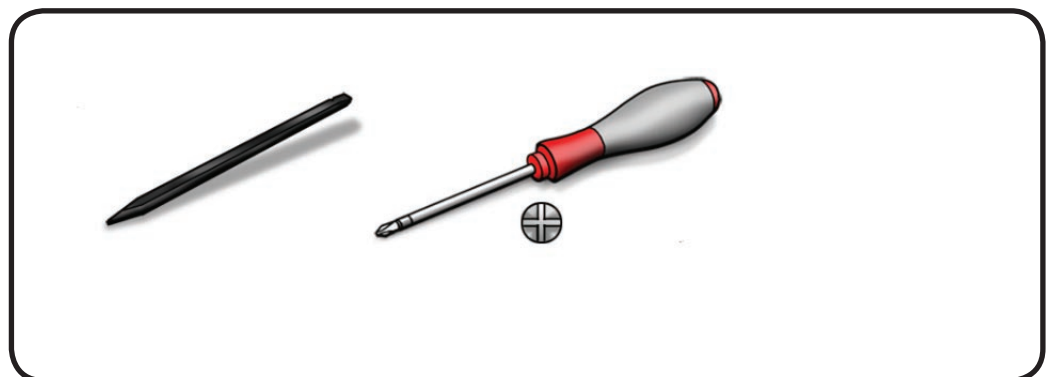



## Removal

**Note:** Depending on the configuration, the internal frame will either have an optical drive or a second hard drive installed on the internal frame. The internal frame removal procedure is the same for both.

- 1 Locate 3 antennas internal frame.

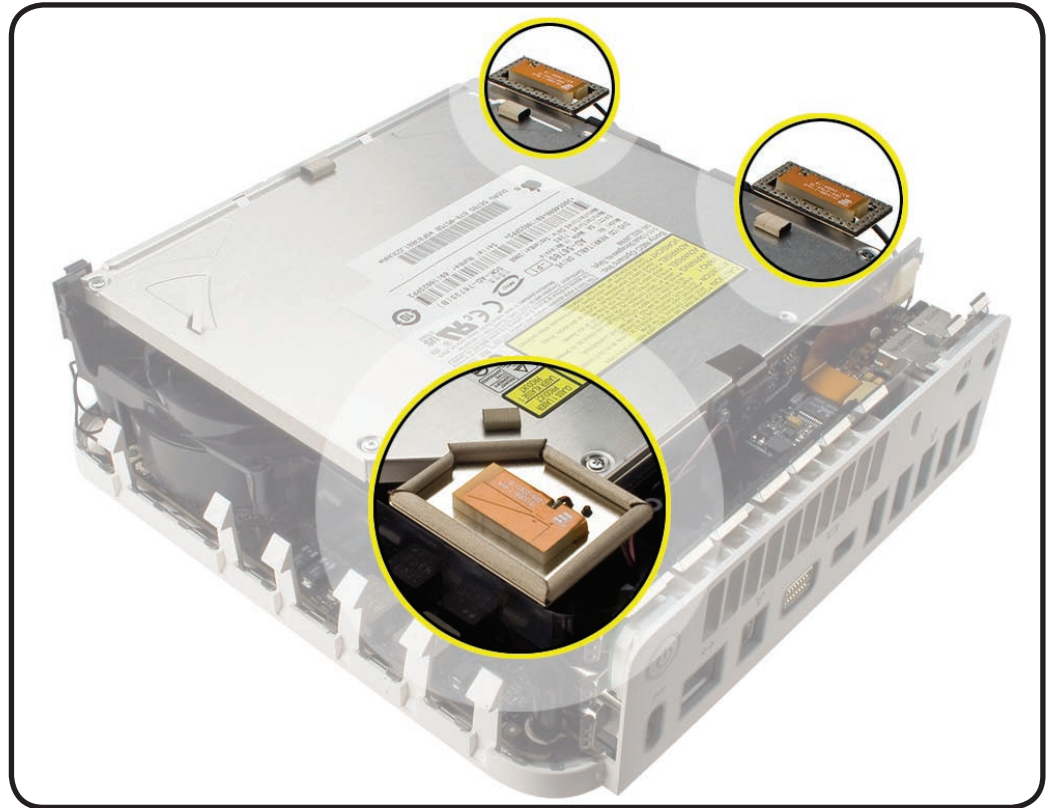

- 2 Squeeze black posts together and pull AirPort antenna board straight up and off the post.

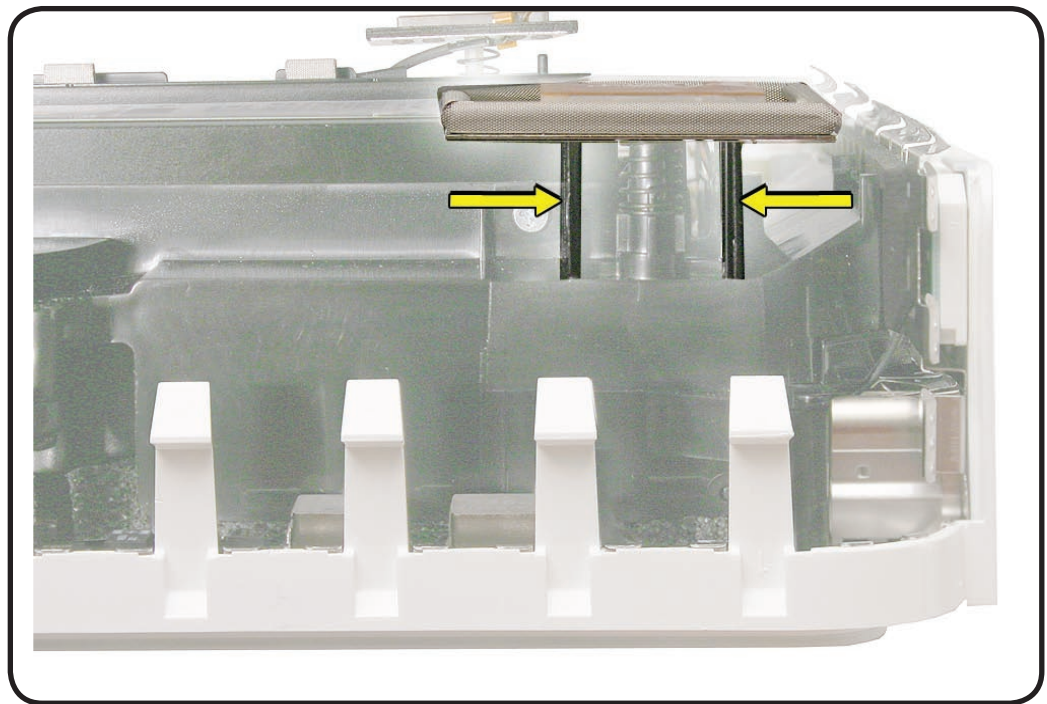



- 3 Pull the 2 other antennas straight up and off the spring posts.

**Important:** Leave antennas connected to the AirPort/Bluetooth card unless you are replacing the antennas or the AirPort/Bluetooth card.

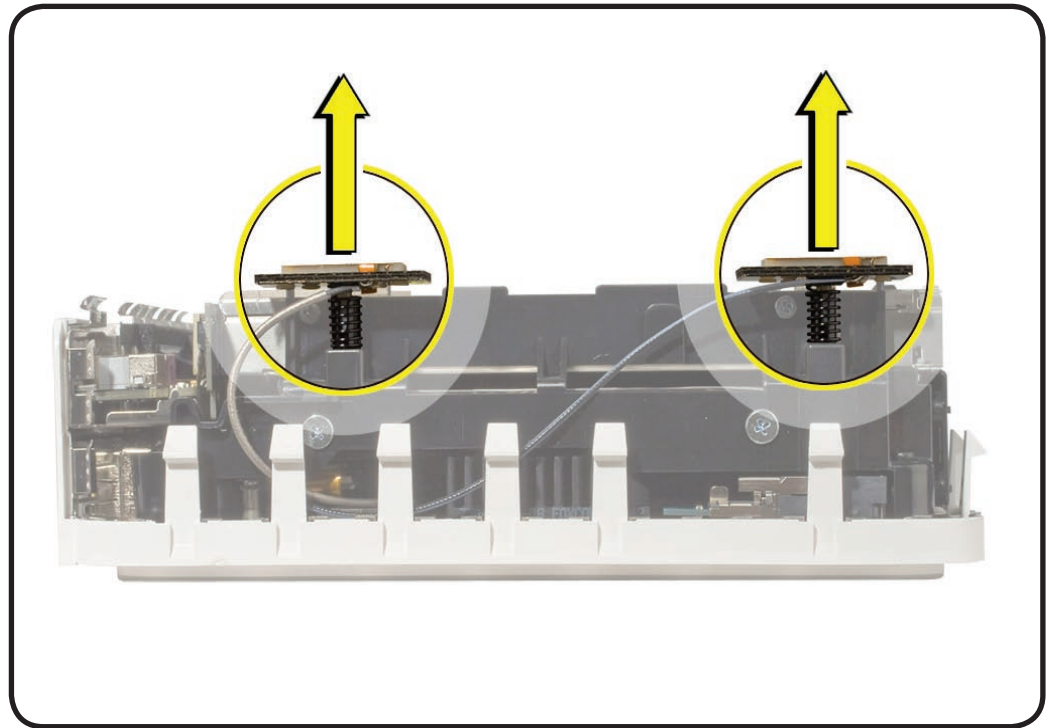

- 4 With a black stick, disconnect the audio flexible cable from interconnect board.

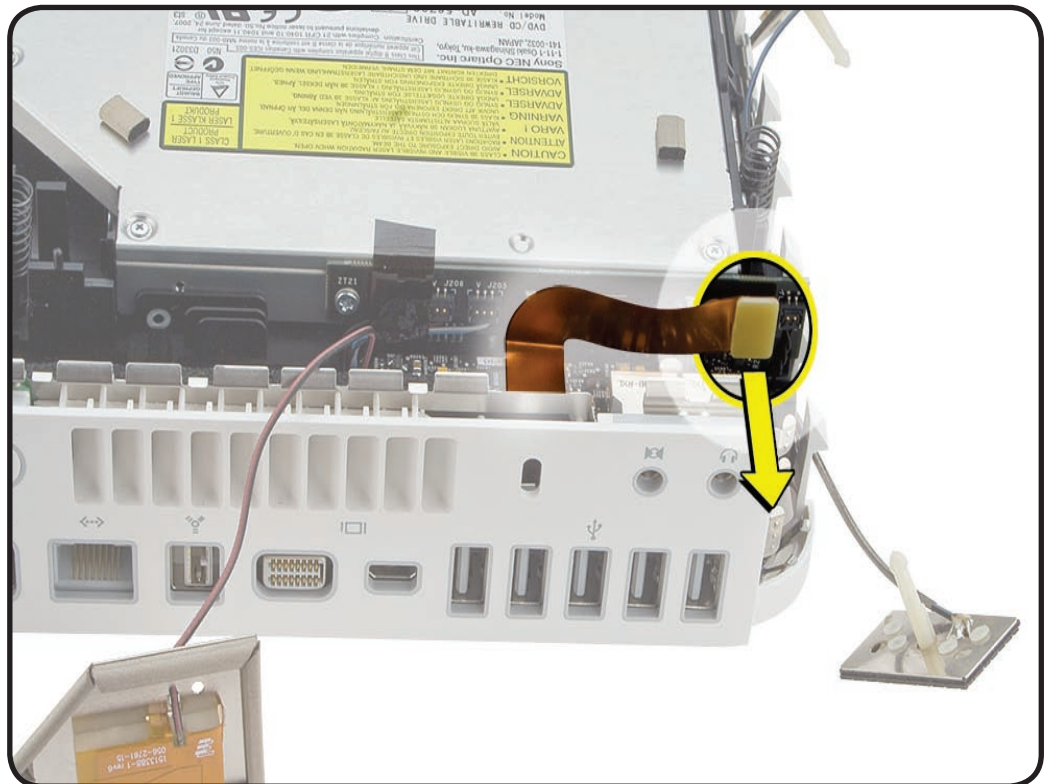



5 Remove 4 internal frame screws, located in each corner:

- 3 (922-7325)



- 1 longer screw, near power on LED (922-7324)

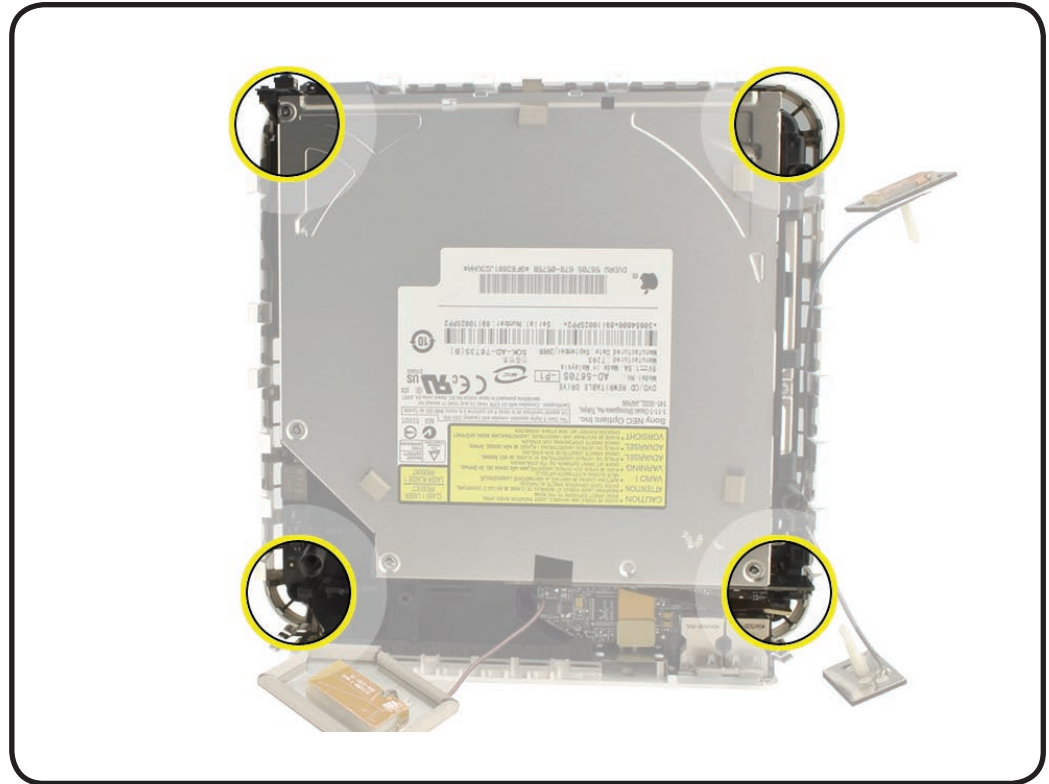

6 Lift internal frame up and off bottom housing.

**Important:** Leave antennas connected to the AirPort/Bluetooth card unless you are replacing the antennas or the AirPort/Bluetooth card.

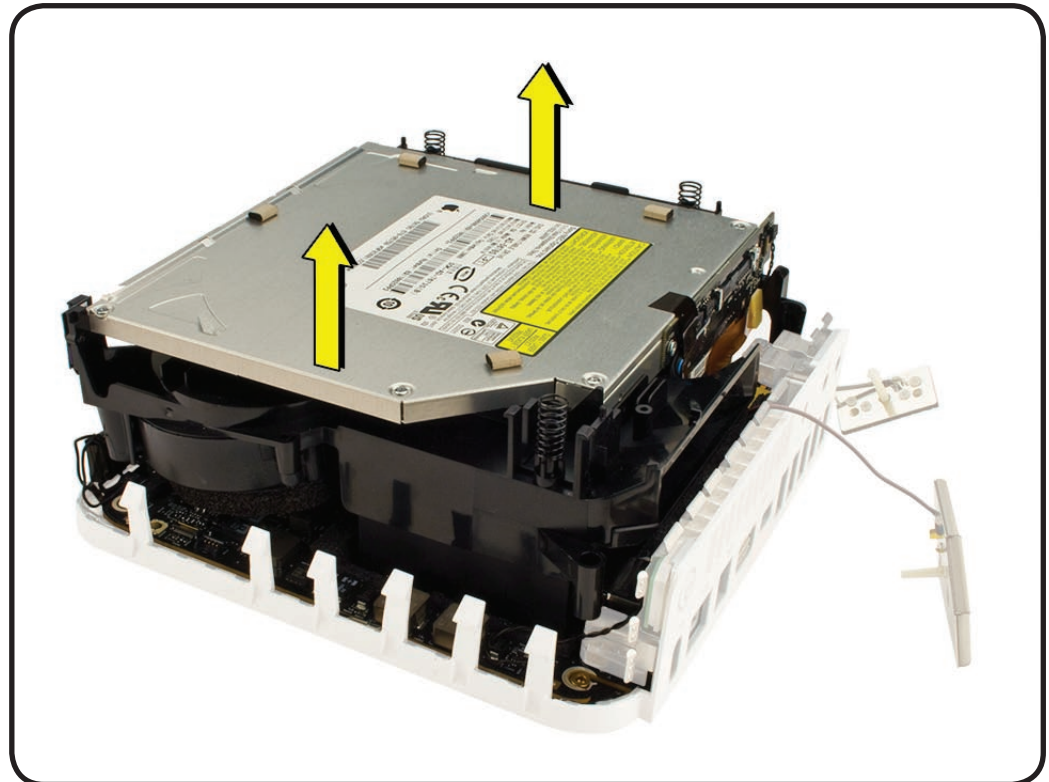



## Reassembly

- 1 Replace the internal frame.
- 2 Route the 2 antennas (on the side) so they are out of the way of the internal frame.

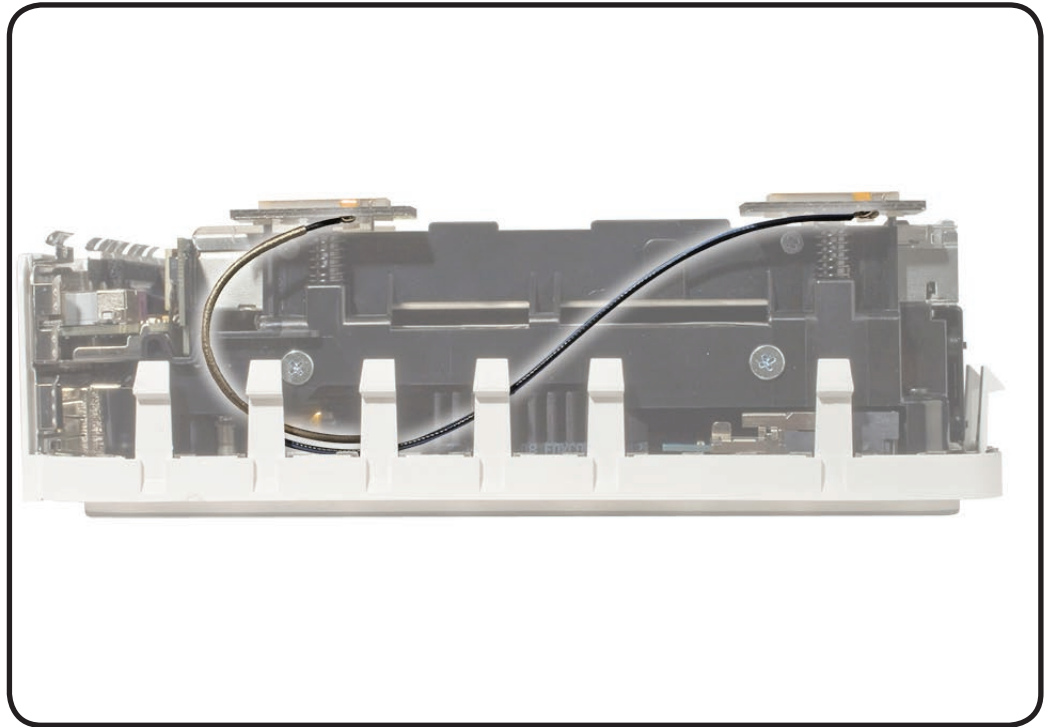

- 3 Route the AirPort antenna up through opening in internal frame.
- 4 Tuck antenna into cable channel on internal frame.

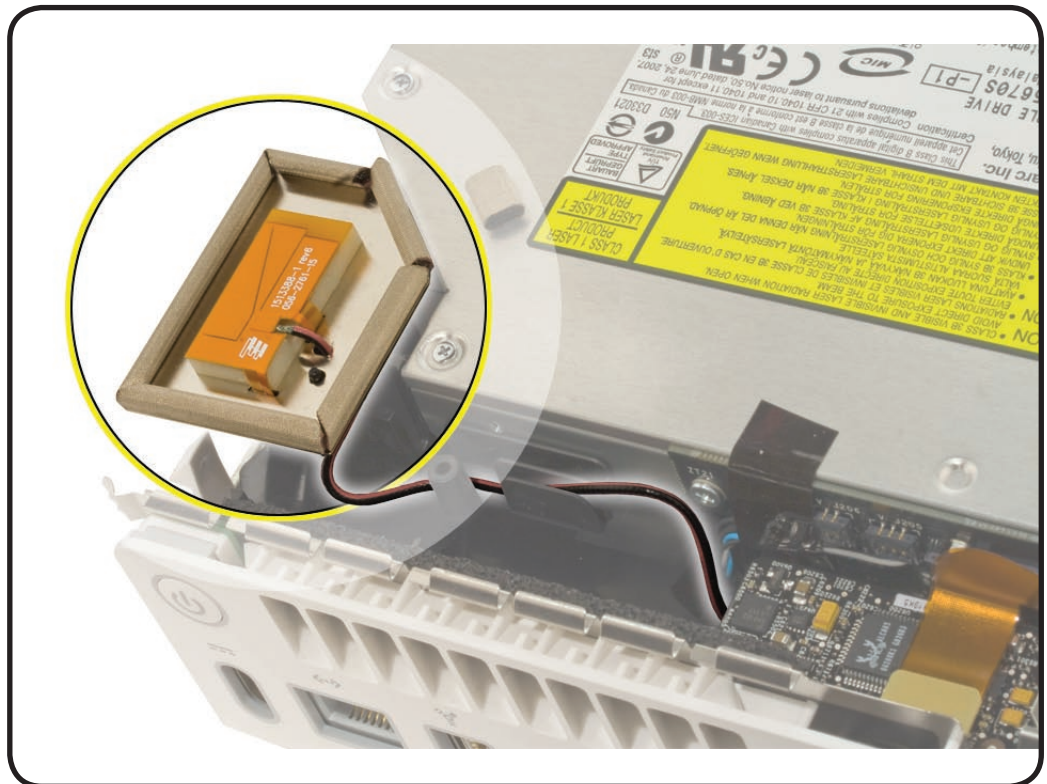



- 5 Check that the power button cable is not pinched by the internal frame.

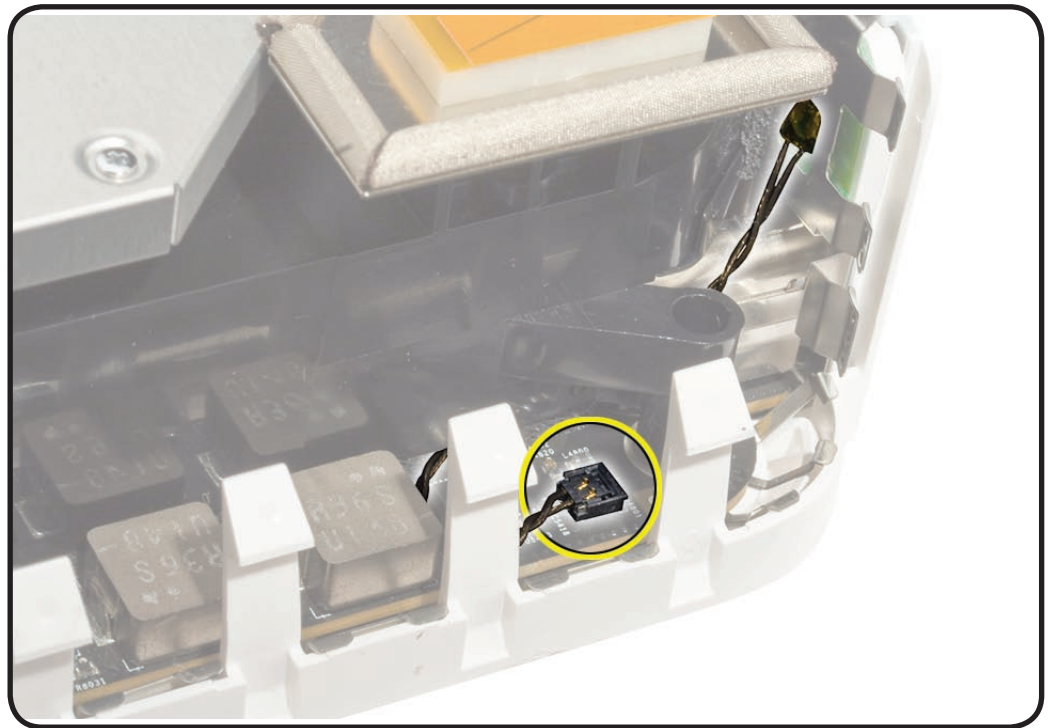



# Antennas

## First Steps

Remove:

- Top housing

**Important:** If one antenna fails, **all** 3 antennas must be replaced because they are paired. Order kit 076-1352 for Mac mini (Late 2009) configurations.

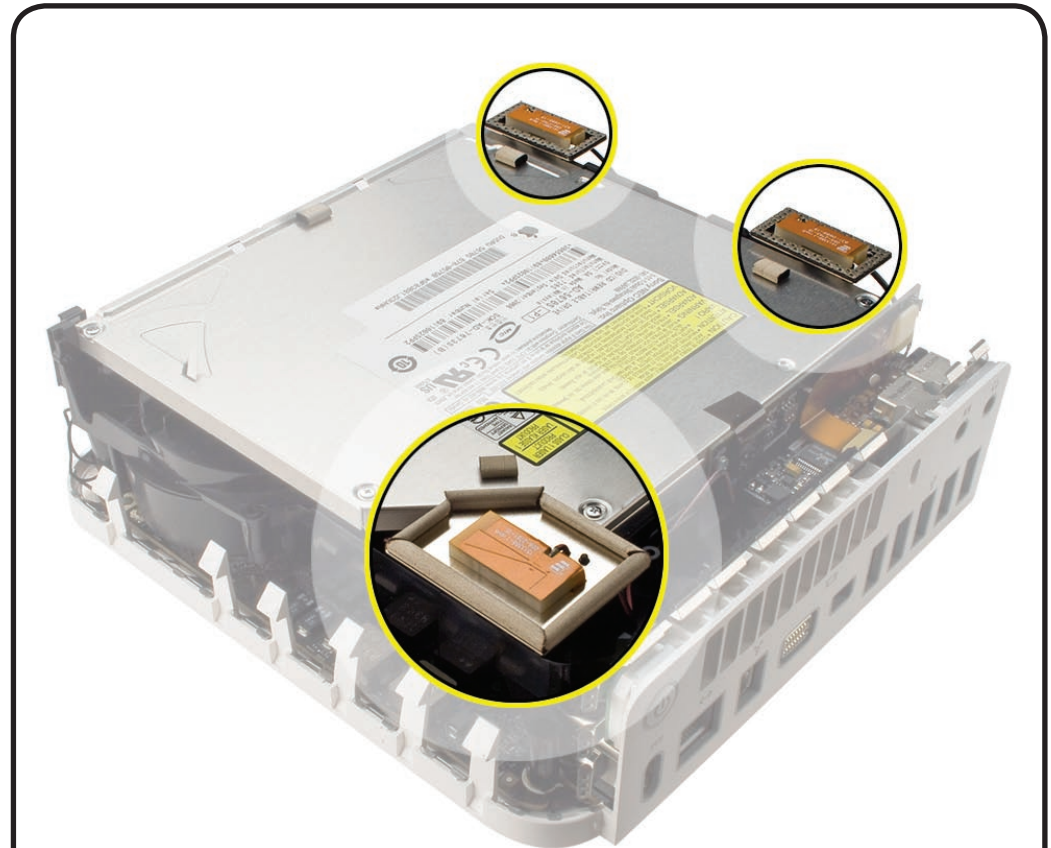

## Tools

- Phillips #0 screwdriver
- Black stick





## Removal

- 1 Squeeze black posts together and pull AirPort antenna board straight up and off the post.

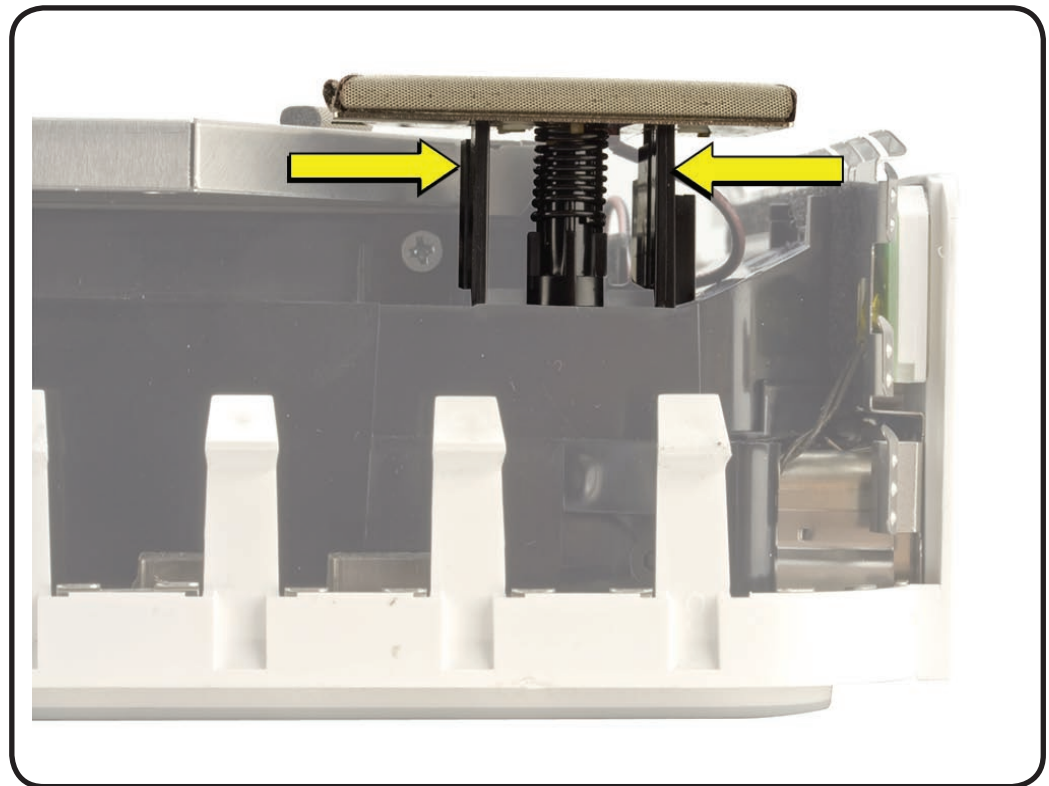

- 2 Rotate the computer 180 degrees.

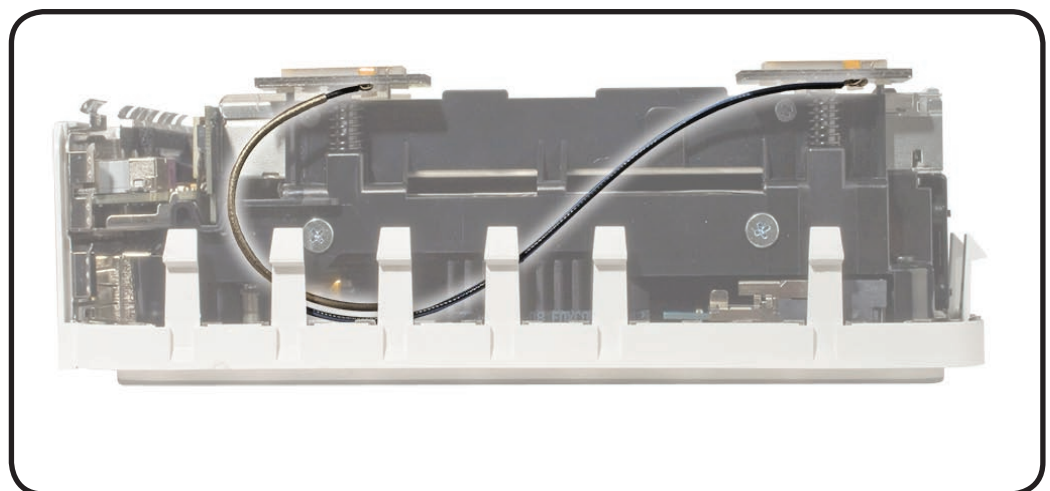





3. Pull each antenna straight up and off the spring posts.

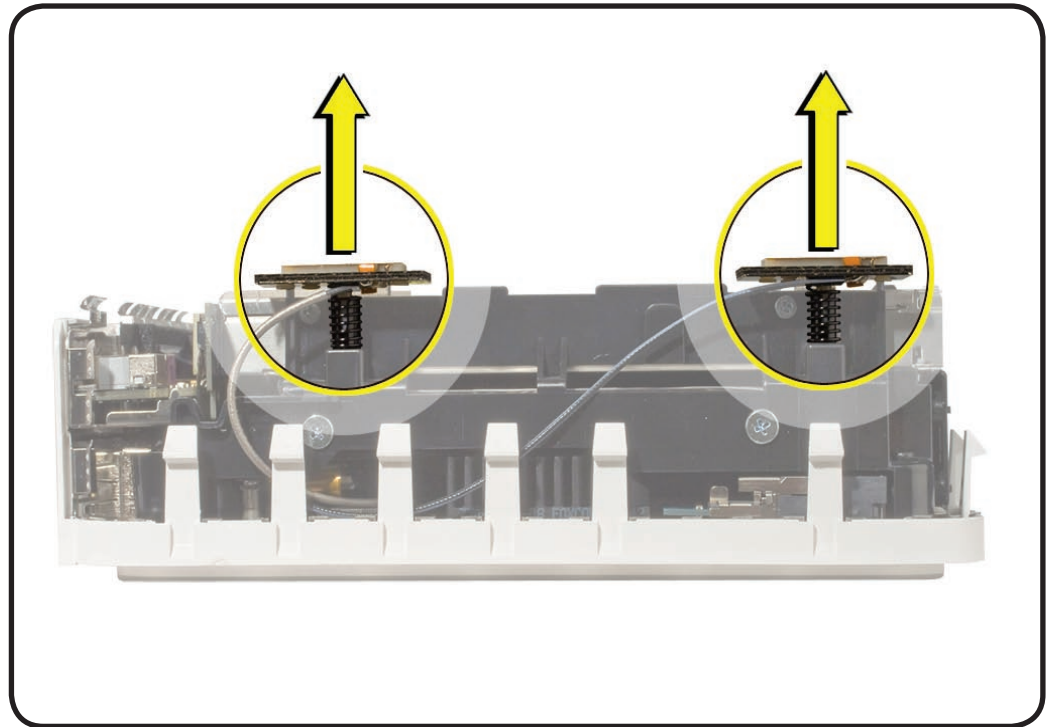

- 4 Remove internal frame.  
**Important:** Leave antennas connected to the AirPort/Bluetooth card unless you are replacing the antenna or the AirPort/Bluetooth card.

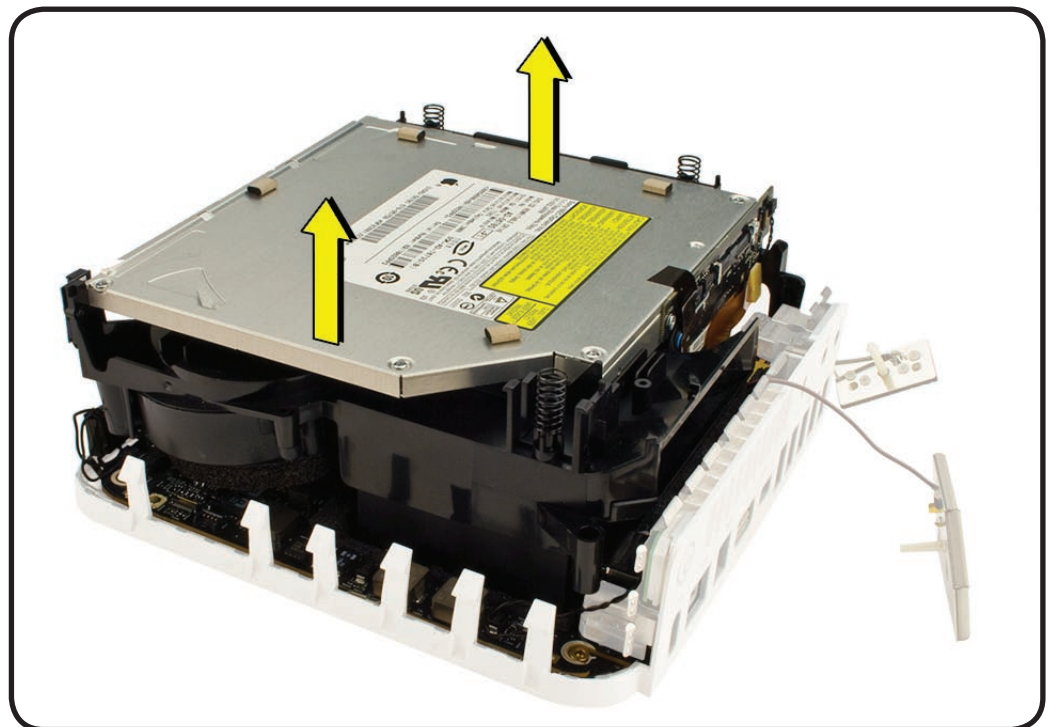



- 5 On the AirPort/Bluetooth card, **carefully** disconnect
- red antenna from J3
  - gray antenna from J2
  - blue antenna (Bluetooth) from J4
  - flexible AirPort/Bluetooth cable

**WARNING:** Be careful not to damage the antenna connectors as it may induce antenna or AirPort/Bluetooth card replacement.

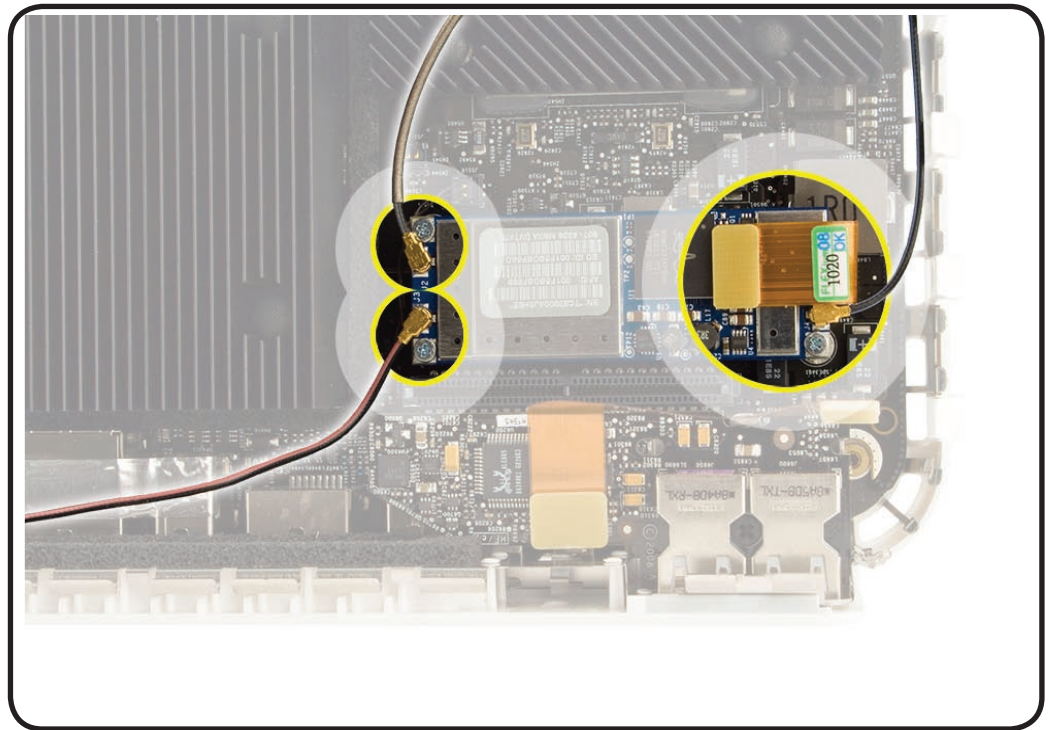

- 6 Lift antennas out of computer.

## Reassembly

- 1 Route the antennas so they aren't pinched when the internal frame is replaced.

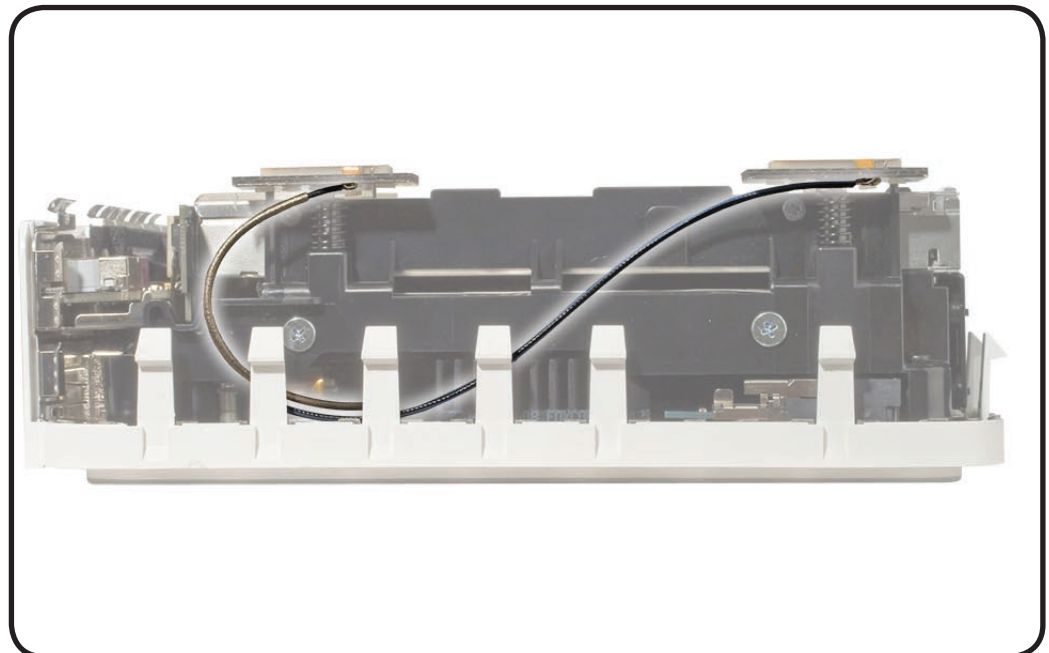



- 2 Route antenna up through the frame and into cable channel on the internal frame.

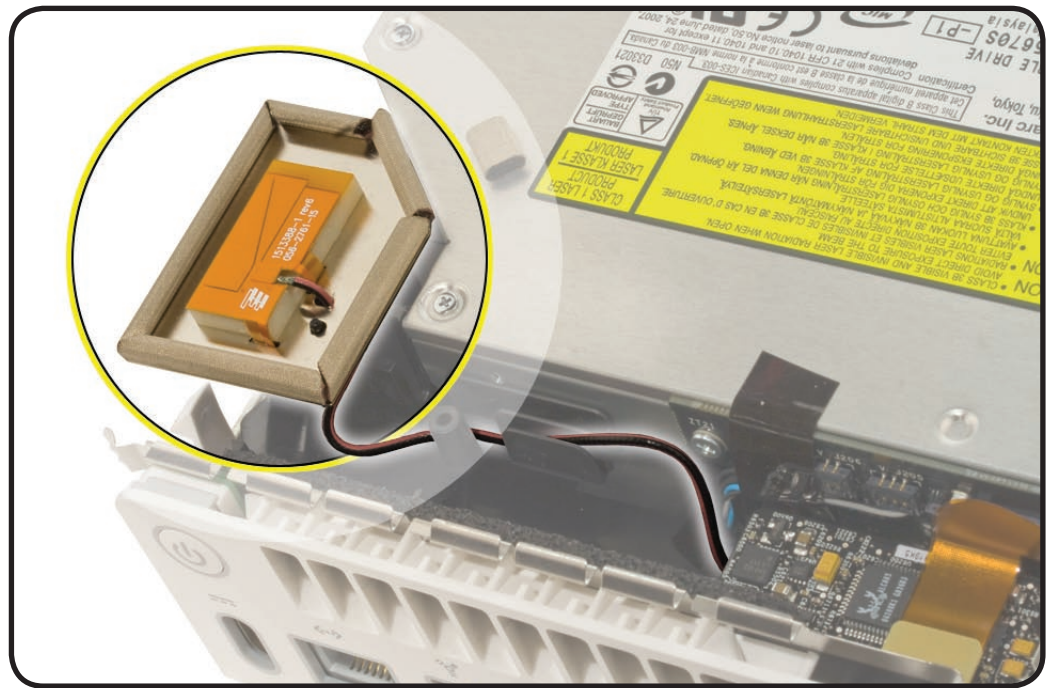



# Memory

## First Steps

Remove:

- Top housing
- Internal frame

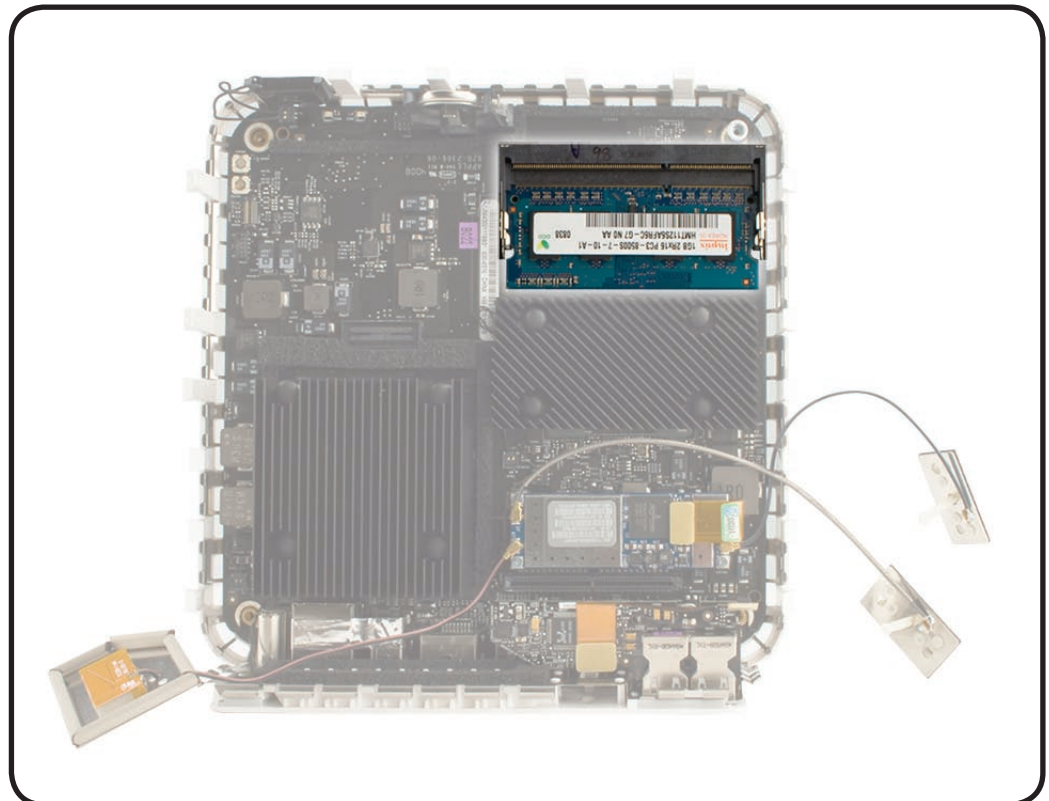

## Tools

- Black stick





## Removal

- 1** Press the latches on the DIMM socket outward.
- 2** The DIMM will pop up slightly.
- 3** Remove the DIMM from the slot.

**Replacement Note:**

Press DIMM into socket and press downward until DIMM clicks into place.

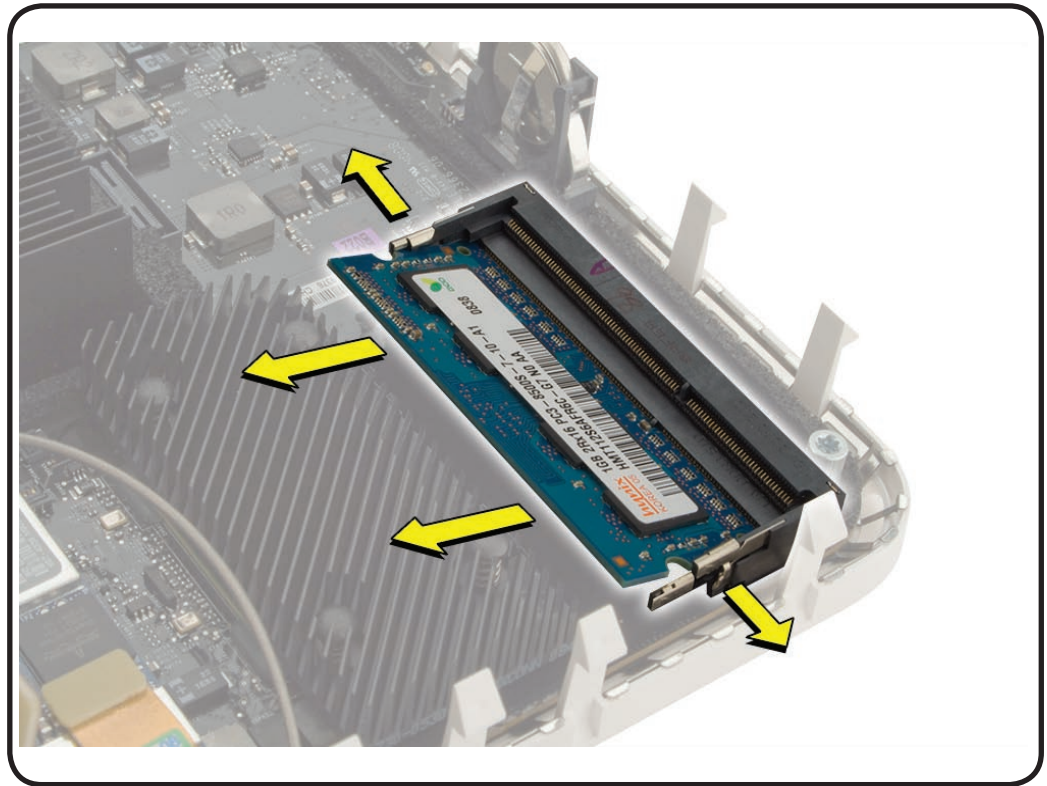



# Audio Board

## First Steps

Remove:

- Top housing

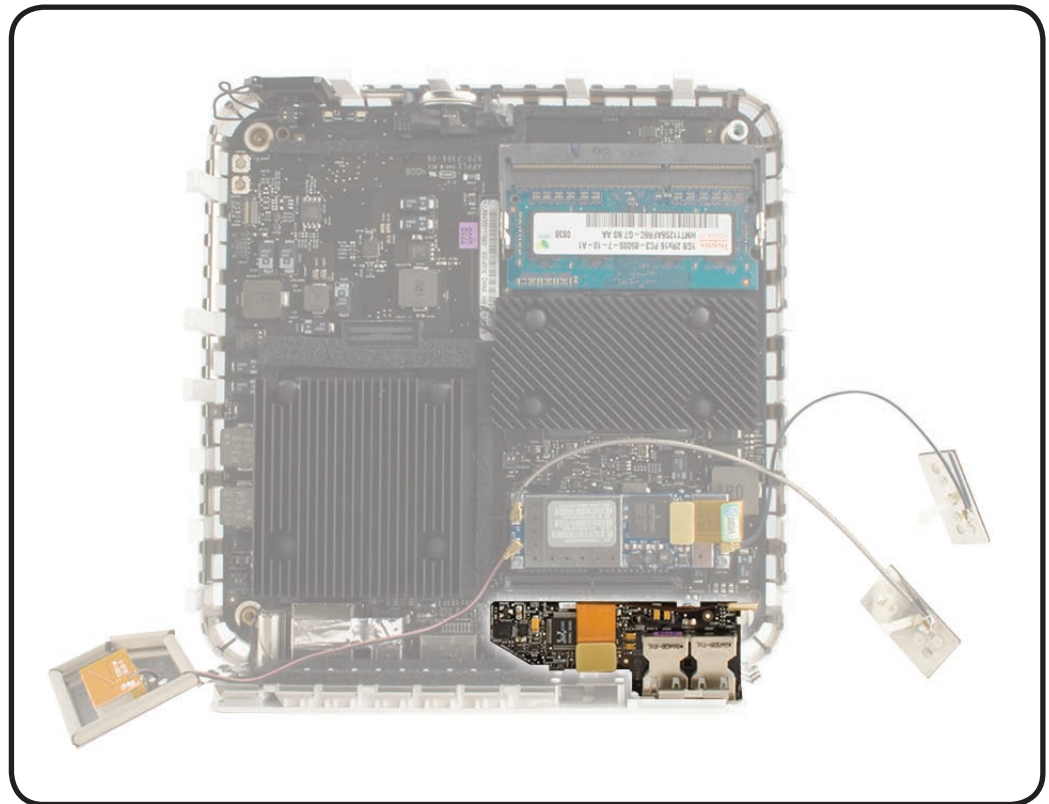

## Tools

- Phillips #0 screwdriver
- Black stick

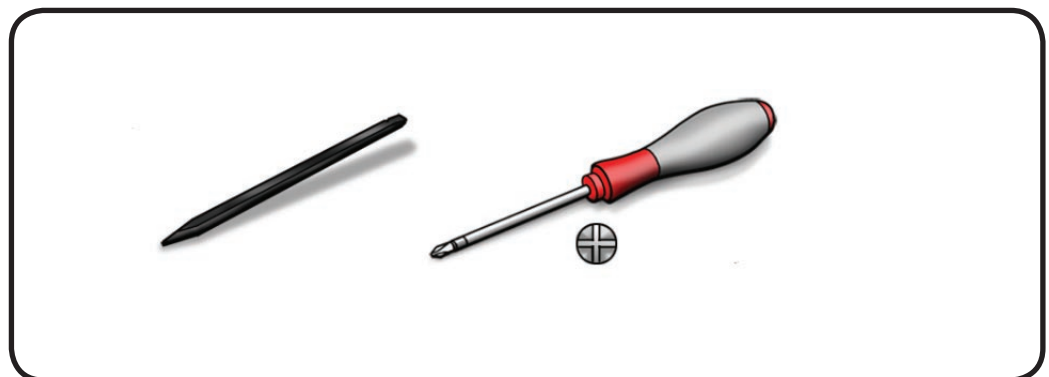



## Removal

- 1 Disconnect audio flex cable from interconnect board.

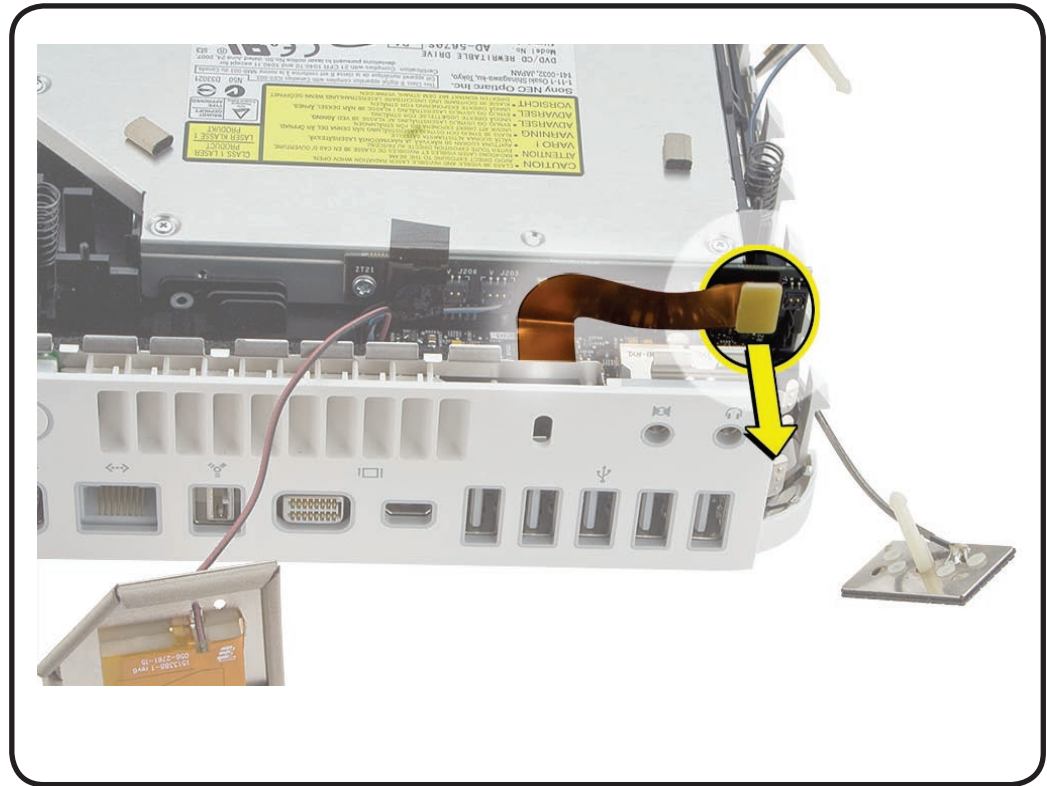

- 2 Remove internal frame.  
**Note:** It's possible to remove the audio board without removing the internal frame, but for visual reference it has been removed.

- 3 Remove 1 screw 922-7325.

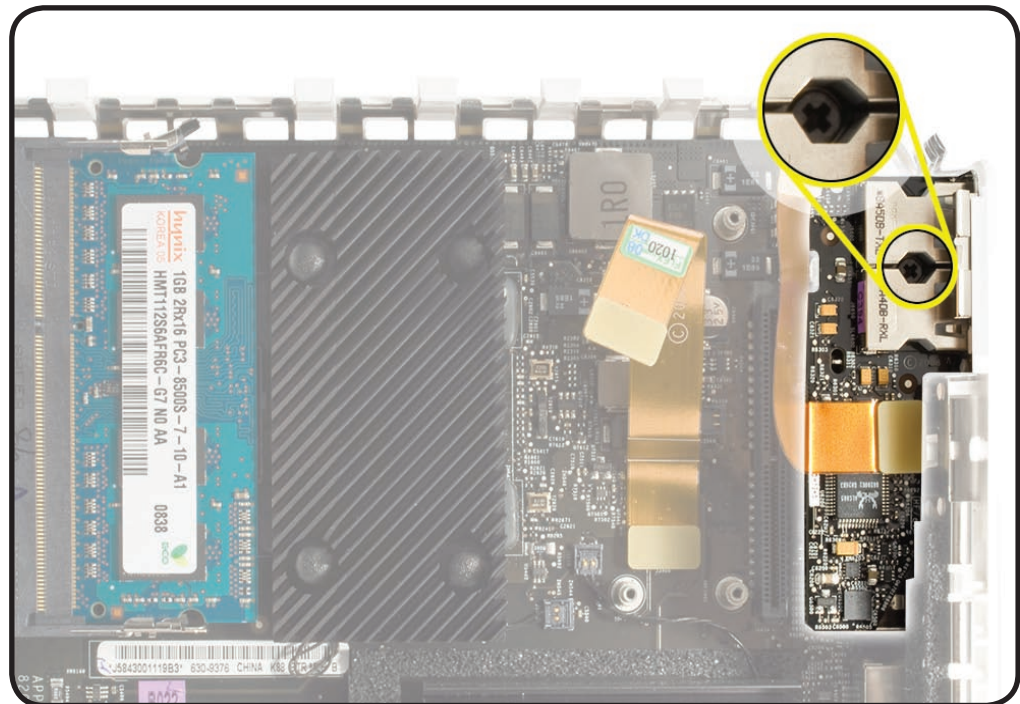



- 4 With a black stick or your finger, pull back on the metal tab to release the board from the bracket.

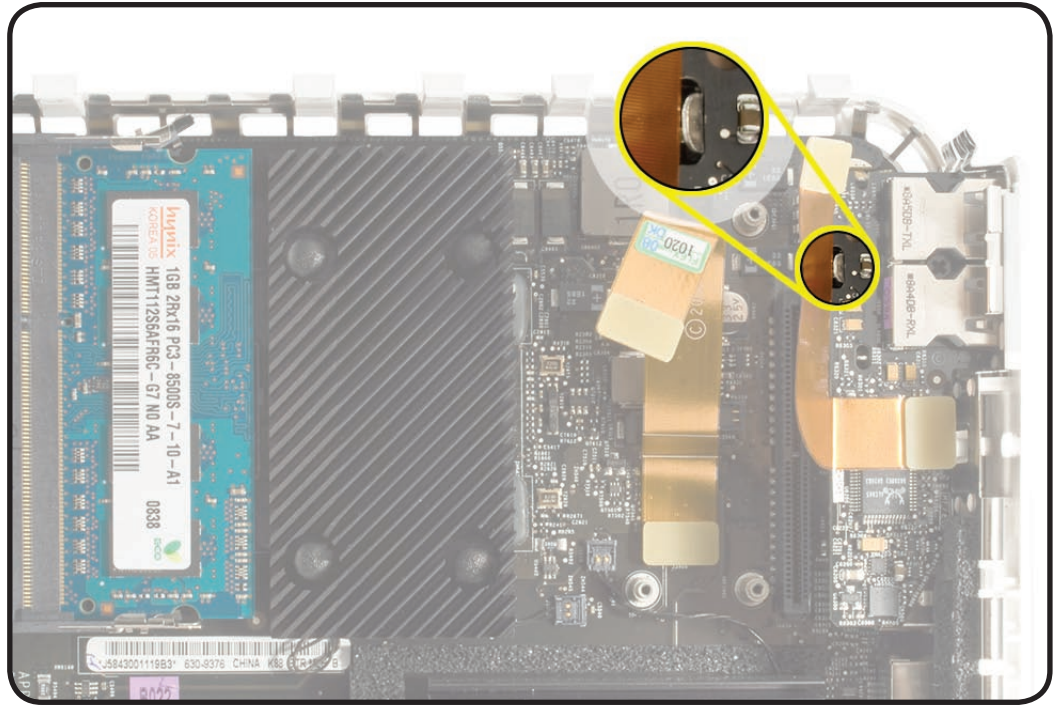

- 5 Carefully remove the audio board from I/O ports.

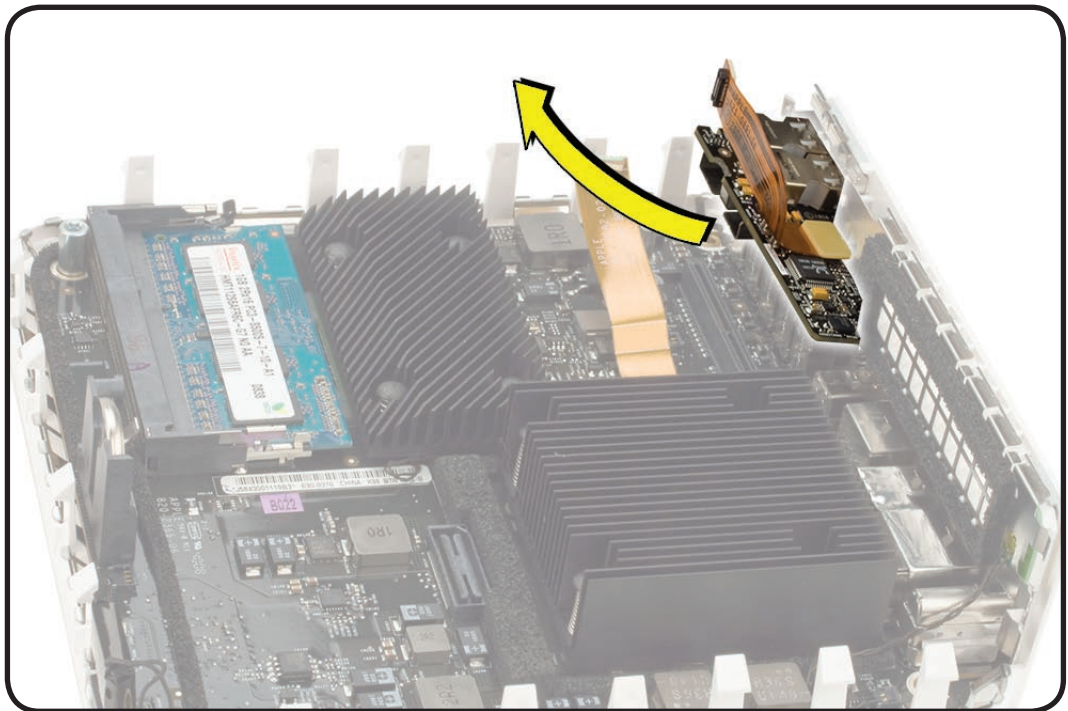





## Reassembly

- 1 Position audio board ports under metal tabs on the bottom housing.

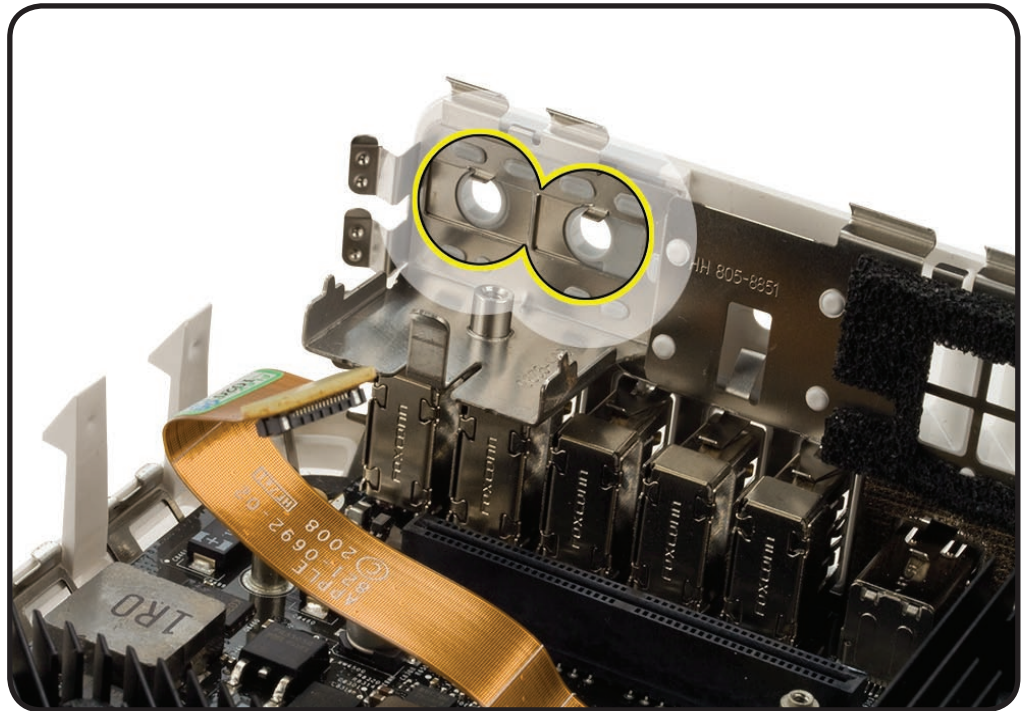

- 2 Pull back on the metal tab and seat the audio board into the ports on the bottom housing.
- 3 Test the alignment by inserting a headphone connector into the headphone jack.

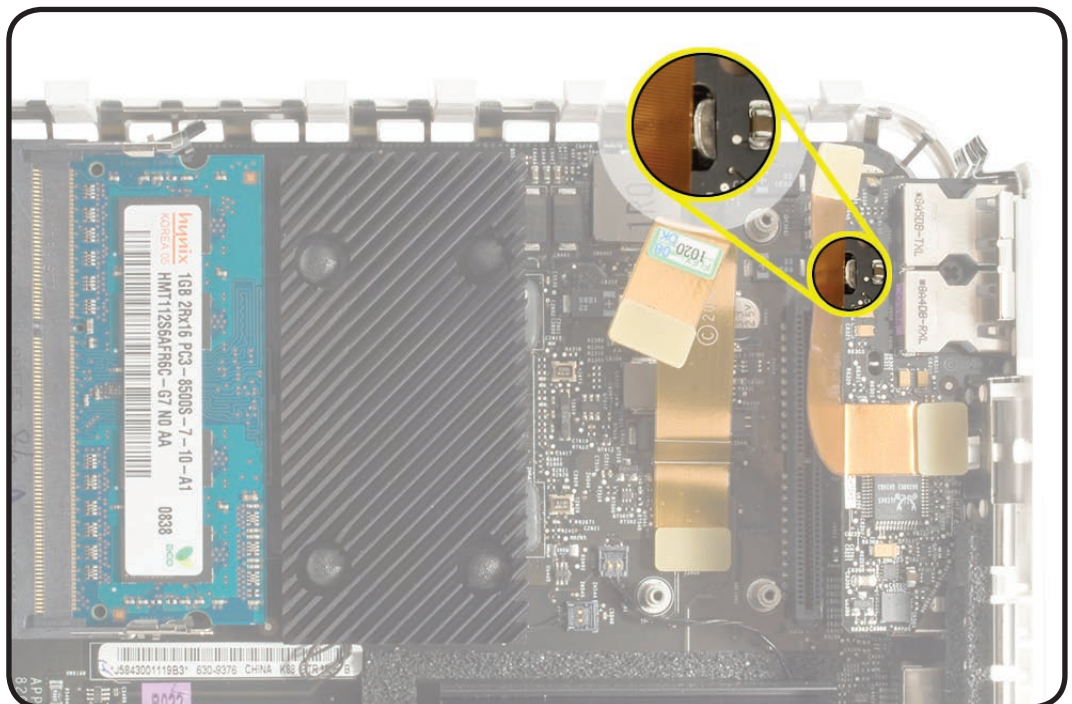



# AirPort/Bluetooth Combo Card

## First Steps

Remove:

- Top housing
- Internal frame

**Important:** Leave antennas connected to the AirPort/Bluetooth card unless you are replacing the antennas or the AirPort/Bluetooth card.

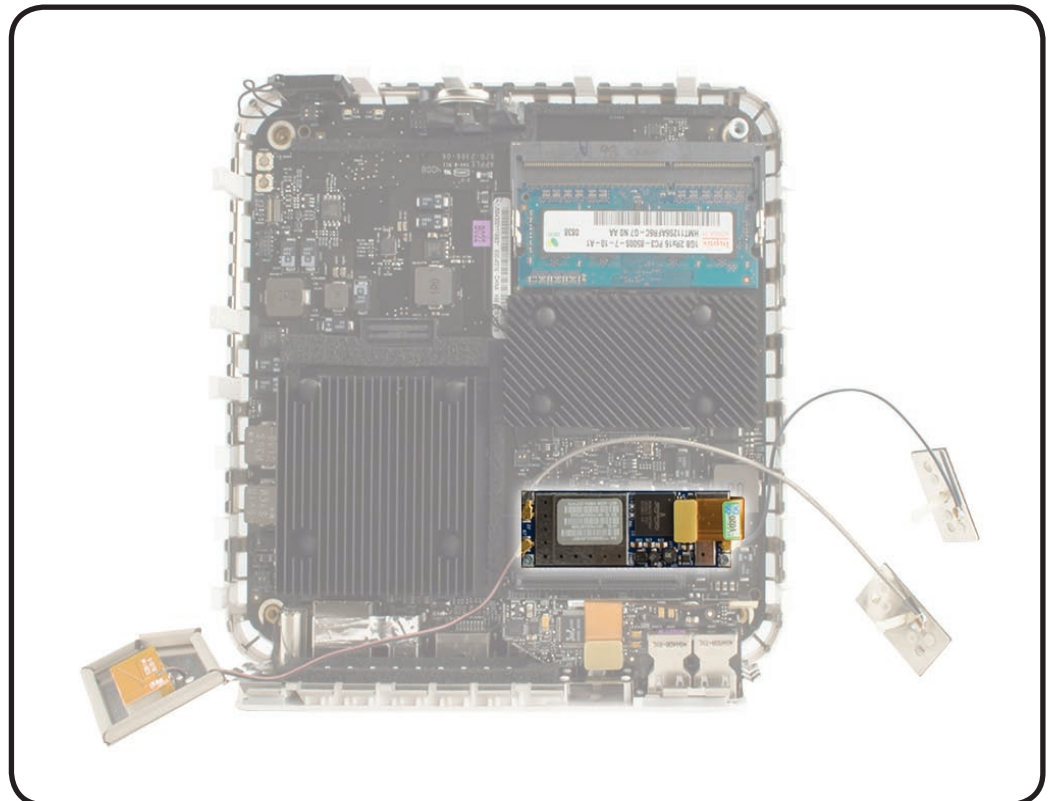

## Tools

- Phillips #0 screwdriver

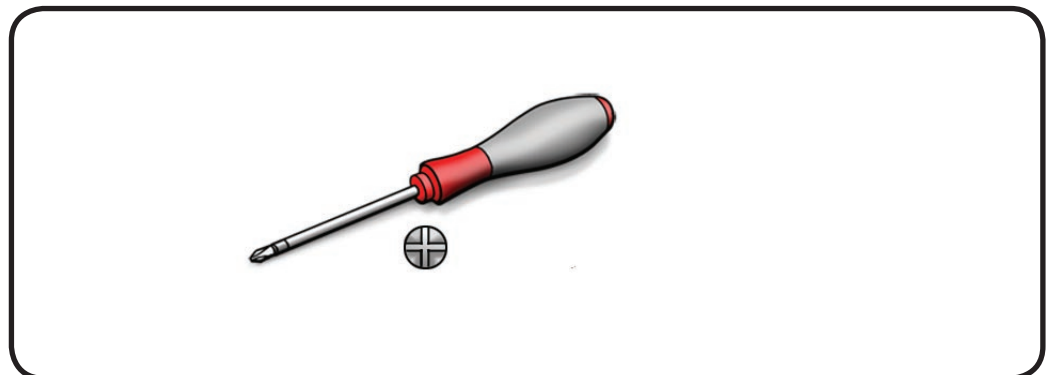



## Removal

- 1 Remove 3 screws 922-6680.



- 2 Disconnect the orange flexible Airport/Bluetooth cable.
- 3 Lift the AirPort/Bluetooth card out of the computer with antennas attached.

**Important:** Leave antennas connected to the AirPort/Bluetooth card unless you are replacing the antennas or the AirPort/Bluetooth card.

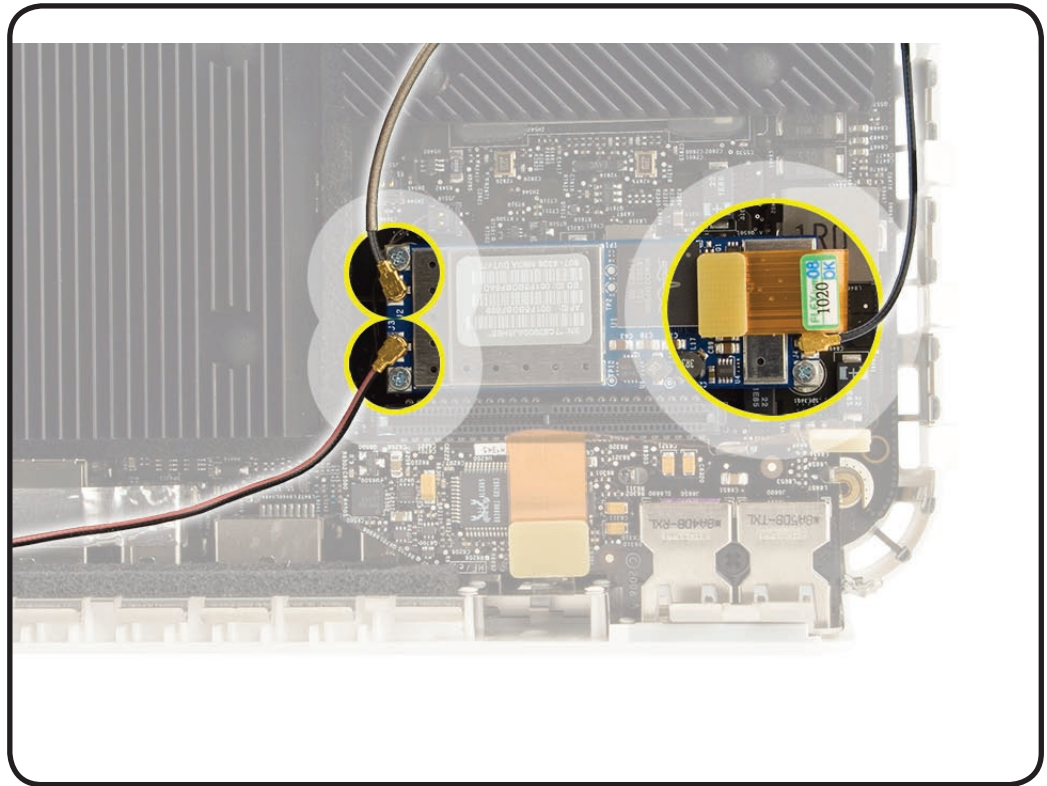



# IR Board and Cable

## First Steps

Remove:

- Top housing
- Internal frame

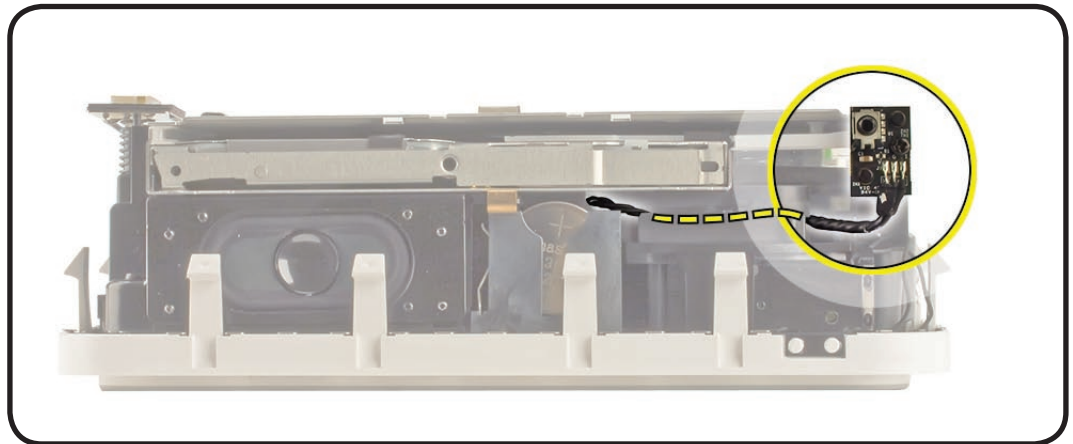

## Tools

- Phillips #0 screwdriver
- Black stick

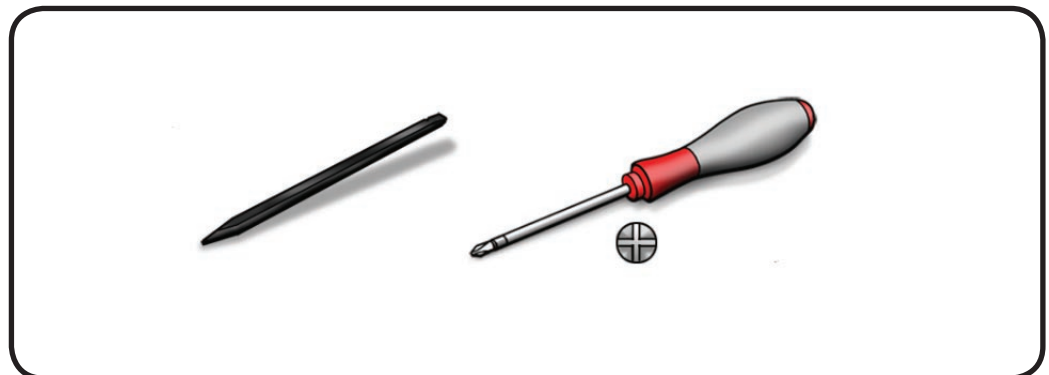



## Removal

- 1 Remove 1 screw 922-8820.



- 2 Note the IR cable routing within the internal frame before you disconnect the cable from the interconnect board.

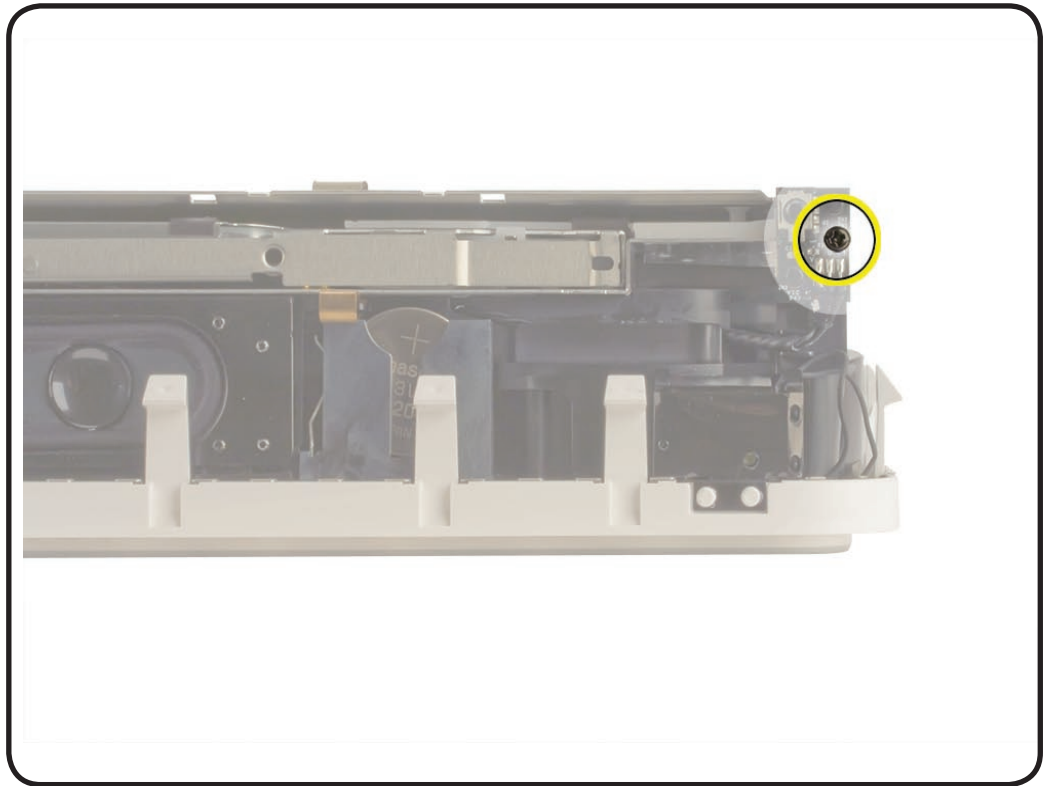

- 3 Remove the IR cable from the cable channel.

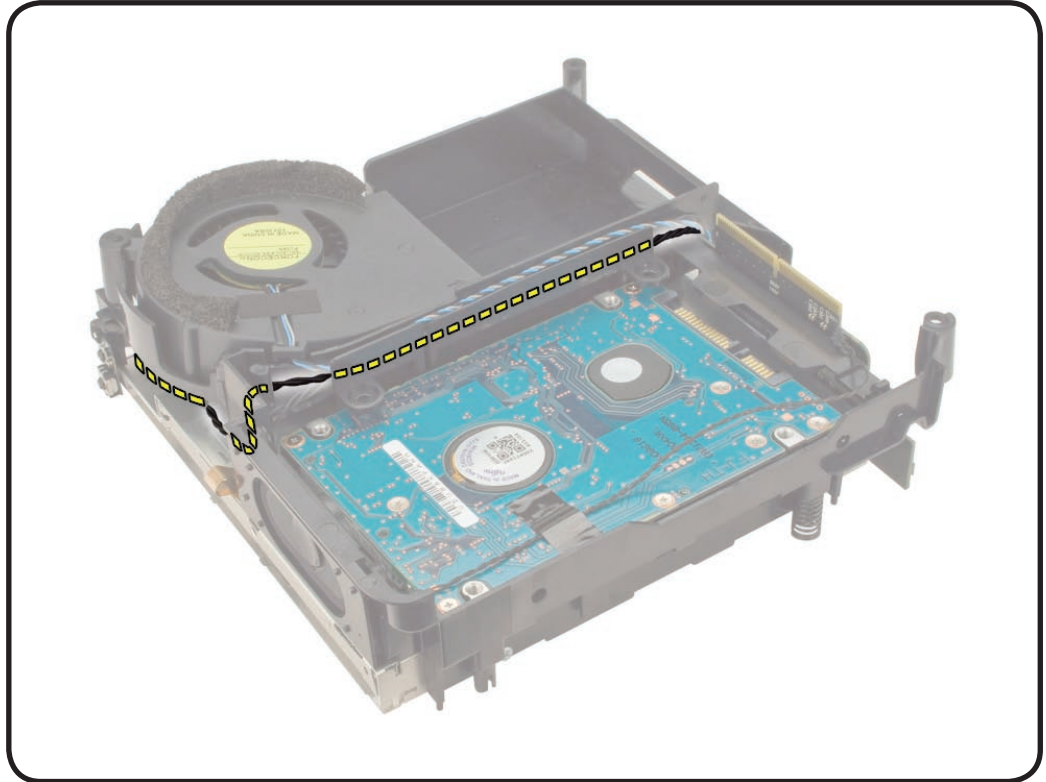



- 4 Disconnect IR cable from J211 on the interconnect board.

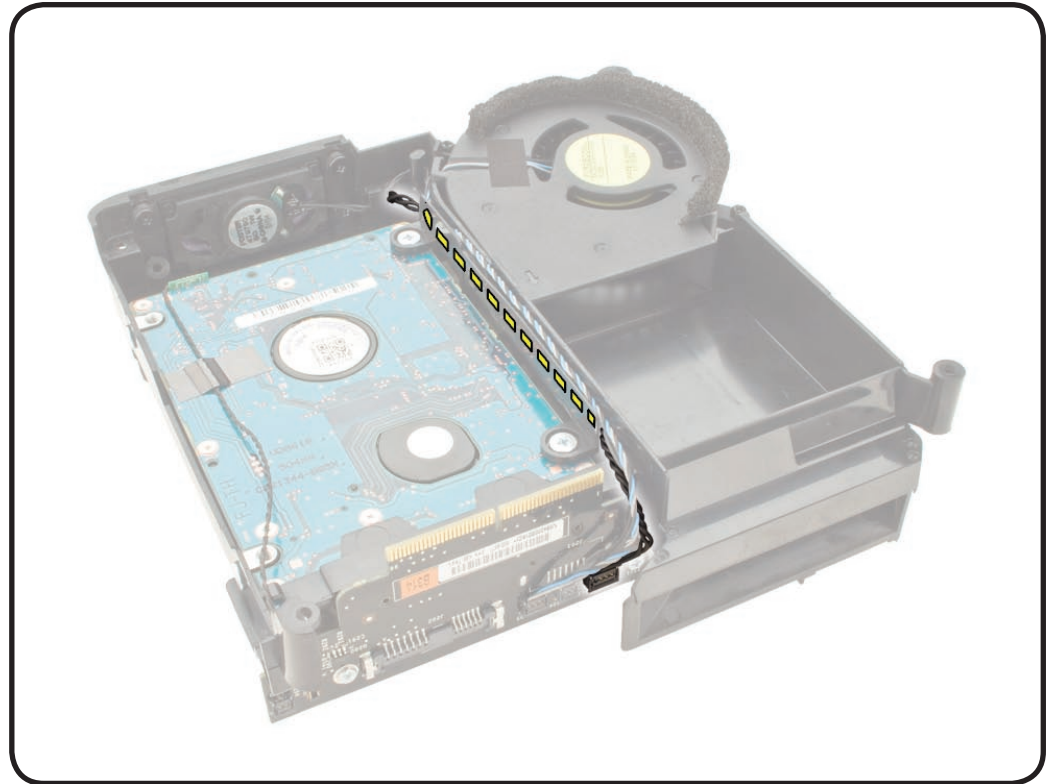



# IR Board and Cable (Late 2009)

## First Steps

Remove:

- Top housing
- Internal frame

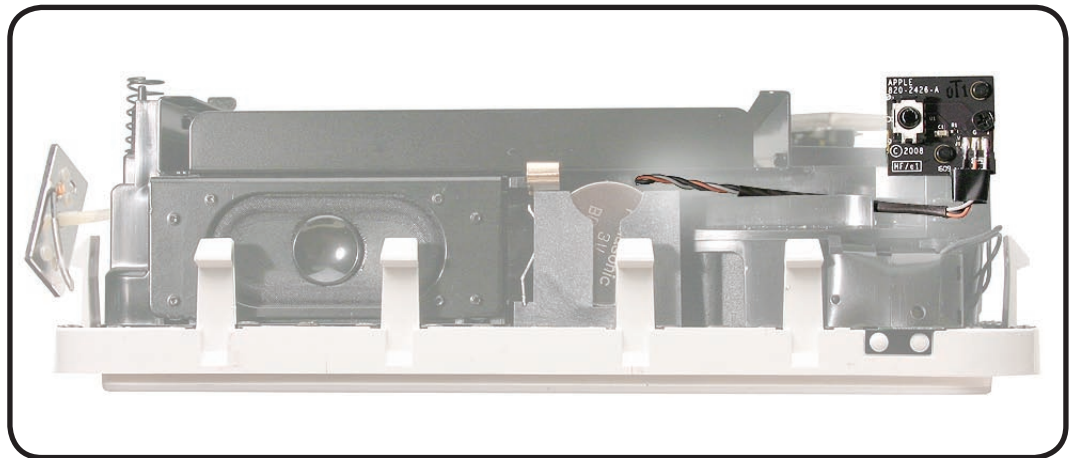

## Tools

- Phillips #0 screwdriver
- Black stick

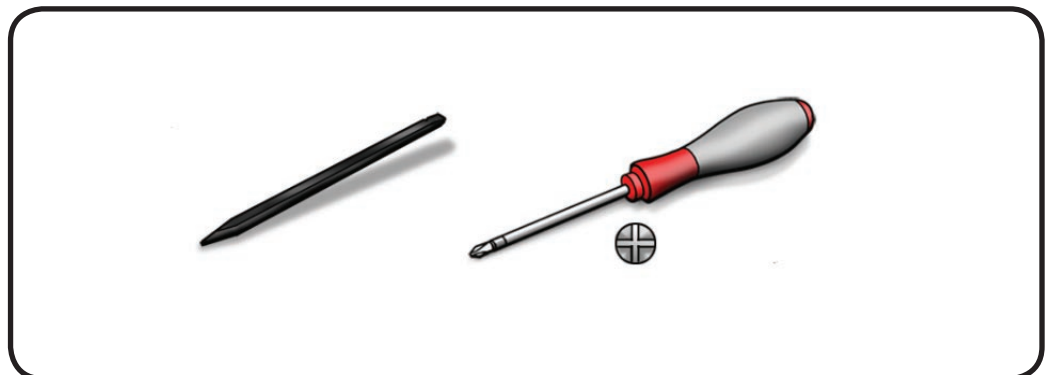



## Removal

- 1 Remove 1 screw 922-8820.

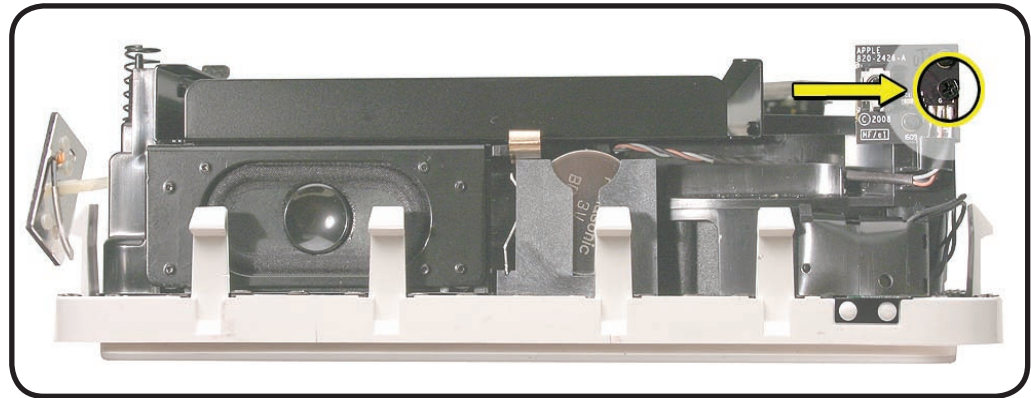

- 2 Note the IR cable routing within the internal frame before you disconnect the cable from the interconnect board.

- 3 Remove the IR cable from the cable channel.

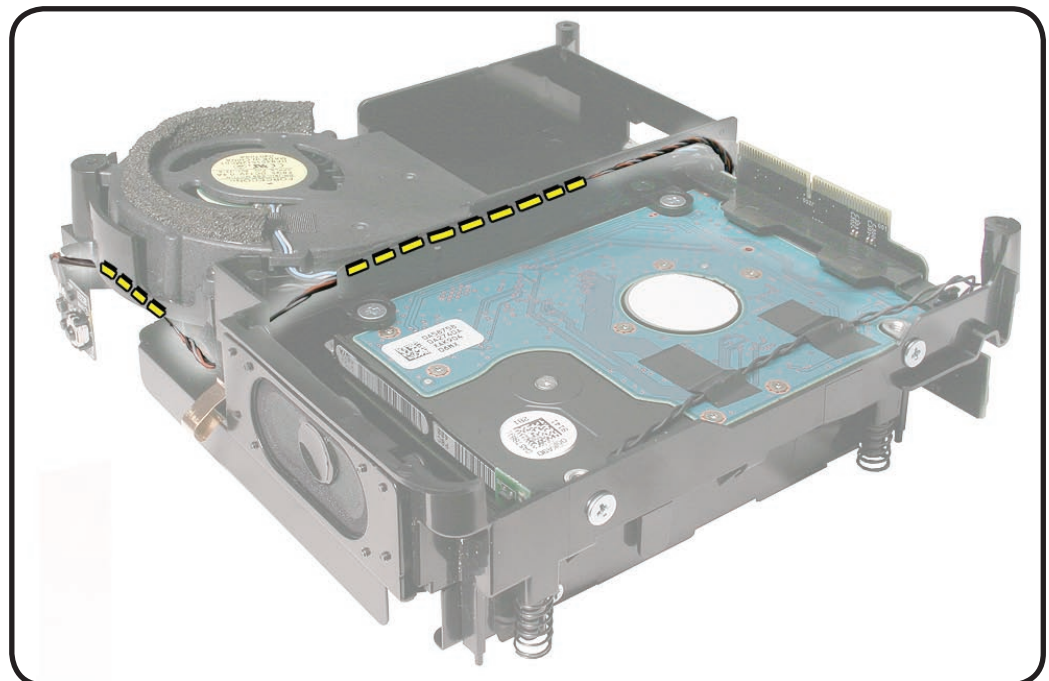





- 4 Disconnect IR cable (brown, gray, and black cable) from J211 on the interconnect board.

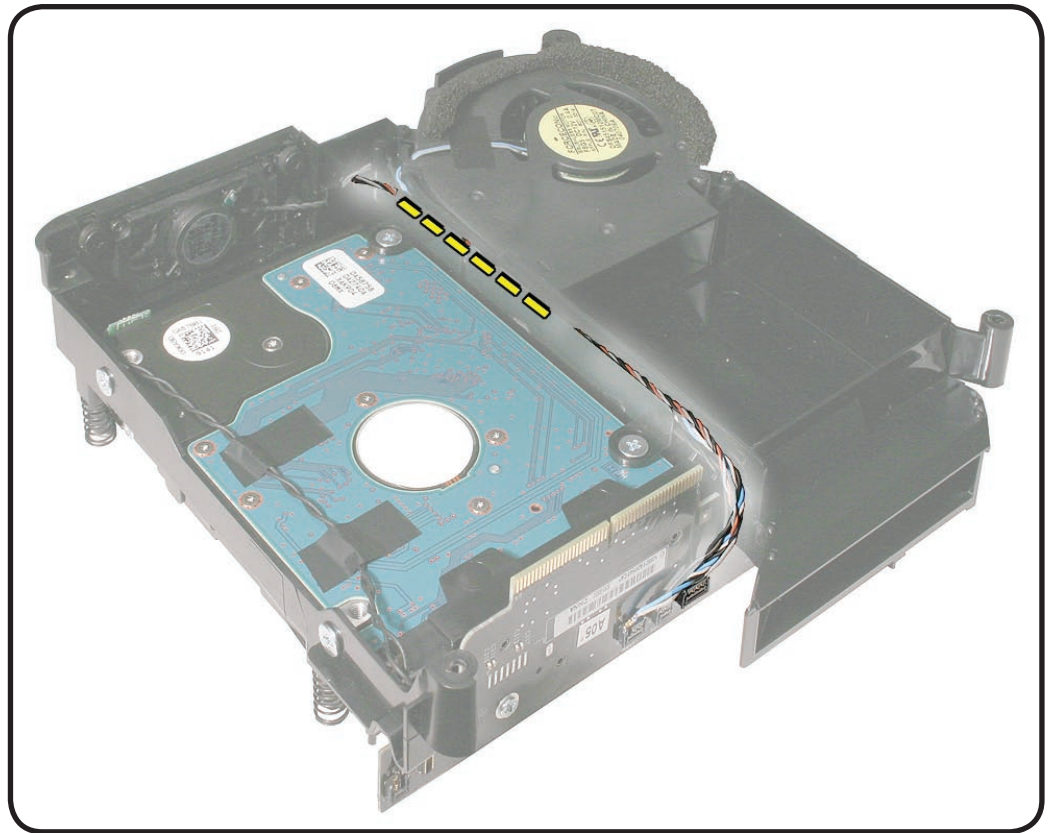



# Hard Drive Carrier (Late 2009)

## First Steps

Remove:

- Top housing
- Internal frame

**Note:** This carrier is used on the dual hard drive configuration only.

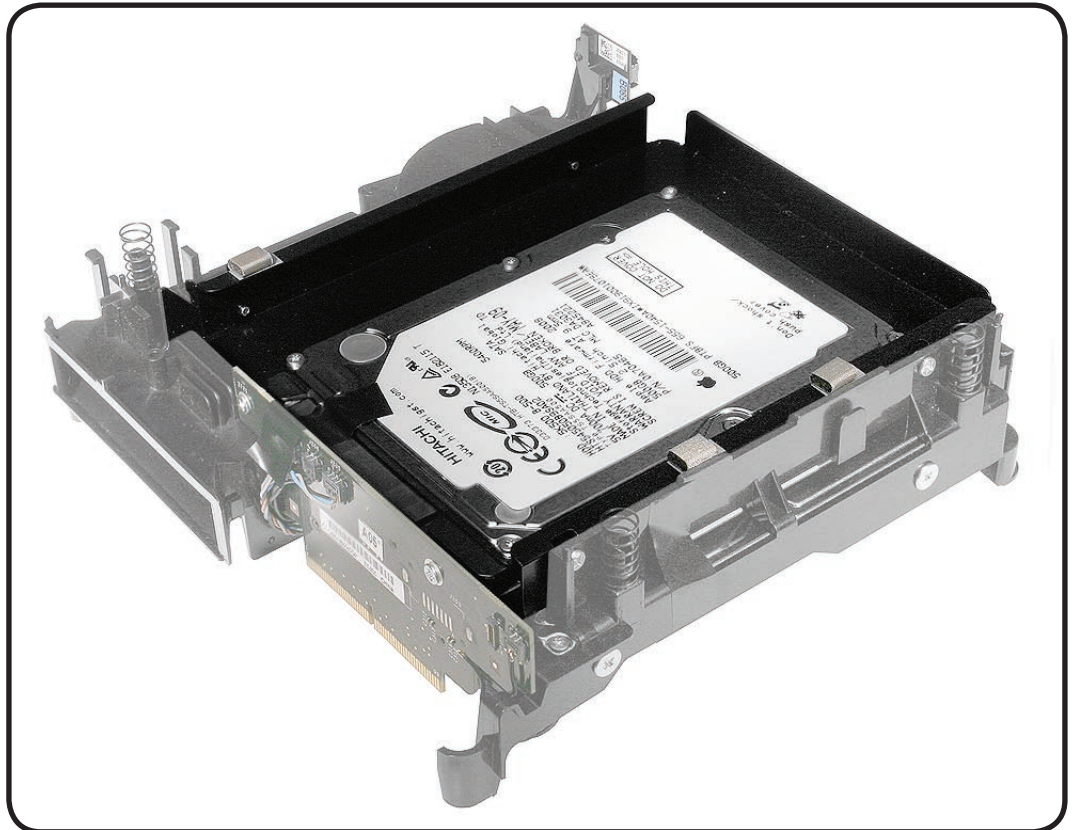

## Tools

- Phillips #0 screwdriver
- Black stick

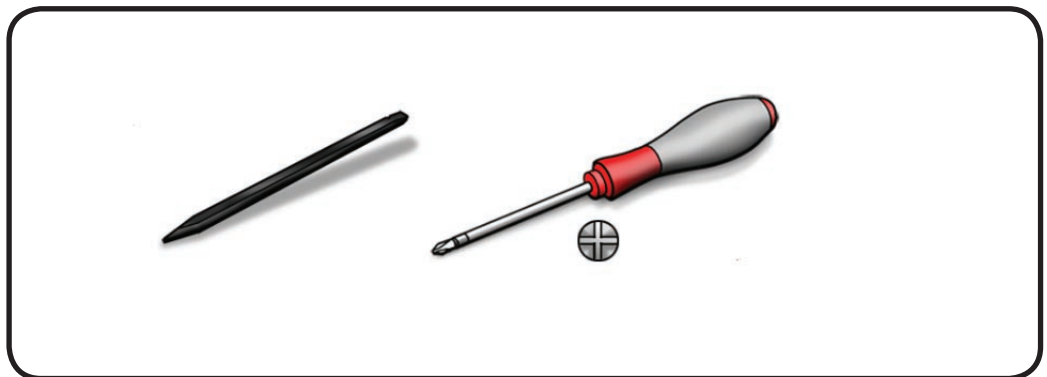



## Removal

- 1 Remove 6 screws; 4 from the carrier and 2 from the interconnect board.

- (4) 922-8822



- (2) 922-8820



- 2 Disconnect the hard drive from the interconnect board. Slide hard drive carrier off the internal frame.

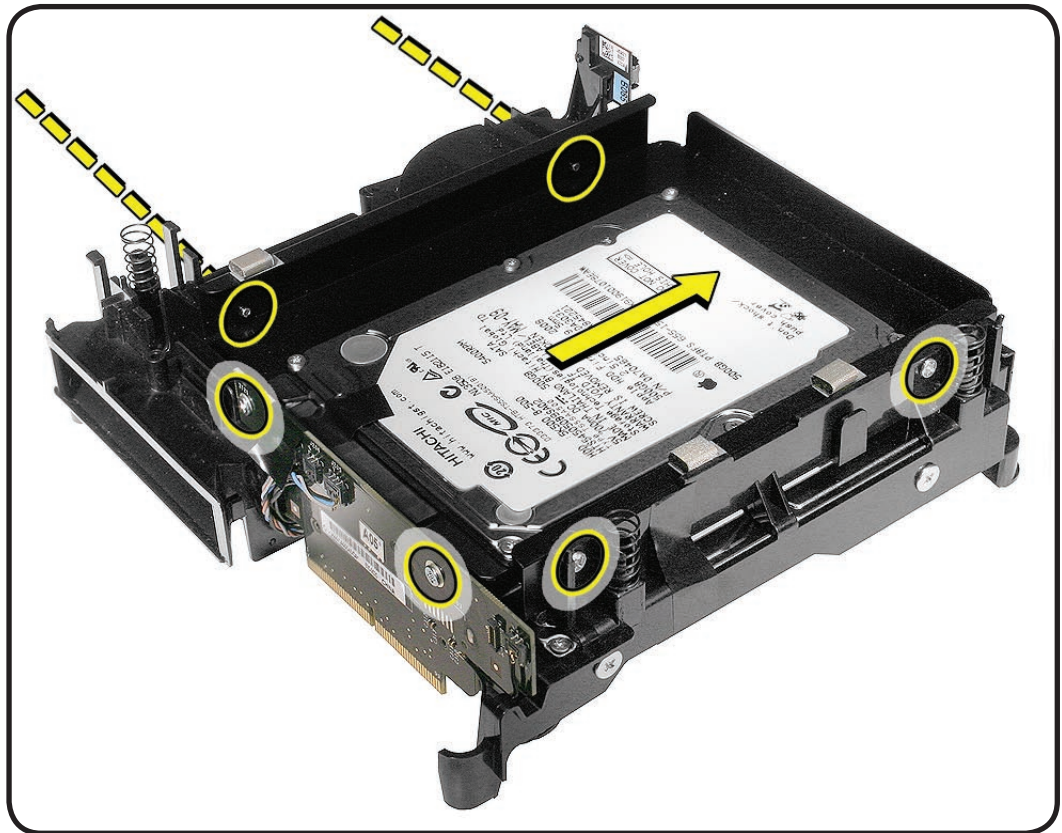

- 3 If you are replacing the carrier, remove 4 carrier screws and transfer hard drive to replacement carrier.

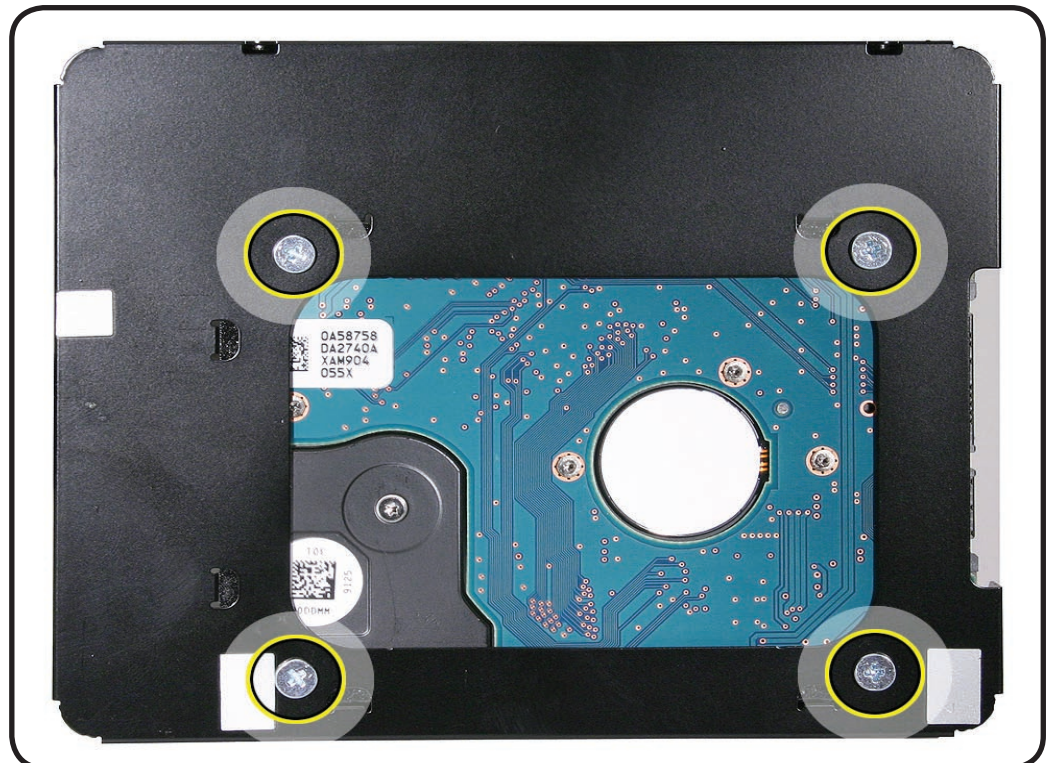



# Hard Drive, Lower

## First Steps

Remove:

- Top housing
- Internal frame

**Note:** On the Mac mini dual hard drive configuration, this drive is known as the “lower” drive.

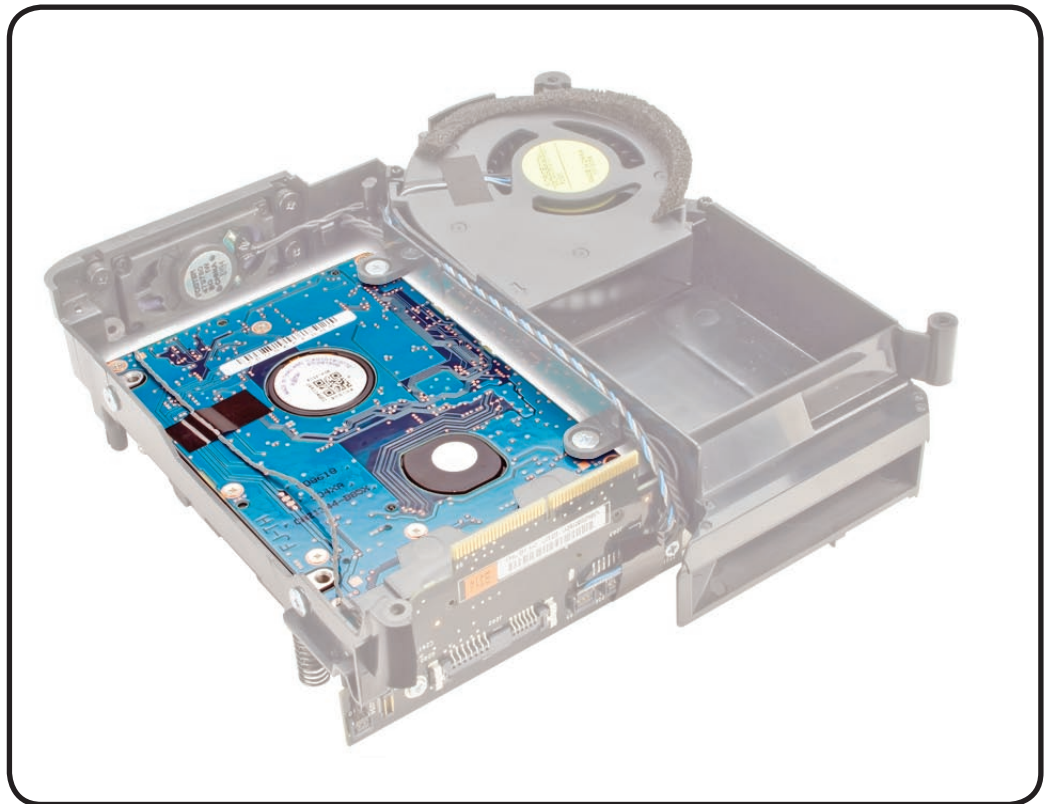

## Tools

- Phillips #1 screwdriver
- Black stick

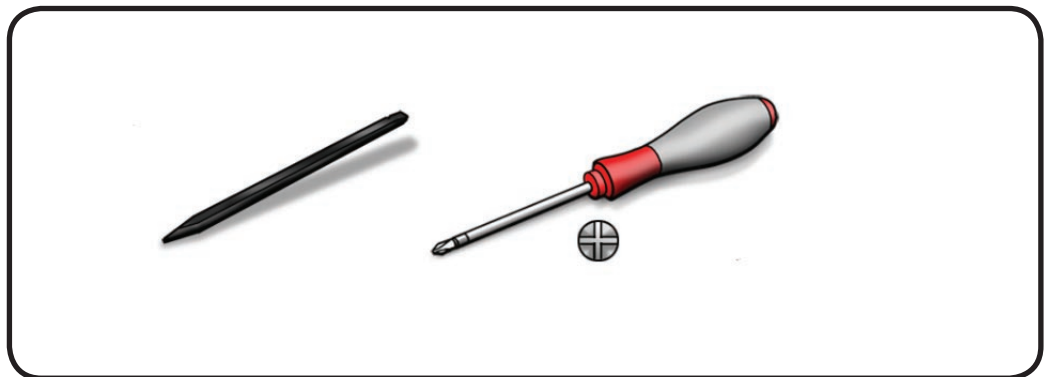



## Removal

- 1 Remove 4 screws 922-8822.

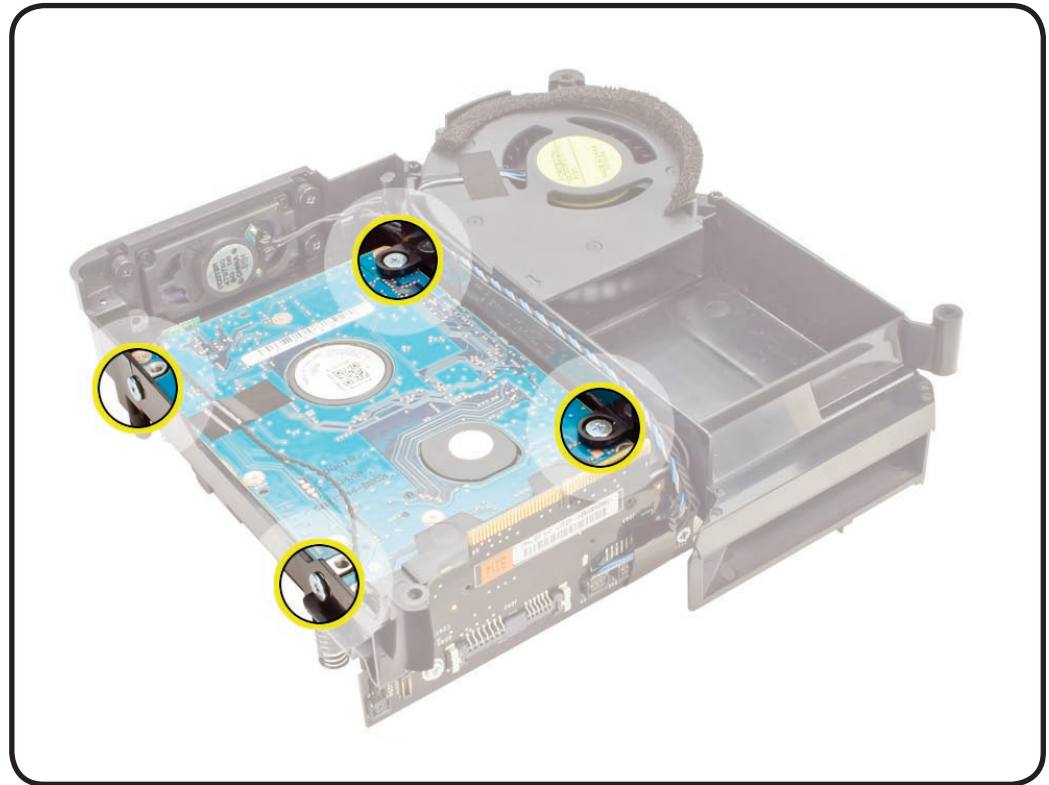

- 2 Disconnect the hard drive sensor cable from J204 on the interconnect board.

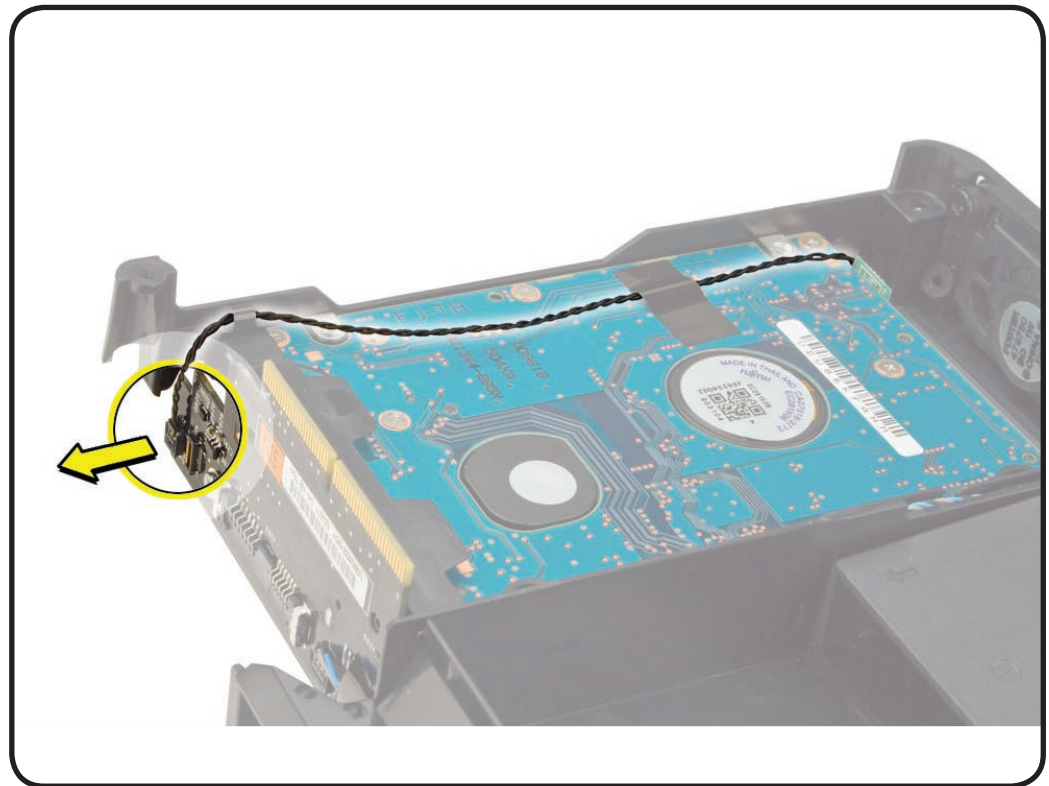



**3** With a black stick, pry hard drive from the interconnect board connector.

**4** Carefully remove the hard drive from the internal frame.

**Note:** The hard drive sensor cable remains with the hard drive.

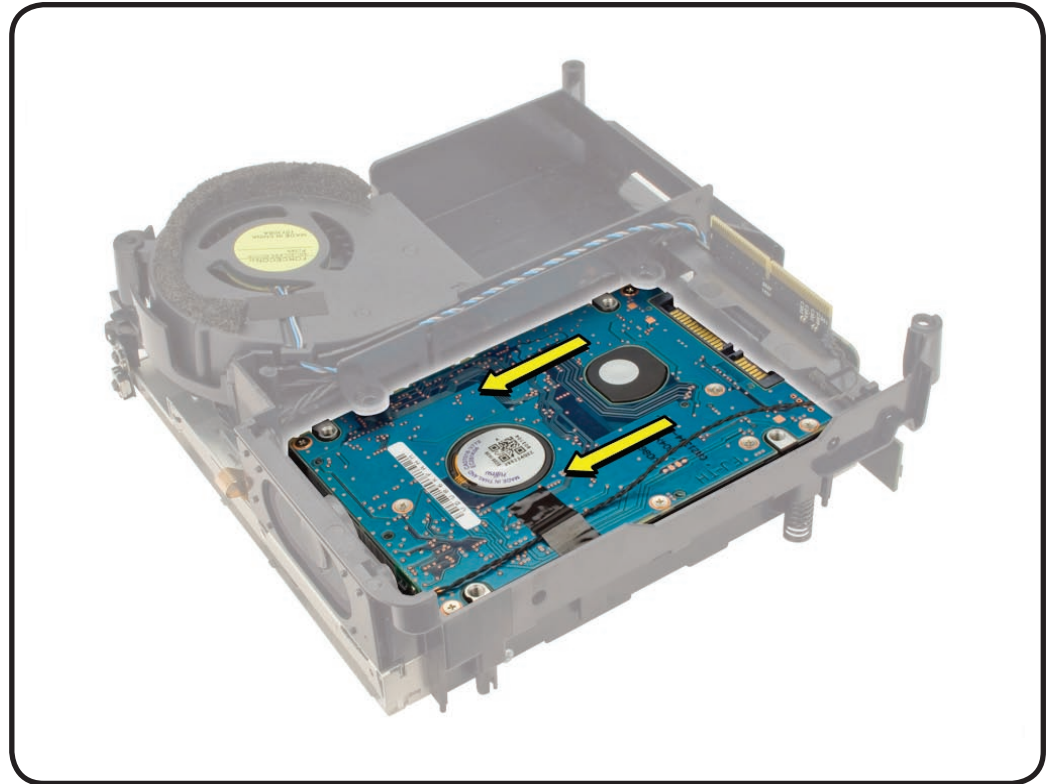



# Hard Drive, Upper (Late 2009)

## First Steps

Remove:

- Top housing
- Internal frame
- Hard drive carrier

**Note:** On the Mac mini dual hard drive configuration, this drive is known as the “upper” drive.

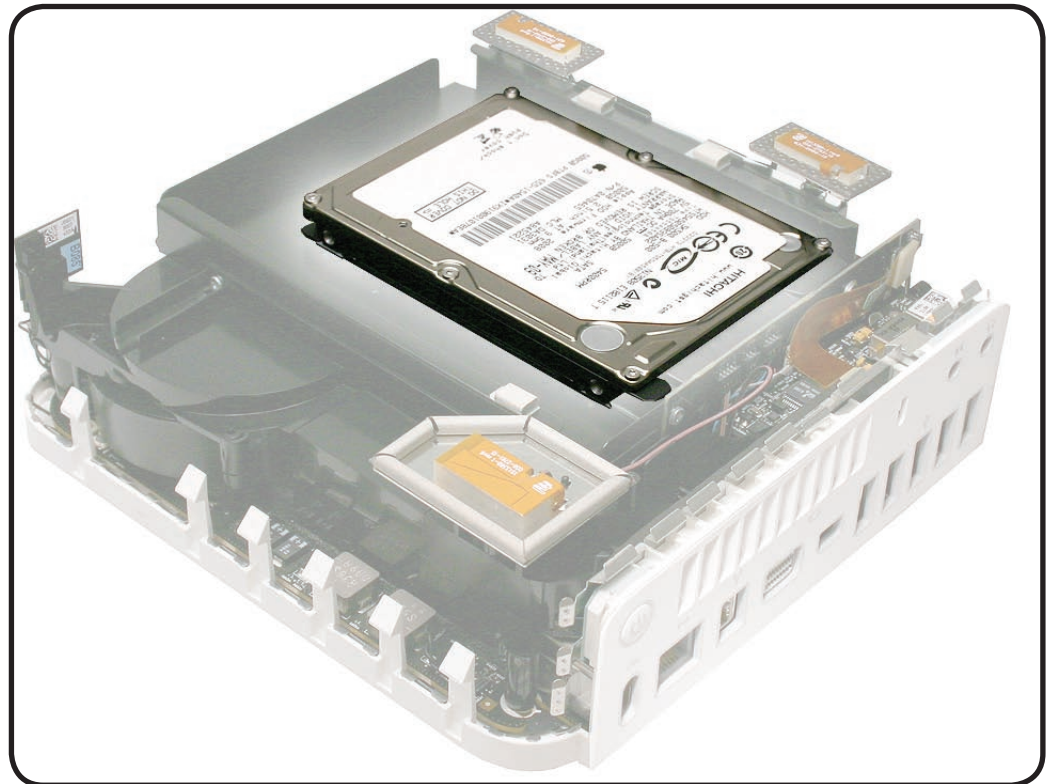

## Tools

- Phillips #0 screwdriver
- Black stick

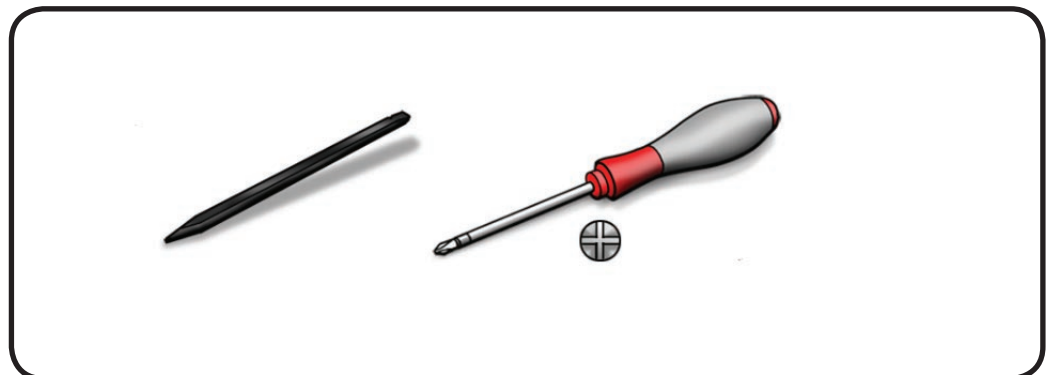



## Removal

- 1 Turn over the hard drive carrier.
- 2 Remove 4 screws:
  - 922-8822.



**Note:** The upper drive does not have a temp sensor cable like the lower hard drive.

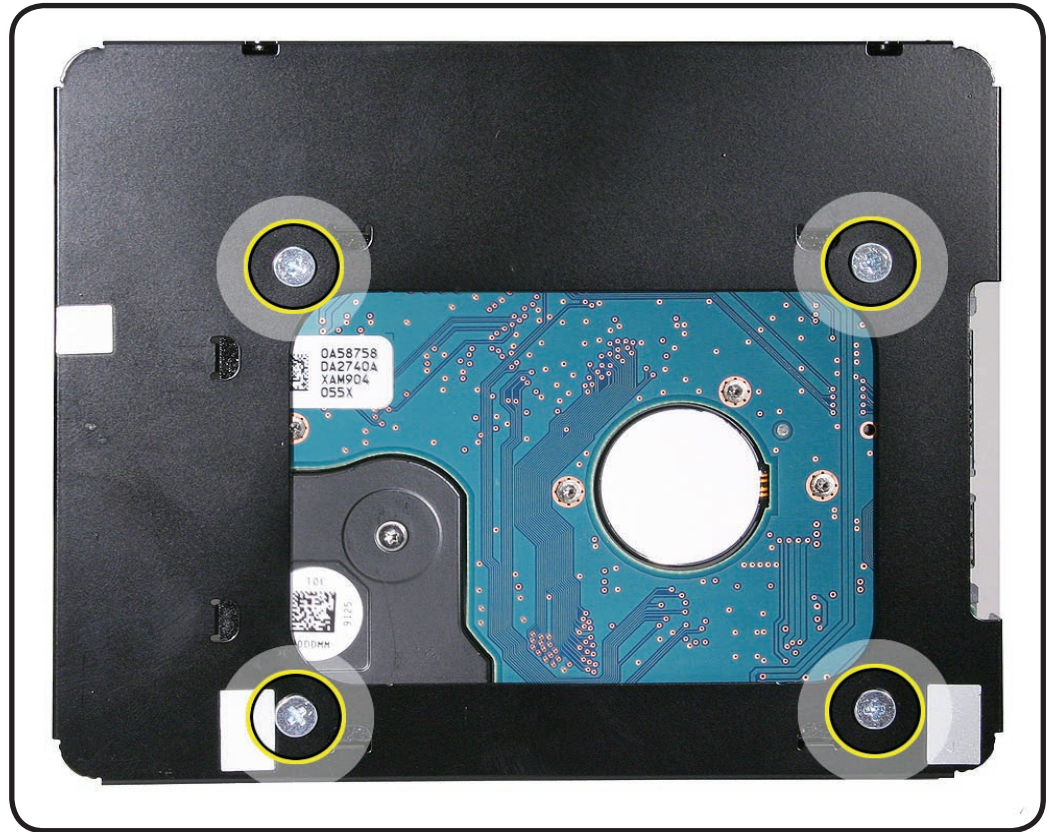

## Reassembly

- 1 Slide hard drive carrier into internal frame.
- 2 Slide hard drive connector into interconnect board connector.
- 3 Replace 6 screws.

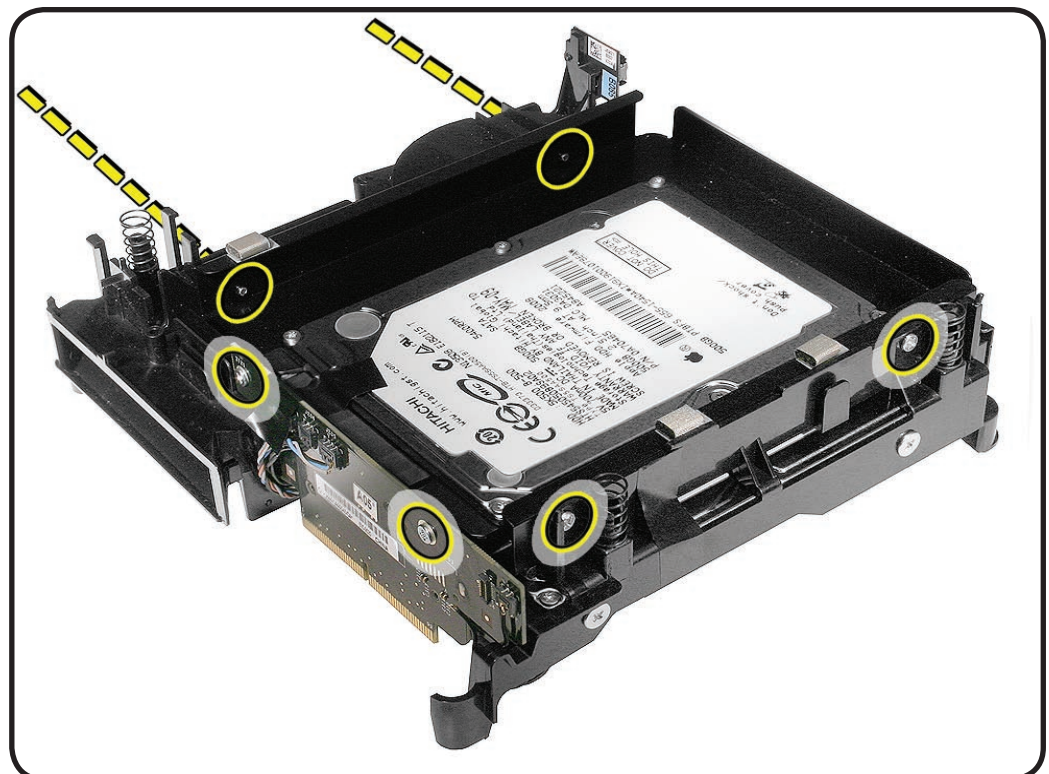





# Optical Drive

## First Steps

Remove:

- Top housing
- Internal frame

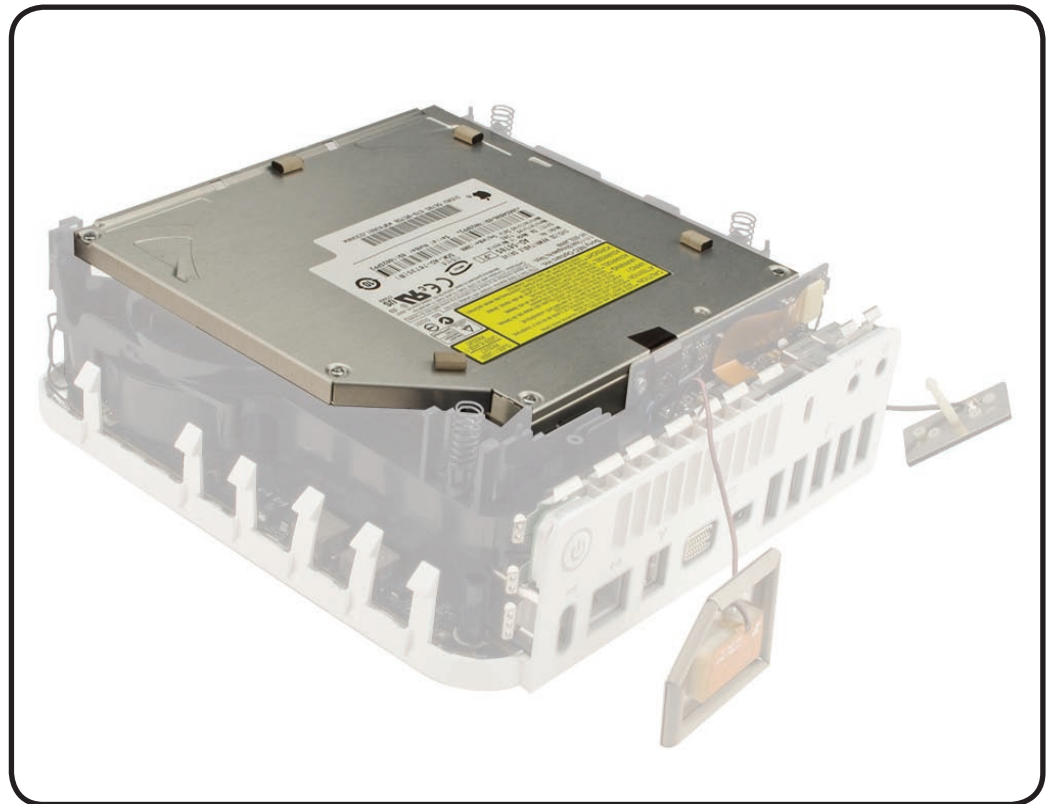

## Tools

- Phillips #0 screwdriver
- Black stick

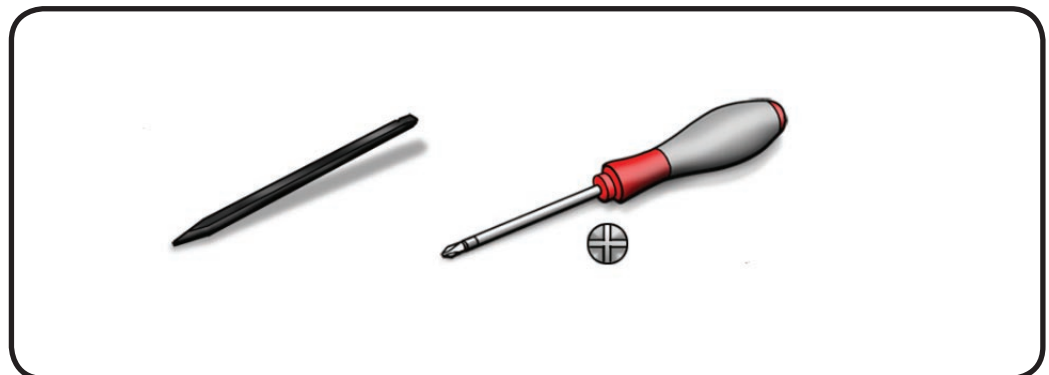



## Removal

- 1 Remove 2 screws 922-6680.

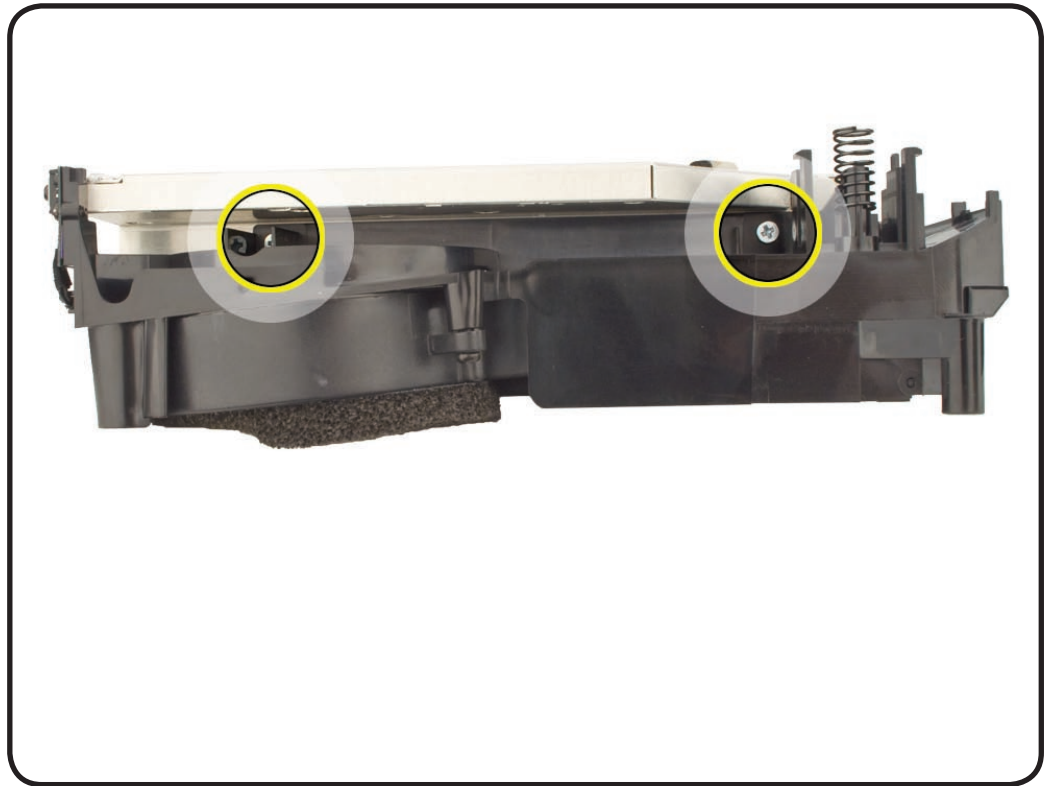

- 2 Rotate the internal frame 180 degrees. Remove 2 more screws 922-6680.

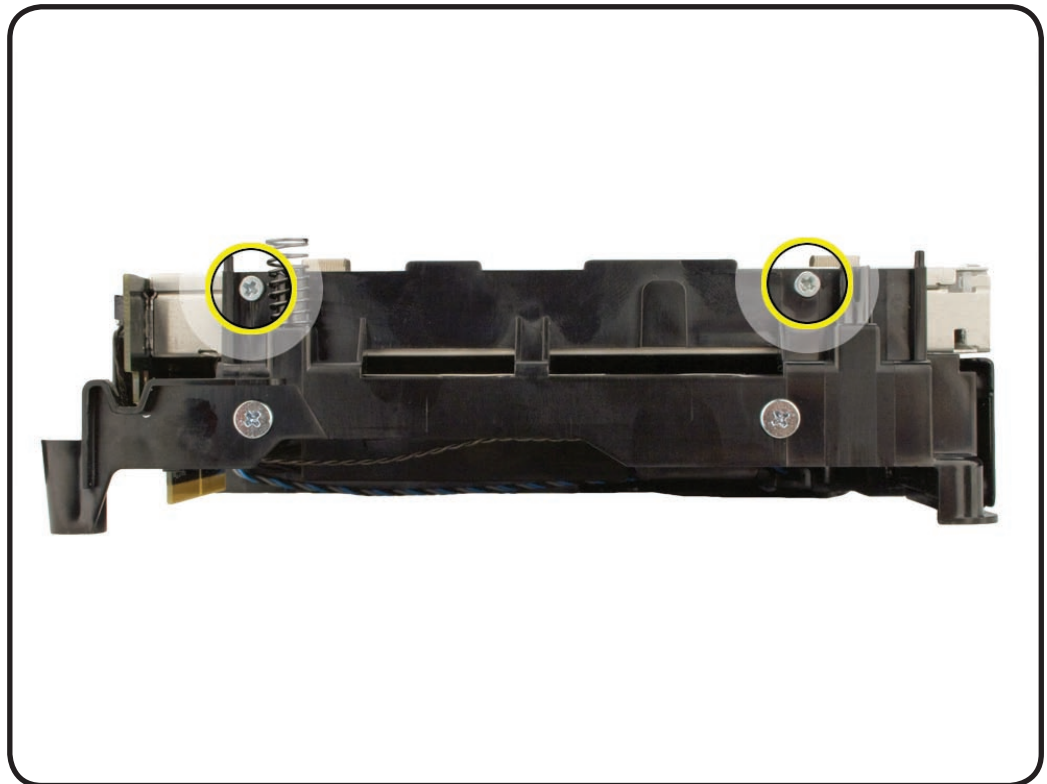



- 3 Rotate the internal frame so the interconnect board is facing you. Remove 2 interconnect board screws 922-6680.



- 4 Remove the black tape attaching from the interconnect to the optical drive.
- 5 Use a black stick to pry the optical drive from the interconnect board connector.





# Fan

## First Steps

Remove:

- Top housing
- Internal frame

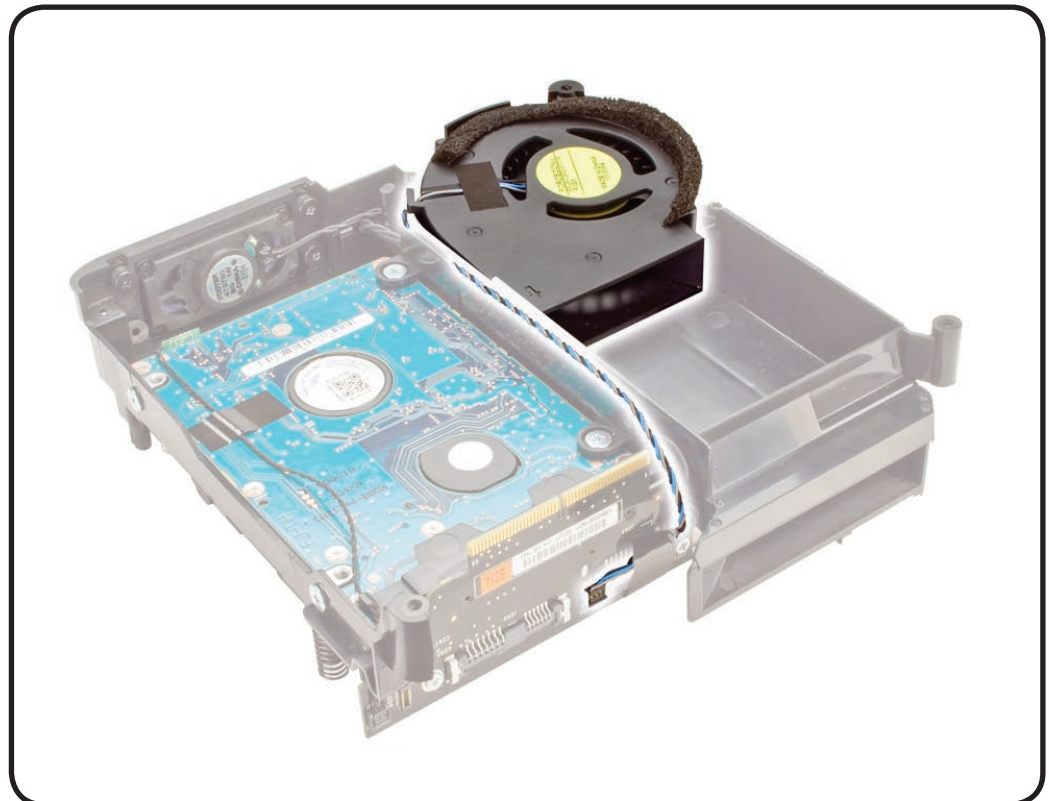

## Tools

- Phillips #0 screwdriver
- Black stick

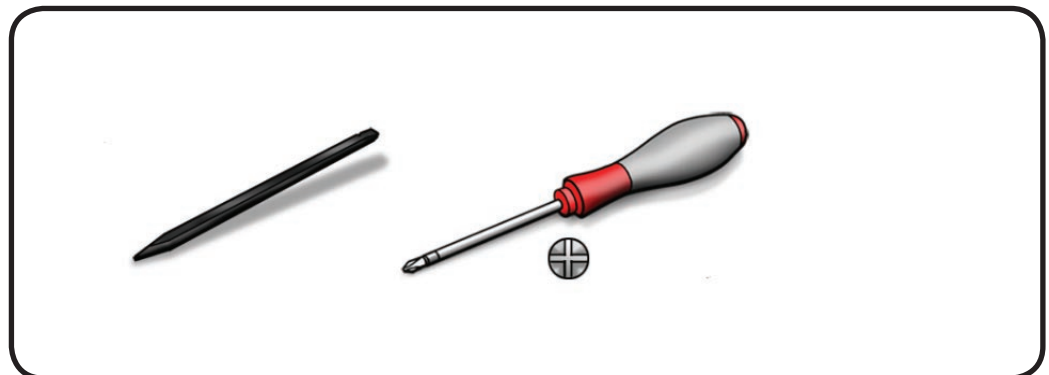



## Removal

- 1 Remove 2 fan screws 922-8819.

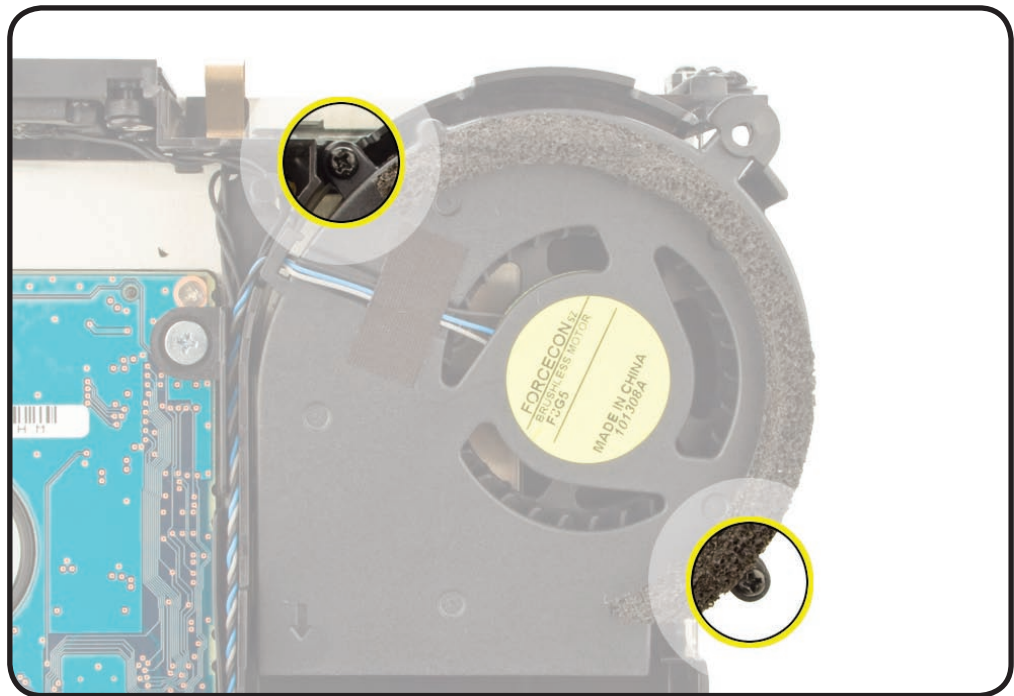

- 2 Free fan tab from the corner of the internal frame.

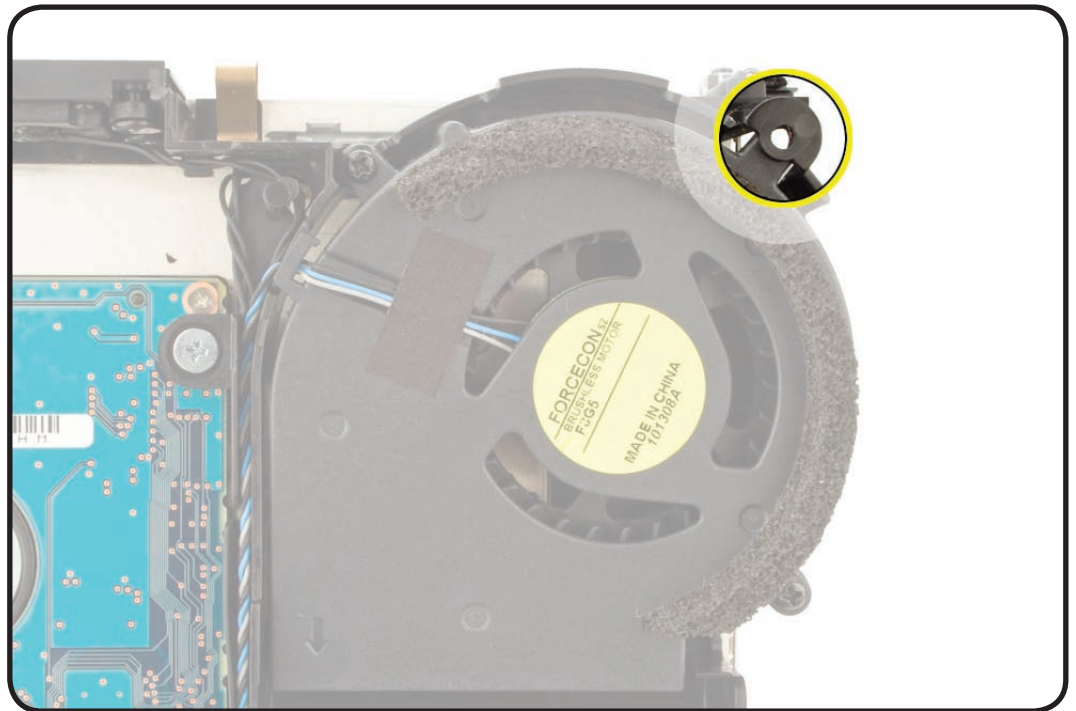



**3** Remove the fan cable from the cable channel.

**4** Disconnect the twisted (black, blue and gray) fan cable from connector J205 on the interconnect board.

**Replacement**

**Note:** Make sure to connect the fan. If the fan connector is disconnected, the computer will quickly flash the LED and then shut down.

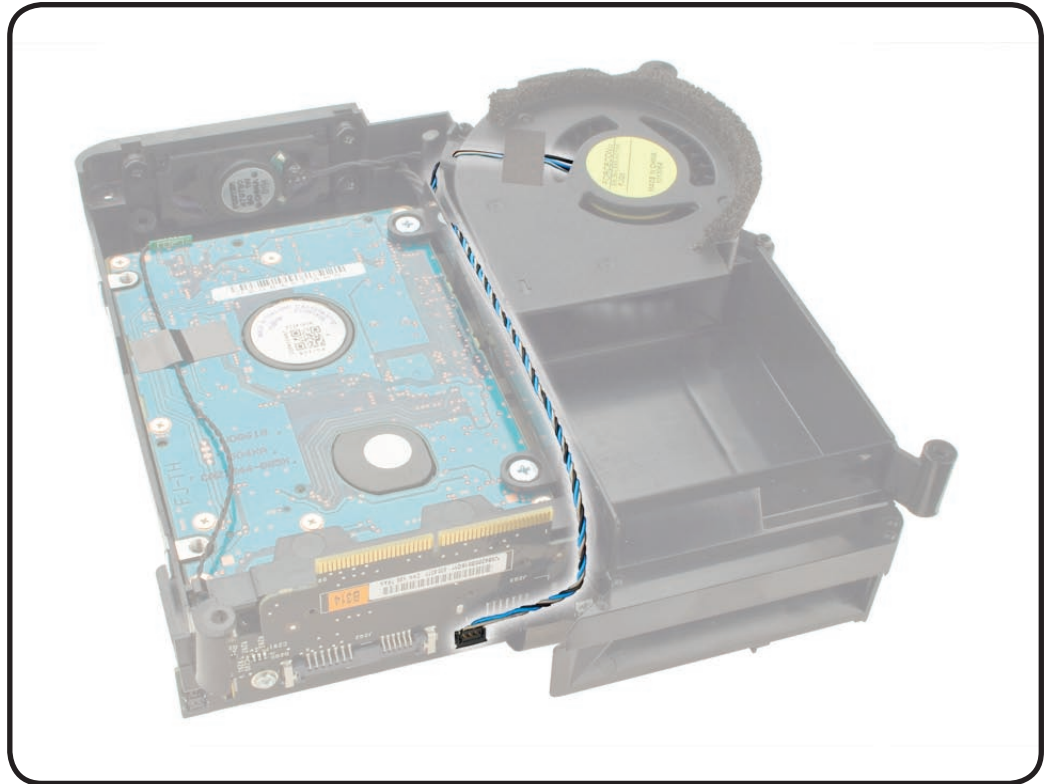



# Interconnect Board

## First Steps

Remove:

- Top housing
- Internal frame

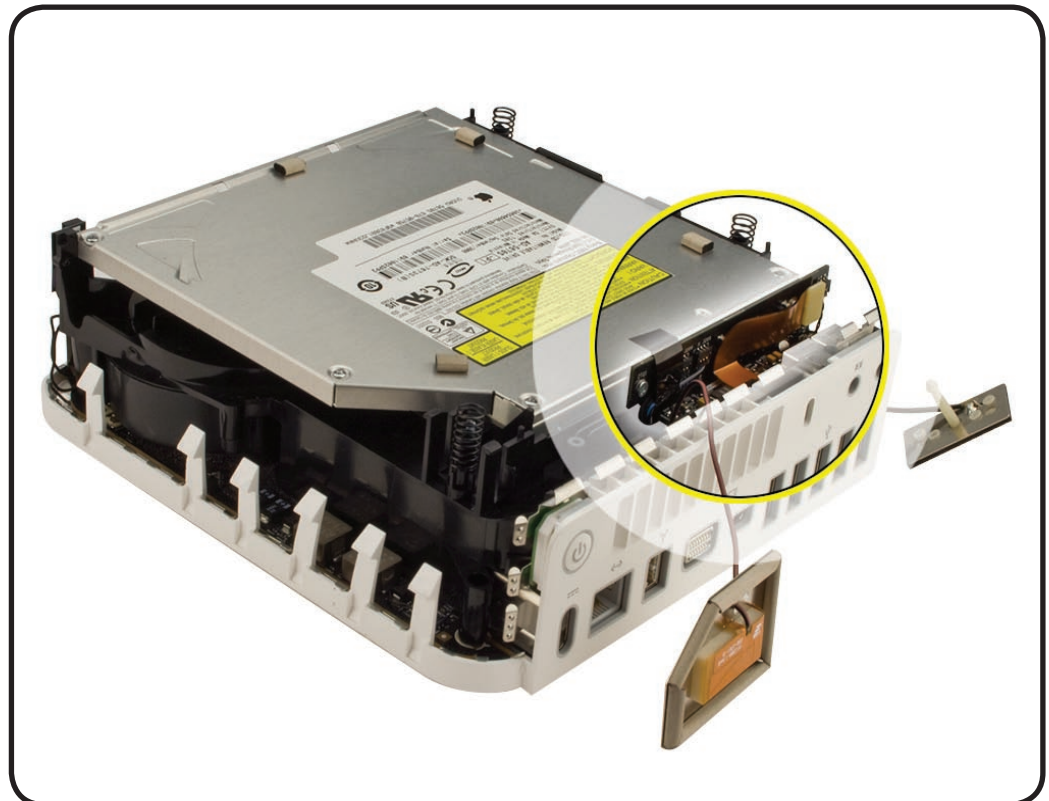

## Tools

- Phillips #0 screwdriver
- Black stick

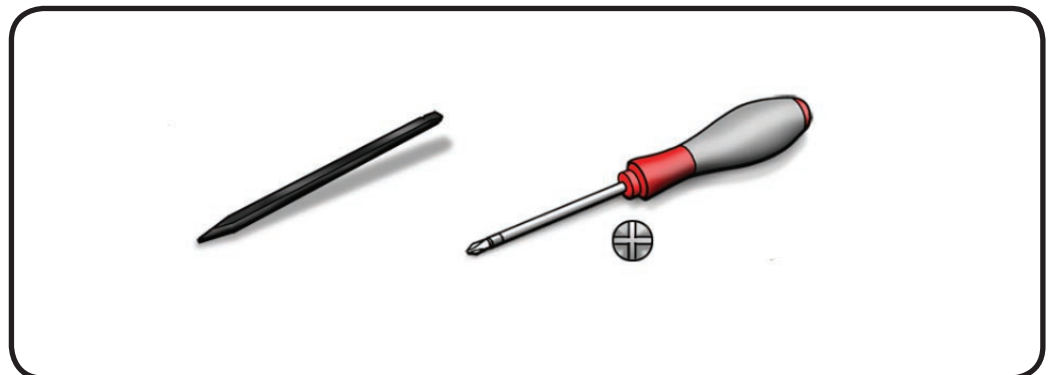



## Removal

- 1 Remove the black tape (not shown) covering the 3 connectors.
- 2 Disconnect 4 cables:
  - IR (J211)
  - speaker (J206)
  - fan (J205)
  - hard drive sensor (J204)



- 3 Using Phillips #0 screwdriver, remove 2 screws 922-8820.



- 4 Pry the interconnect board from the connectors on the optical and hard drive.







# Interconnect Board (Late 2009)

## First Steps

Remove:

- Top housing
- Internal frame

**Note:** This interconnect board is used with the dual hard drive configuration only.

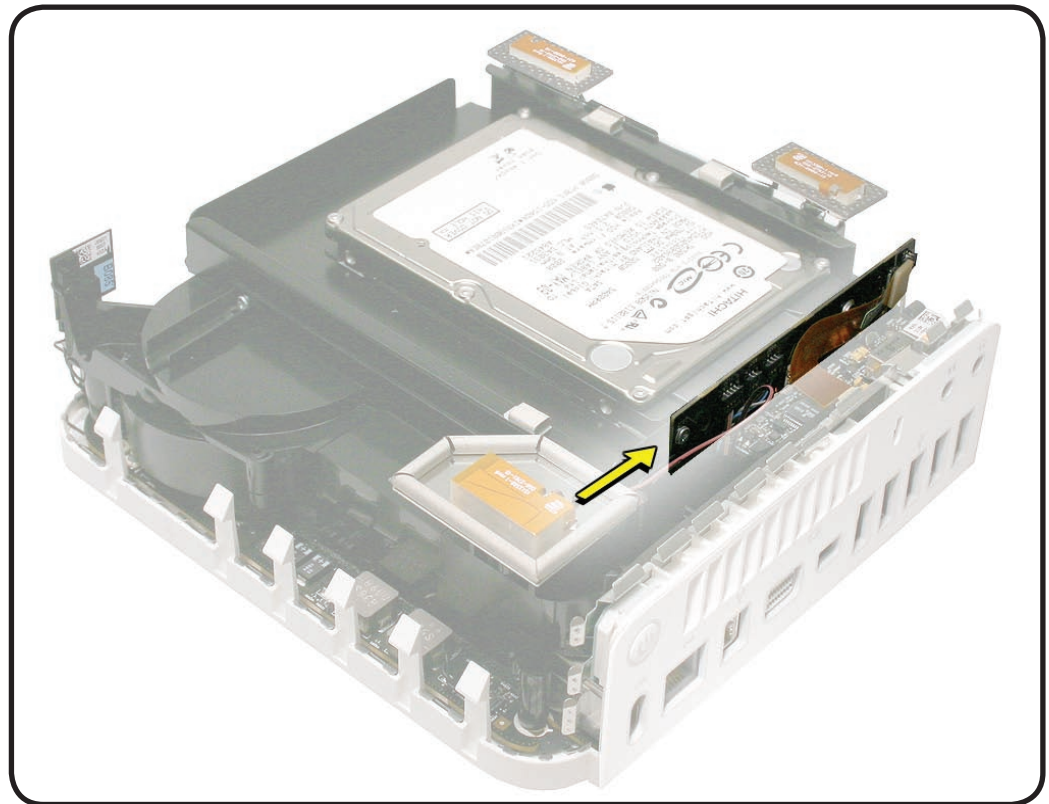

## Tools

- Phillips #0 screwdriver
- Black stick

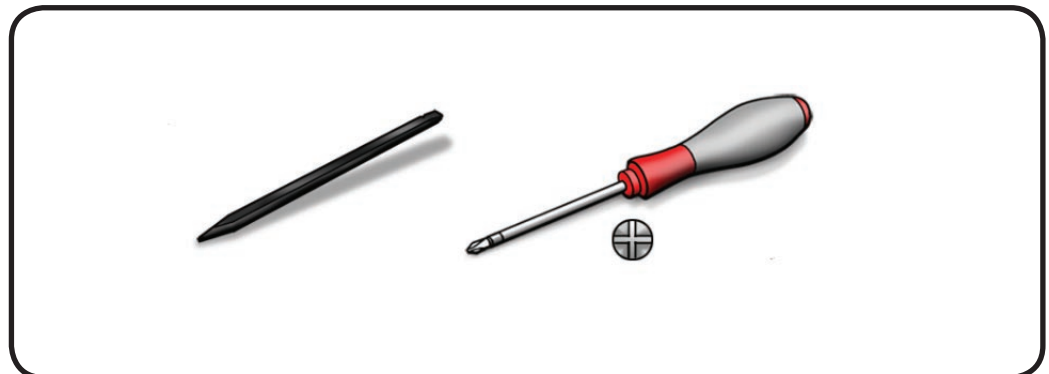



## Removal

- 1 Remove black mylar tape covering the connectors.
- 2 Disconnect 4 cables:
  - IR (J211)
  - speaker (J206)
  - fan (J205)
  - hard drive sensor (J204)

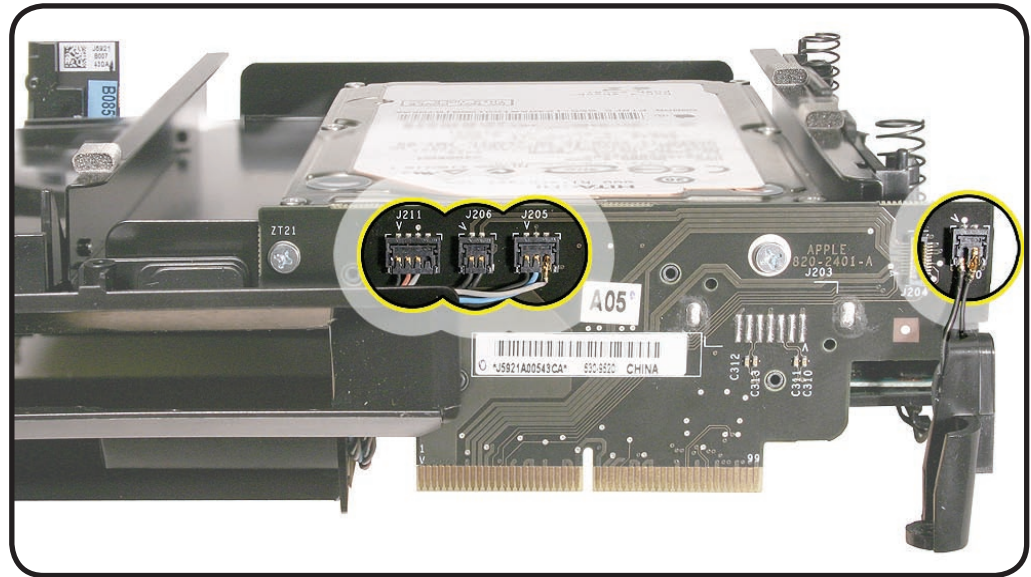

- 3 Remove 2 Phillips #0 screws 922-8820.



4. Pry the interconnect board from the connectors on the 2 hard drives.

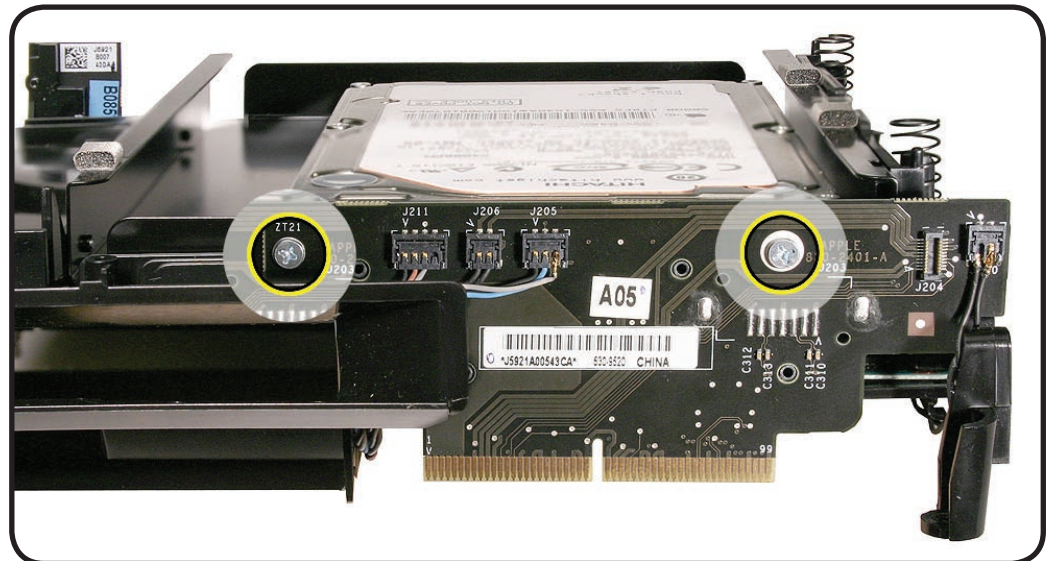



# Battery

## First Steps

Remove:

- Top housing
- Internal frame

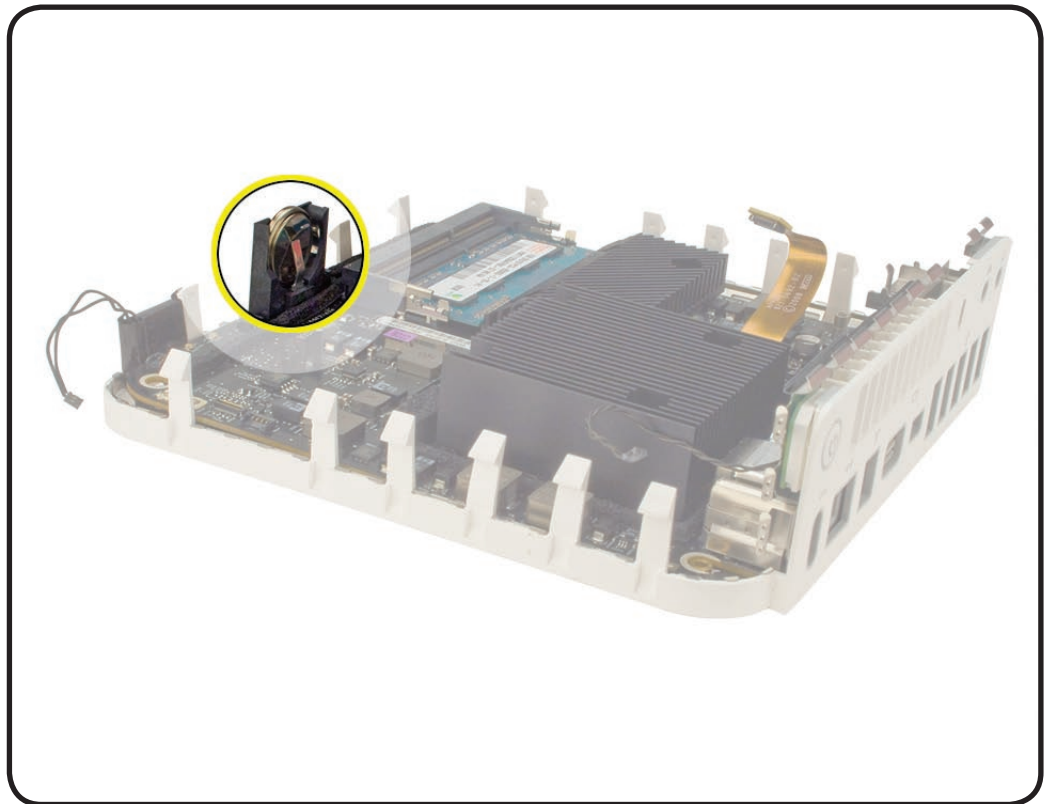

## Tools

- Black stick





## Removal

- 1 Using your finger or black stick, push the battery inward.
- 2 Grab the battery as it slips up and out of the battery holder.

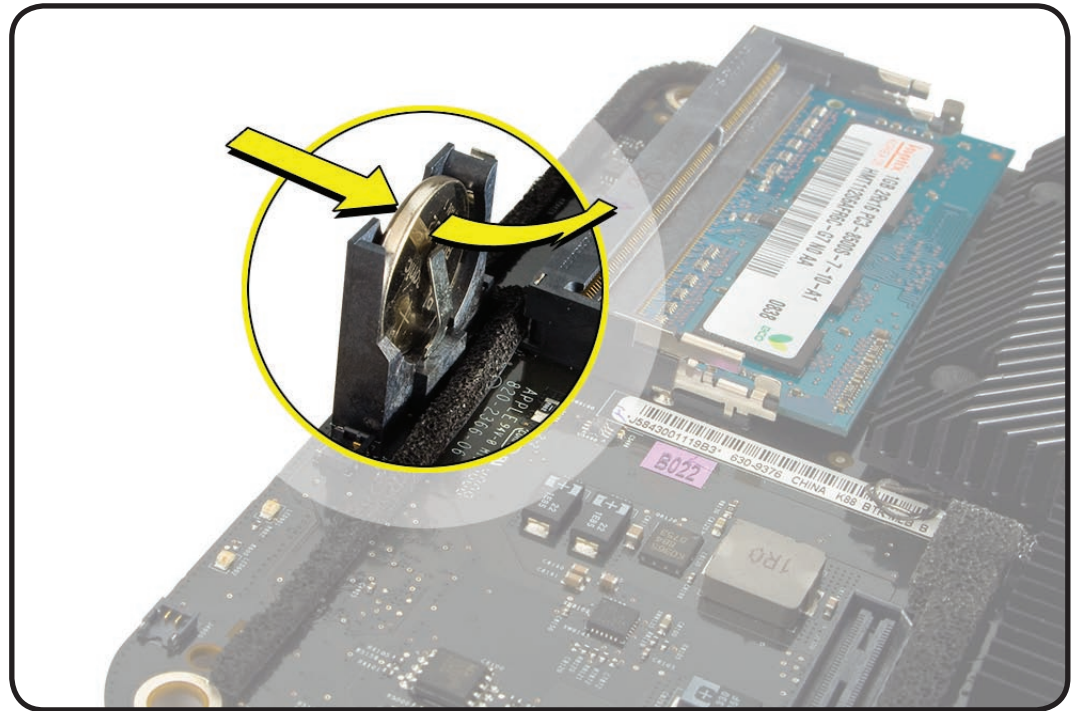



# Speaker

## First Steps

Remove:

- Top housing
- Internal frame

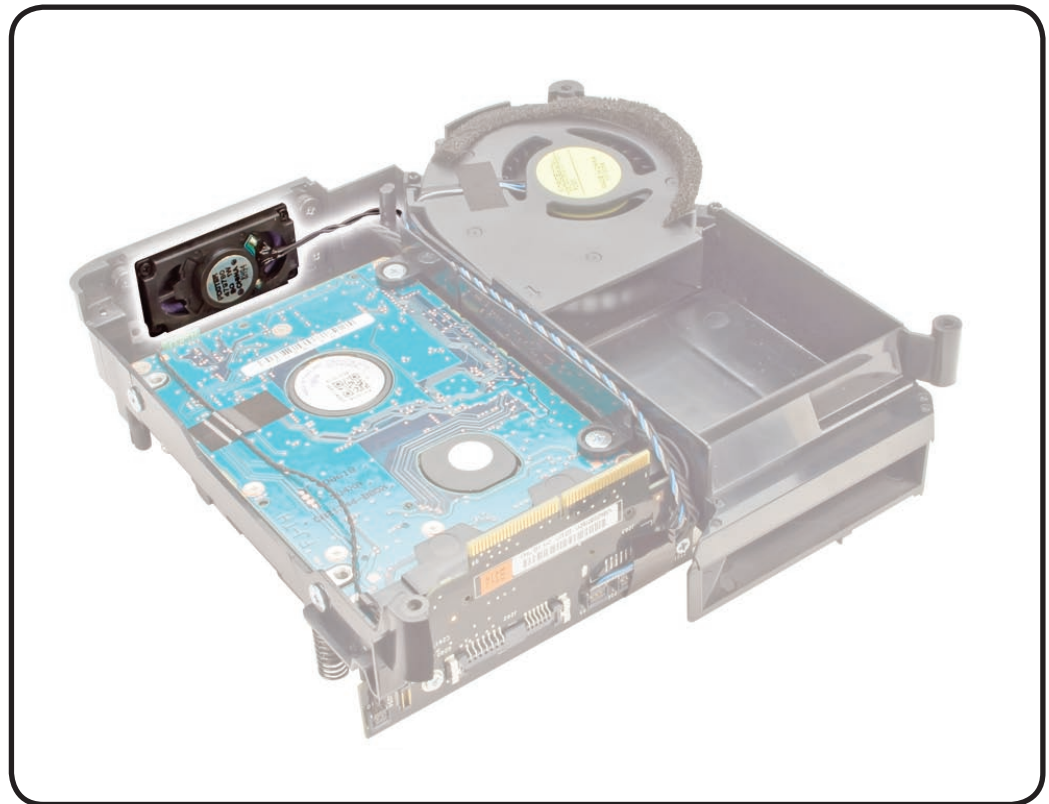

## Tools

- Phillips #0 screwdriver
- Black stick

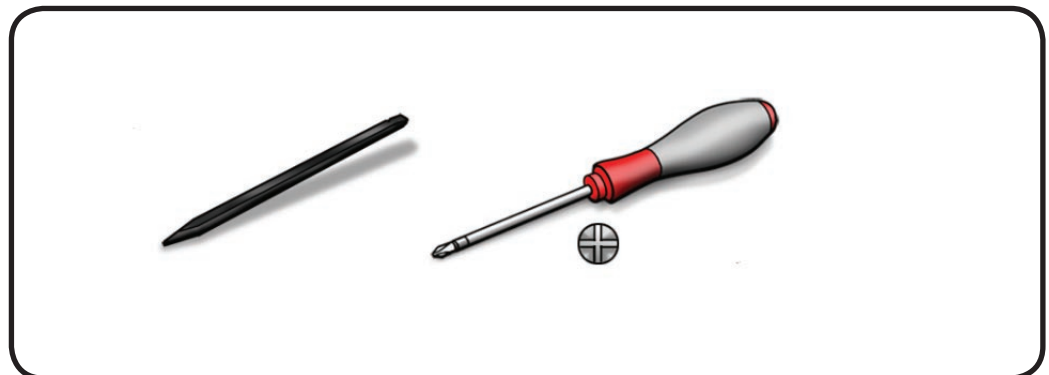



## Removal

1. Remove 4 shoulder screws 922-6925.



**Replacement Note:**  
It's easier to replace the 2 lower speaker screws when the hard drive is removed.

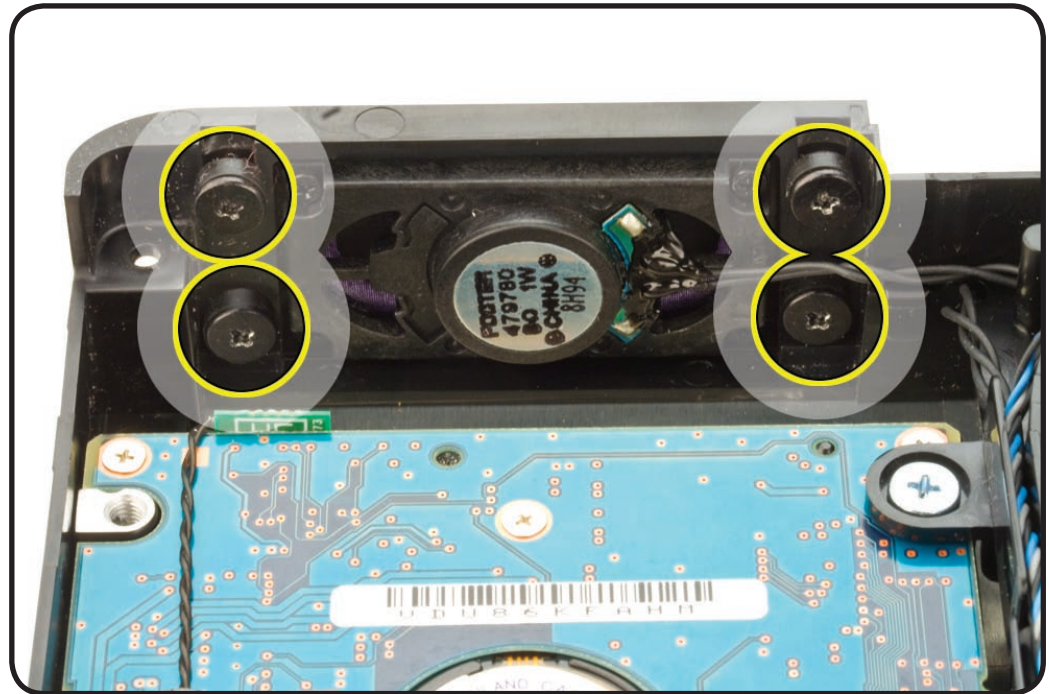

2. Free the speaker cable from the cable clip on the internal frame.

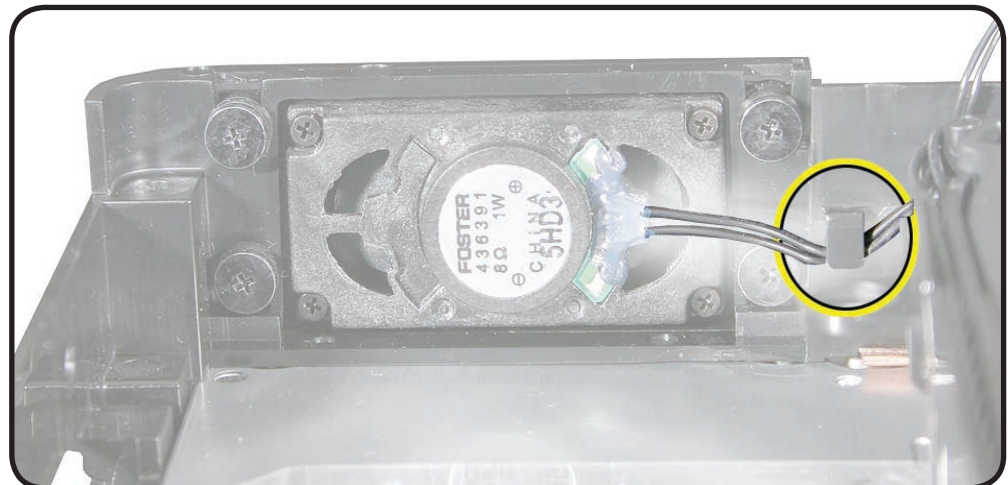



- 3** Remove speaker cable from the cable channel.
- 4** Disconnect the 2-pin speaker cable from J206 on interconnect board.

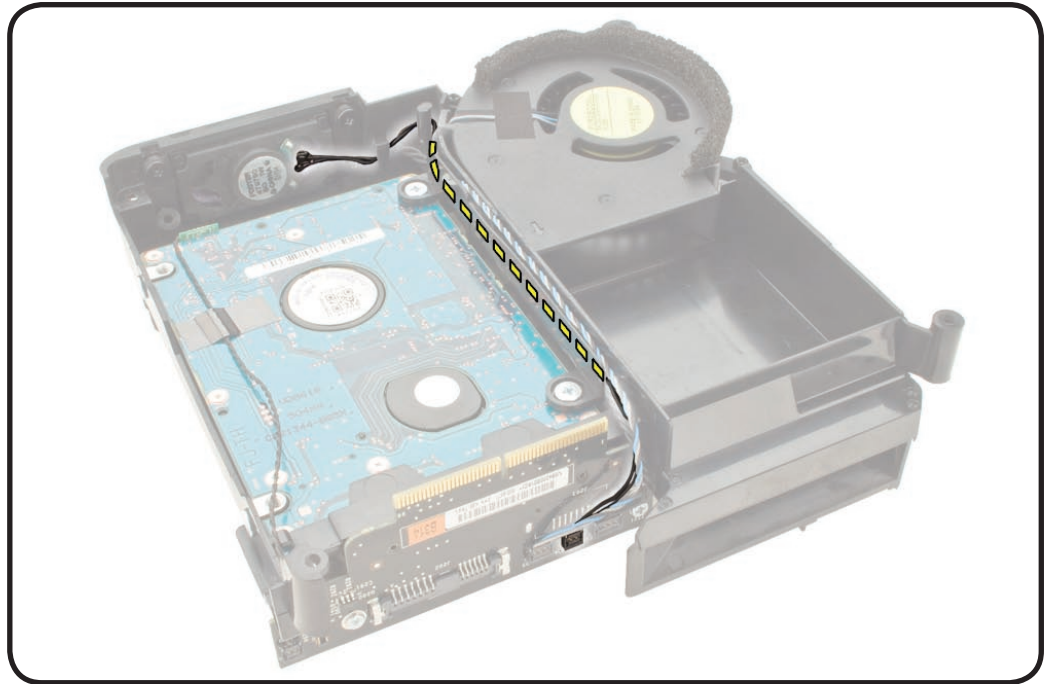



# Logic Board

## First Steps

Remove:

- Top housing
- Internal frame

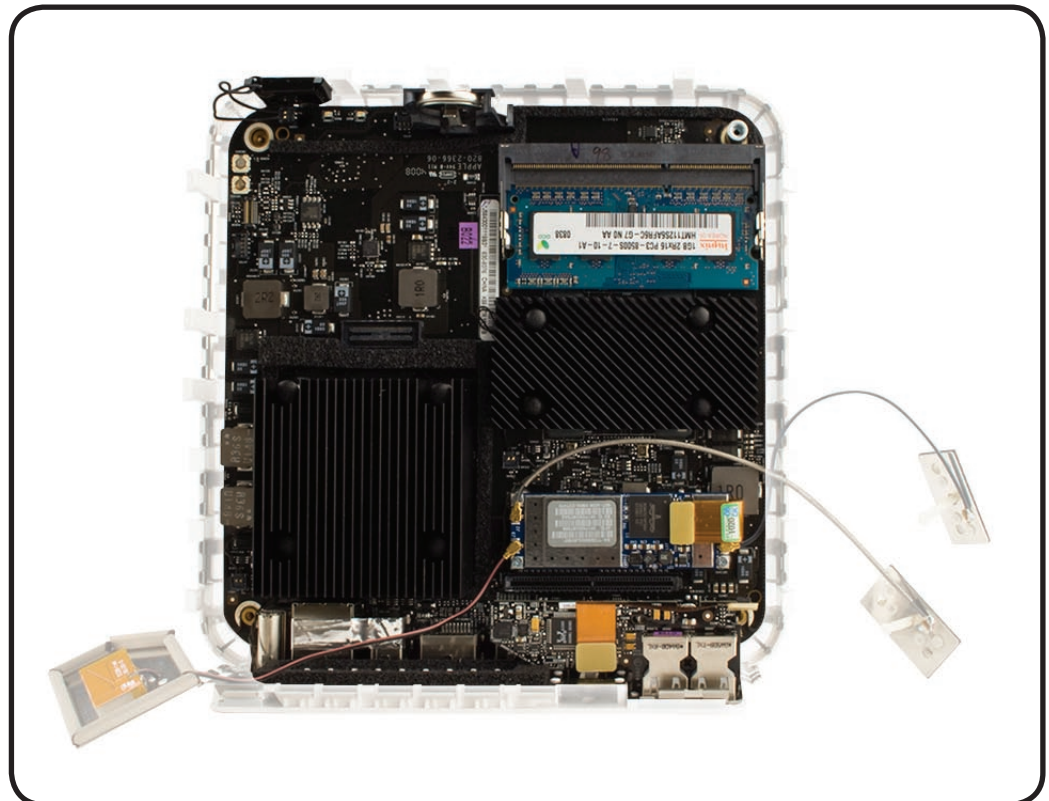

## Tools

- Torx T10 screwdriver
- Black stick

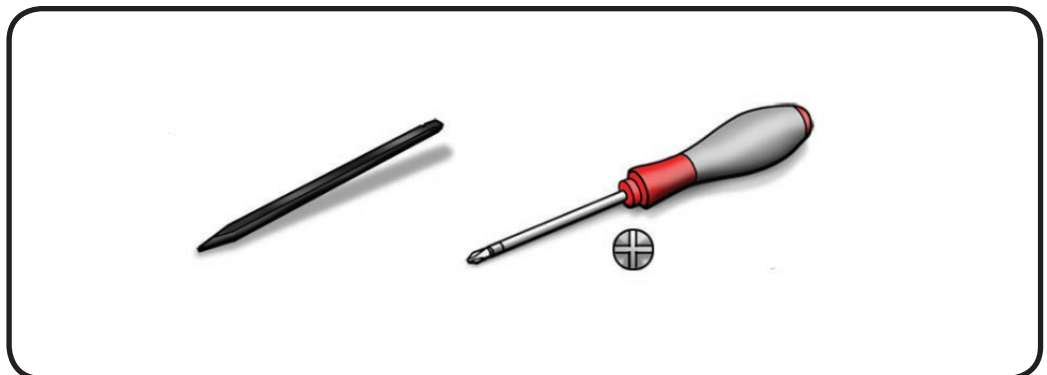





## Removal

- 1 With a black stick, carefully disconnect the power button cable. Lift the cable vertically.

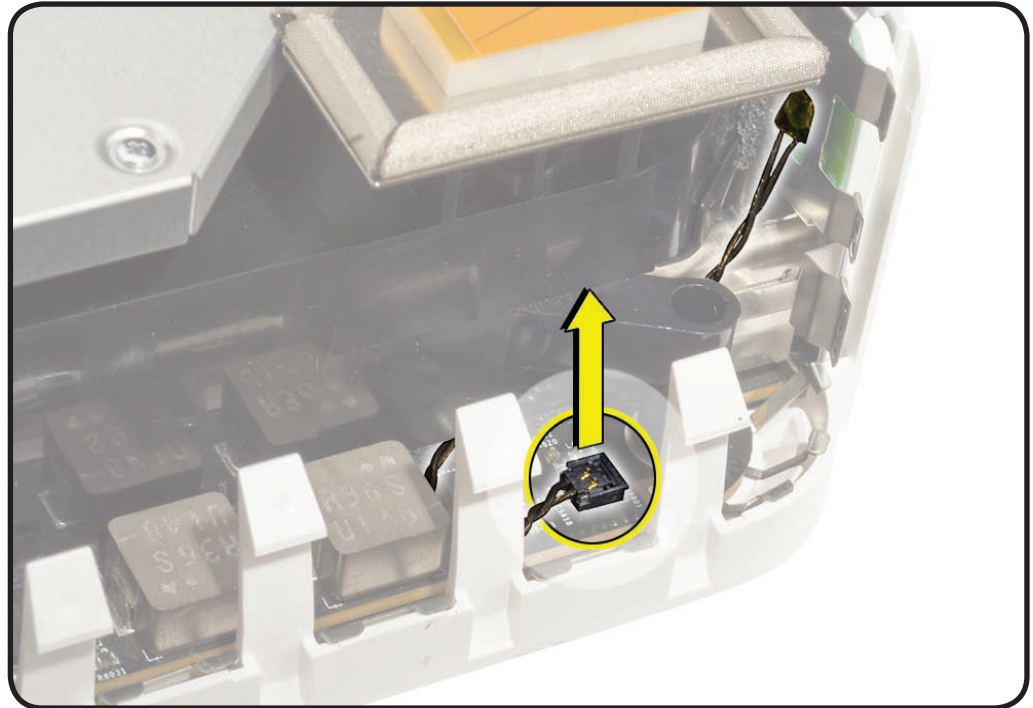

- 2 With a black stick, carefully disconnect the power-on LED. Lift the cable vertically.

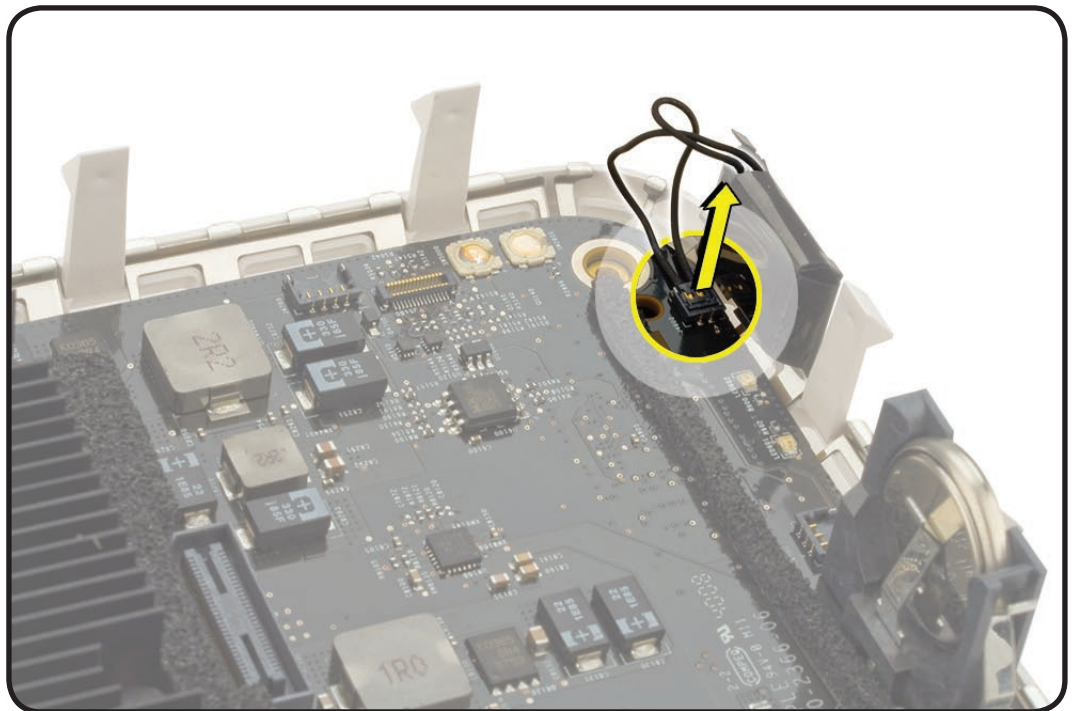



- 3** Near the memory slot, use a T10 screwdriver to remove the standoff 922-7434.

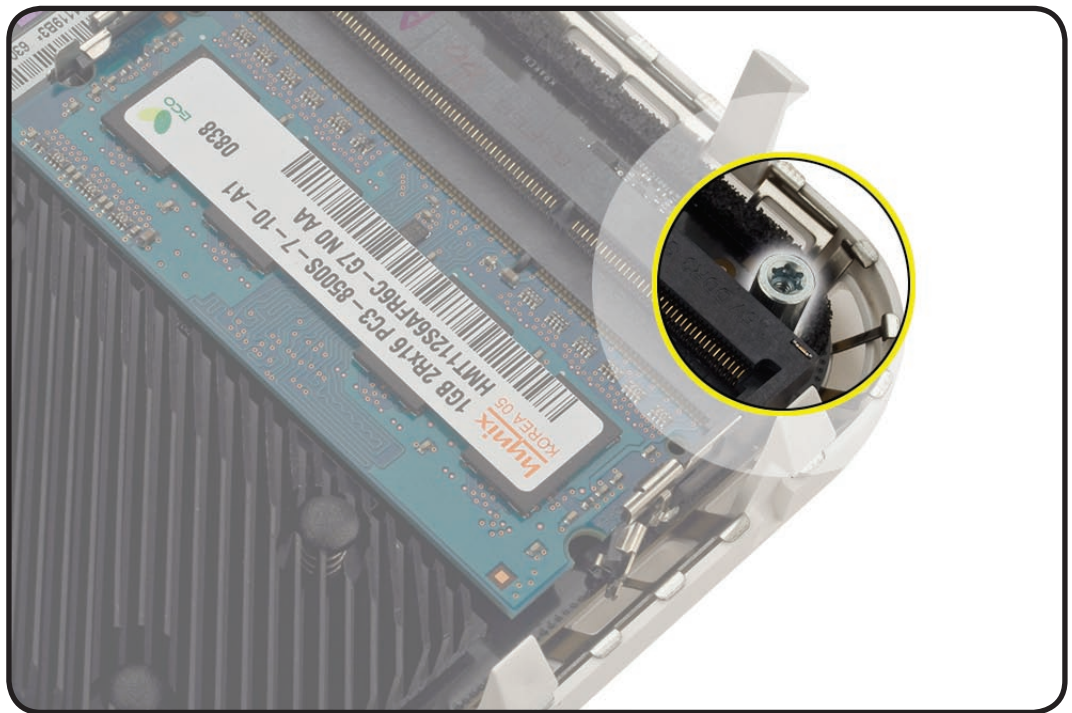

- 4** With a black stick, pry up the logic board. As you lift the logic gently tilt the power-on LED out of the way.

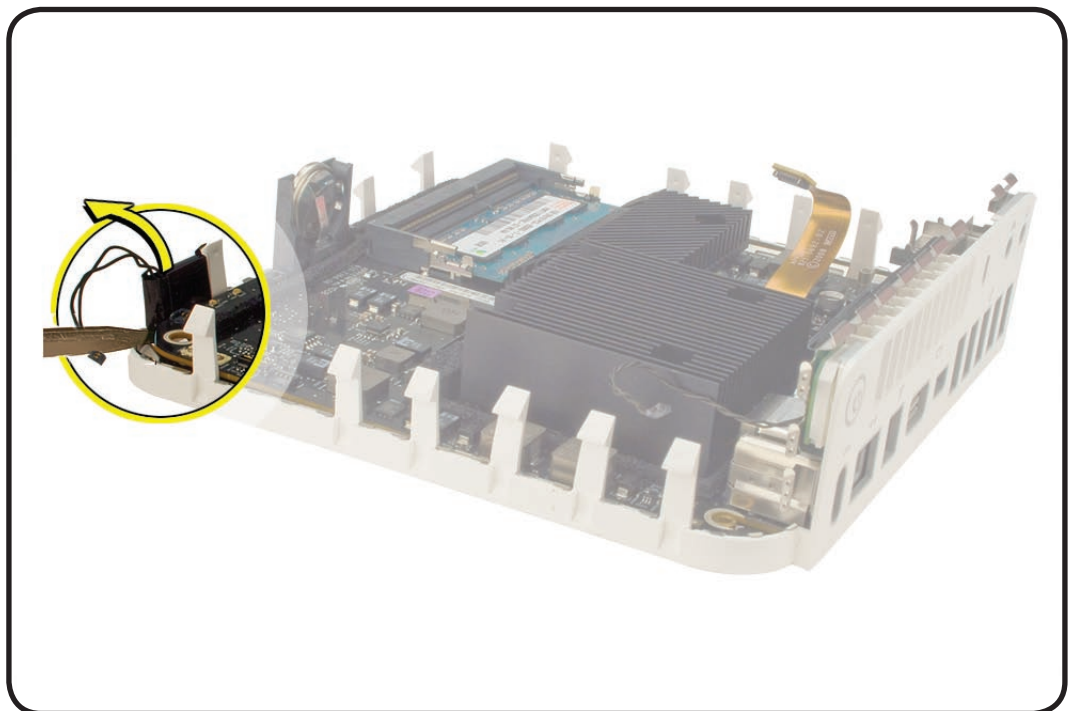



- 5 Slide the board out of the I/O ports.

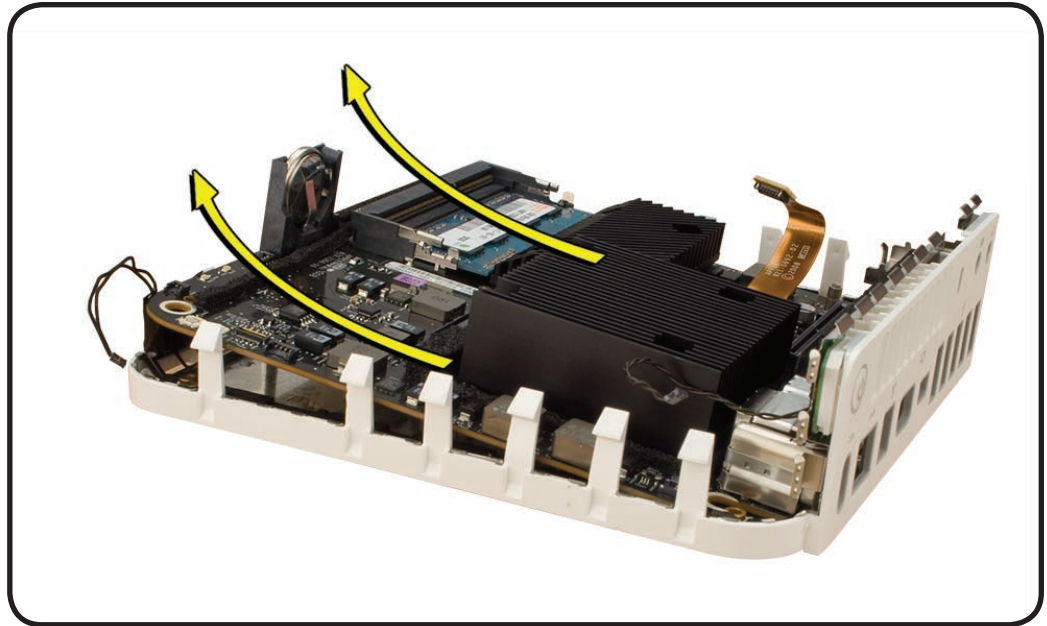

**Important:** Be careful not to damage the EMI clips on the underside of the board.

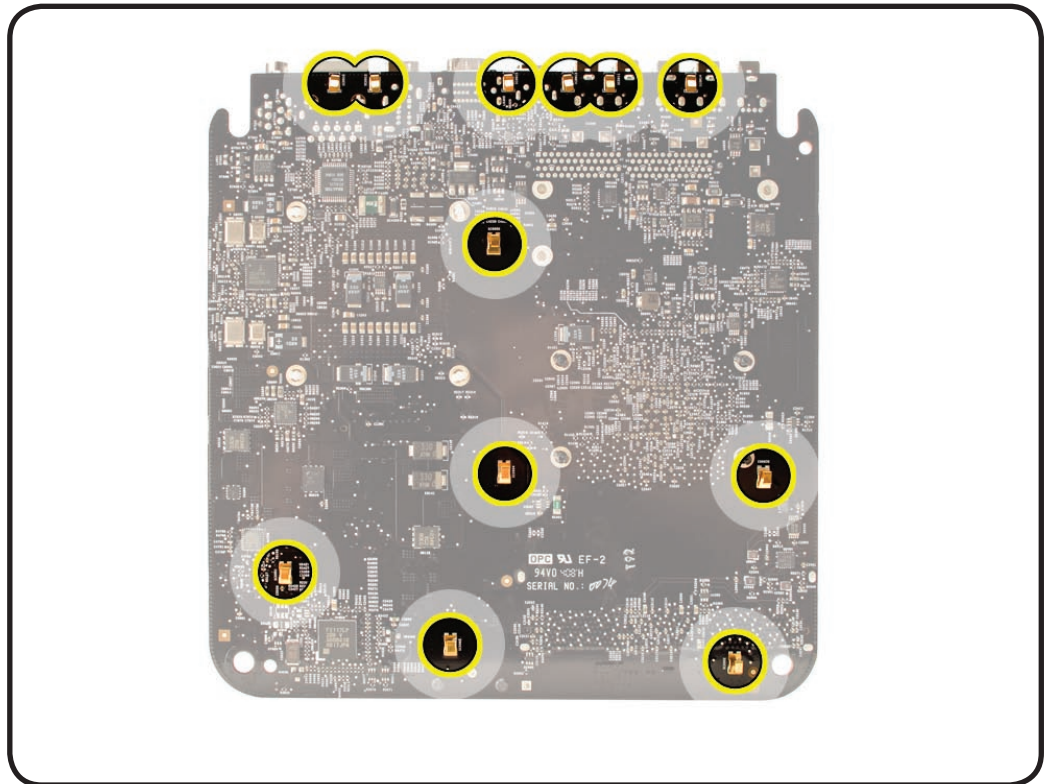



- 6** To protect the EMI clips, **always place the board on the pink antistatic foam** when the board is not in a system.

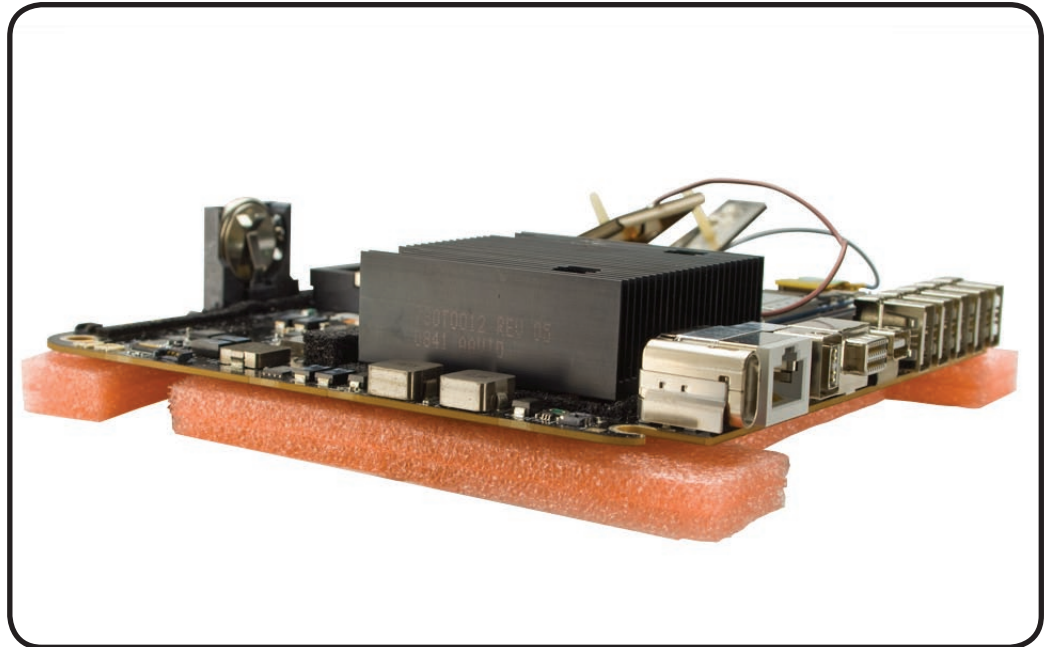

## Reassembly

- 1** Before returning the board to Apple, remove:
- memory DIMMs
  - AirPort/Bluetooth combo card
  - AirPort/Bluetooth flexible cable
- 2** **Important:** Return the logic board to Apple with the antistatic foam placed on the underside of the board to protect the EMI clips.

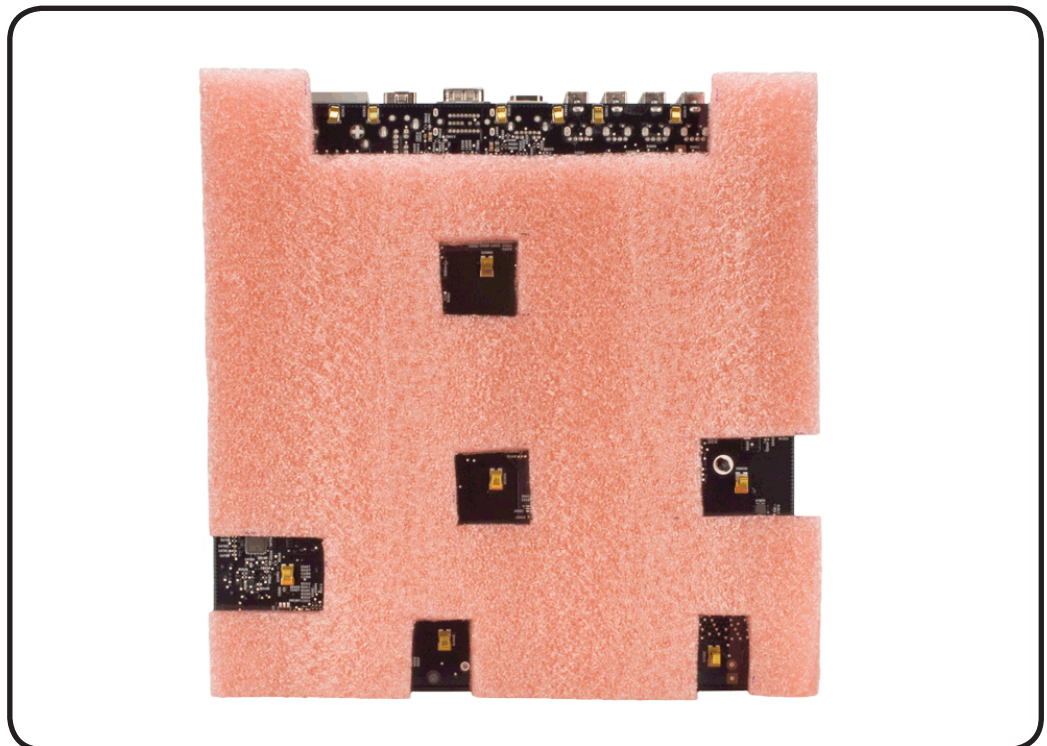



# Bottom Housing

## First Steps

- Top housing
- Internal frame
- Audio board
- Logic Board

## Tools

No tools are required for this procedure.

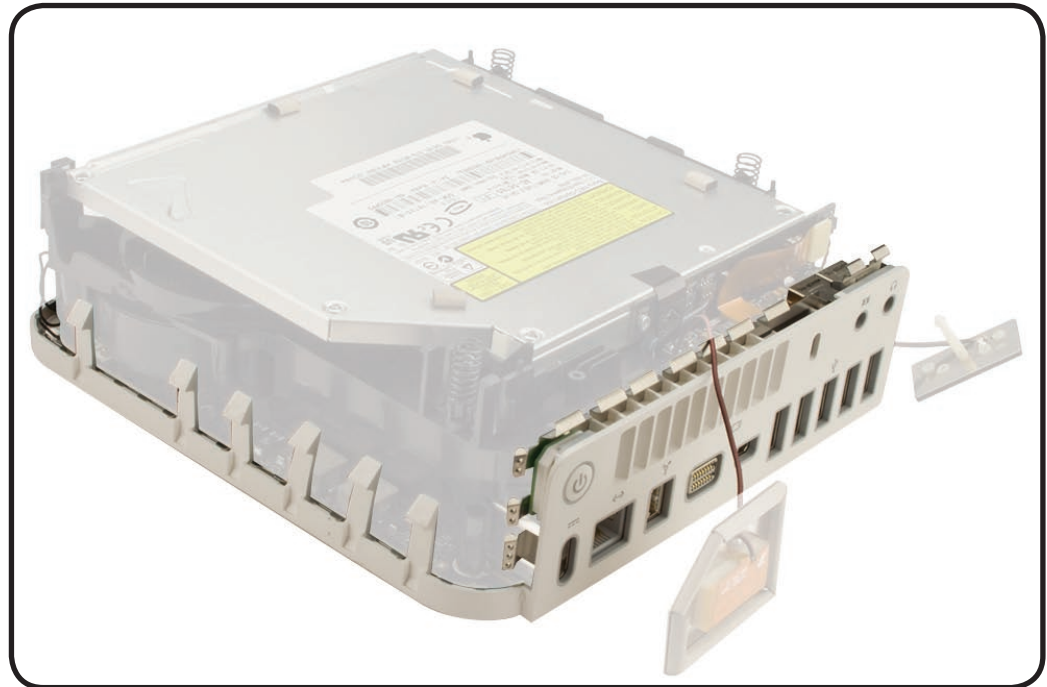

With all other modules removed or transferred, the bottom housing is the remaining assembly.

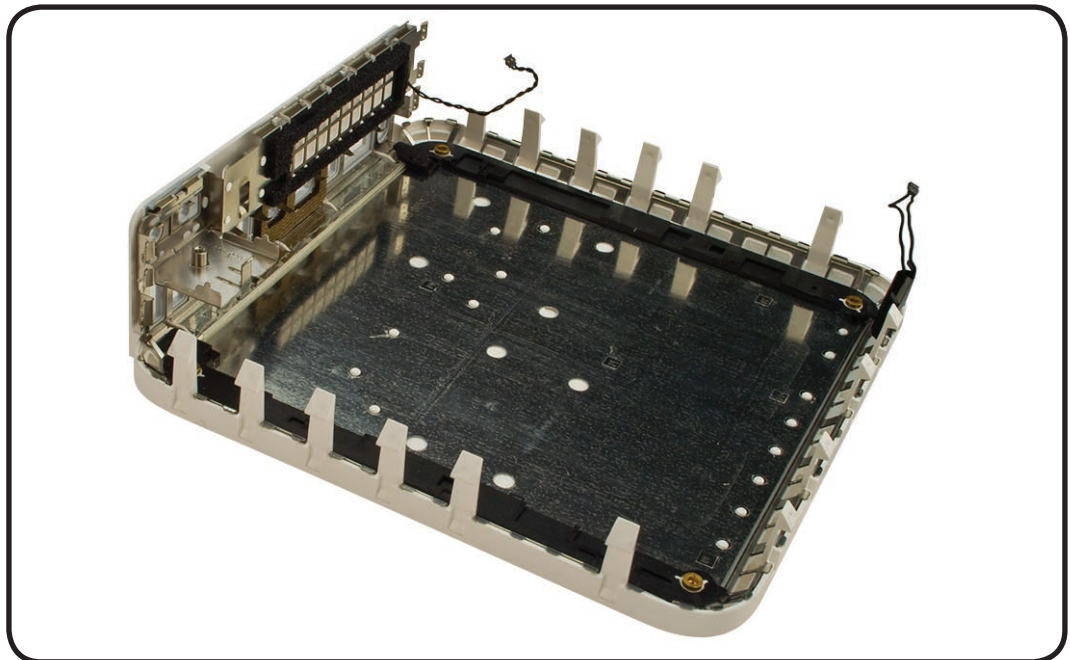

## **Views**

---

### **Mac mini (Late 2009)**

Mac mini (Late 2009) and Mac mini Server (Late 2009)



# Exploded View

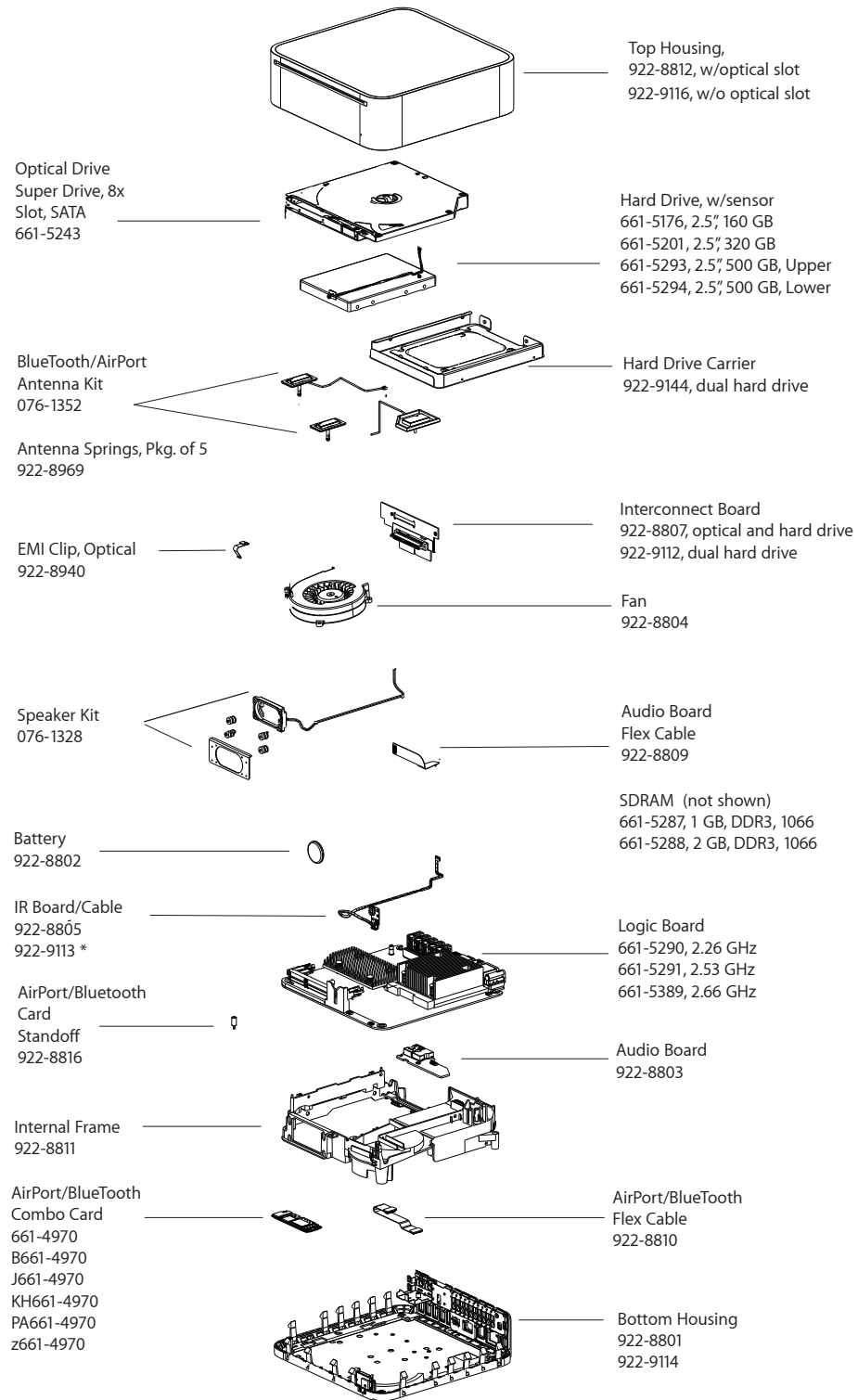



# Screw Chart

Note: Screws are not to scale.

<b>922-6680</b> <b>#0 Phillips</b>  - Optical drive (4) - Interconnect board (2) - AirPort/Bluetooth card (3)	<b>922-8822</b> <b>#1 Phillips</b>  - Hard drive (4)	<b>922-7325</b> <b>#0 Phillips</b>  - Logic board (3) - Audio board (1)
<b>922-7324, 8mm</b> <b>#1 Phillips</b>  - Logic board (1), near LED	<b>922-8816</b> <b>Torx T10</b>  - Logic board standoff	<b>922-8819</b> <b>#0 Phillips</b>  - Fan (2)
<b>922-8820</b> <b>#0 Phillips</b>  - IR board (1)	<b>922-6925</b> <b>#1 Phillips</b>  - Speaker (4)	<b>922-8969</b>  - Spring, antennas (1 each)





# Internal Views

## Front View

Speaker, optical drive, battery, IR board, power-on LED

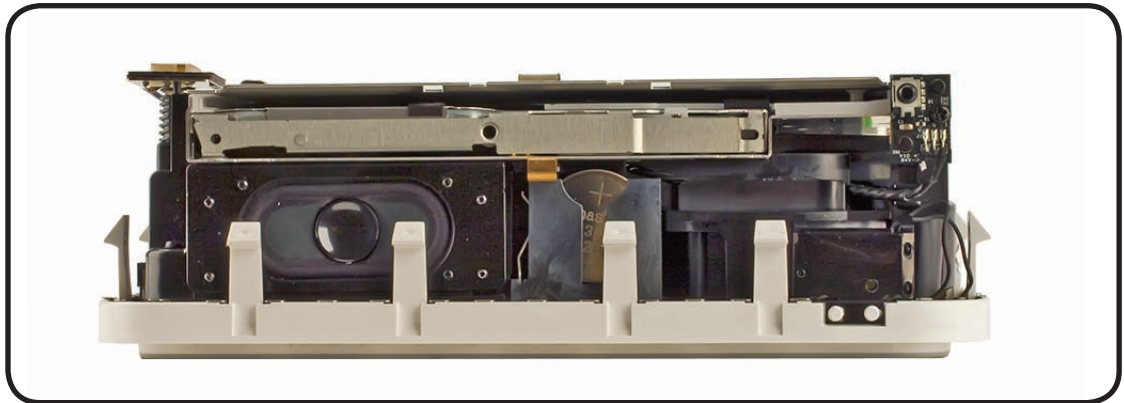

## Side View 1

AirPort antenna, optical drive, internal frame

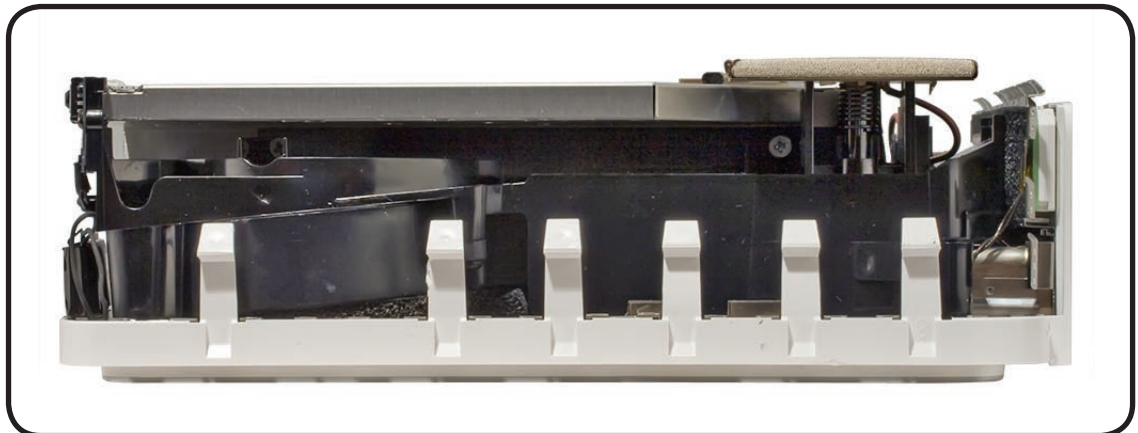



## Side View 2

AirPort antenna, Bluetooth antenna, audio board, internal frame

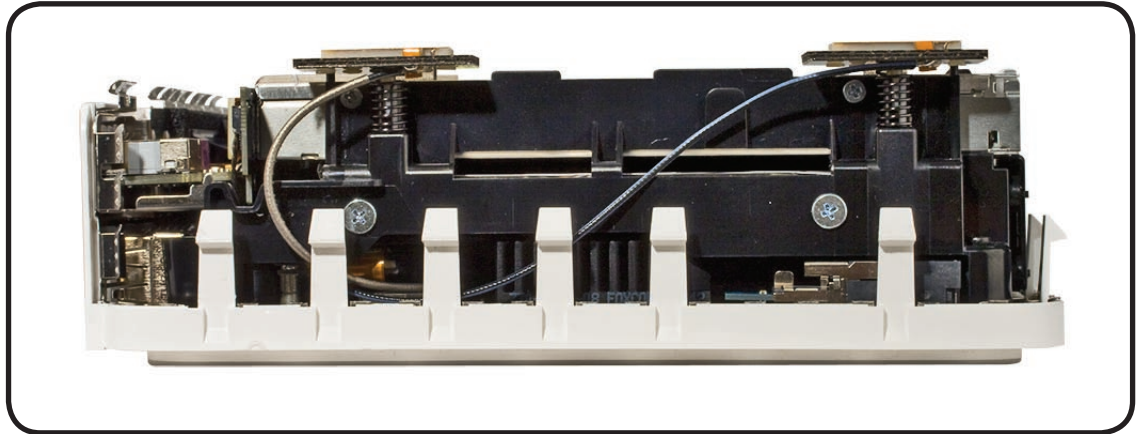

## Mac mini w/Optical





## Mac mini Server w/Dual Hard Drives

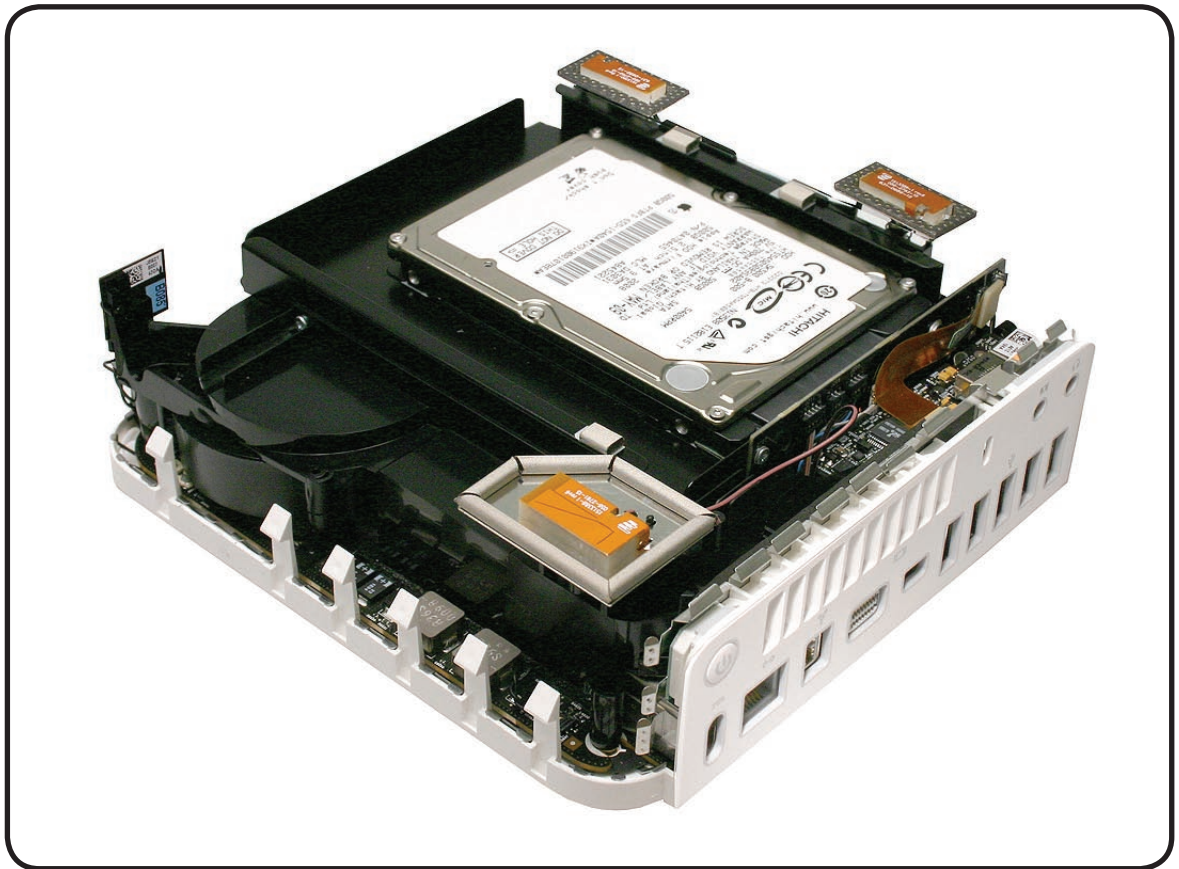



## Port View

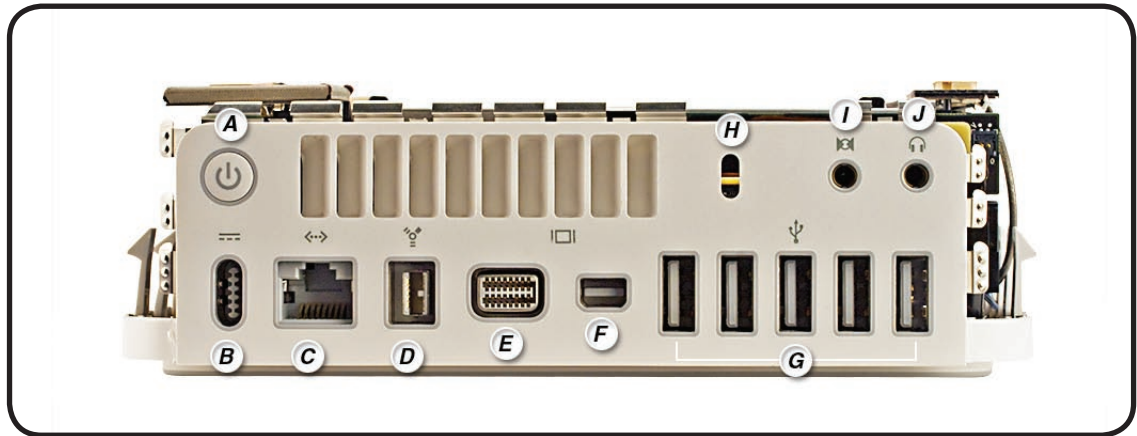

A = Power-on button

B = AC inlet

C = Gigabit Ethernet

D = FireWire 800

E = Mini-DVI port

F = Mini DisplayPort

G = USB 2.0 ports

H = Kensington Lock

I = Audio line out

J = Audio line in