

< GSM >

	MODE		
	ANT_SEL0	ANT_SEL1	ANT_SEL2
GGM00000 TX	H	H	L
GGM00100 TX	H	L	L
GGM0000 RX	L	L	L
GGM000 RX	L	L	H
GGM00 RX	L	H	L
GGM00 H	L	H	L
UMTS 2100 RX/TX	H	L	H

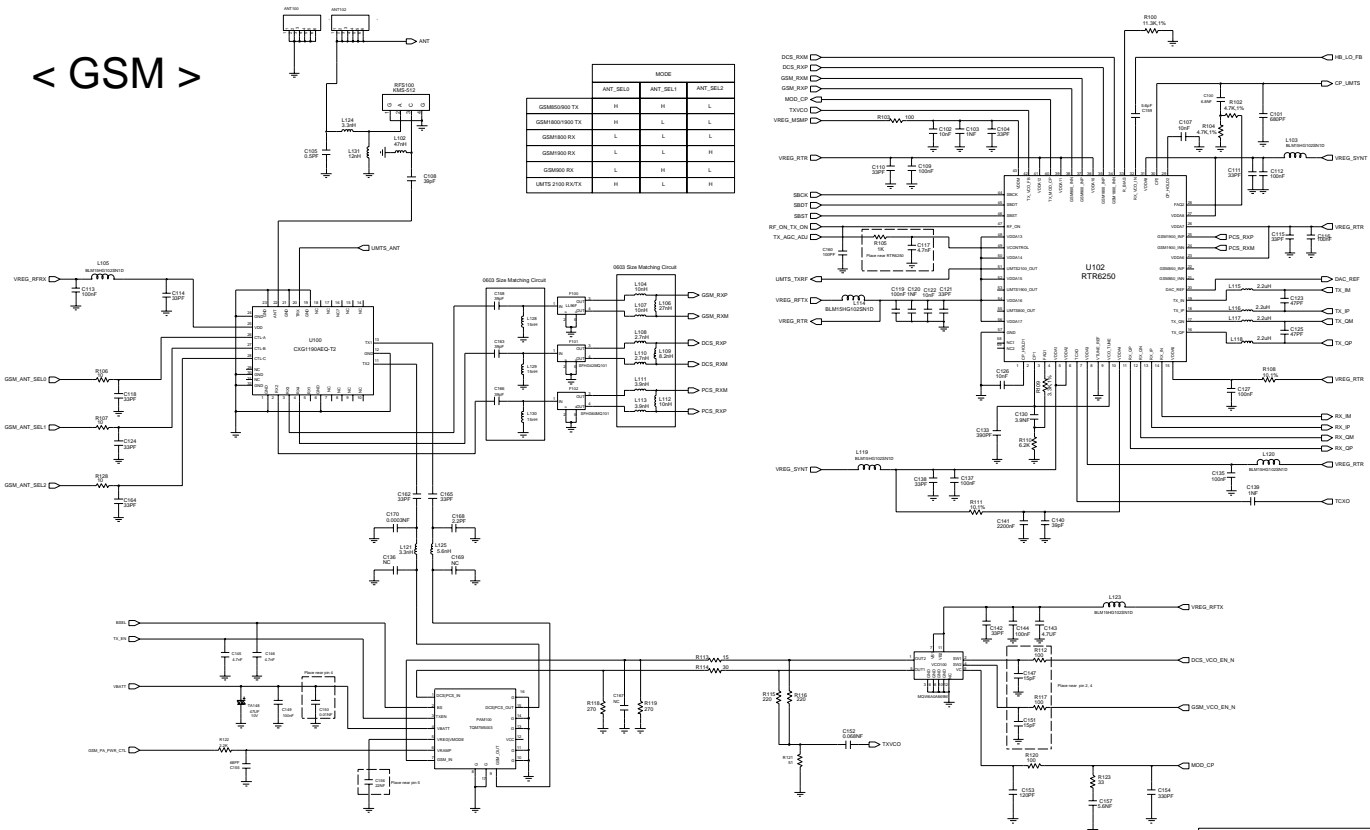

< WCDMA >

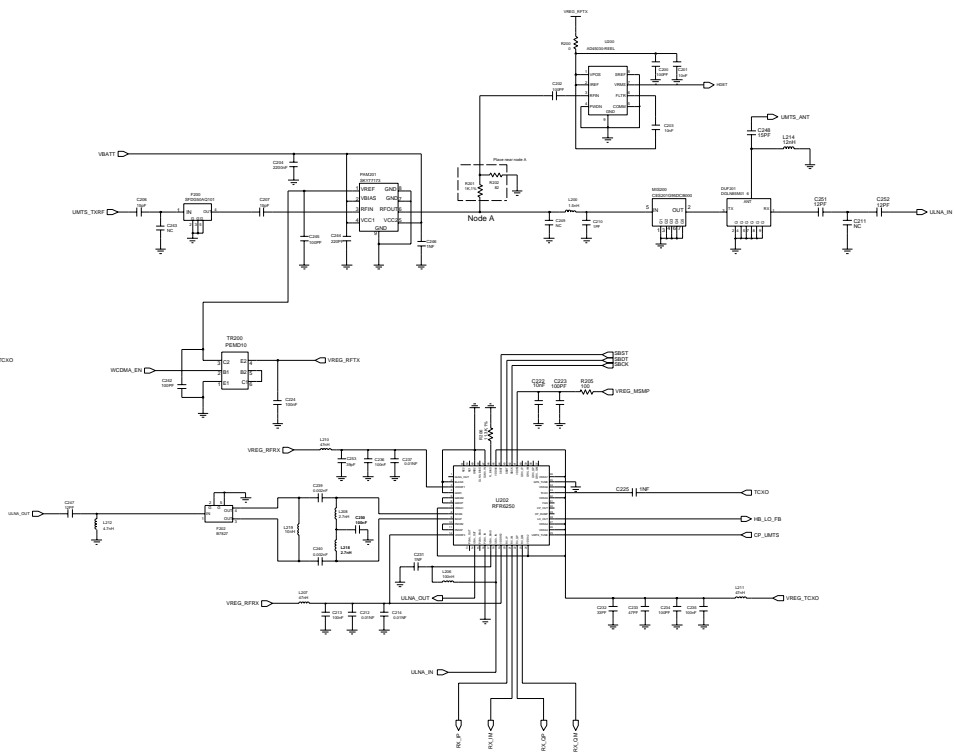
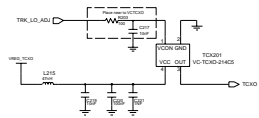

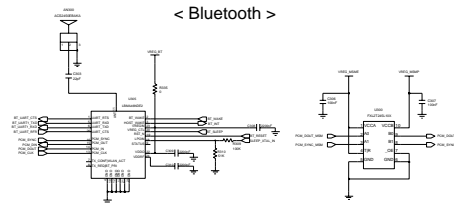
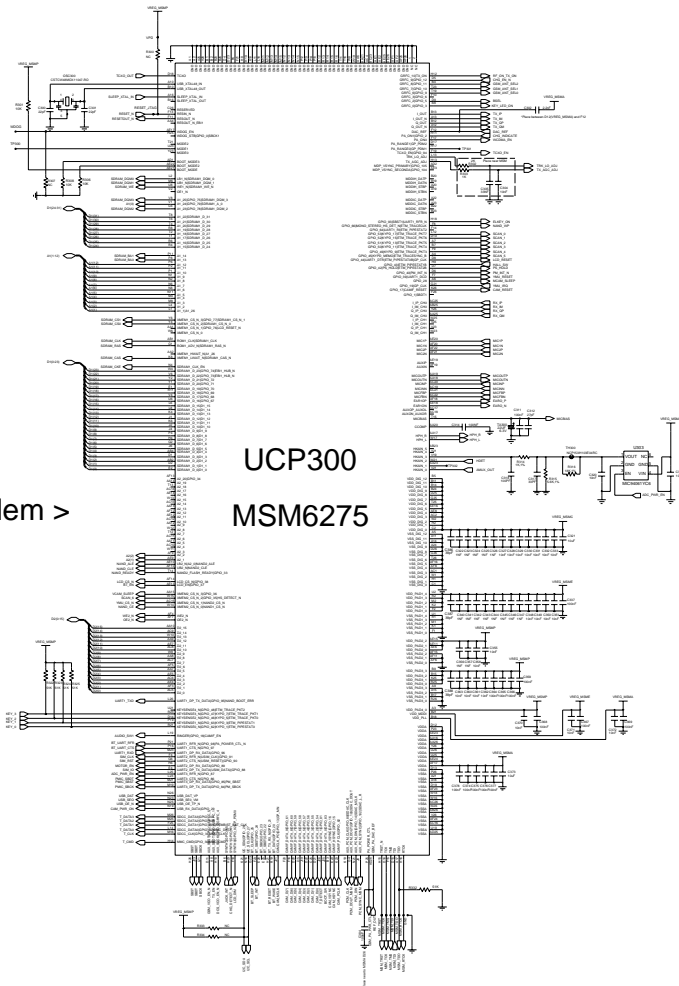

< Keypad LED Power >

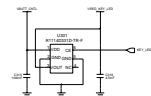

< USB Filter >

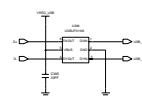

< MIC Feedback >

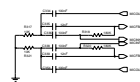

< VBATT Control >

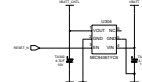

< USIM / T-Flash Connector >

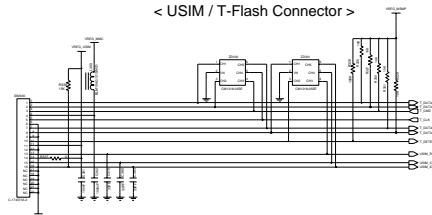



< Power Management IC >

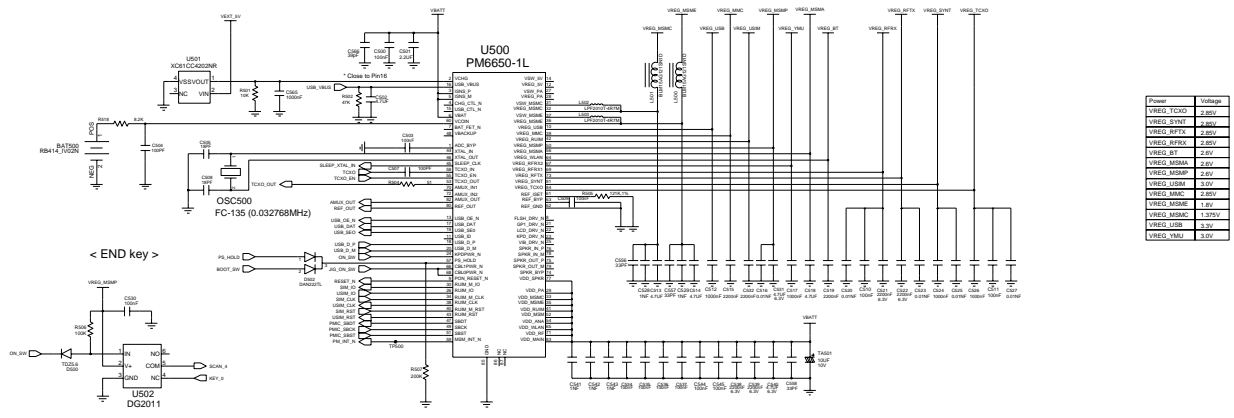

Power	Voltage
VREG_TCAD	2.80V
VREG_S1NF	2.80V
VREG_S1FX	2.80V
VREG_S1F	2.20V
VREG_S1M	2.20V
VREG_S1SP	2.20V
VREG_S1SM	2.20V
VREG_S1MC	2.20V
VREG_S1MS	1.80V
VREG_S1MC	1.30V
VREG_S1M	2.20V
VREG_S1AU	2.20V

< END key >

< Charging IC >

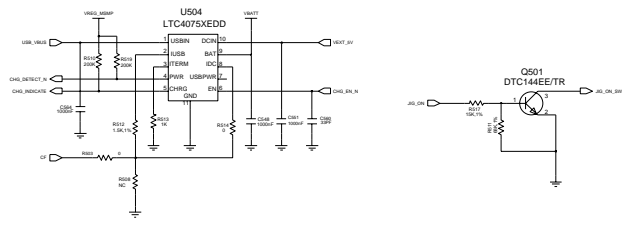

< Motor >

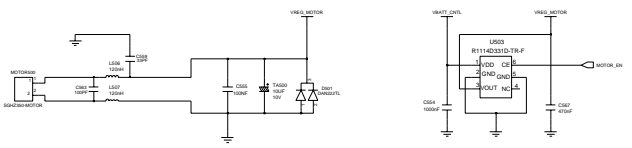

< Audio >

< Phone Mic Path >

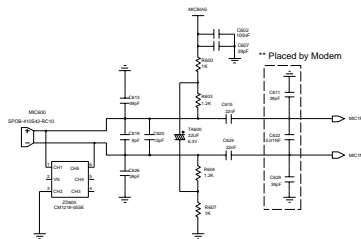

< Earphone Mic Path >

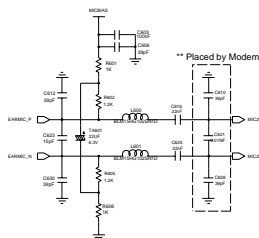

< Speaker Path >

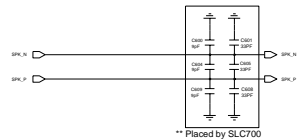

< Earphone Path >

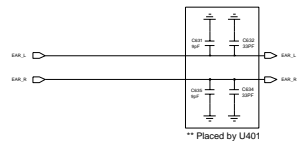

< Melody IC >

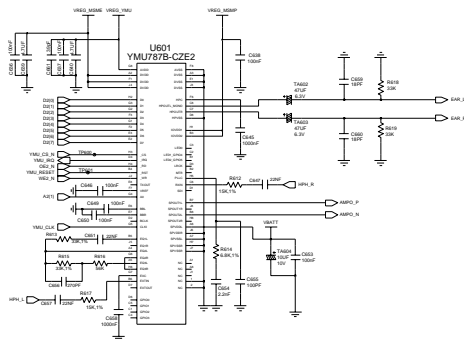
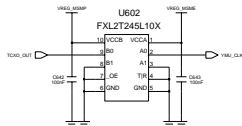

< Audio Switch 1 >

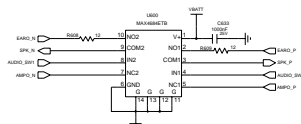

** Audio Switch Control

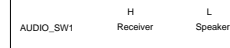

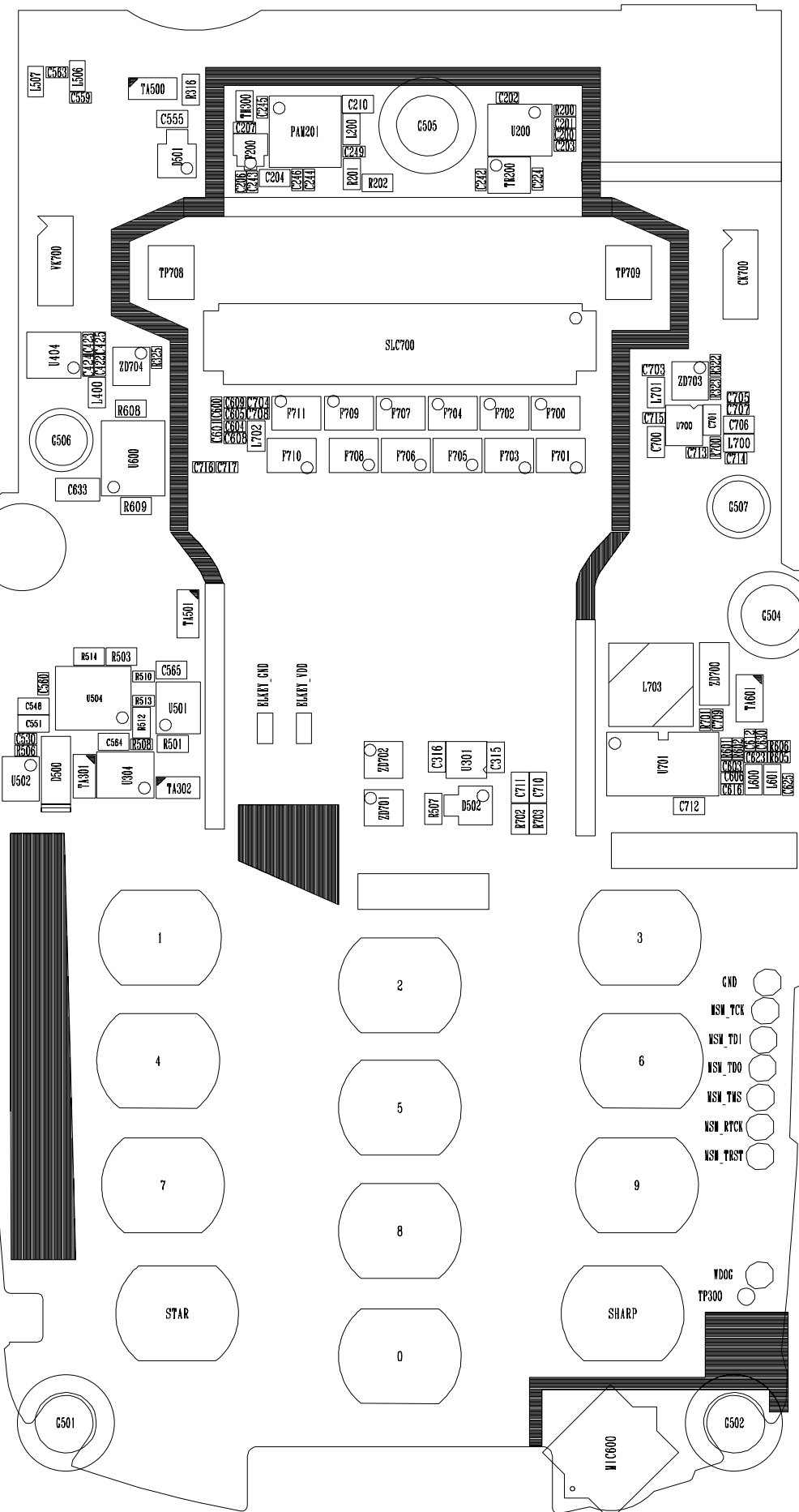

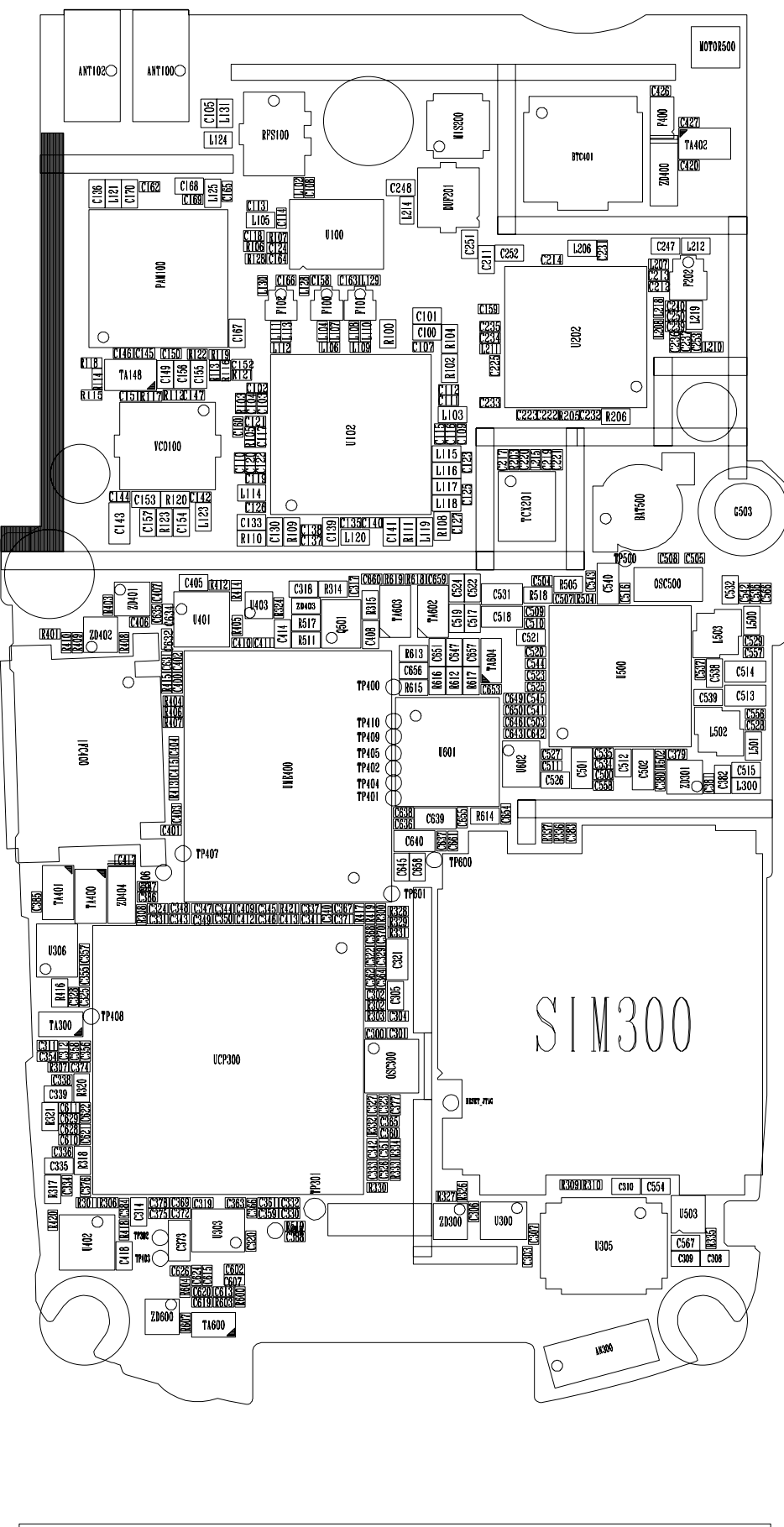

SIM300

