

	VC2 Control1	VC1 Control2
EGSM RADCS RX	0	0
DCS TX	0	1
EGSM TX	1	0

COMPANY NAME		Size
Engineer	Address	AS
Drawn by	City	
R&D CHK	TITLE:	
DOC CTRL CHK		
MFG ENDR CHK		
<b>SGH-P510</b>		

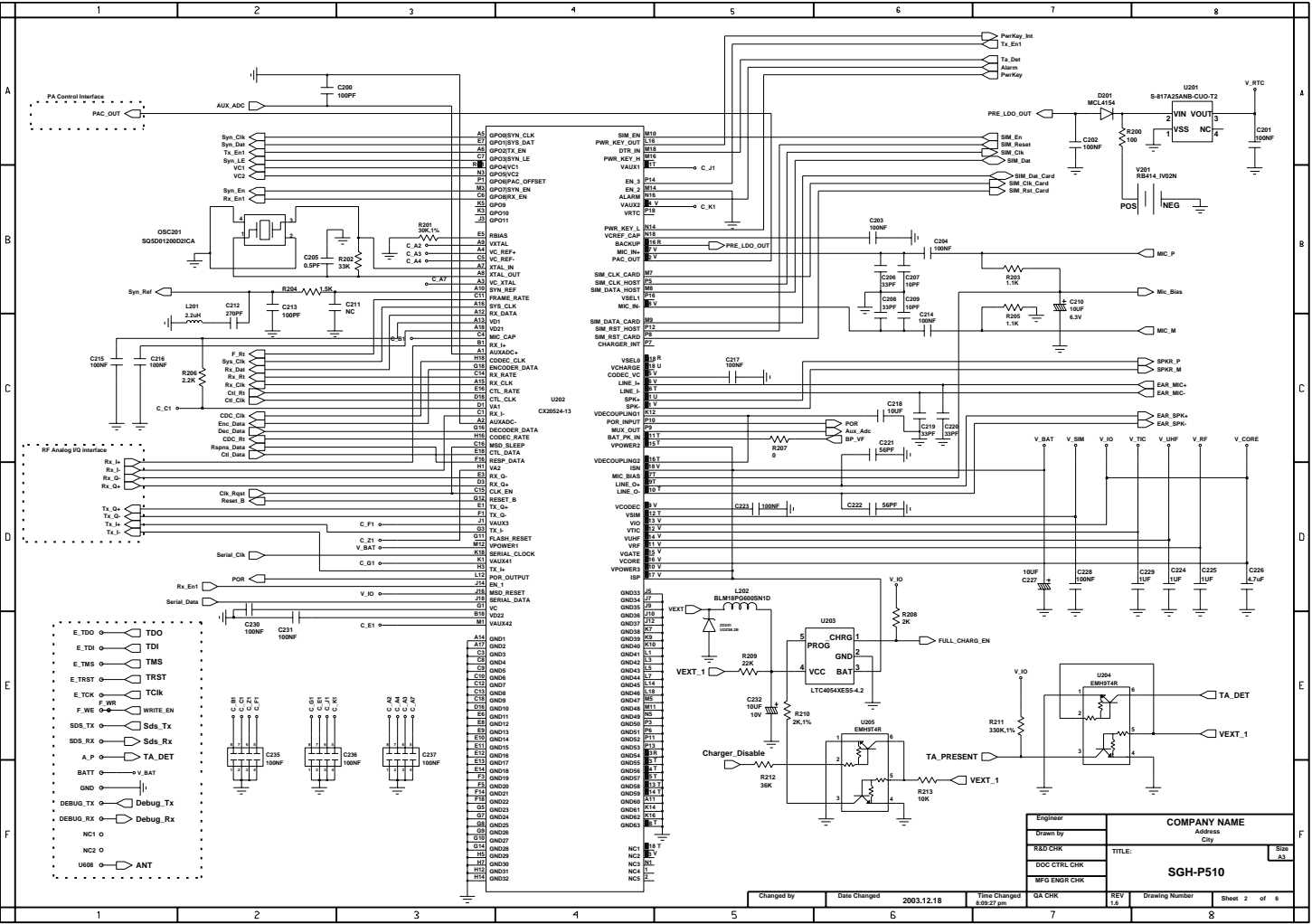

Engineer	COMPANY NAME
Drawn by	Address
READ CHK	City
DOC CTRL CHK	Site AS
MFG ENDR CHK	<b>SGH-P510</b>
Charged by	REV 1.6
Date Changed	2003.12.18
Time Changed	8:29:27 pm
CA/CHK	Drawing Number
Sheet 2 of 6	

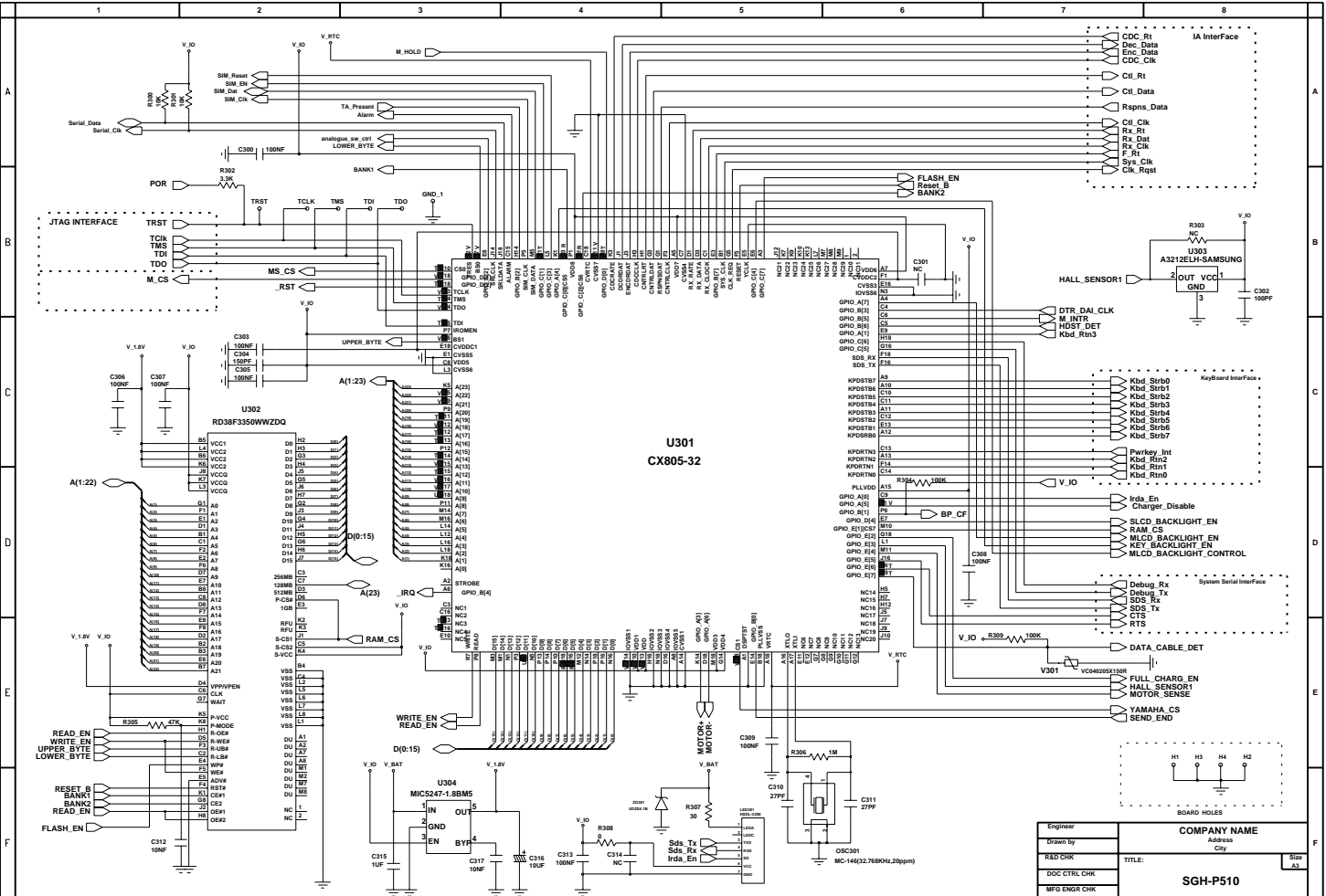

Company Name		Address		City	
Engineer	Drawn by	Rev	DATE	Time	Changed
READ CHK	DOC CTRL CHK	WFO ENDR CHK	SGH-P510		
TITLE:			REV 1.5		
DRAWING NUMBER			SHEET 3 OF 6		

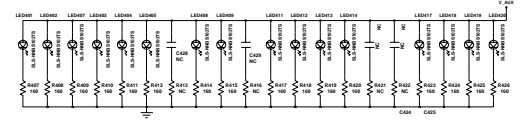
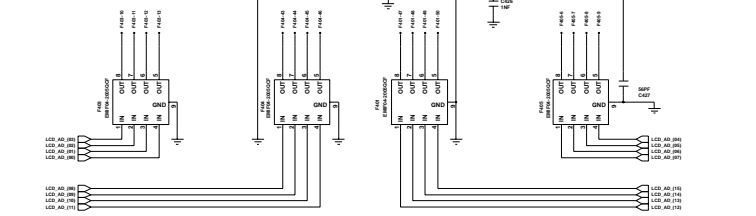
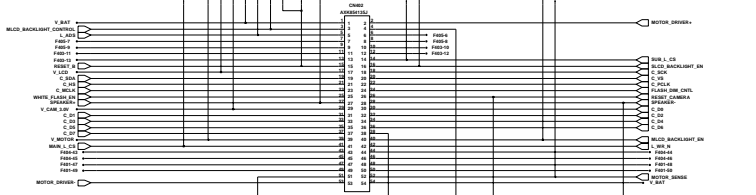
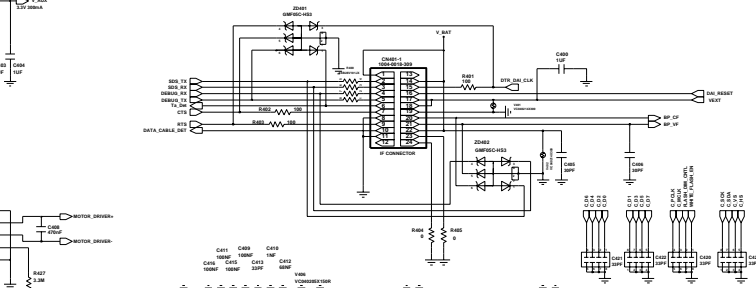
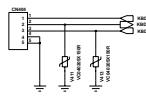
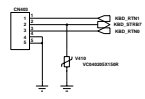
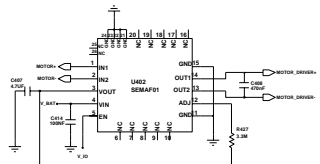
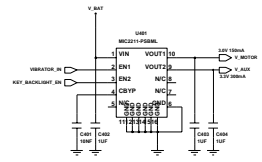
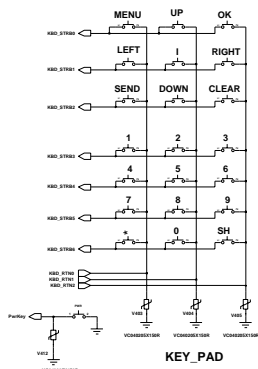

Engineer	COMPANY NAME	Size
Drawn by	Address	A5
Rev'd	City	
R&D CHK	TITLE:	
QC/Ctrl CHK		
MFG ENGR CHK		
	SGH-P510	

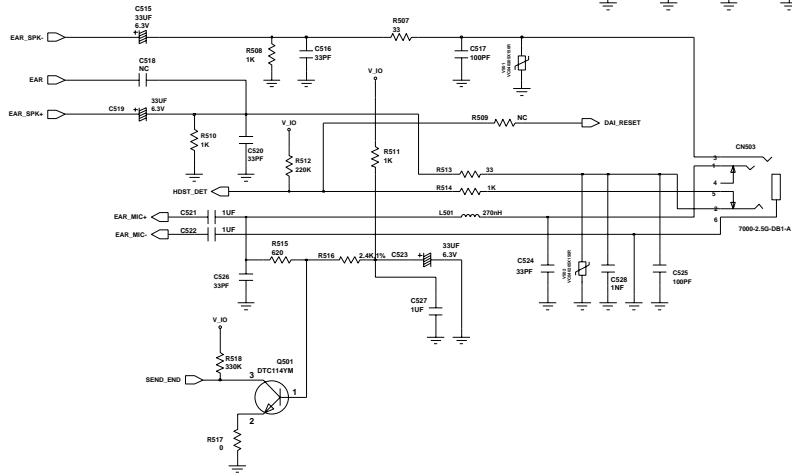
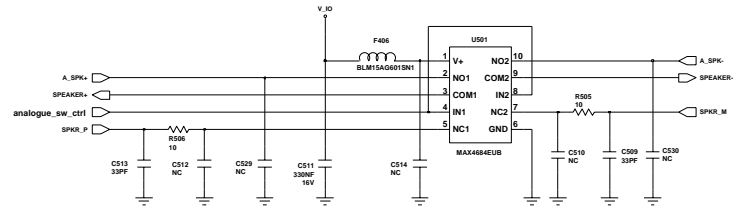
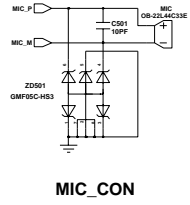
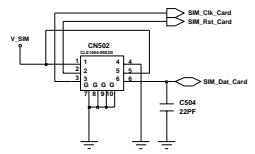
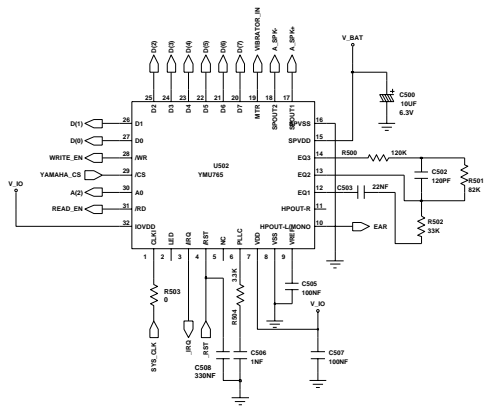

Engineer used	<b>COMPANY NAME</b> Address City State AS					
Drawn by						
DOC CTRL CHK						
MFG ENDR CHK						
<b>SGH-P510</b>						
Chang by user	Date Changed 2003.12.18	Time Changed 5:27:45 pm	GA CHK	REV 1.8	Drawing Number	Sheet 5 of 6

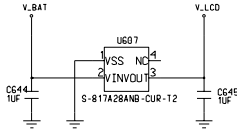
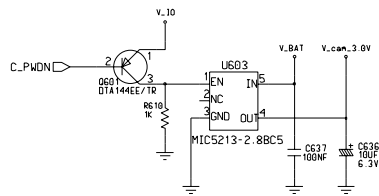
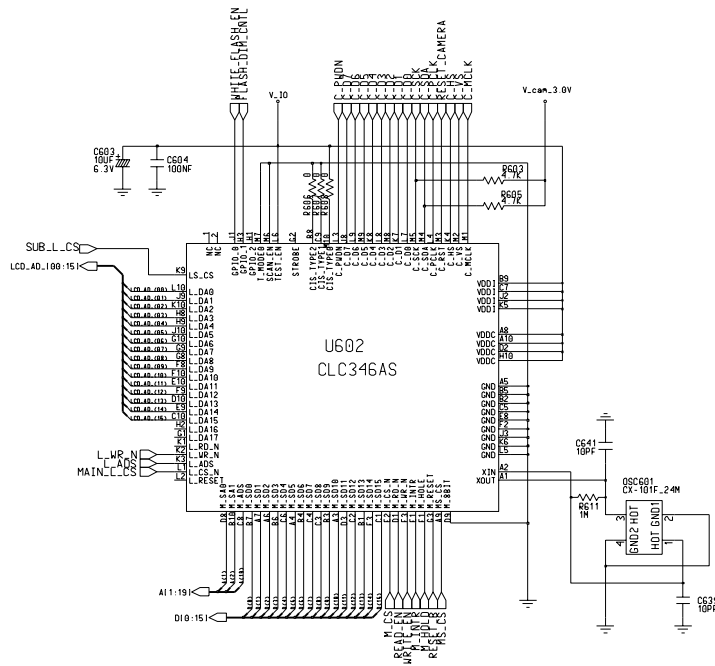

Engineer	COMPANY NAME	
Drawn by	Address	
Revu CHK	City	
Doc Ctrlr CHK	TITLE:	Size A3
Mfg ENDR CHK	SGH-P510	