

	VC2 Control1	VC1 Control2
EGSM RADCS RX	0	0
DCS TX	0	1
EGSM TX	1	0

Engineer		<b>COMPANY NAME</b> Address City	Size A3
Drawn by			
READ CHK	TITLE:		
DOC CTRL CHK			
WFO ENDR CHK		<b>SGH-P510</b>	

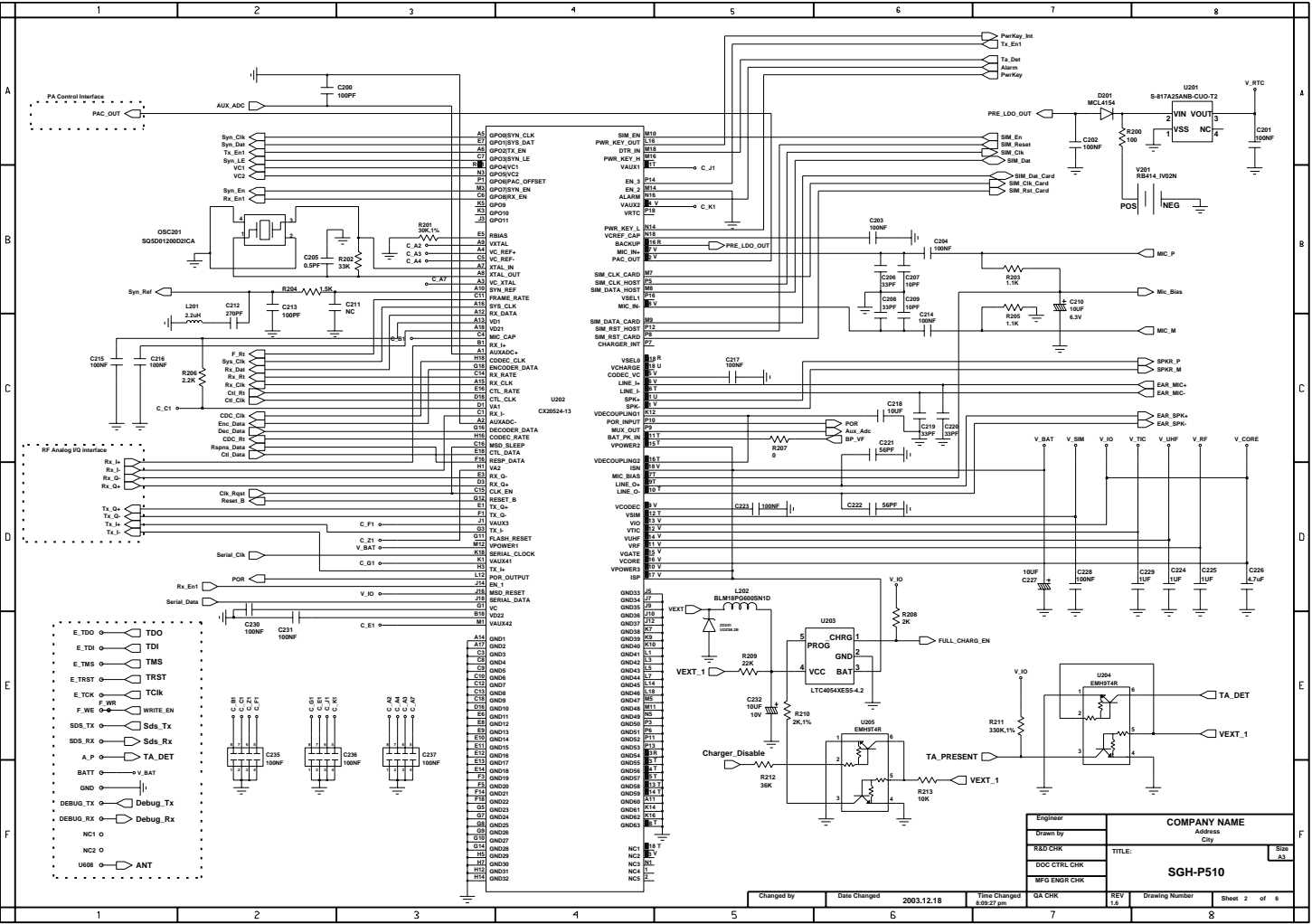

Engineer	COMPANY NAME		Size
Drawn by	Address		AS
Rev'd	City		
DOC CTRL CHK	TITLE:		
MFG ENDR CHK			
	<b>SGH-P510</b>		
Changed by	Date Changed	Time Changed	REV
	2003.12.18	8:29:27 pm	3.6
			Drawing Number
			Sheet 2 of 6

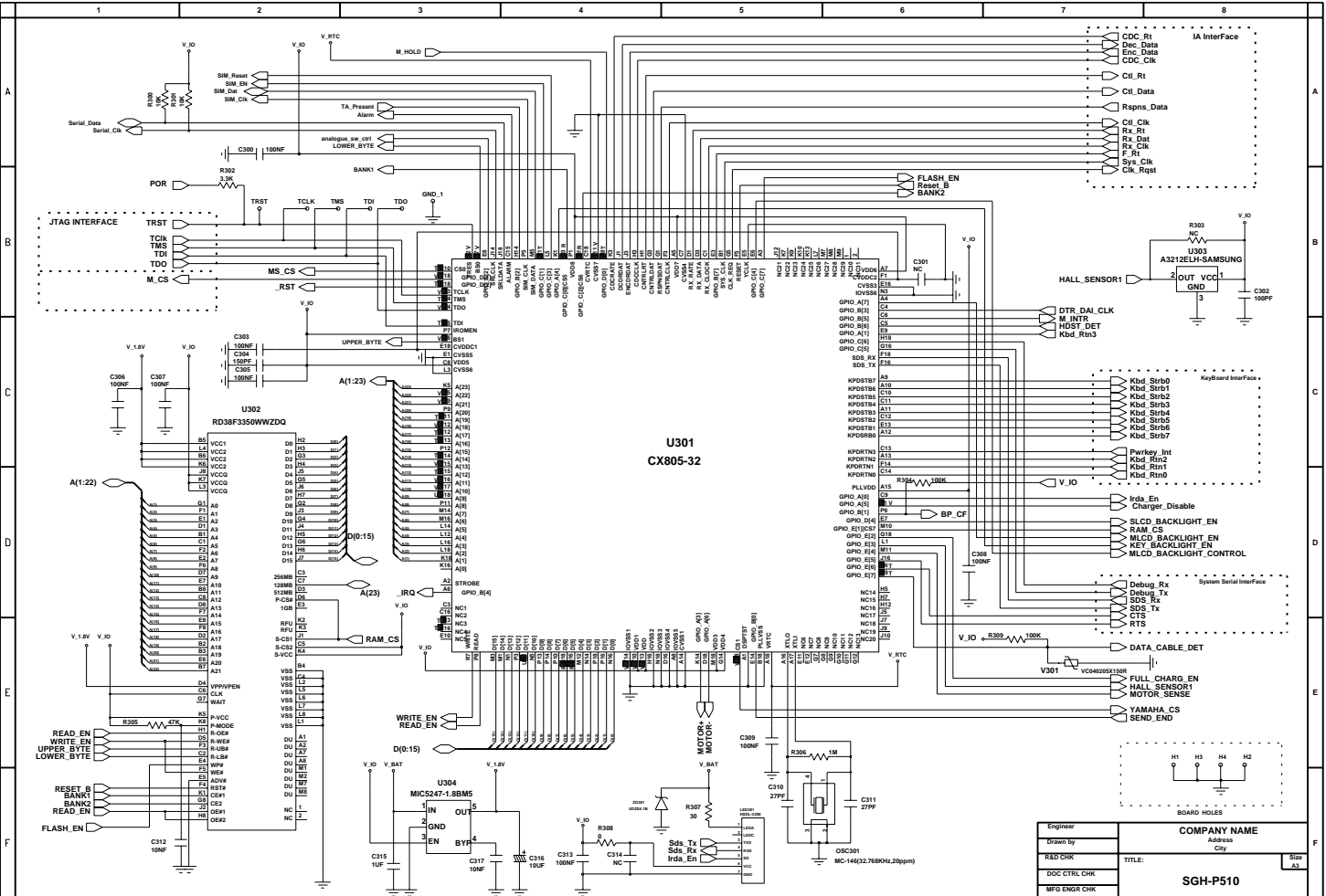

Engineer		COMPANY NAME	
Drawn by	Address		
READ CHK	City		
DOC CTRL CHK	TITLE:		
MFG ENDR CHK	SGH-P510		
Changed by	Date Changed	Time Changed	REV
	2003.12.18	8:29:49 pm	1.8
OC8301	MC-14932.7680Hz(20ppm)	CA CHK	Drawing Number
			Sheet 3 of 6

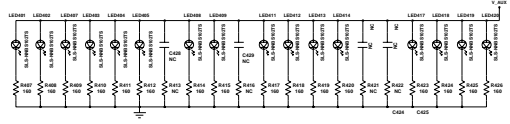
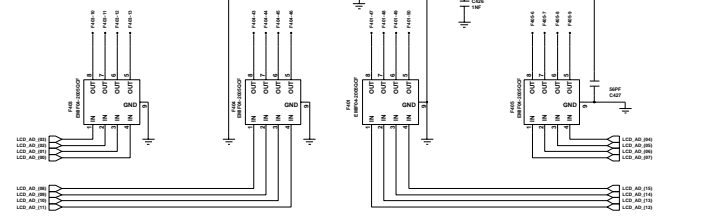
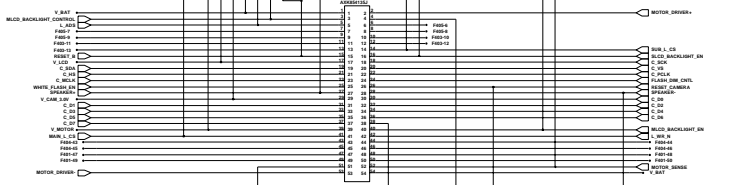
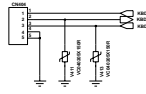
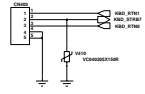
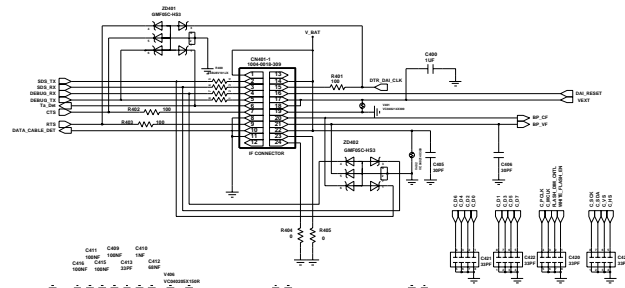
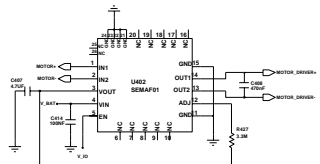
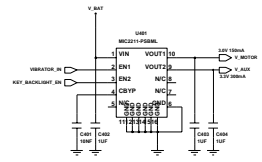
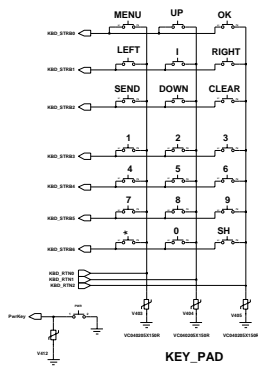

Engineer	COMPANY NAME	Size
Drawn by	Address	A5
Rev'd	City	
R&D CHK	TITLE:	
QC/Ctrl CHK		
MFG ENGR CHK		
	SGH-P510	

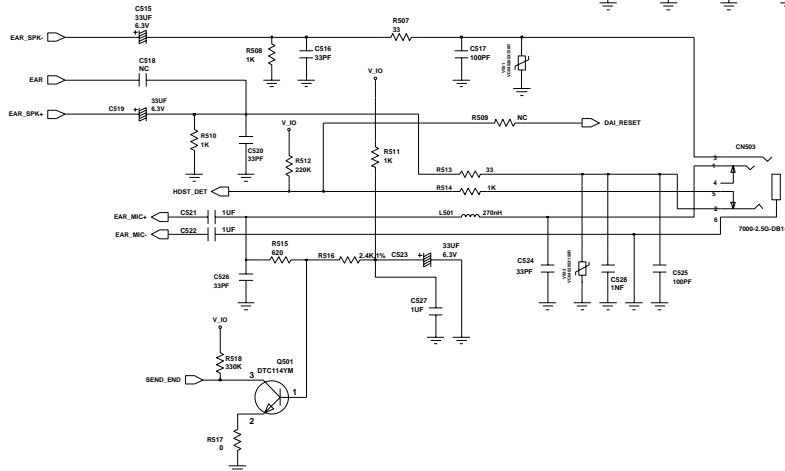
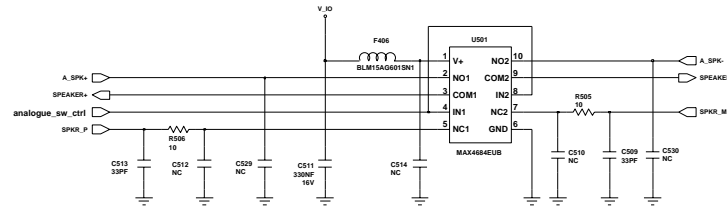
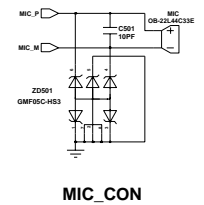
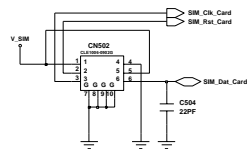
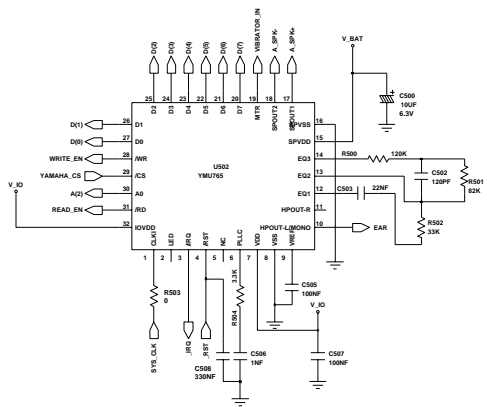

Engineer used	COMPANY NAME	Address	City
Drawn by			
REV CHK	TITLE:	Sheet 5 of 6	
DOC CTRL CHK		AS	
MFG ENDR CHK	<b>SGH-P510</b>		
CA CHK	REV	Drawing Number	Sheet 5 of 6
	1.8		

Changed by user Date Changed 2003.12.18 Time Changed 5:27:45 pm

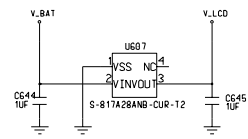
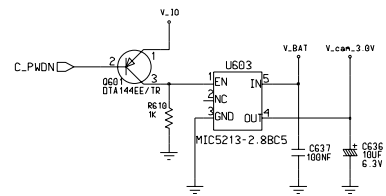
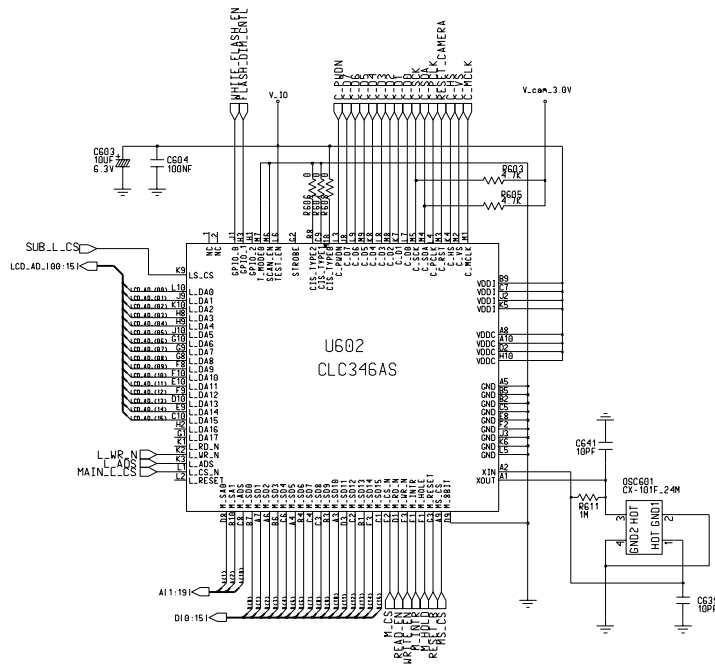

Engineer	COMPANY NAME		
Drawn by	Address		
Rev. CHK	City		
DOC. CTRL. CHK	TITLE:	Sheet	A3
PRO. ENDR. CHK	SGH-P510		