

**SAMSUNG**

# GSM TELEPHONE

## SGH-M300

# ***SERVICE*** *Manual*

### GSM TELEPHONE



### CONTENTS

1. Specification
2. Exploded View and Parts list
3. Chart of Troubleshooting
4. Array course control
5. Block Diagrams
6. PCB Diagrams
7. MAIN Electrical Parts List
8. Reference data
9. Safety Precautions
10. Product Function

# Contents

## 1. Specification

1-1. GSM/CDMA General Specification .....	1-1
1-2. GSM TX power class .....	1-2

## 2. Exploded View and Parts list

2-1. Cellular phone Exploded View .....	2-1
2-2. Cellular phone Parts list .....	2-2
2-3. Disassembly .....	2-4
2-4. Assembly .....	2-8
2-5. LCD KIT Assembly .....	2-10

## 3. Chart of Troubleshooting

3-1. Baseband .....	3-1
3-1-1. Power ON .....	3-1
3-1-2. System Initial .....	3-6
3-1-3. SIM Part .....	3-8
3-1-4. Charging Part .....	3-10
3-1-5. Microphone Part .....	3-13
3-1-6. Speaker Part .....	3-16
3-1-7. Receiver Part .....	3-20
3-1-8. Camera Part .....	3-22
1) 2Mega Camera .....	3-22
2) VGA Camera .....	3-23
3-1-9. LCD .....	3-26
3-2. RF .....	3-13
3-2-1. EGSM Receiver .....	3-30
3-2-2. EGSM Transmitter .....	3-31
3-2-3. DCS Receiver .....	3-32
3-2-4. DCS Transmitter .....	3-33
3-2-5. PCS Receiver .....	3-34
3-2-6. PCS Transmitter .....	3-35
3-2-7. UMTS Receiver .....	3-40
3-2-8. UMTS Transmitter .....	3-41
3-2-9. BLUETOOTH .....	3-45

---

# Contents

## 4. Array course control

4-1. Downloading Binary Files .....	4-2
4-2. Pre-requisite for Downloading .....	4-2
4-3. S/W Downloader Program .....	4-3

## 5. Block Diagrams

## 6. PCB Diagrams

## 7. MAIN Electrical Parts List

## 8. Reference data

8-1. Reference Abbreviate .....	8-1
---------------------------------	-----

## 9. Safety Precautions

9-1. Repair Precaution .....	9-1
9-2. ESD(Electrostatically Sensitive Devices) Precaution .....	9-2

## 10. Product Function

---

---

# 1. Specification

---

## 1-1. GSM General Specification

	<b>GSM 900 Phase 1</b>	<b>EGSM 900 Phase 2</b>	<b>DCS1800 Phase 1</b>
Freq. Band[MHz] Uplink/Downlink	890~915 935~960	880~915 925~960	1710~1785 1805~1880
ARFCN range	1~124	0~124 & 975~1023	512~885
Tx/Rx spacing	45 MHz	45 MHz	95 MHz
Mod. Bit rate/ Bit Period	270.833 Kbps 3.692 us	270.833 Kbps 3.692 us	270.833 Kbps 3.692 us
Time Slot Period/Frame Period	576.9 us 4.615 ms	576.9 us 4.615 ms	576.9 us 4.615 ms
Modulation	0.3 GMSK	0.3 GMSK	0.3 GMSK
MS Power	33 dBm~13 dBm	33 dBm~5 dBm	30 dBm~0 dBm
Power Class	5 pcl ~ 15 pcl	5 pcl ~ 19 pcl	0 pcl ~ 15 pcl
Sensitivity	-102 dBm	-102 dBm	-100 dBm
TDMA Mux	8	8	8
Cell Radius	35 Km	35 Km	2 Km

**1-2. GSM TX power class**

<b>TX Power control level</b>	<b>GSM900</b>	<b>TX Power control level</b>	<b>DCS1800</b>
5	33±2 dBm	0	30±3 dBm
6	31±2 dBm	1	28±3 dBm
7	29±2 dBm	2	26±3 dBm
8	27±2 dBm	3	24±3 dBm
9	25±2 dBm	4	22±3 dBm
10	23±2 dBm	5	20±3 dBm
11	21±2 dBm	6	18±3 dBm
12	19±2 dBm	7	16±3 dBm
13	17±2 dBm	8	14±3 dBm
14	15±2 dBm	9	12±4 dBm
15	13±2 dBm	10	10±4 dBm
16	11±3 dBm	11	8±4 dBm
17	9±3 dBm	12	6±4 dBm
18	7±3 dBm	13	4±4 dBm
19	5±3 dBm	14	2±5 dBm
		15	0±5 dBm

## 2. Exploded View and Parts List

### 2-1. Cellular phone Exploded View

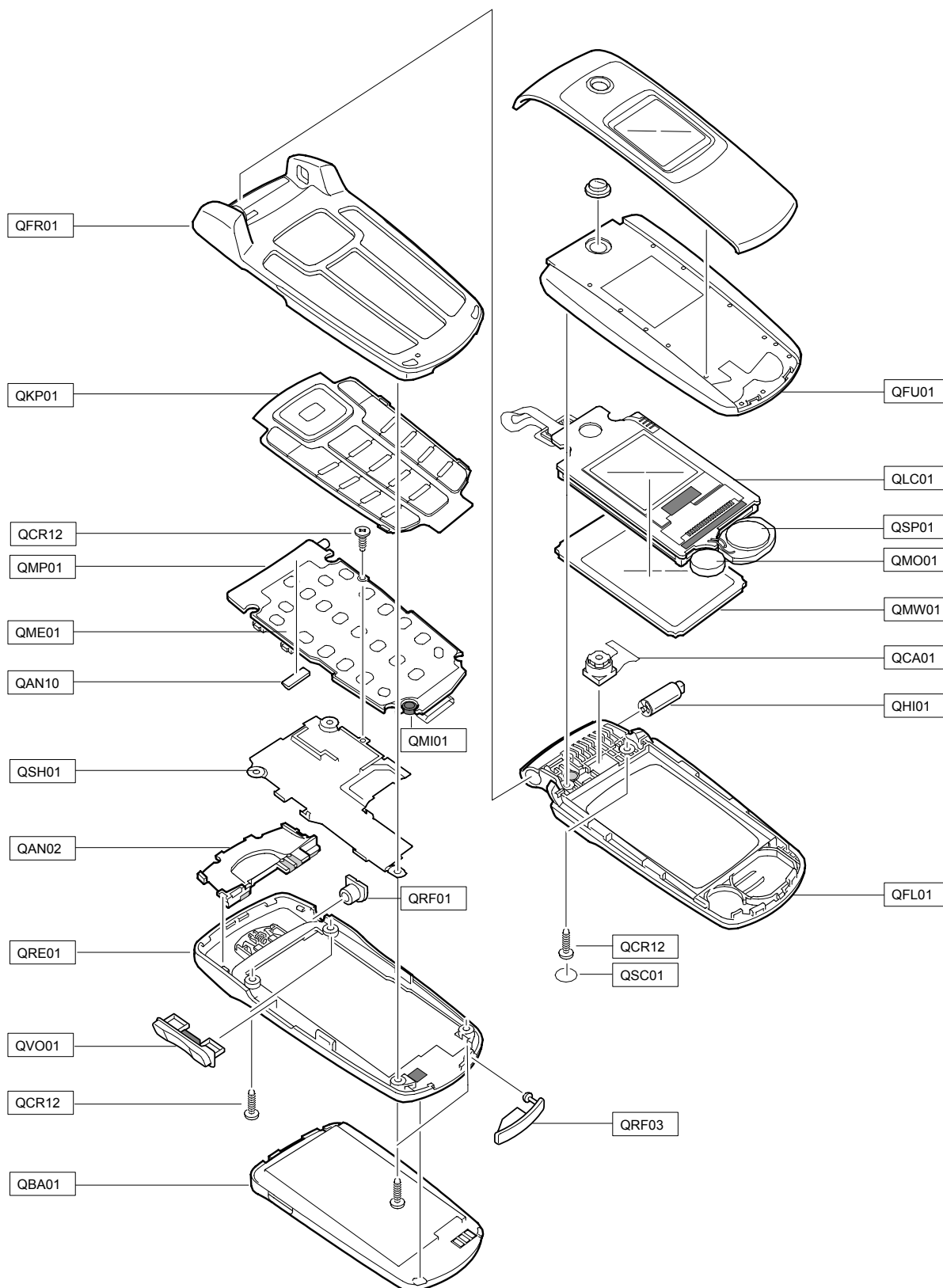



**2-2. Cellular phone Parts list**

Design LOC		Discription	SEC CODE
QAN02		INTENNA-SGH-M300	GH42-01219A
QAN10		ASSY-CUSHION-ANT CONTACT RUBBE	GH98-01218A
QBA01		BATTERY-700MAH.MAIN,ENG,OCEAN	GH43-02873A
QCA01		UNIT-CAMERA MODULE	GH59-04349A
QCR12		SCREW-MACHINE	6001-001530
QCR12		SCREW-MACHINE	6001-001530
QCR12		SCREW-MACHINE	6001-001530
QFR01		ASSY CASE-FRONT	GH98-04187B
QFU01		ASSY CASE-FOLDER UPPER	GH98-04189B
QKP01		ASSY KEYPAD-(XET/EB)	GH98-04194B
QME01		UNIT-DOME SHEET 22 KEY	GH59-04499A
QMI01		MICROPHONE-ASSY-SGH_B600	GH30-00369A
QMO01		MOTOR DC-SGHS342I	GH31-00119A
QMP01		PBA MAIN-SGH_M300	GH92-03849A
QRF01		PMO-COVER RF	GH72-38610A
QSC01		MPR-SHEET SCREW CAP	GH74-30953A
QSH01		ASSY CASE-SHIELD CAN	GH98-04632A
QSP01		SPEAKER	3001-002153
QVO01		ASSY KEY-VOLUME	GH98-05305A
QLC01		ELA UNIT-SGH-M300 LCD MODULE	GH96-02546A
	QMW01	ASSY COVER-MAIN WINDOW	GH98-04255A
QRE01		ASSY CASE-REAR	GH98-04191A
	QRF03	PMO-COVER EAR IF	GH72-38609A
QFL01		ASSY CASE-FOLDER LOWER	GH98-04190A
	QHI01	ASSY HINGE	GH98-03590A

Discription	SEC CODE
BAG PE	6902-000297
ADAPTOR-SGHE690,SIL,EU,A_TYPE	GH44-01361B
UNIT-20P,EARPHONE,SIL,B-TYPE	GH59-04029B
LABEL(R)-WATER SOAK	GH68-09361A
MANUAL USERS-EU GERMAN	GH68-14617A
LABEL(R)-MAIN EU	GH68-14836A
BOX(P)-UNIT MAIN EU	GH69-05422A
MPR-SUB LCD CONN GAS	GH74-10794A
MPR-REMOVE TAPE LCD	GH74-13804A
MPR-LCD PCB MASK TAPE B	GH74-15067A
MPR-TAPE LED	GH74-17926A
MPR-INSU TAPE	GH74-19264A
MPR-GASKET TAPE	GH74-27014A
MPR-INSU TAPE SUB LCD	GH74-27510A
MPR-INSU TAPE	GH74-27512A
MPR-INSU TAPE	GH74-29298A
MPR-TAPE MAIN FPCB	GH74-30585A
MPR-INSU TAPE	GH74-30759A
MPR-TAPE MAIN FPCB	GH74-30860A
MPR-VINYL BOHO MAIN WINDOW	GH74-31871A
MPR-VINYL BOHO MAIN WINDOW	GH74-31987A
VINYL-BOHO MAIN	GH74-32579A
TAPE GASK-LCD SIDE A	GH74-32812A
TAPE-BACKLIGHT	GH74-32834A
TAPE-MAIN WINDOW	GH74-32837A
TAPE	GH74-33042A
TAPE-PCB GASKET	GH74-33071A
SPONGE	GH74-33094A
TAPE INSU	GH74-33095A

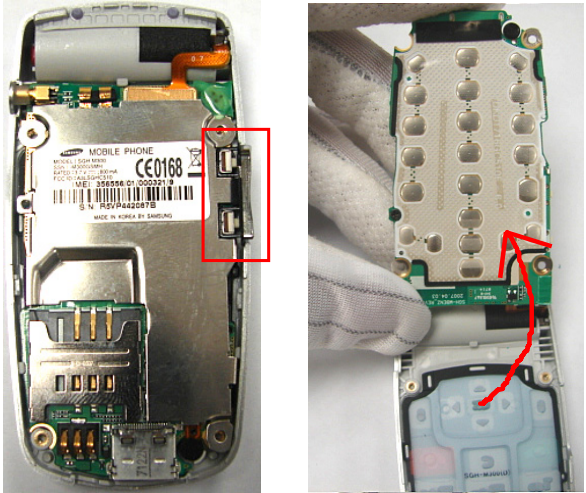
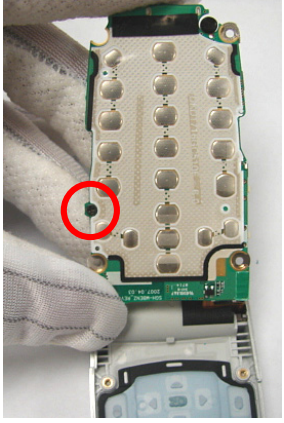

### 2-3. Disassembly

<p><b>1</b></p> 	<p><b>2</b></p>  <p>(1) (2) (3)</p>
<p>1) Unscrew 4points from the rear case 2) Open the IF COVER</p> <p><b>* caution</b></p> <p>1) Be care of Shooting out damage and scratch not to occur.</p>	<p>1) Disjoint from left low side to up side of rear case as below picture.</p> <p><b>* caution</b></p> <p>1) When you disjoint a rear case, be care of Shooting out damage and scratch not to occur.</p>
<p><b>3</b></p> 	<p><b>4</b></p> 
<p>1) Remove the Volume key. 2) Disjoint B'd from front case.</p> <p><b>* caution</b></p> <p>1) During disconnecting the B'd from FRONT, pay attention not to tear the LCD FPCB.</p>	<p>1) Remove the shield can screw 2) Disjoint shield can from B'd</p> <p><b>* caution</b></p> <p>1) Pay attention not to damage for LCD FPCB during disconnecting the Shield can screw.</p>

5

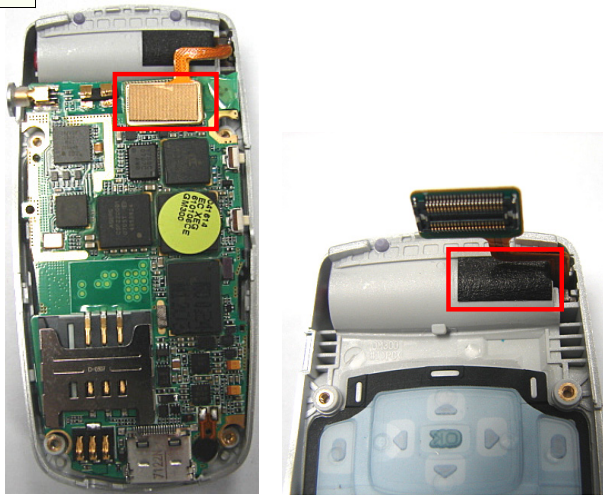

- 1) Disconnect the LCD connector and Disjoint the B'd
  - 2) Remove the dust protection tape
- \* caution**
- 1) Be care of Shooting out damage and scratch not to occur.
  - 2) Pay attention not to damage for LCD FPCB.

6

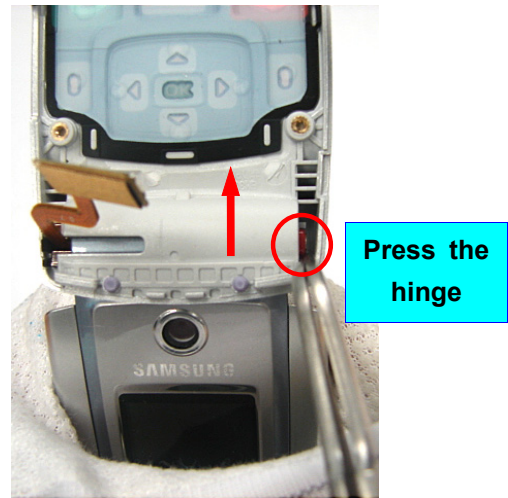

- 1) Pressing the hinge using the rounded tweezers or sort of thing, disjoint FRONT.
- \* caution**
- 1) Be care of Shooting out damage and scratch not to occur.

7



- 1) Remove screw cover using tweezers.
  - 2) Unscrew at the folder upper using a screwdriver
- \* caution**
- 1) Be care of Shooting out damage and scratch not to occur.

8

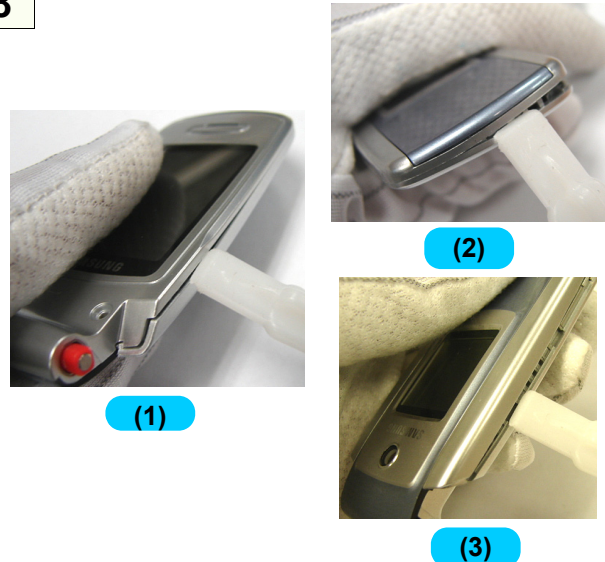

- 1) After disjoint the hooker of the lower side, disassemble the LOWER case as below the picture.
- \* caution**
- 1) Be care of Shooting out damage and scratch not to occur.

9

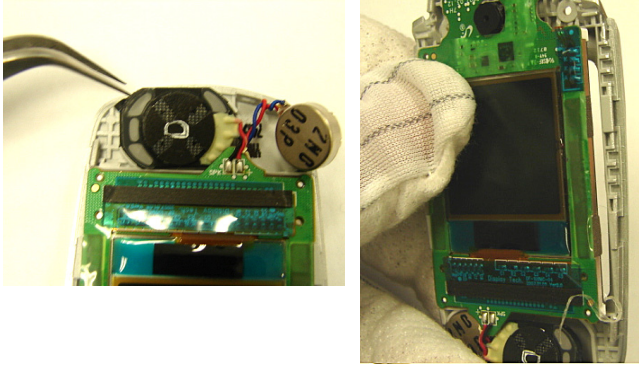

- 1) Remove the Speaker/Motor in the LOWER.
- 2) Remove the LCD in the LOWER.

※ **caution**

- 1) Be care of Speaker/Motor wire cracking or damage.

10

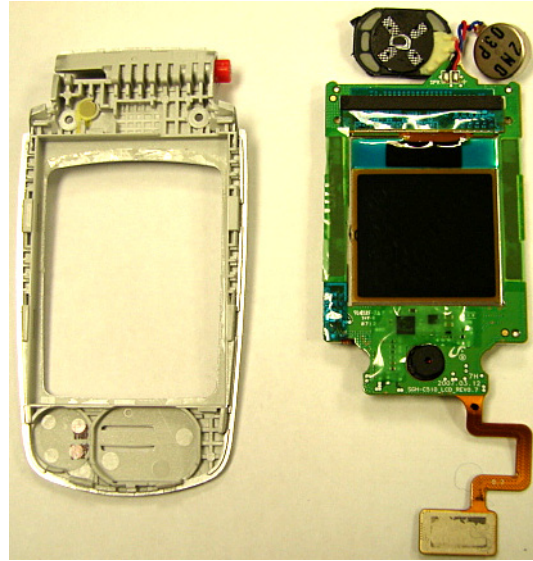





- 1) Check the separated plastics.

※ **caution**

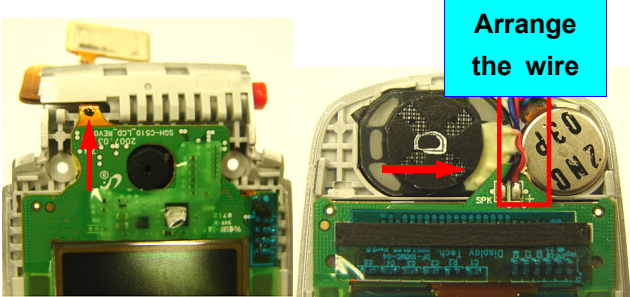
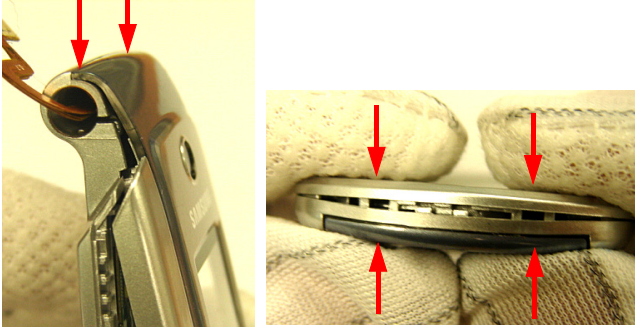
- 1) Check all of the material is taped.

## 2-4. Assembly

<p><b>1</b></p> 	<p><b>2</b></p> 
<p>1) Put the LOWER hinge hall to the LCD FPCB, and then put the camera to the PCB.                  2) Put the Speaker to the LOWER case, and then arrange the Wire. Put the speaker to the LOWER case, right side slightly.  <b>* caution</b>                  1) Be care of SPEAKER/MOTOR wire cracking or damage.</p>	<p>1) Joint folder hinge side of UPPER case.                  2) Joint folder UPPER case side and edge.  <b>* caution</b>                  1) Be care of Shooting out damage and scratch not to occur.</p>
<p><b>3</b></p> 	<p><b>4</b></p> 
<p>1) Screw two point of FOLDER Ass'y.                  2) Assemble the SCREW COVER  <b>* caution</b>                  1) Be care of Shooting out damage and scratch not to occur.</p>	<p>1) Put the FPCB to the FRONT hole.                  2) Pressing the red colored hinge, assembly the folder and FRONT case  <b>* caution</b>                  1) Pay attention not to damage for LCD FPCB.</p>

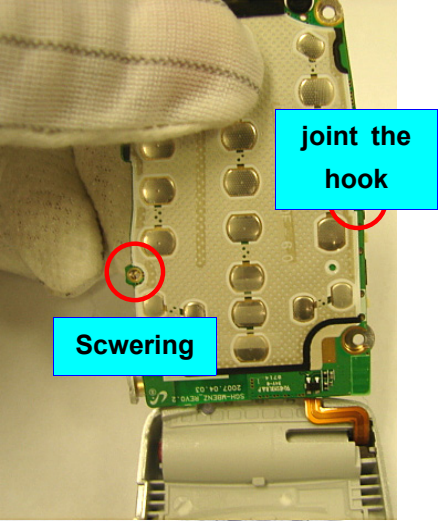
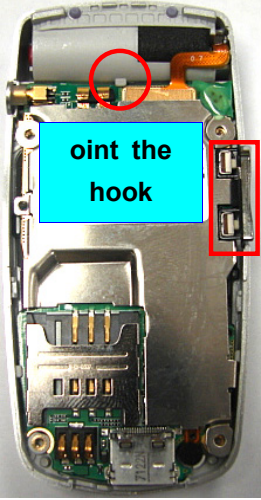
<p><b>5</b></p> 	<p><b>6</b></p> 
<p>1) Attach anti-dust TAPE 2) Let a KEY PAD on front assy.</p> <p><b>* caution</b></p> <p>1) Be care of Shooting out damage and scratch not to occur. 2) Pay attention not to damage for LCD FPCB.</p>	<p>1) Lock a LCD CONNECTOR to PBA <b>* caution</b></p> <p>1) Assemble the LCD connect horizontally. 2) Pay attention not to damage for LCD FPCB.</p>
<p><b>7</b></p> 	<p><b>8</b></p> 
<p>1) Joint the shield can right hook and hole of the B'd. 2) Scwering the left hall of the B'd.</p> <p><b>* caution</b></p> <p>1) Pay attention not to damage for LCD FPCB.</p>	<p>1) Joint the FRONT upper hook and B'd and arrange the B'd, FRONT. 2) Attach the Volume Key.</p> <p><b>* caution</b></p> <p>1) Pay attention not to damage for LCD FPCB. 2) Confirm B'd is attached completely on the FRONT.</p>

9



**Joint REAR case and FRONT case.**

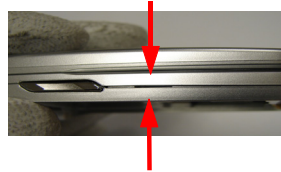

- 1) As below picture, joint the REAR upper and FRONT and ASS'Y.
  - 2) Joint the REAR case side, and then edge.
- ※ **caution**
- 1) Be care of Shooting out damage and scratch not to occur.

10



- 1) Screw 4 point on REAR assy'.
  - 2) Attach the RF COVER.
- ※ **caution**
- 1) Be care of Shooting out damage and scratch not to occur.

## 2-5. LCD KIT ASSEMBLING

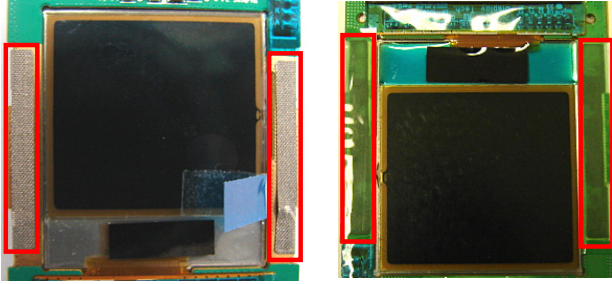
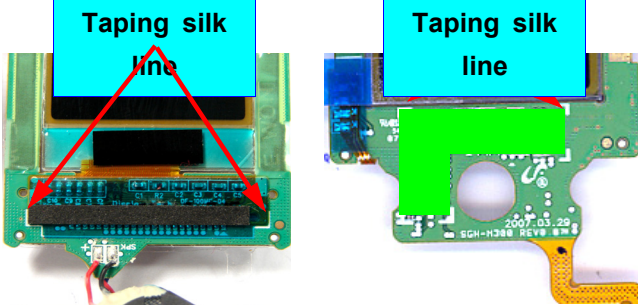
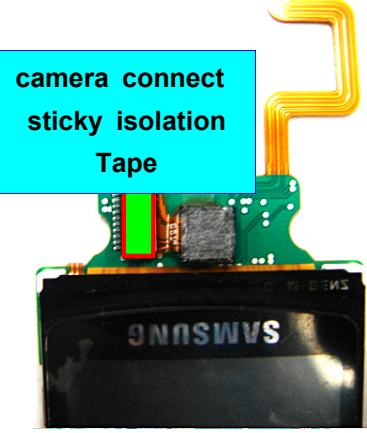
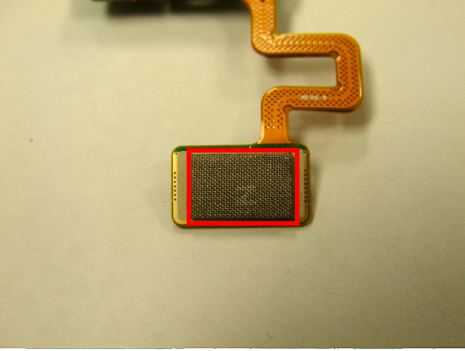
<p><b>1</b></p>  <p><b>Attach conductive Tape</b></p> <p><b>Attach isolation Tape</b></p>	<p><b>2</b></p>  <p><b>Taping silk line</b></p> <p><b>Taping silk line</b></p>
<p>1) Attach conduction tape on the left and right side of LCD.                  2) Attach isolation tape on the left and right side of LCD.                  ※ <b>caution</b>                  1) When you attach the tape, be careful of a base line of a picture.</p>	<p>1) Attach the SPONGE along the line.                  2) Attach the isolation tape along the line.                  ※ <b>caution</b>                  1) When you attach the tape, be careful of a base line of a picture.</p>
<p><b>3</b></p>  <p><b>camera connect sticky isolation Tape</b></p>	<p><b>4</b></p> 
<p>1) Attach CAMERA CONNECTOR sticky isolation tape.                  ※ <b>caution</b>                  1) When you attach the tape, be careful of a base line of a picture.</p>	<p>1) Attach the GASKET on the LCD CONNECTOR                  ※ <b>caution</b>                  1) When you attach the tape, be careful of a base line of a picture.                  (Tape should be in the LCD connect.)</p>

### 3. Flow Chart of Troubleshooting

#### 3-1. Baseband

##### 3-1-1. Power ON

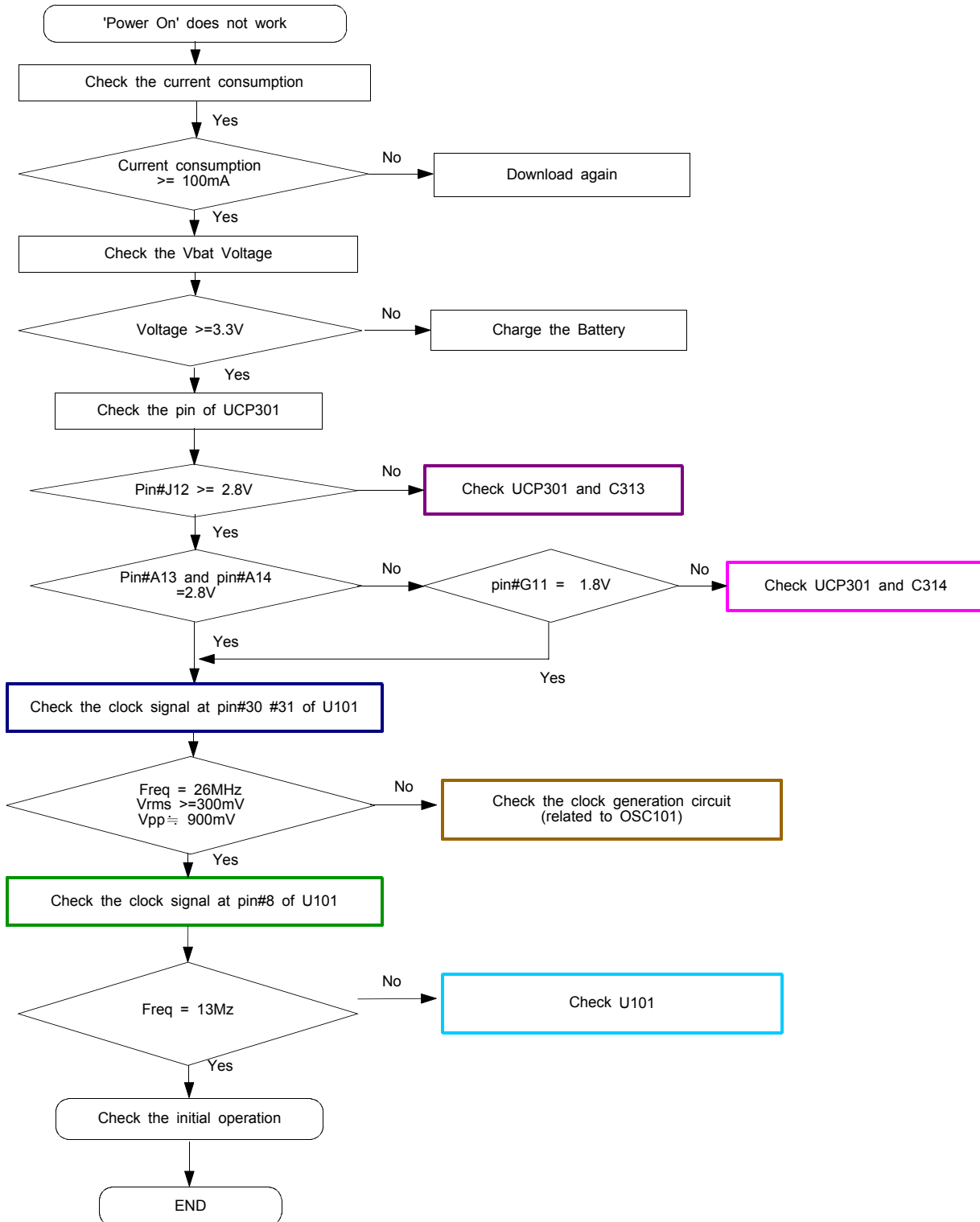



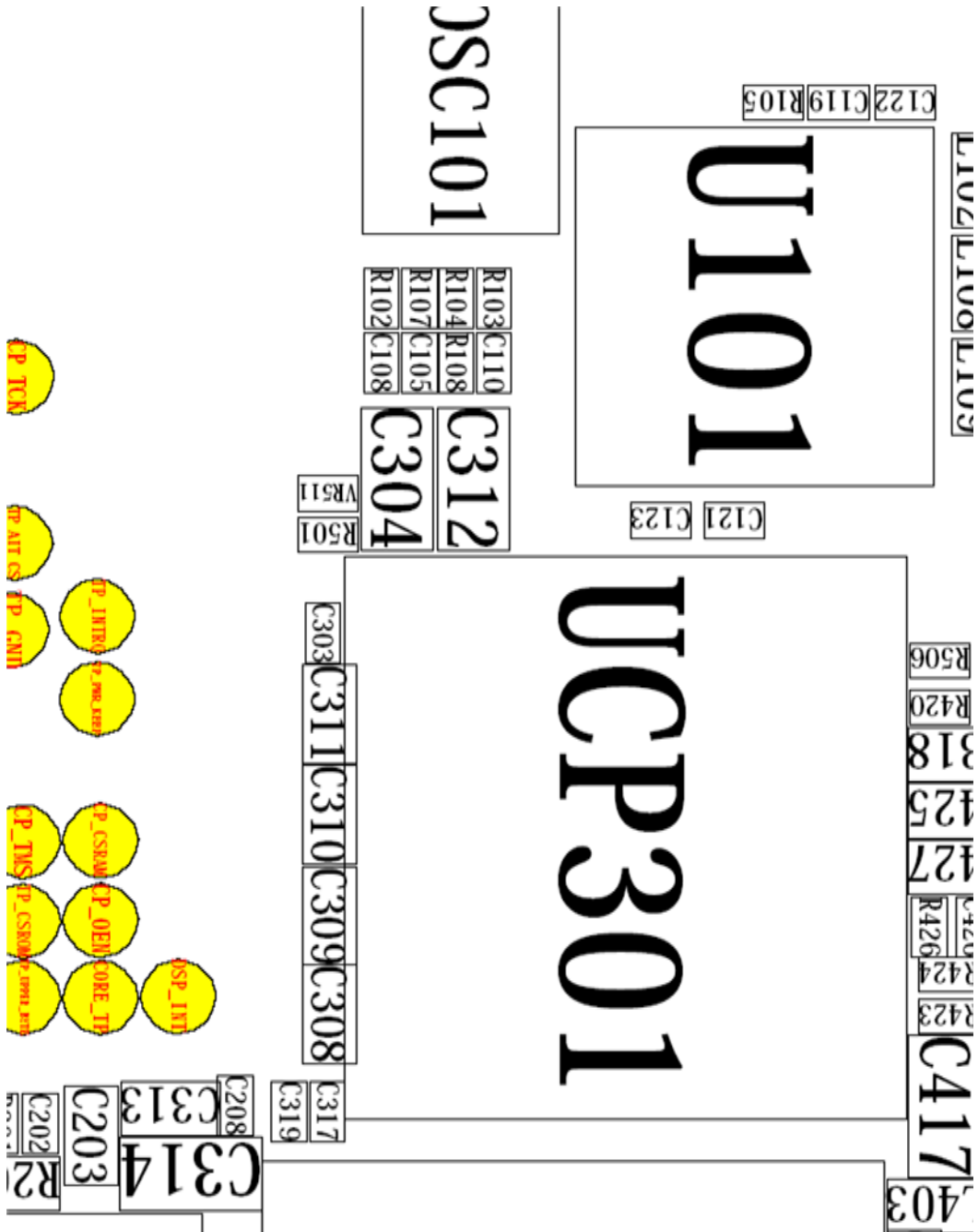

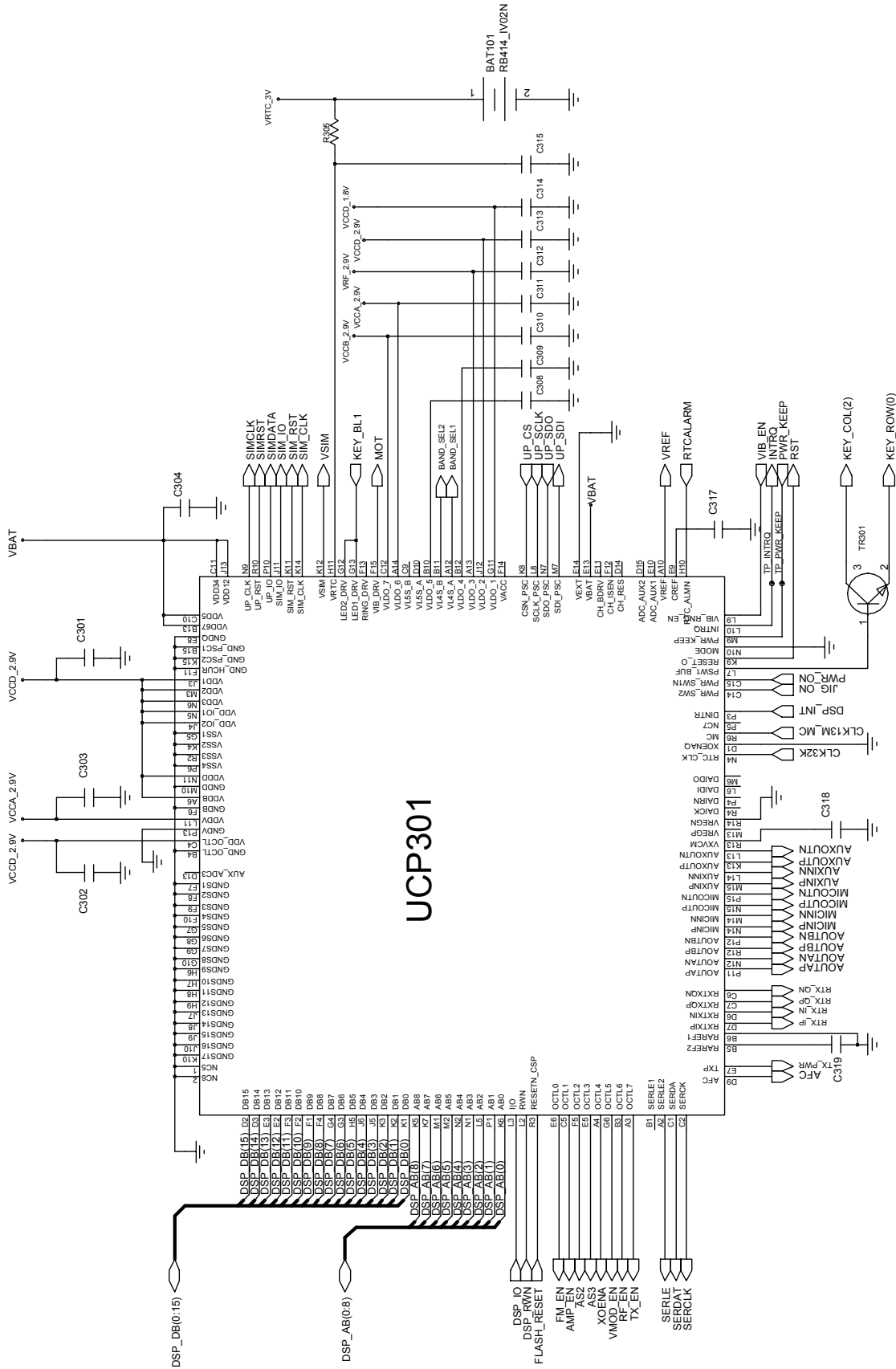

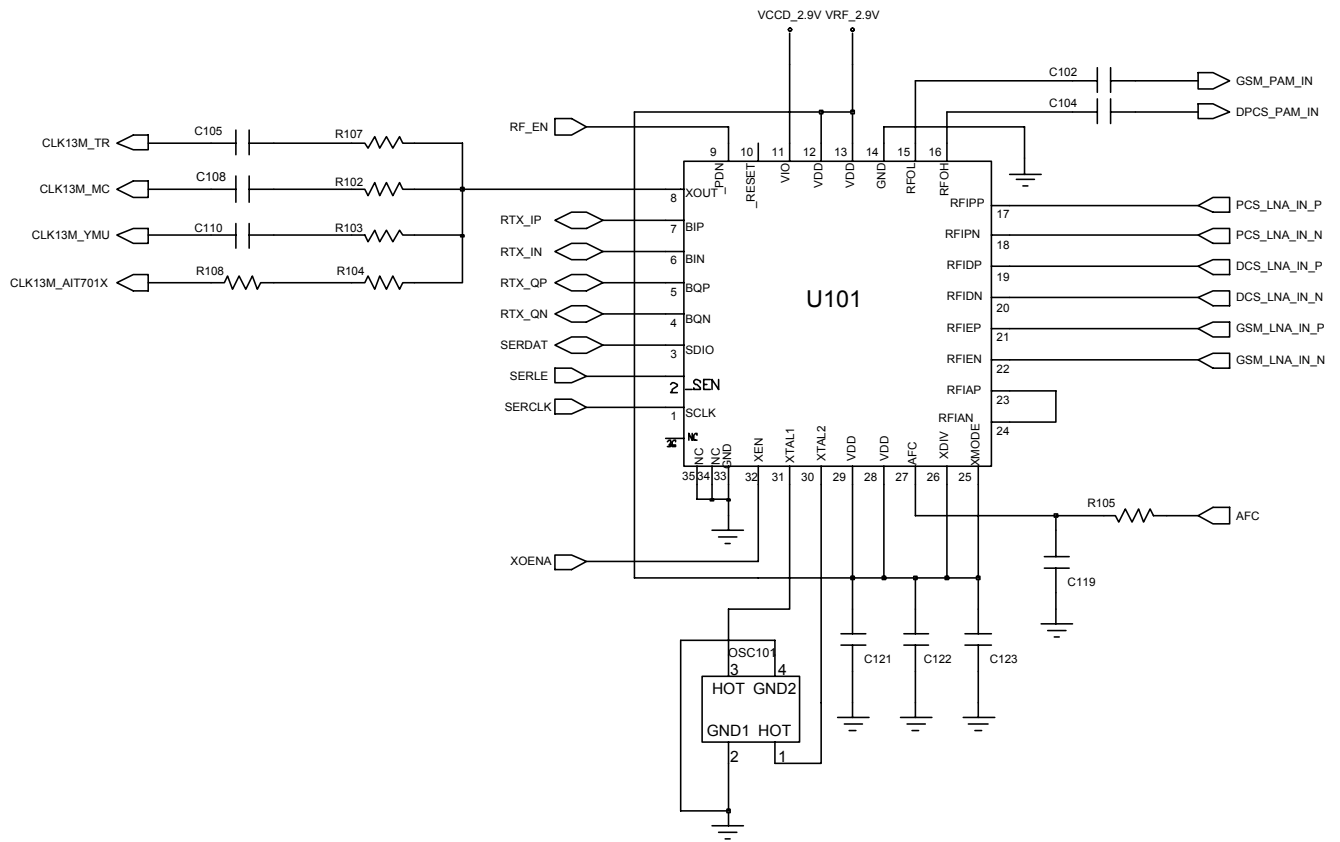

### 3-1-2. Initial

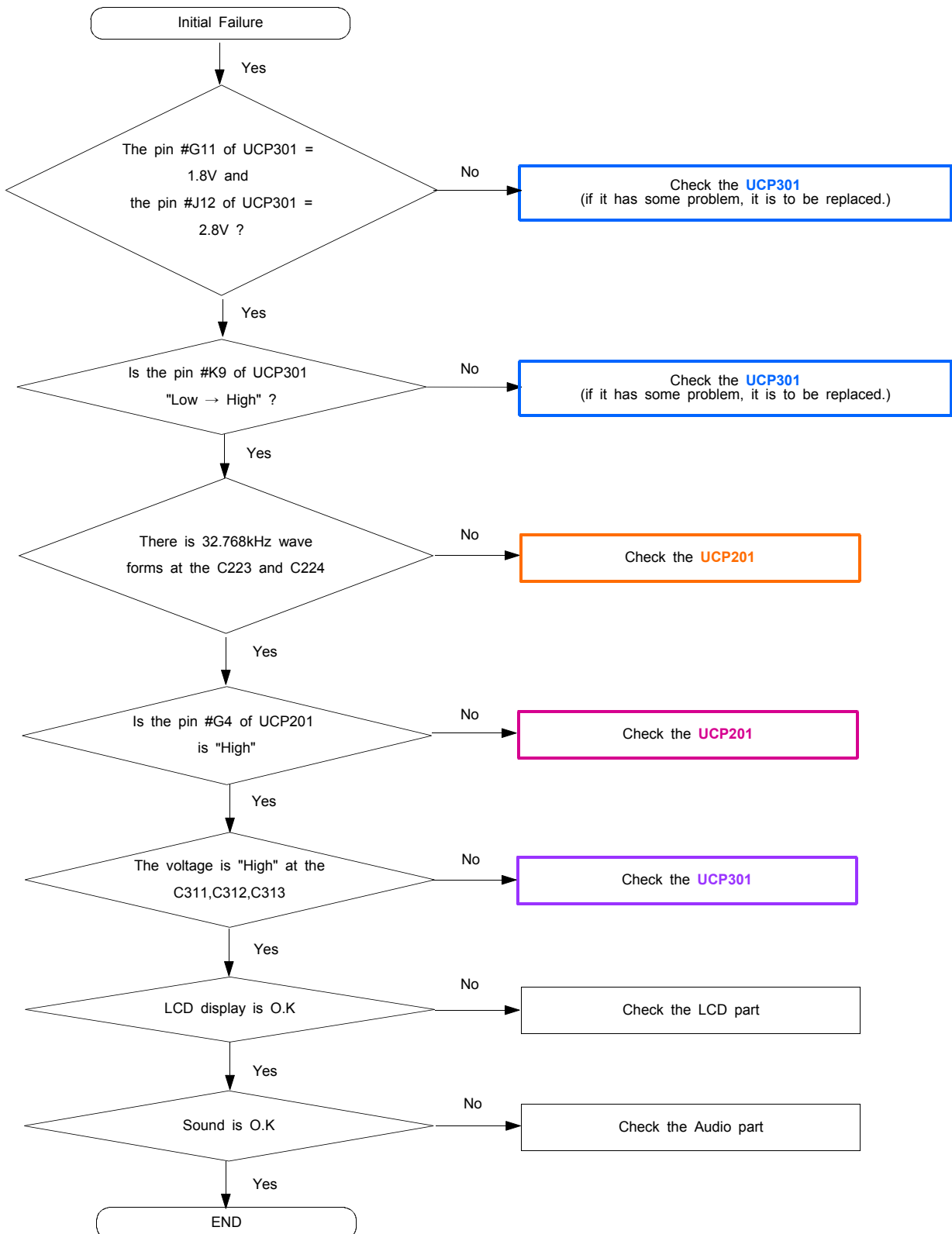

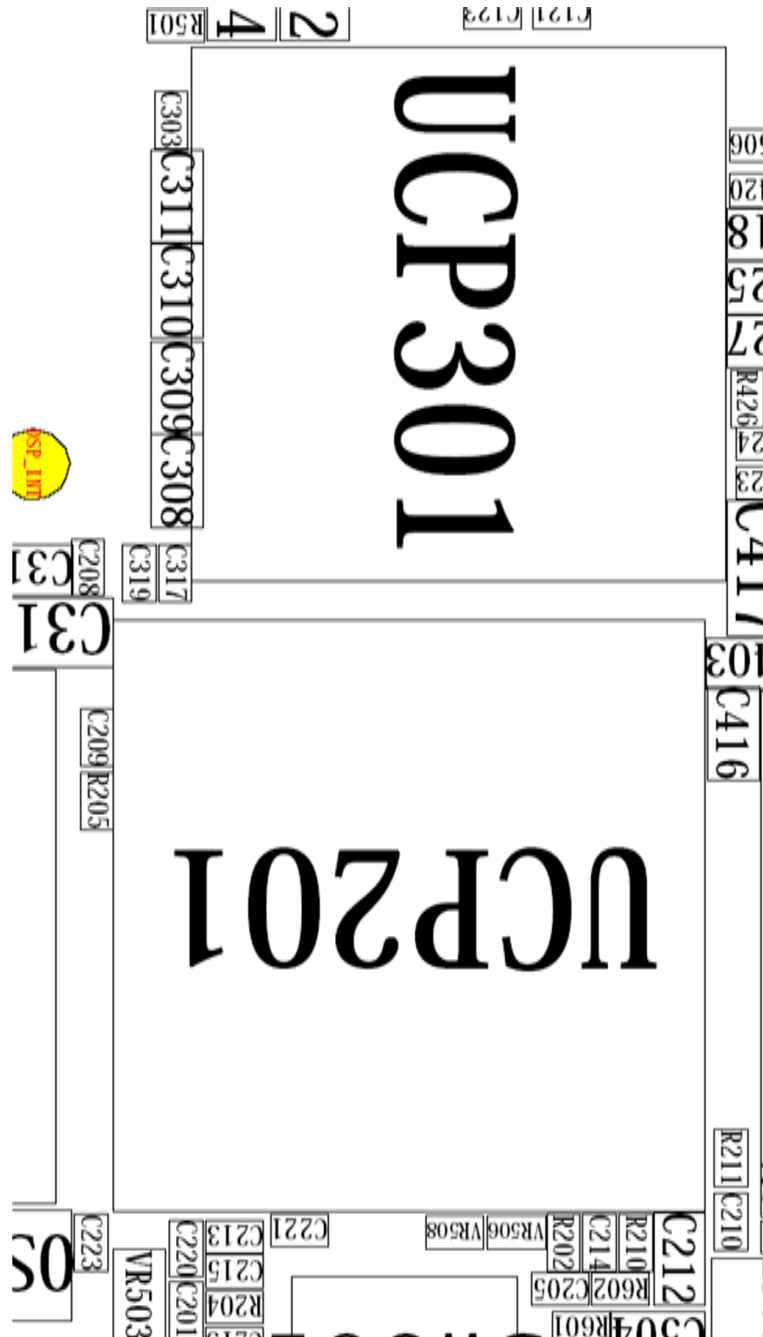

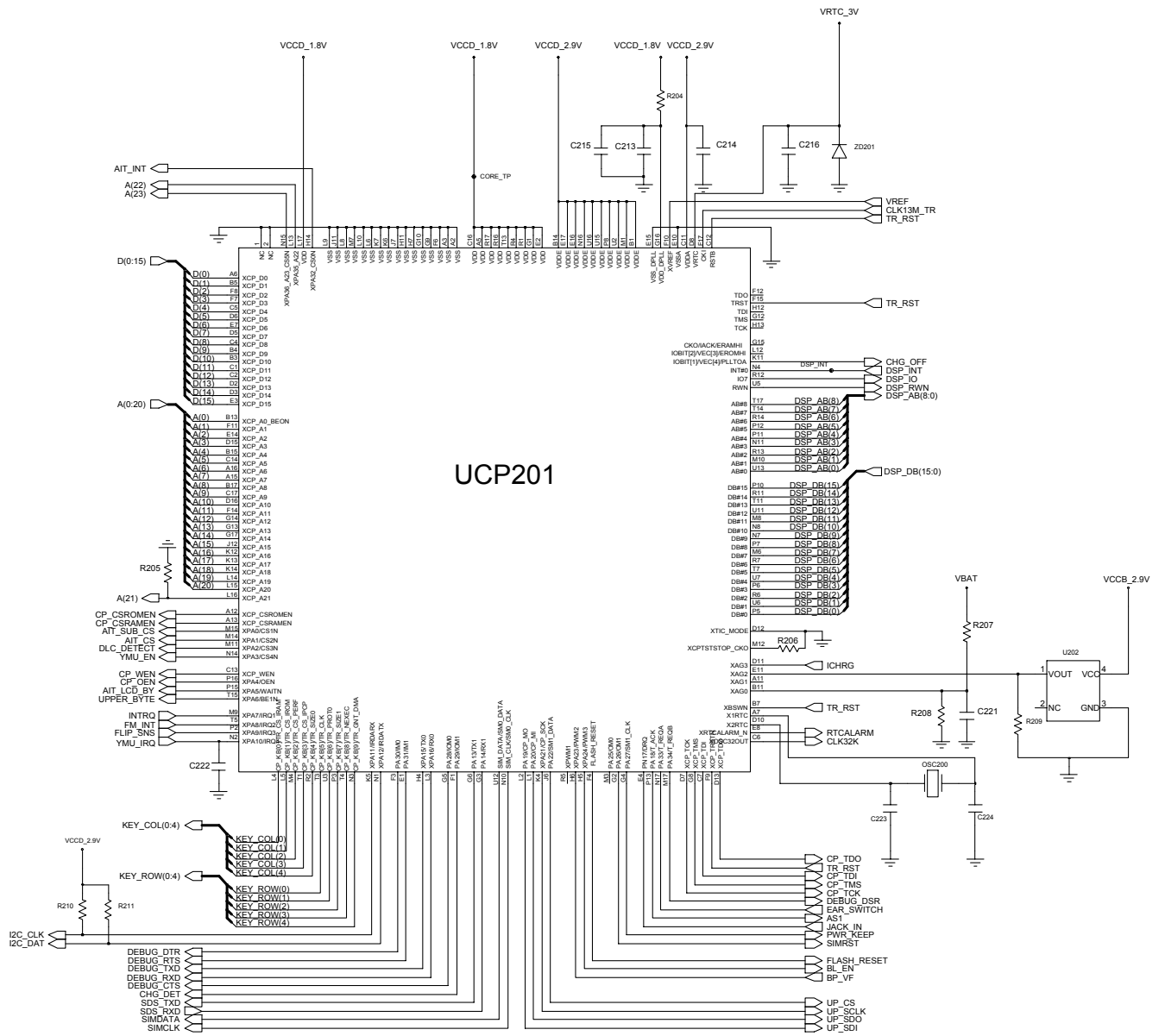

### 3-1-3. Sim Part

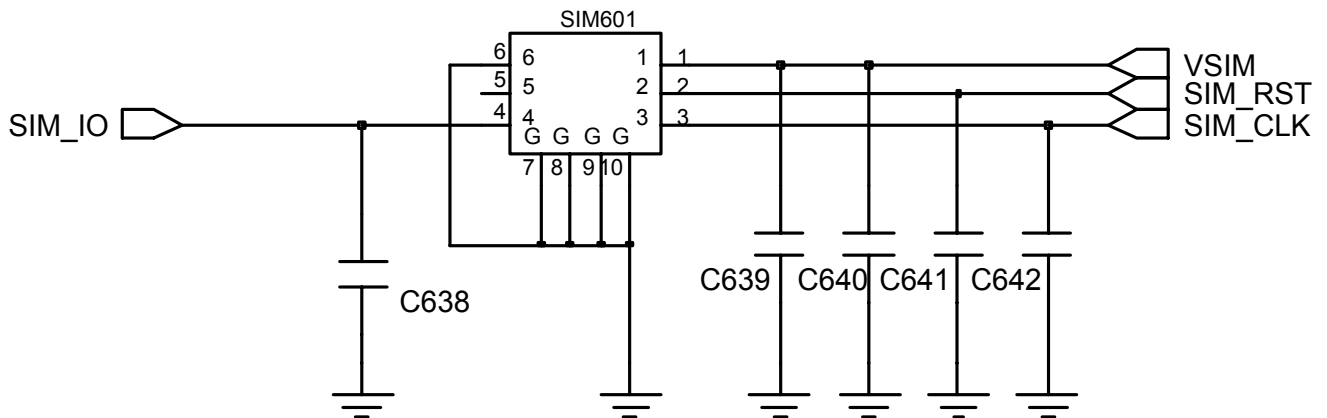
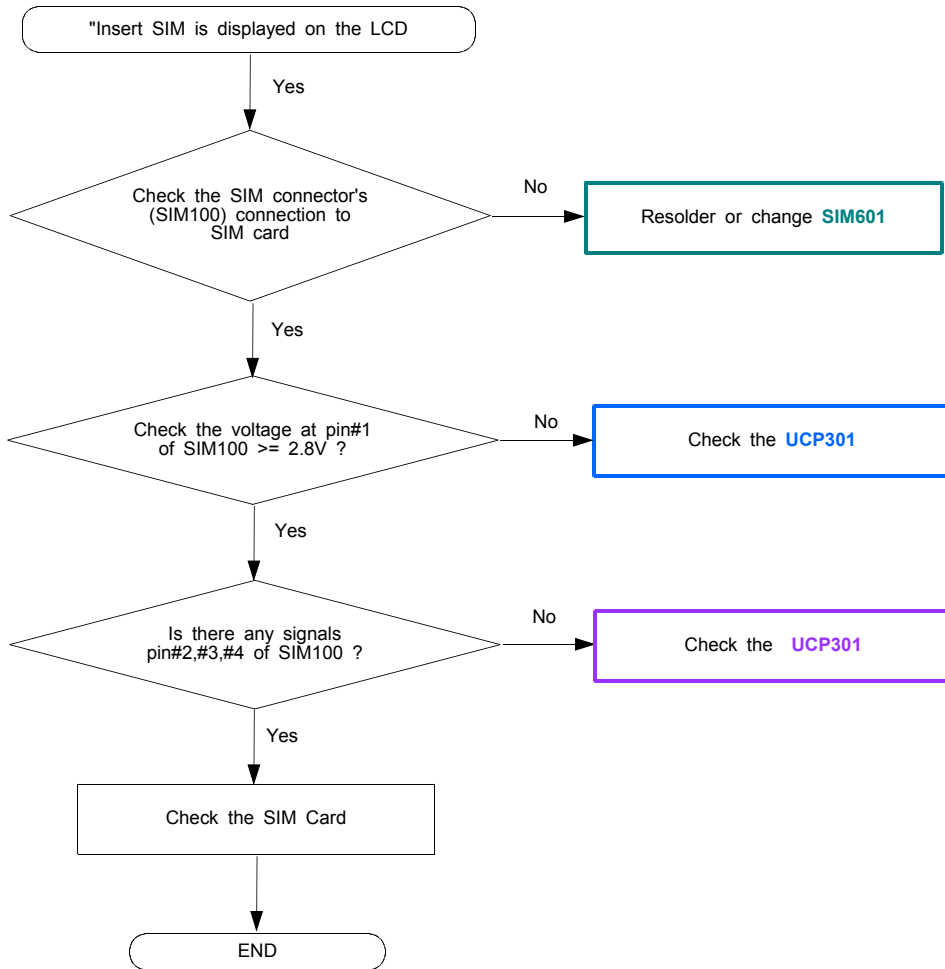

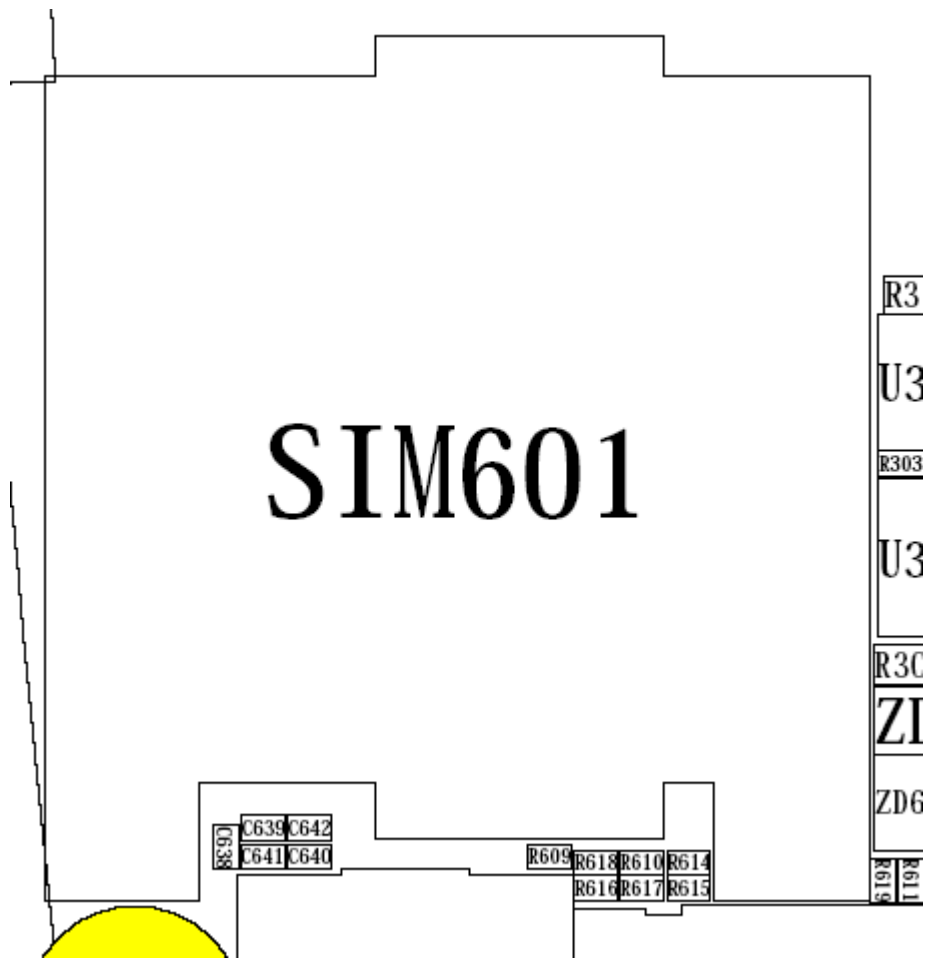
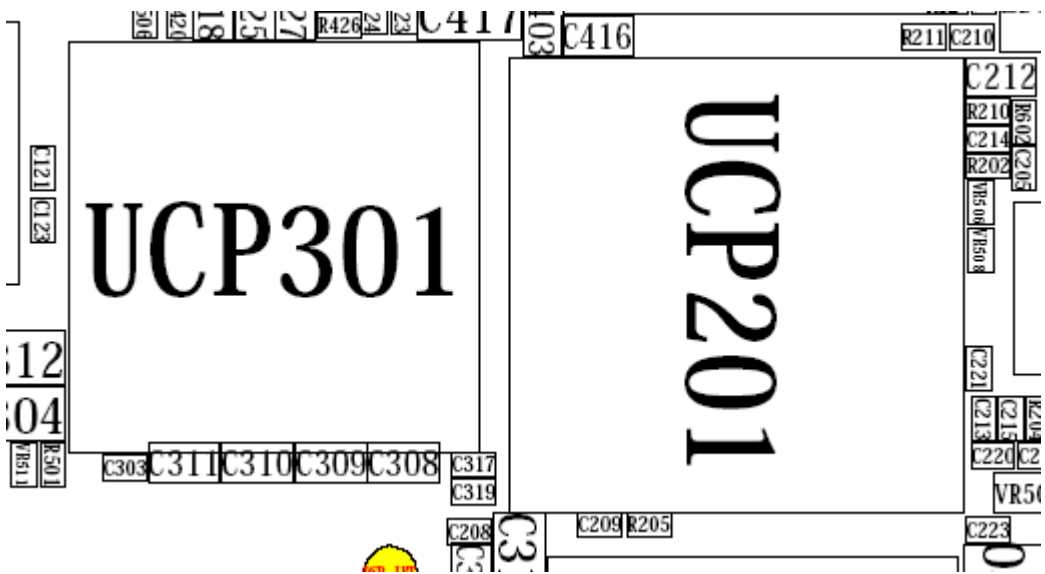



### 3-1-4. Microphone Part

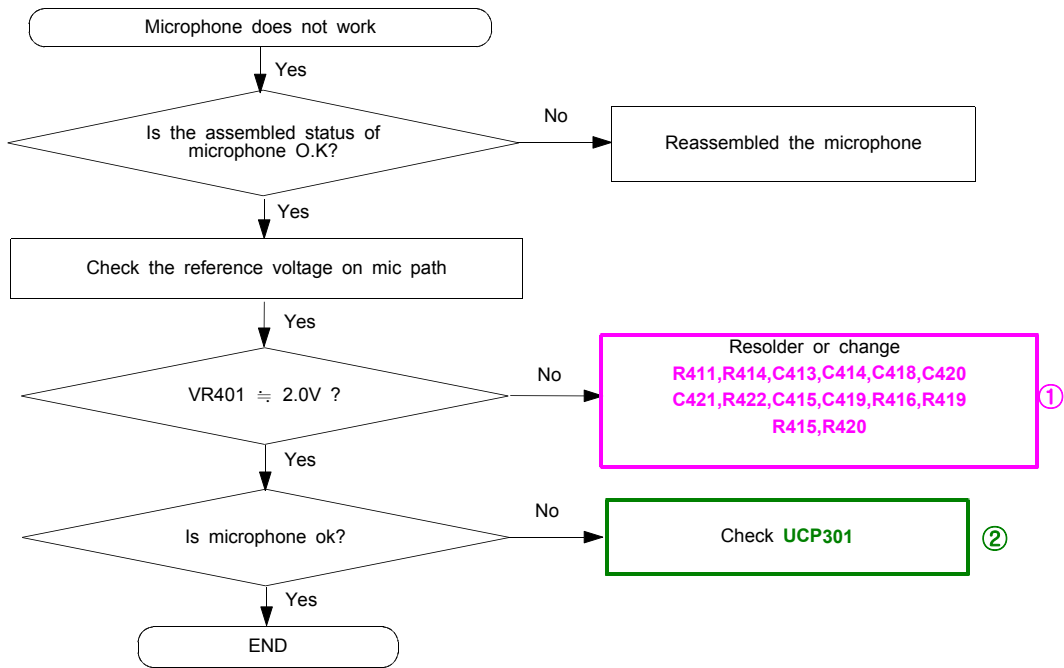

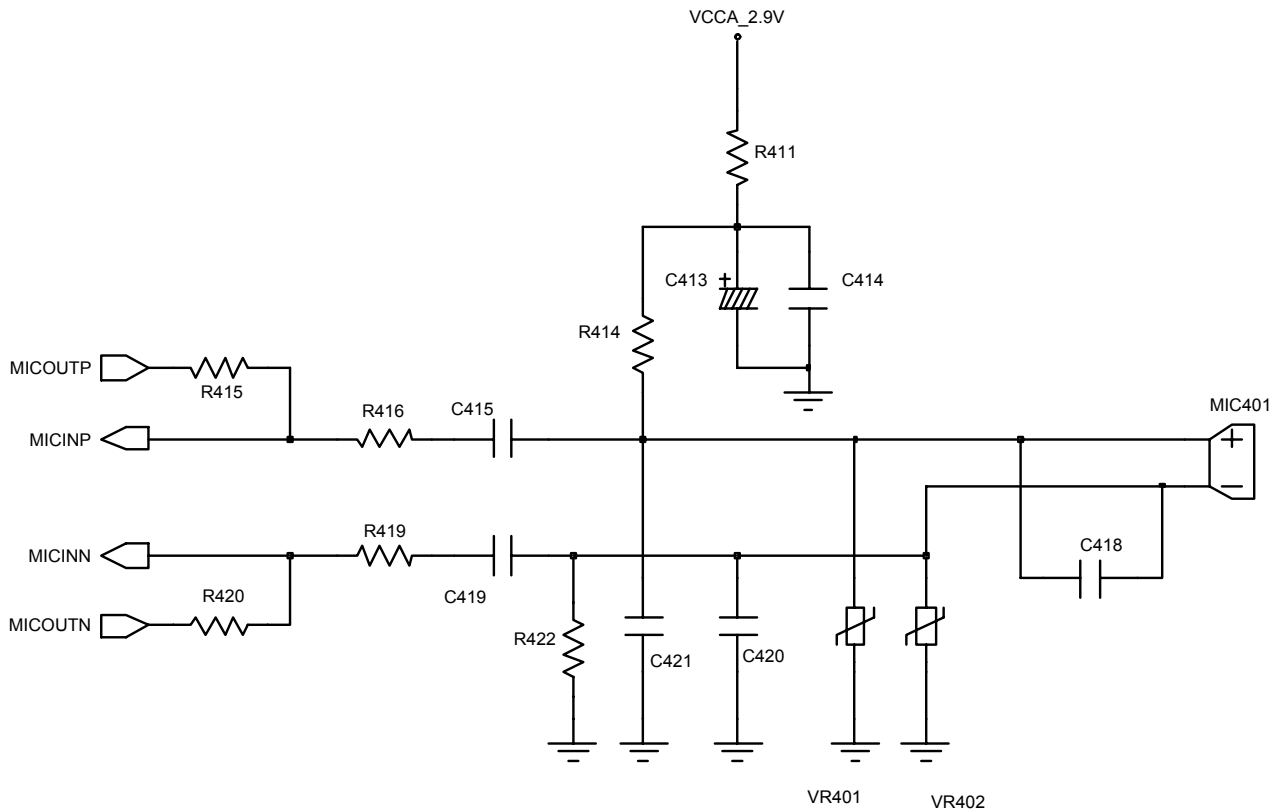
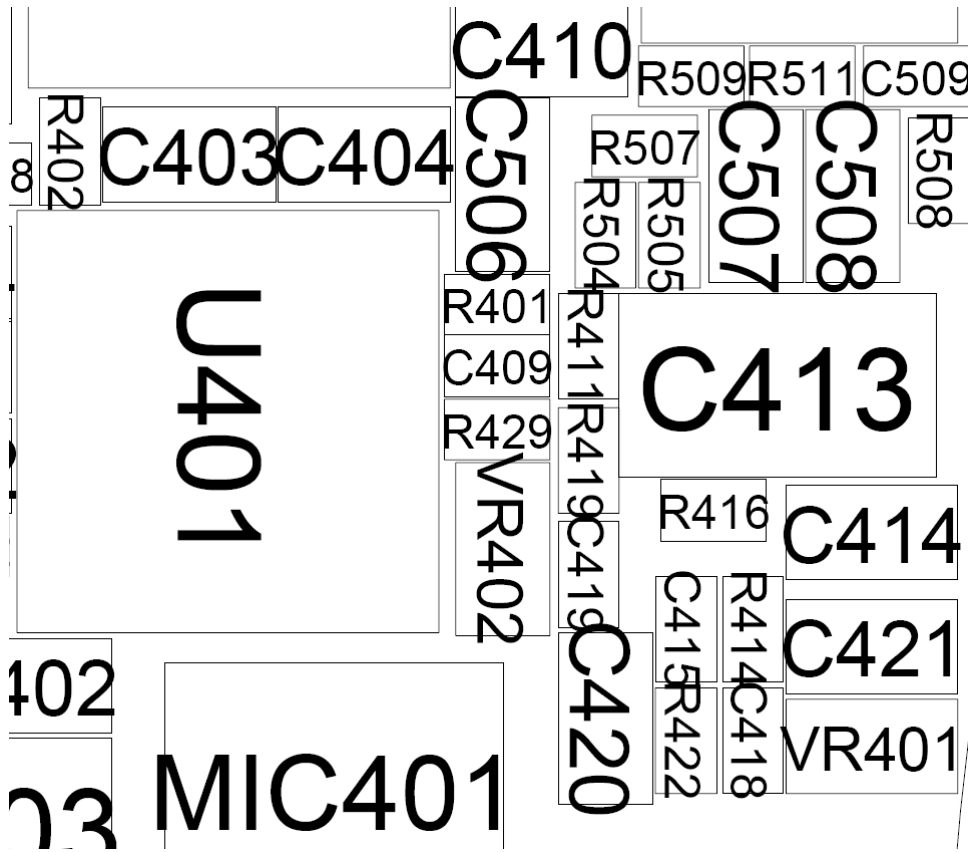

### 3-1-5. Receiver Part

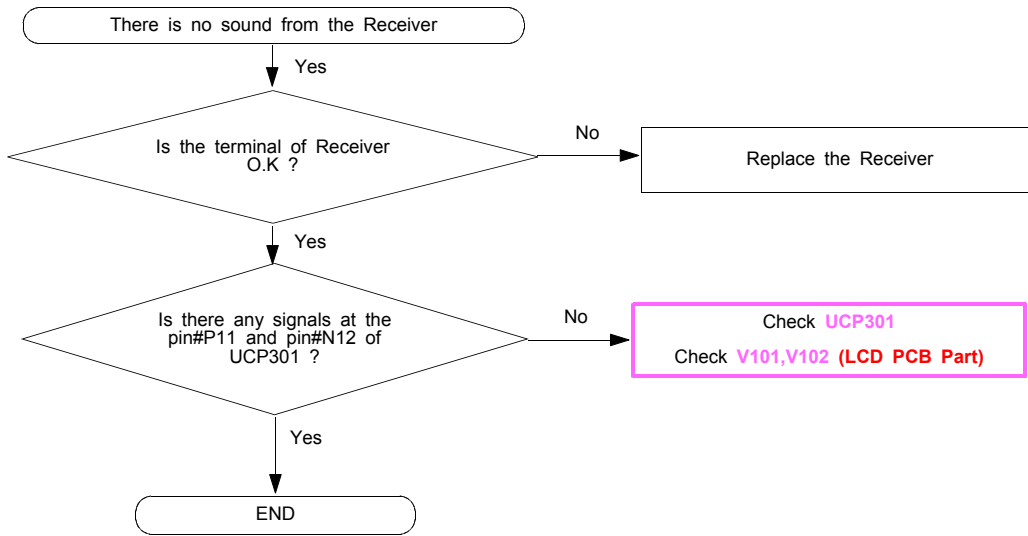

### 3-1-6. Speaker Part

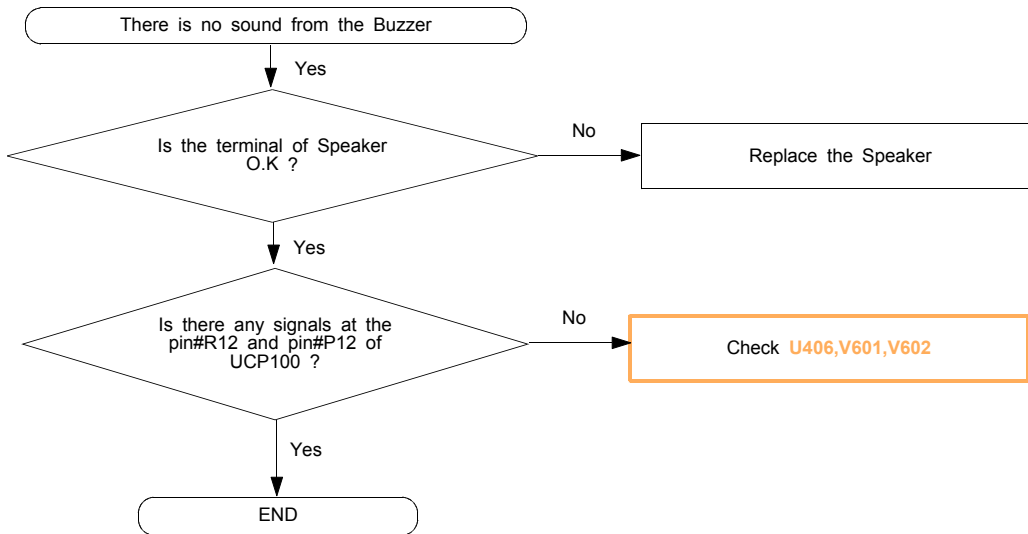

< LCD PCB Part >

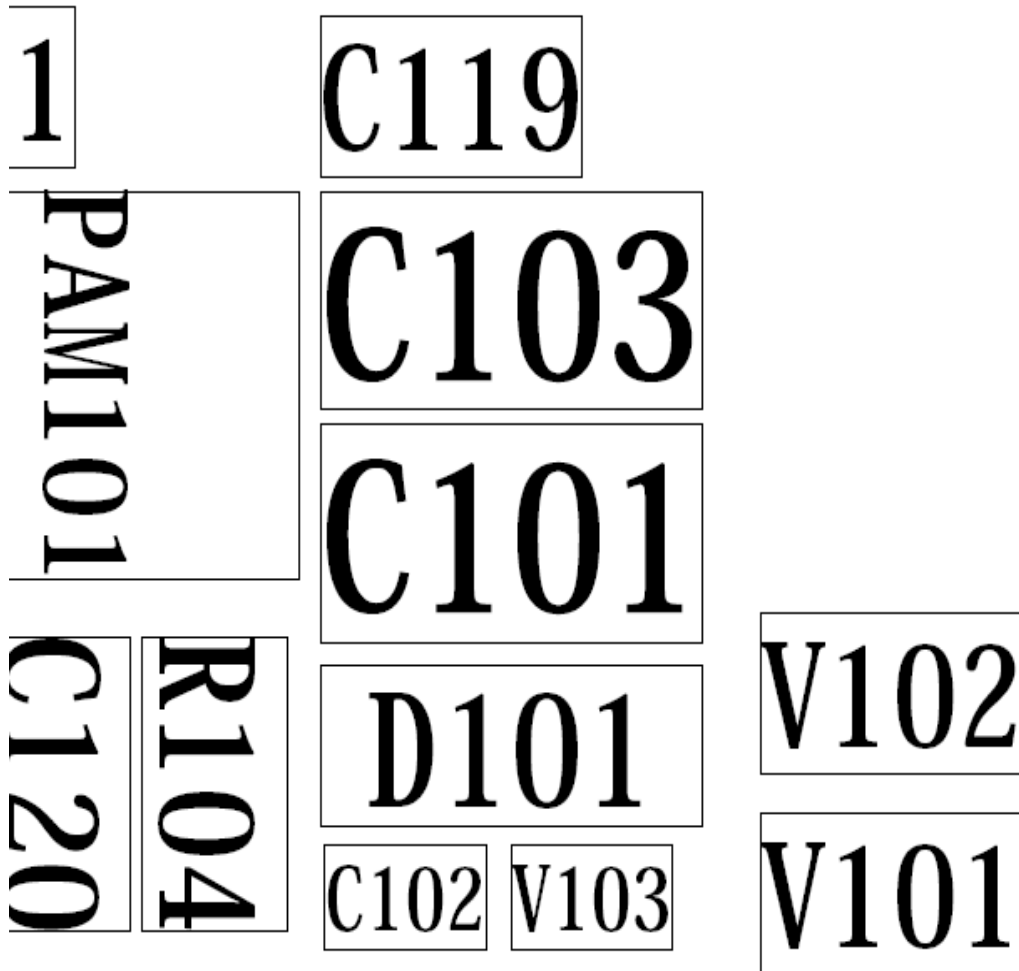

### 3-2.RF

#### 3-2-1. EGSM RX

CONTINUOUS RX ON  
RF INPUT : 62CH  
AMP : -50dBm

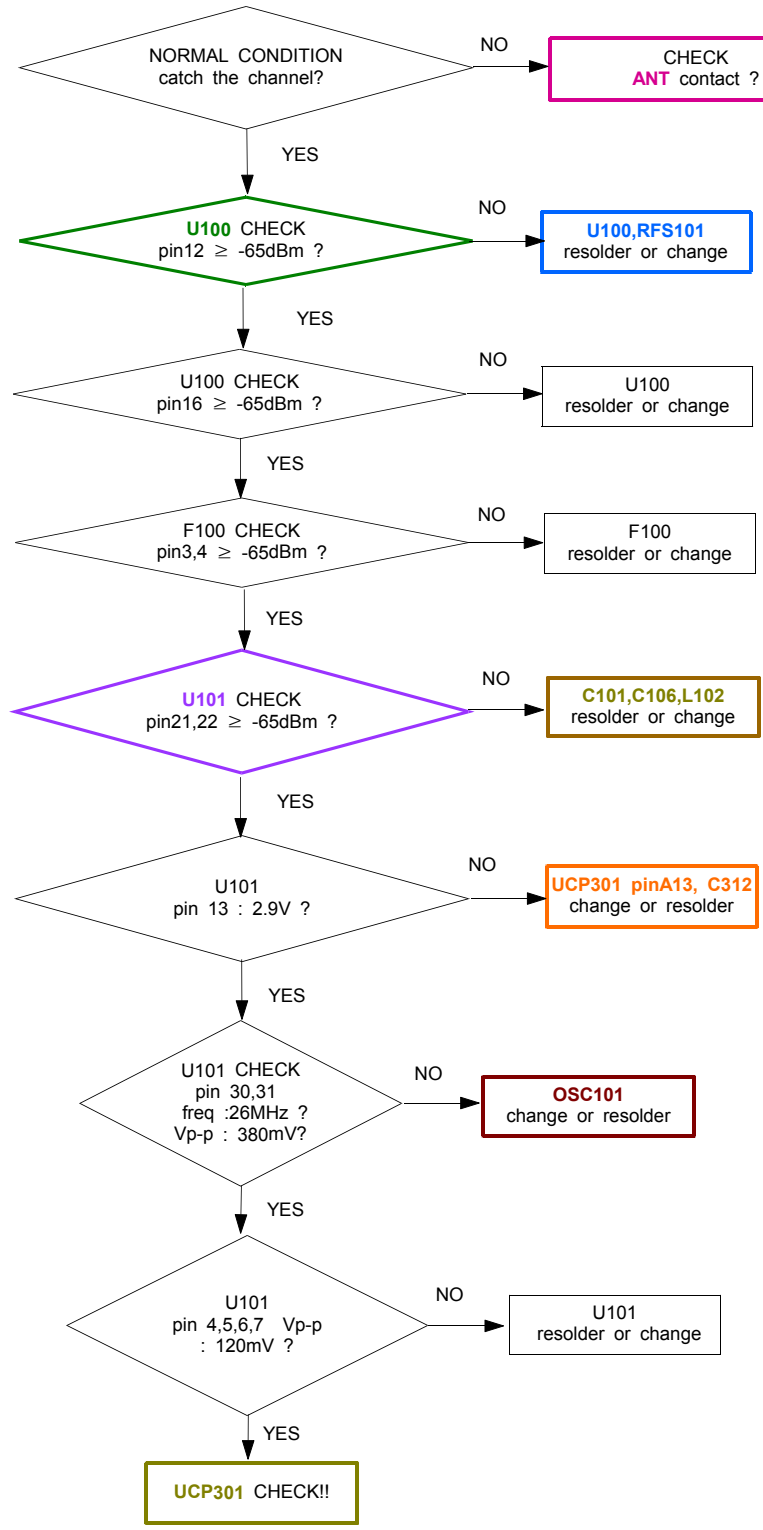

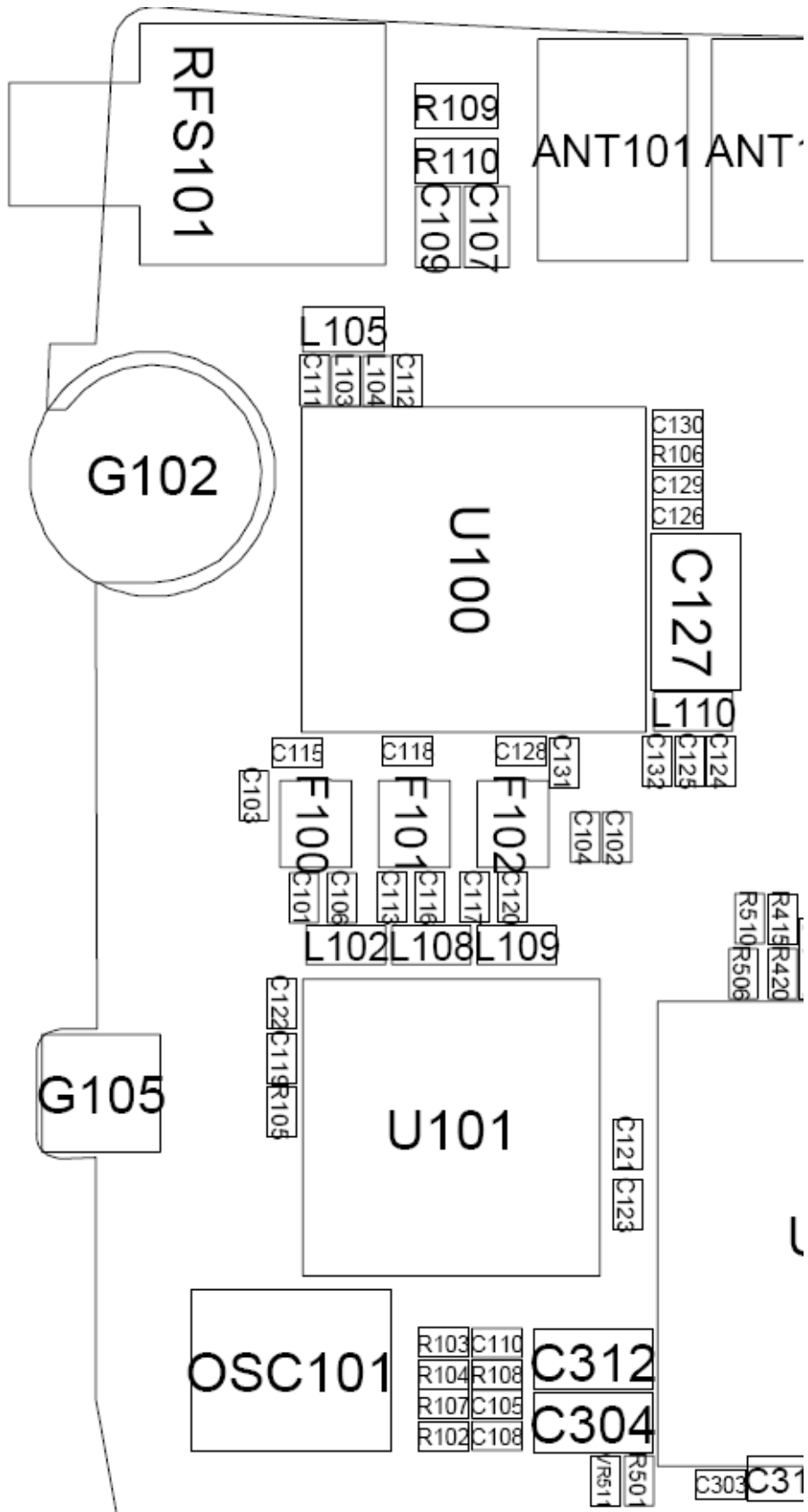

3-2-2. DCS RX

CONTINUOUS RX ON  
RF INPUT : 698CH  
AMP : -50dBm

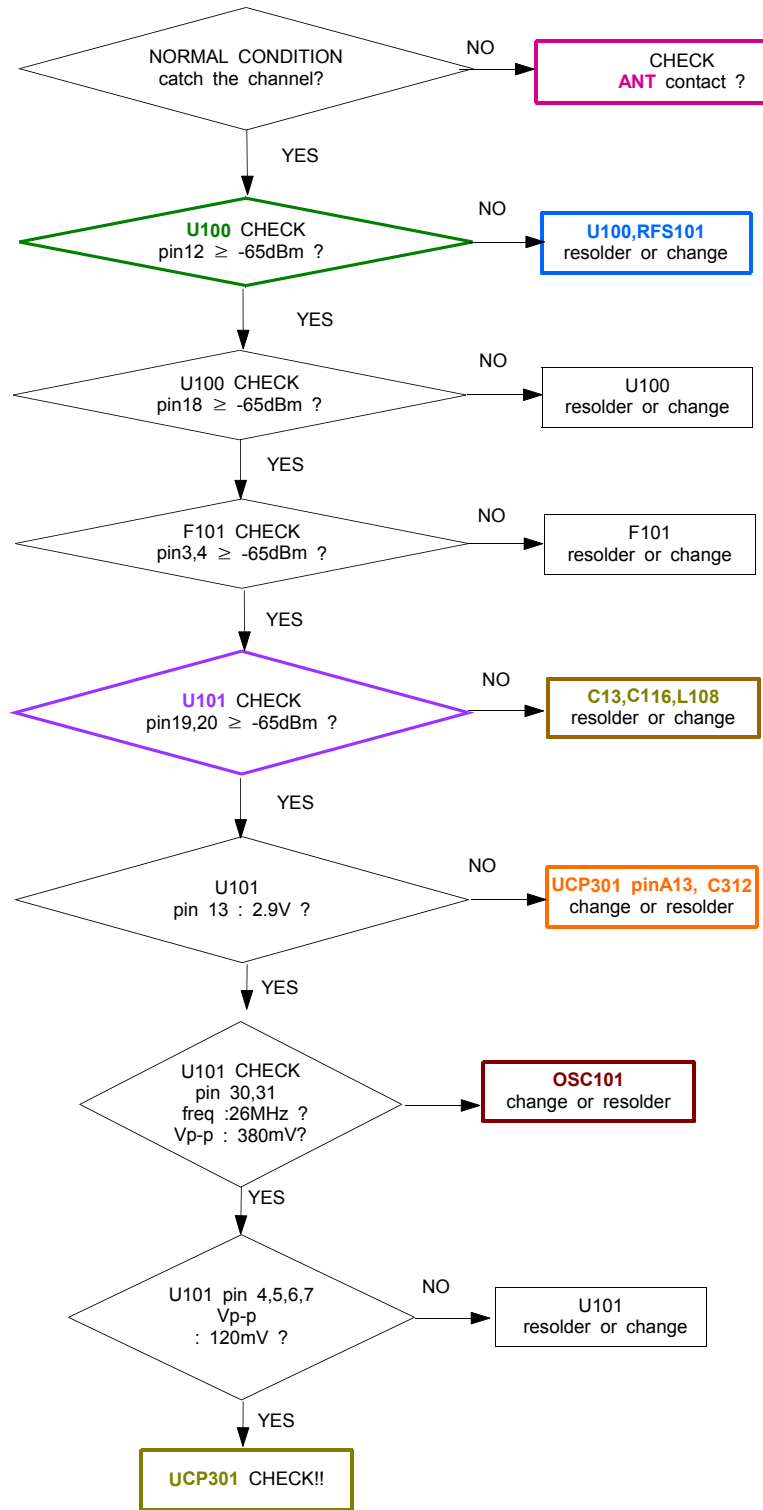

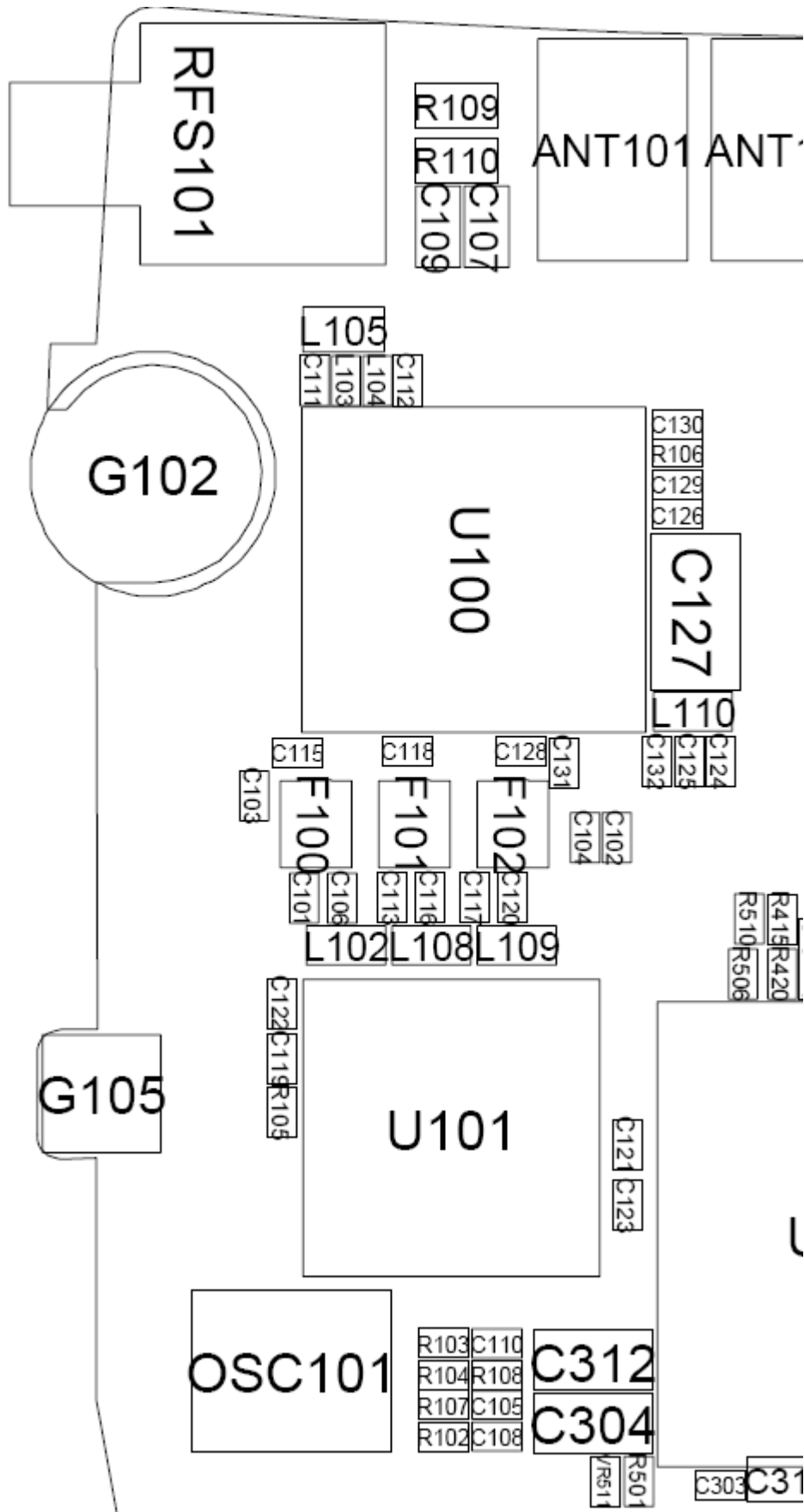



### 3-2-3. EGSM TX

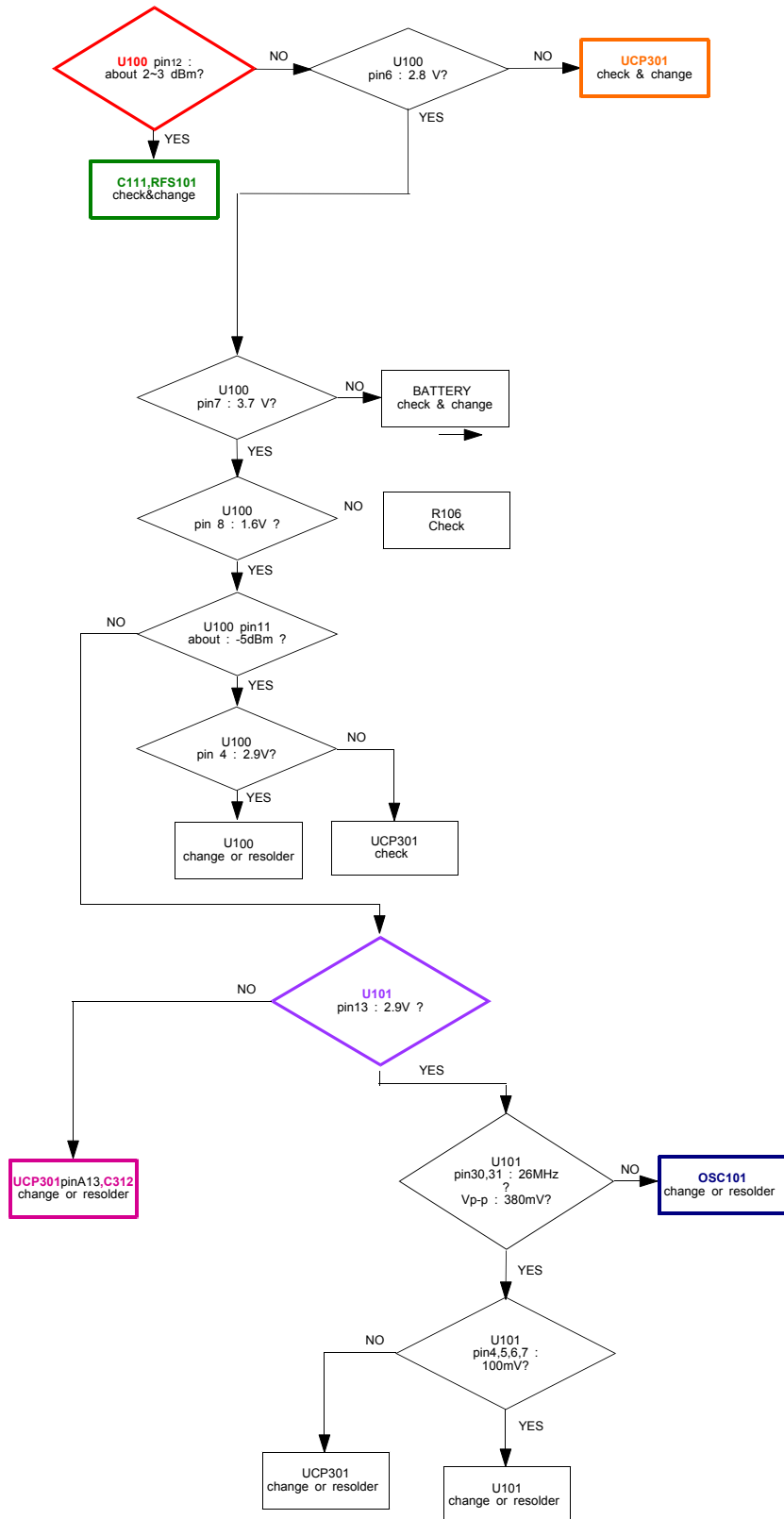

CONTINUOUS TX ON CONDITION  
 TX POWER DAC: 600 CODE APPLIED  
 CH : 62  
 RBW : 100KHz  
 VBW : 100KHz  
 SPAN : 10MHz  
 REF LEV : 10dBm  
 ATT : 20dB

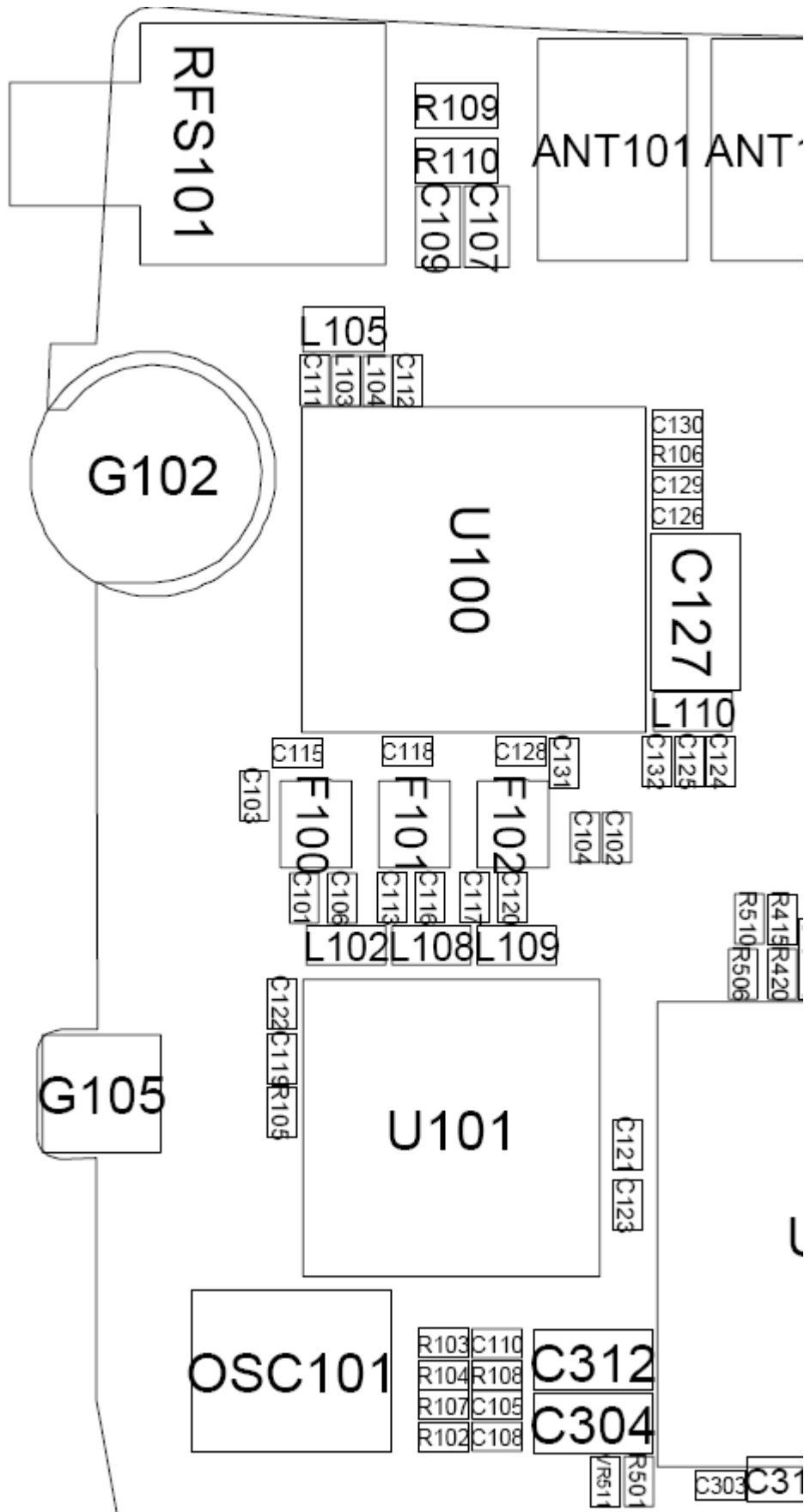

3-2-4. DCS TX

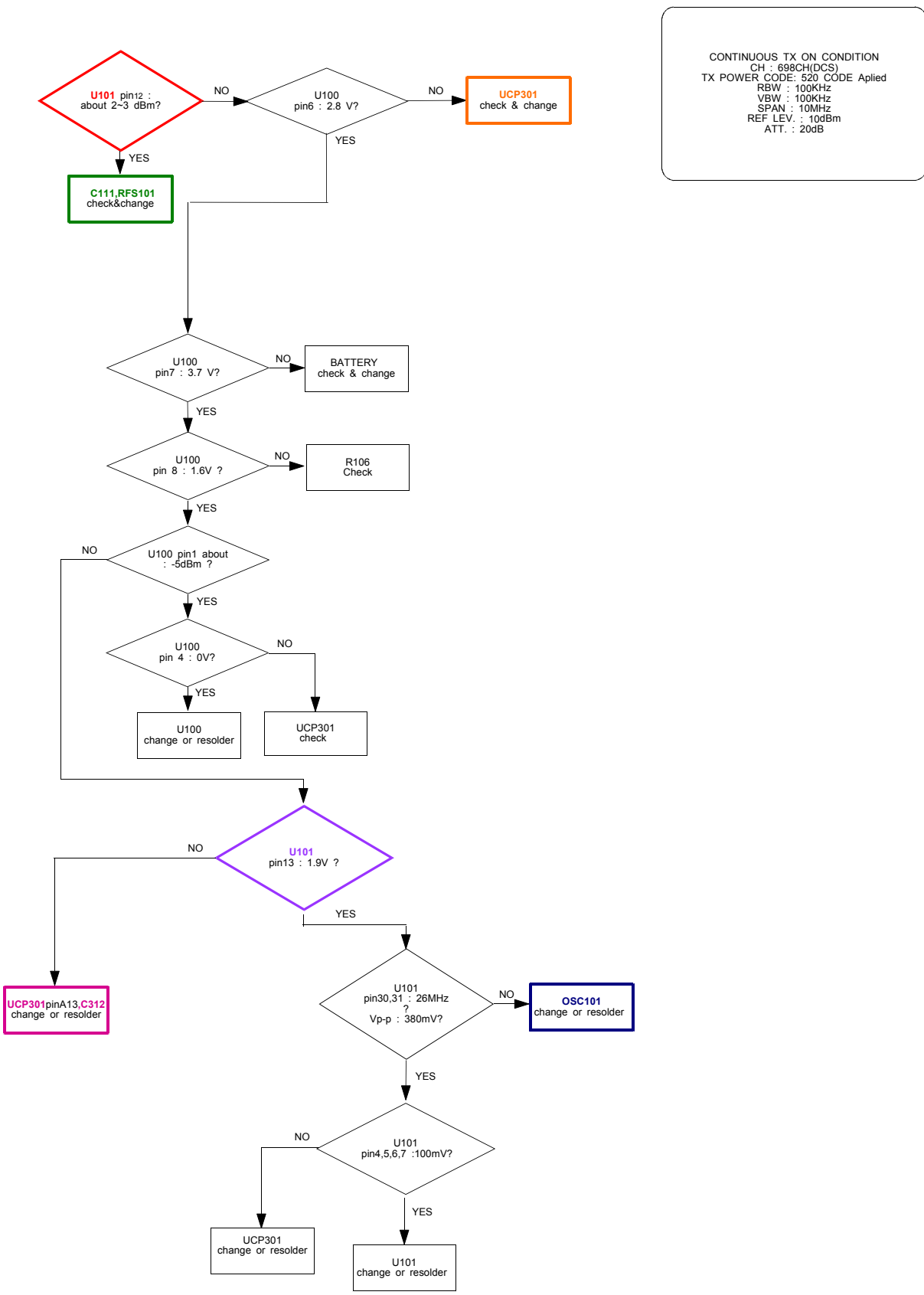

CONTINUOUS TX ON CONDITION  
 CH : 698CH(DCS)  
 TX POWER CODE: 520 CODE Applied  
 RBW : 100KHz  
 VBW : 100KHz  
 SPAN : 10MHz  
 REF LEV. : 10dBm  
 ATT. : 20dB

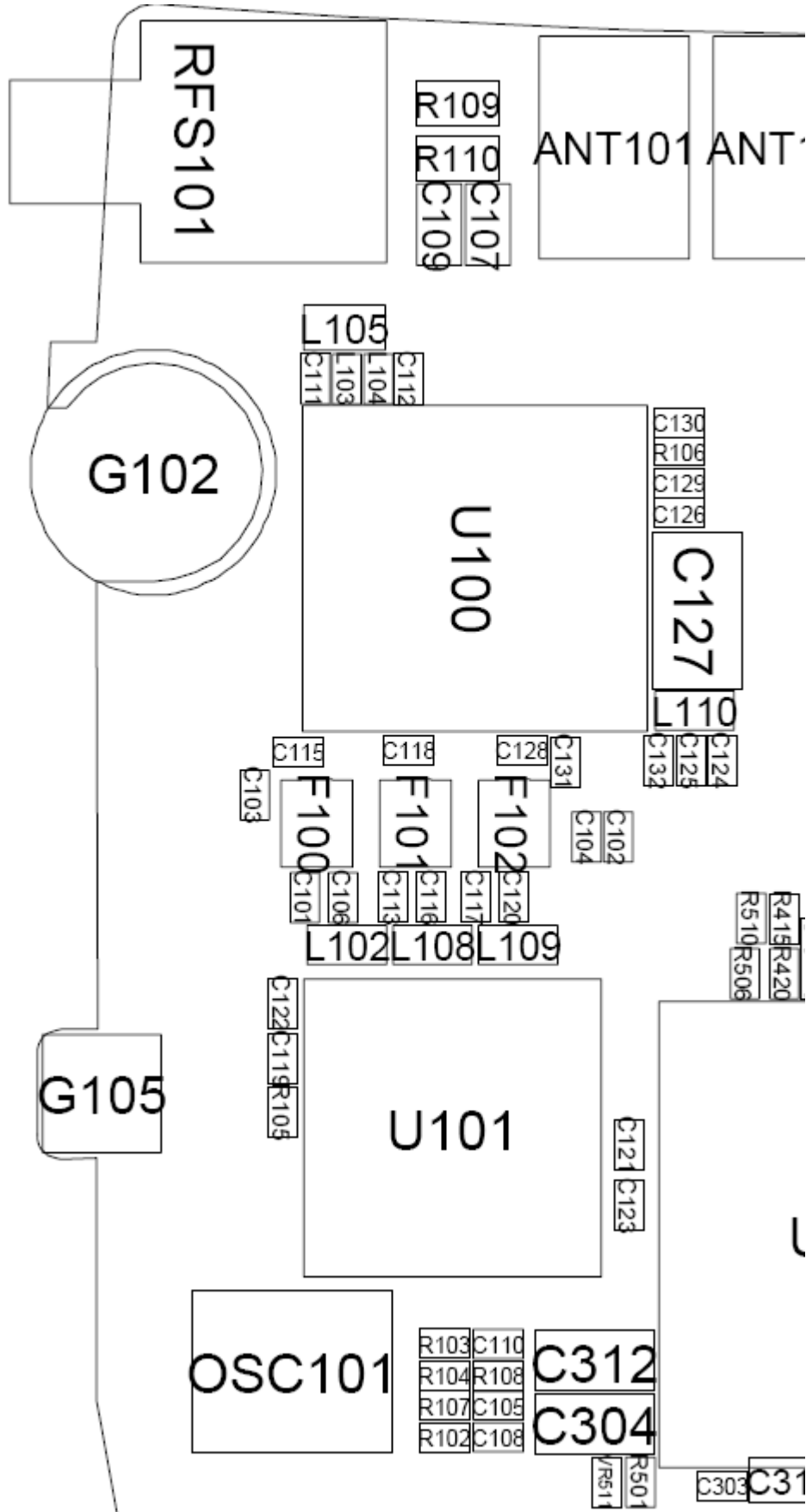

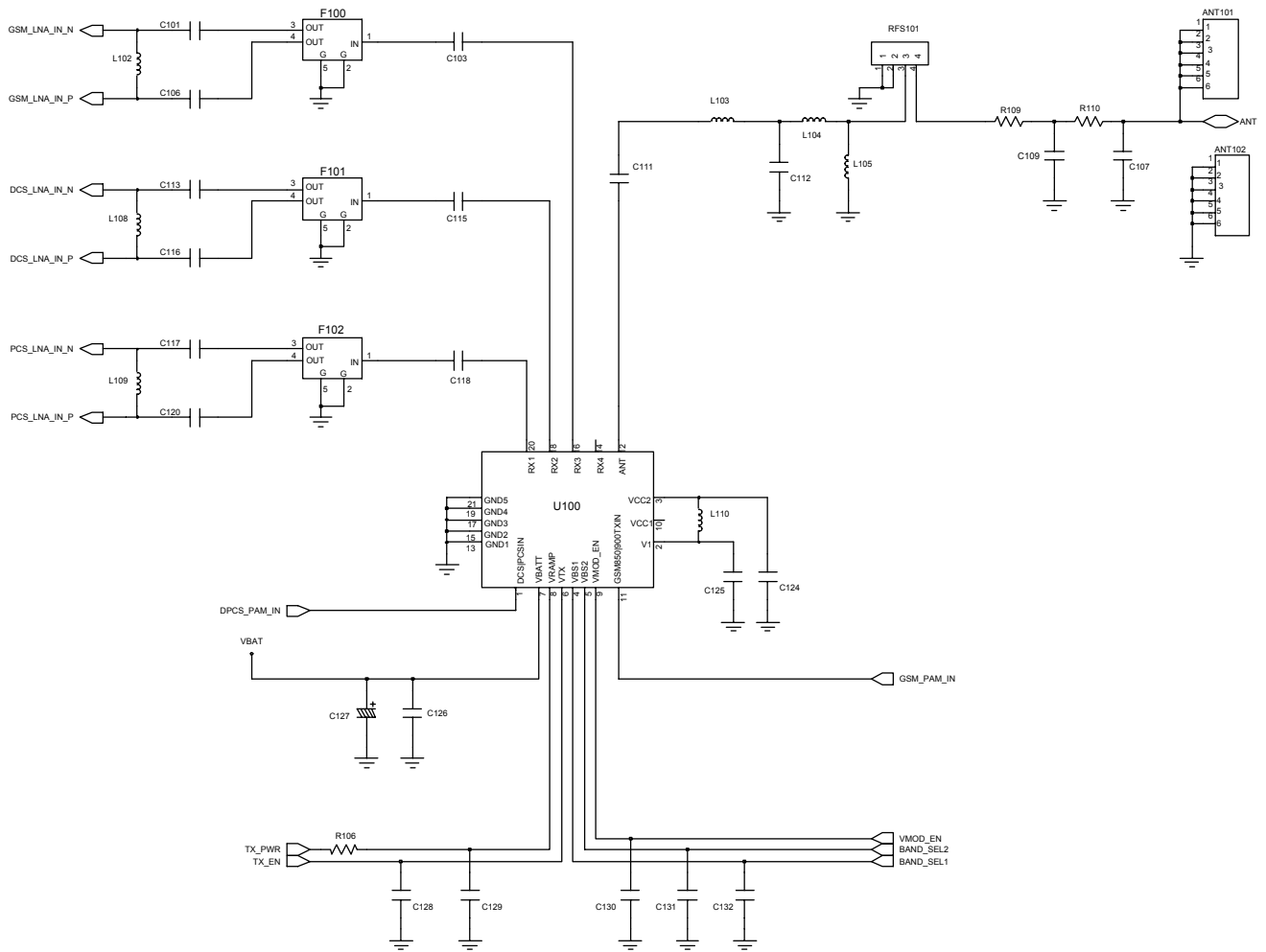

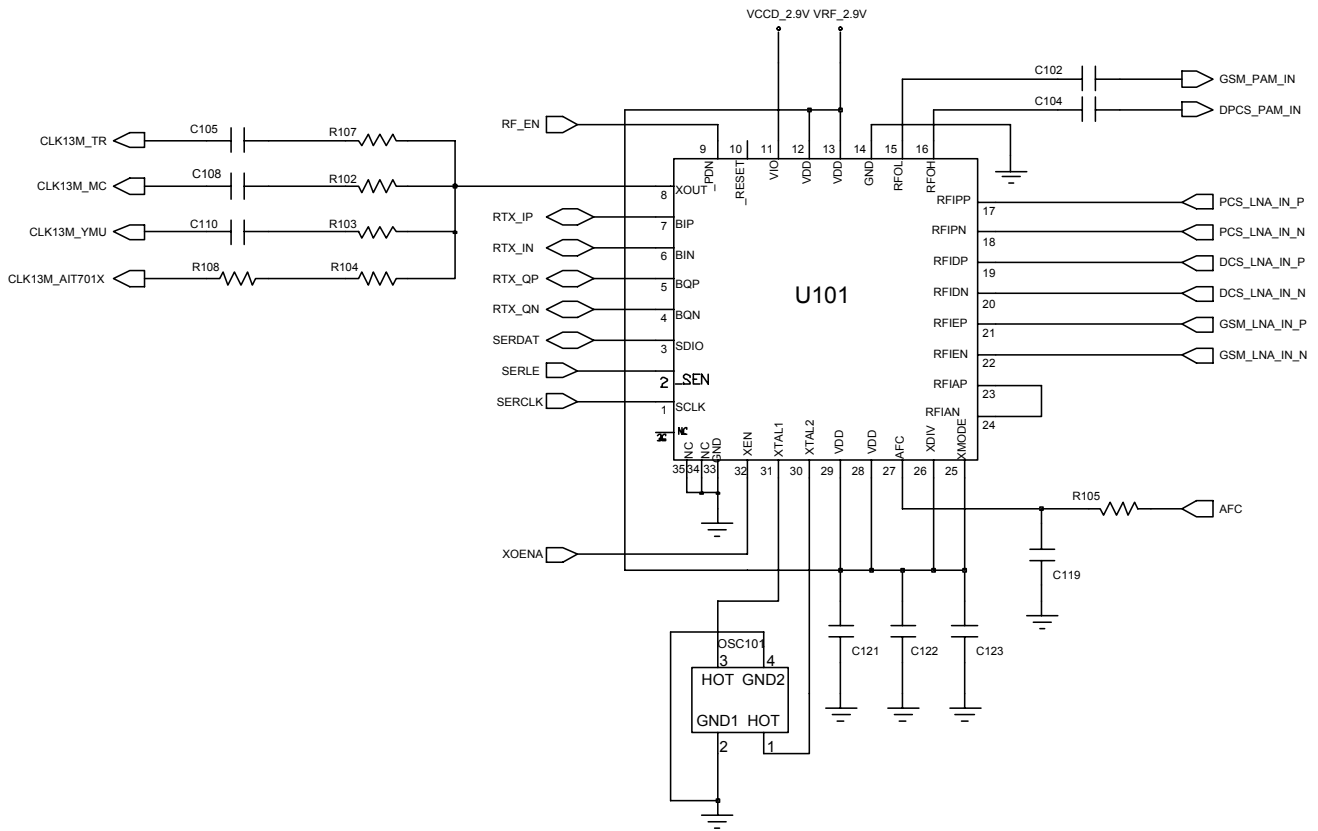

---

## 4. Array course control

---



## Software Downloading

### 4-1. Downloading Binary Files

- Three binary files for downloading M300
  - M300XXYY.s3 : Main source code binary

### 4-2. Pre-requisite for Downloading

- Downloader Program([OptiFlash.exe](#))
- M300 Mobile Phone
- Data Cable
- Binary files



### 4-3. S/W Downloader Program

1. Load the binary download program by executing the "Optiflash.exe"

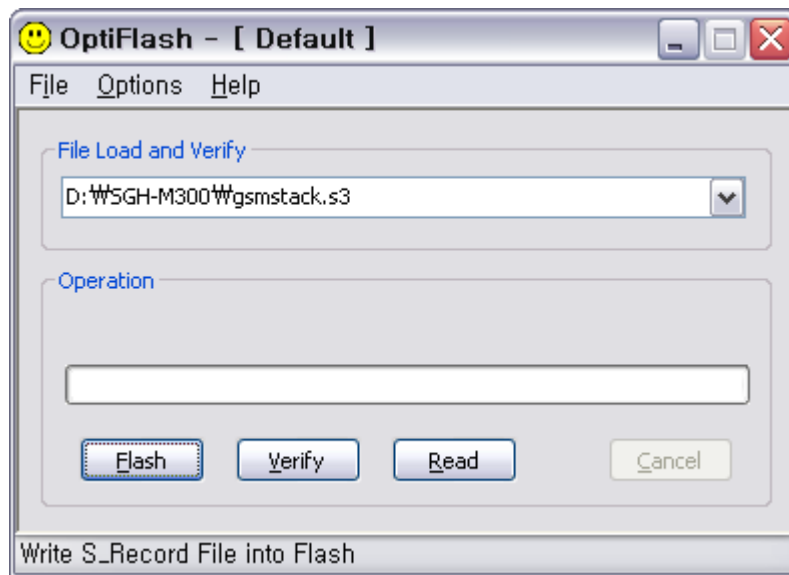

2. Select the "Options" → "Settings" → "Generic" → "Specify hardware platform".

Choose hardware platform for the downloader file setting.

Set the everything else as the default values which are shown below

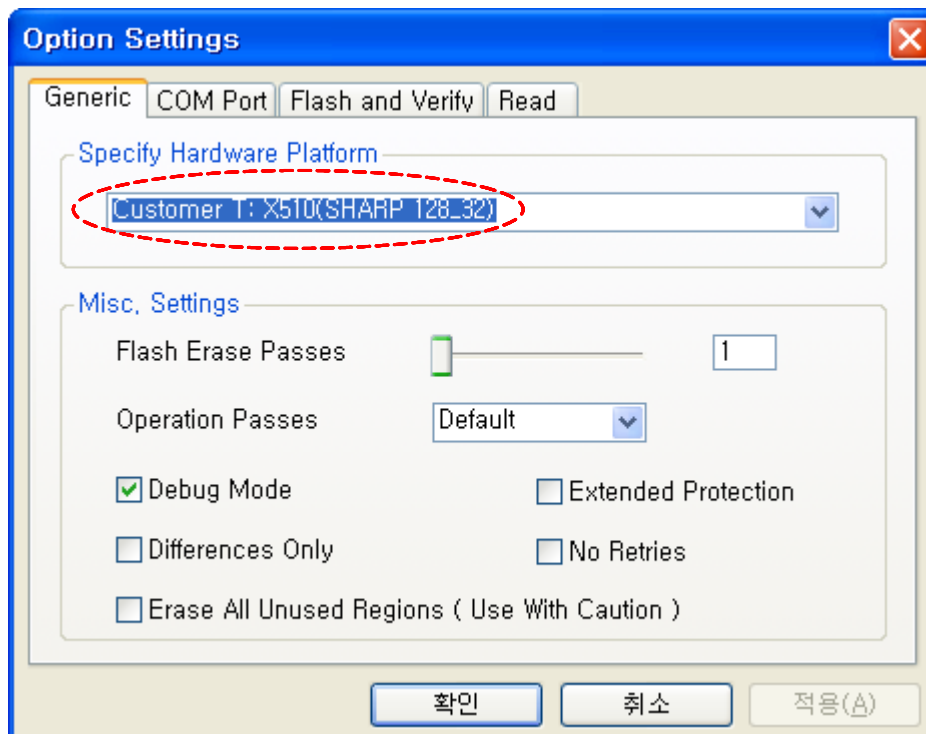

3. Select the **COM port** when the download cable is connected

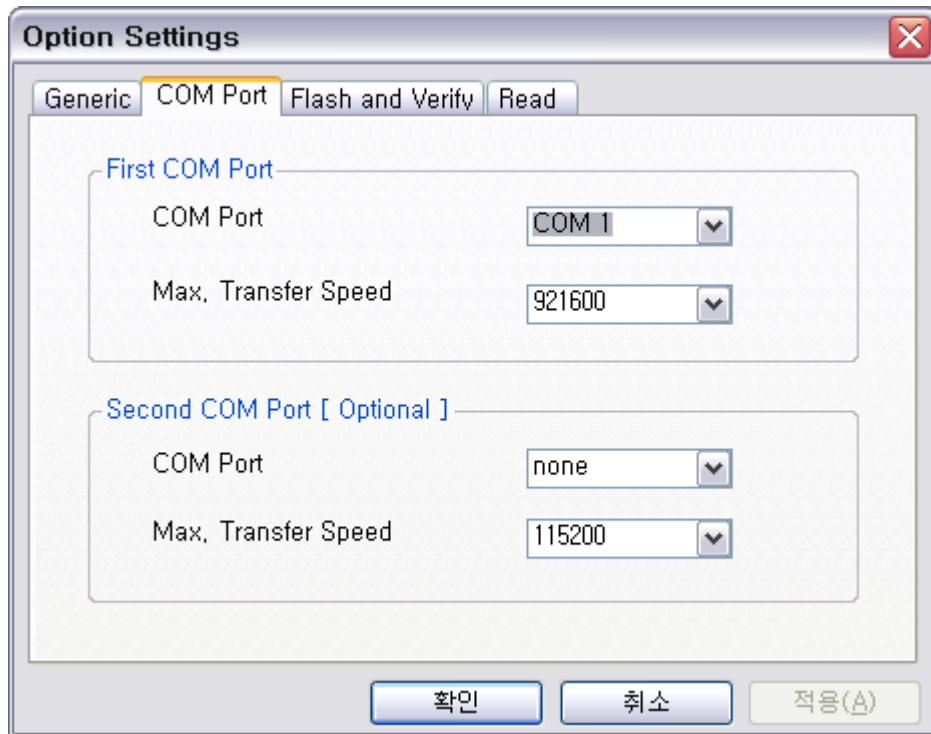

Additionally you can select the maximum transfer speed OptiFlash will use to communicate with the phone. However, OptiFlash will use a slower speed if either the PC's or the phone's serial hardware is incapable of handling the selected speed

4. Select the **"Flash&Verify"** → **"Browse"**

Set the directory path and choose the lastet s/w binary, for example "M300XXYY.s3", for the downloader binary setting.

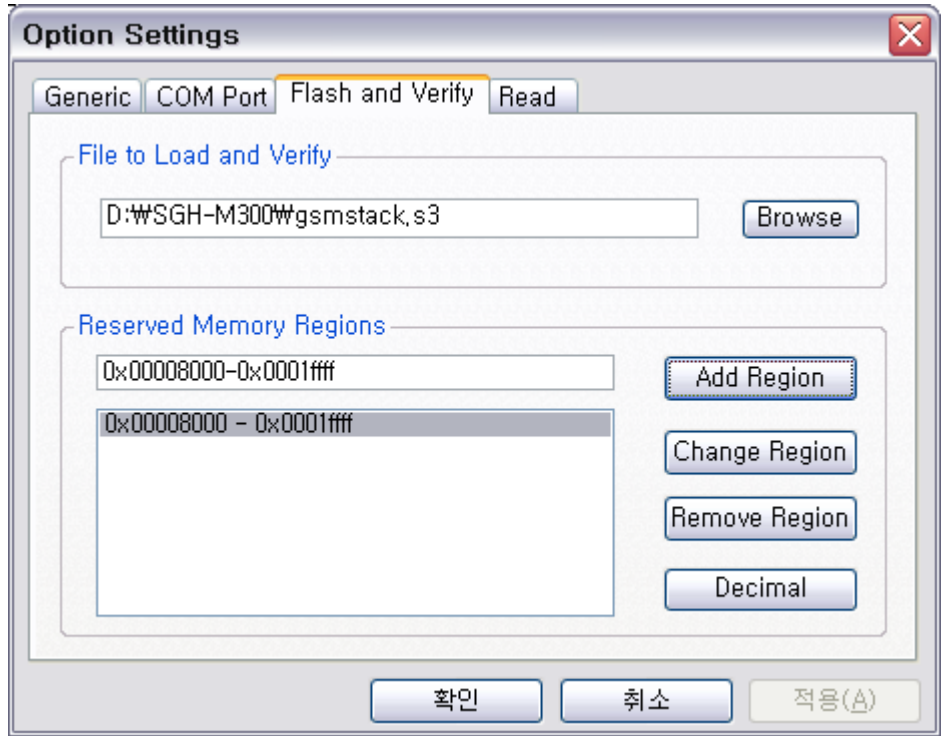

**Make sure that not to change the reserved memory regions.**

**In case of M300 the reserved regions are :**

**- 0x00008000 - 0x0001ffff**

5. Click "OK" button then press "Flash".  
(Before pressing 'Flash' button, push the button '\*\*and 'END' at the same time. Then press 'Flash'.)

Downloader will upload the binary file as below for the downloading.

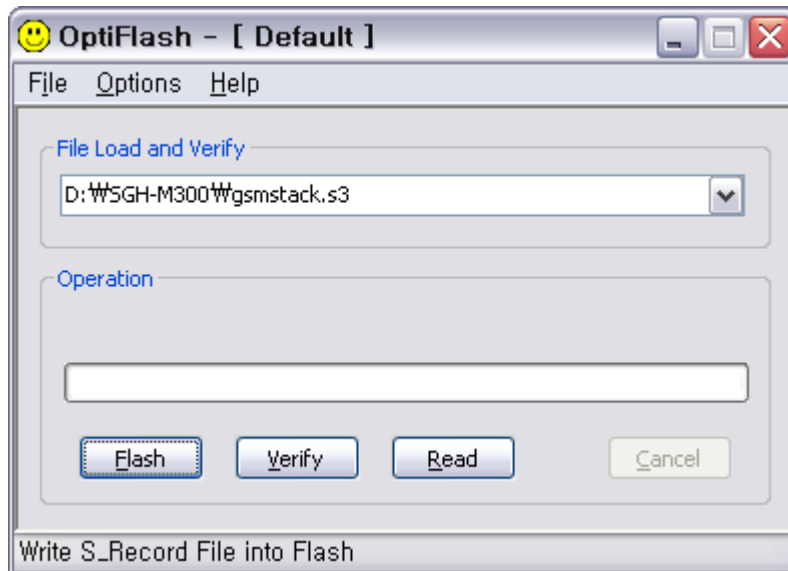

6. When downloading is finished successfully, there is a "All is well" message.
7. After finishing downloading, Certain memory resets should be done to guarantee the normal performance.
8. Confirm the downloaded version name and etc. :  
**\*#1234#**  
Full Reset :  
**\*2767\*3855#**

# 5. Block Diagrams

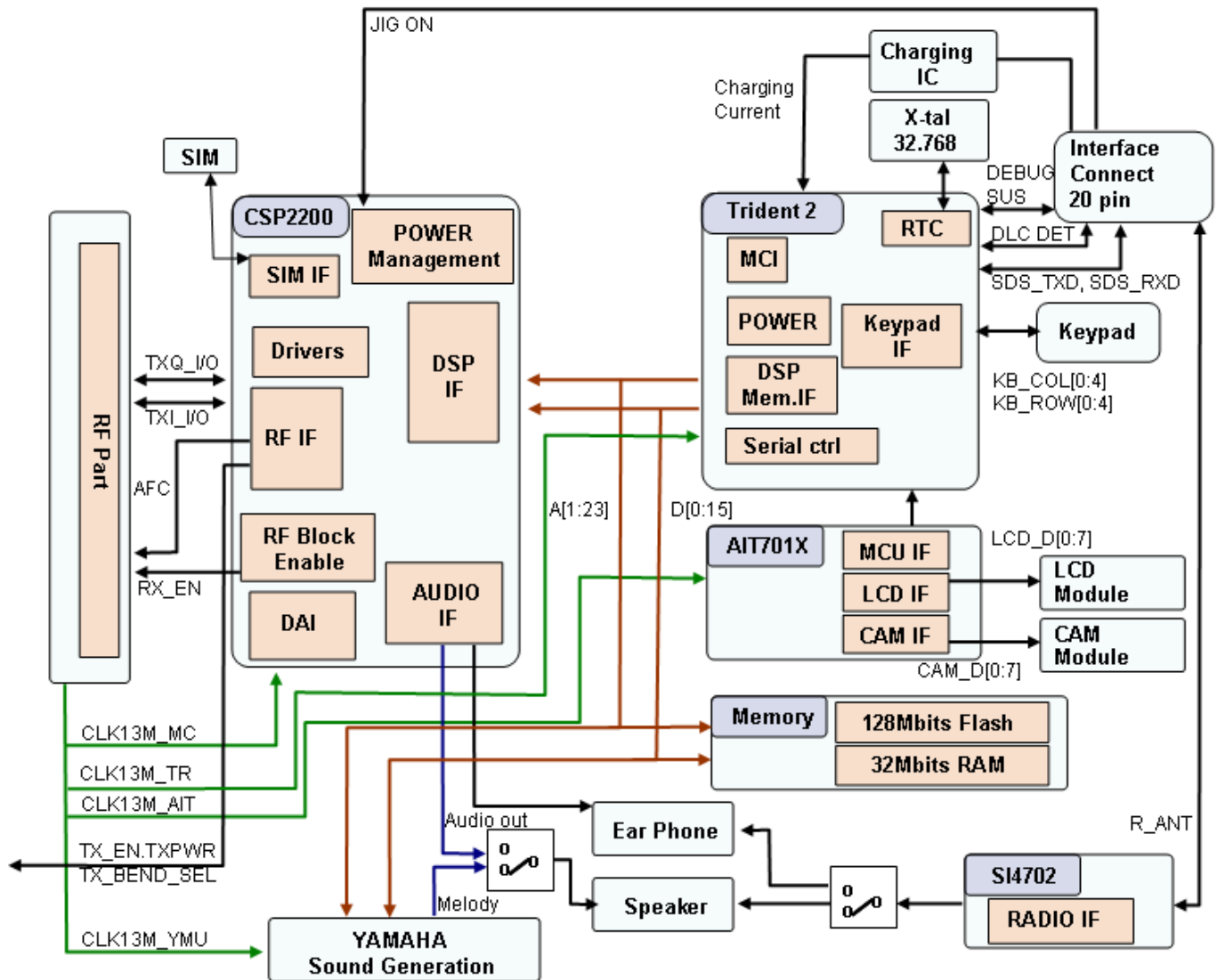

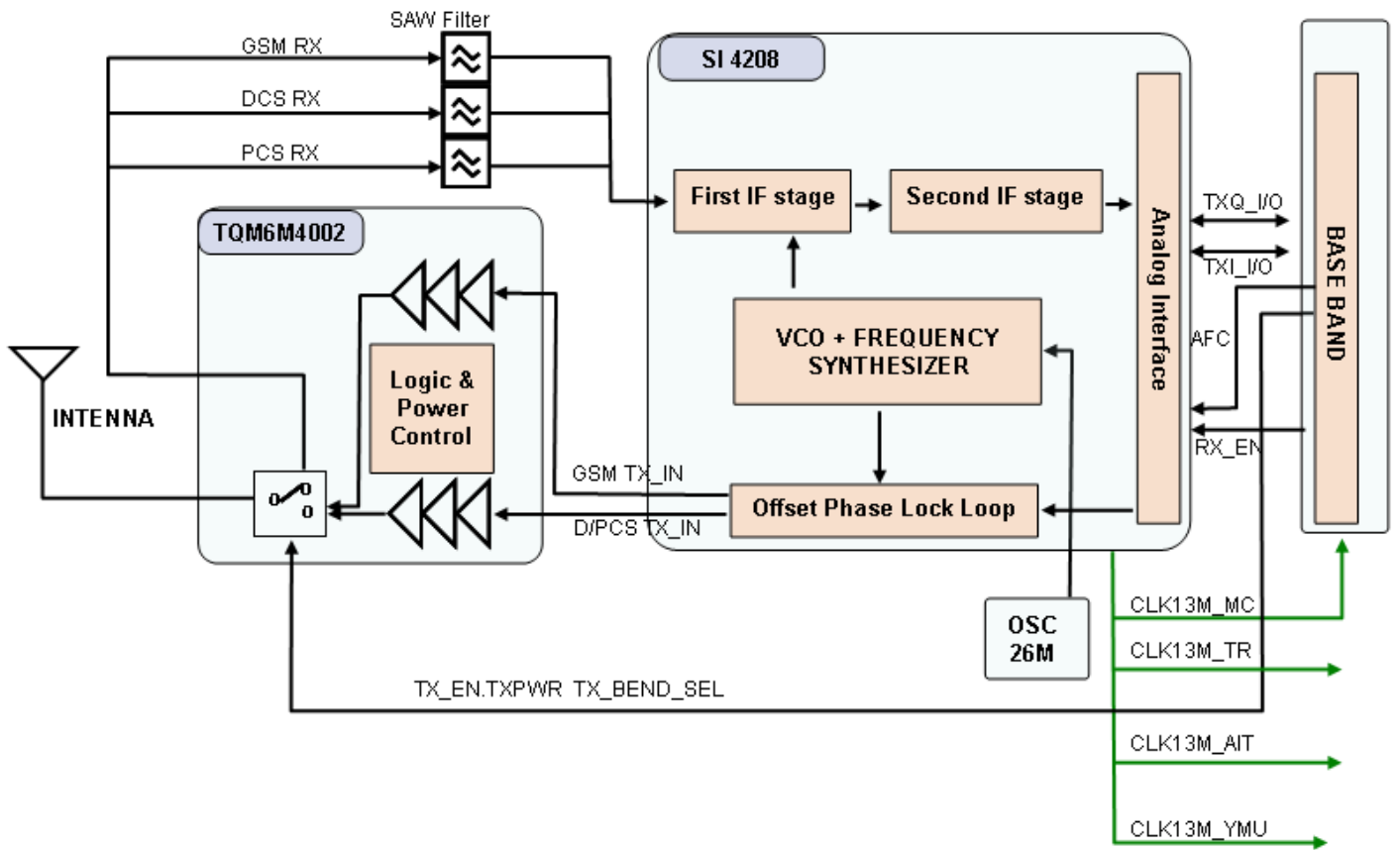

# 6. PCB Diagrams

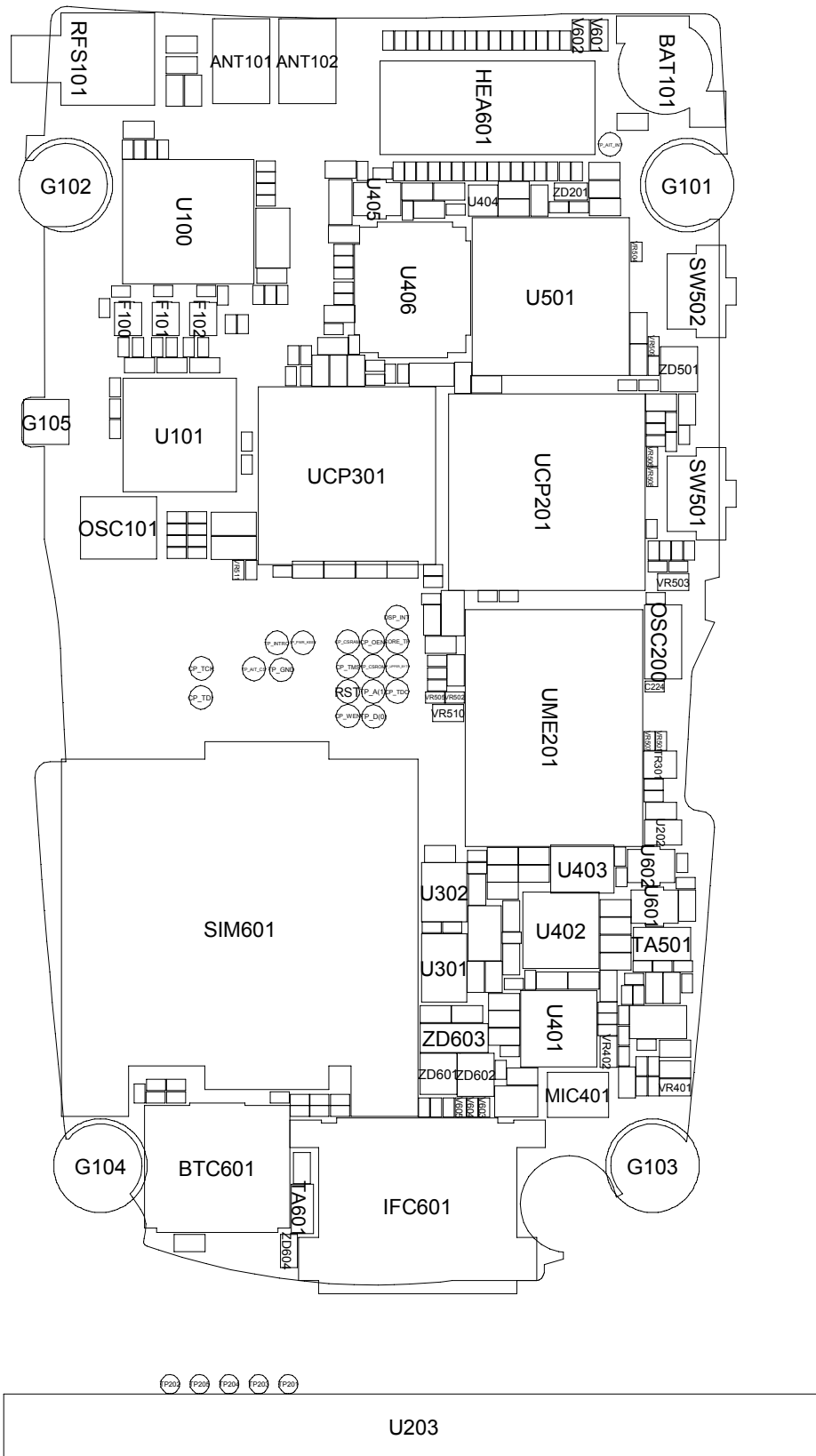

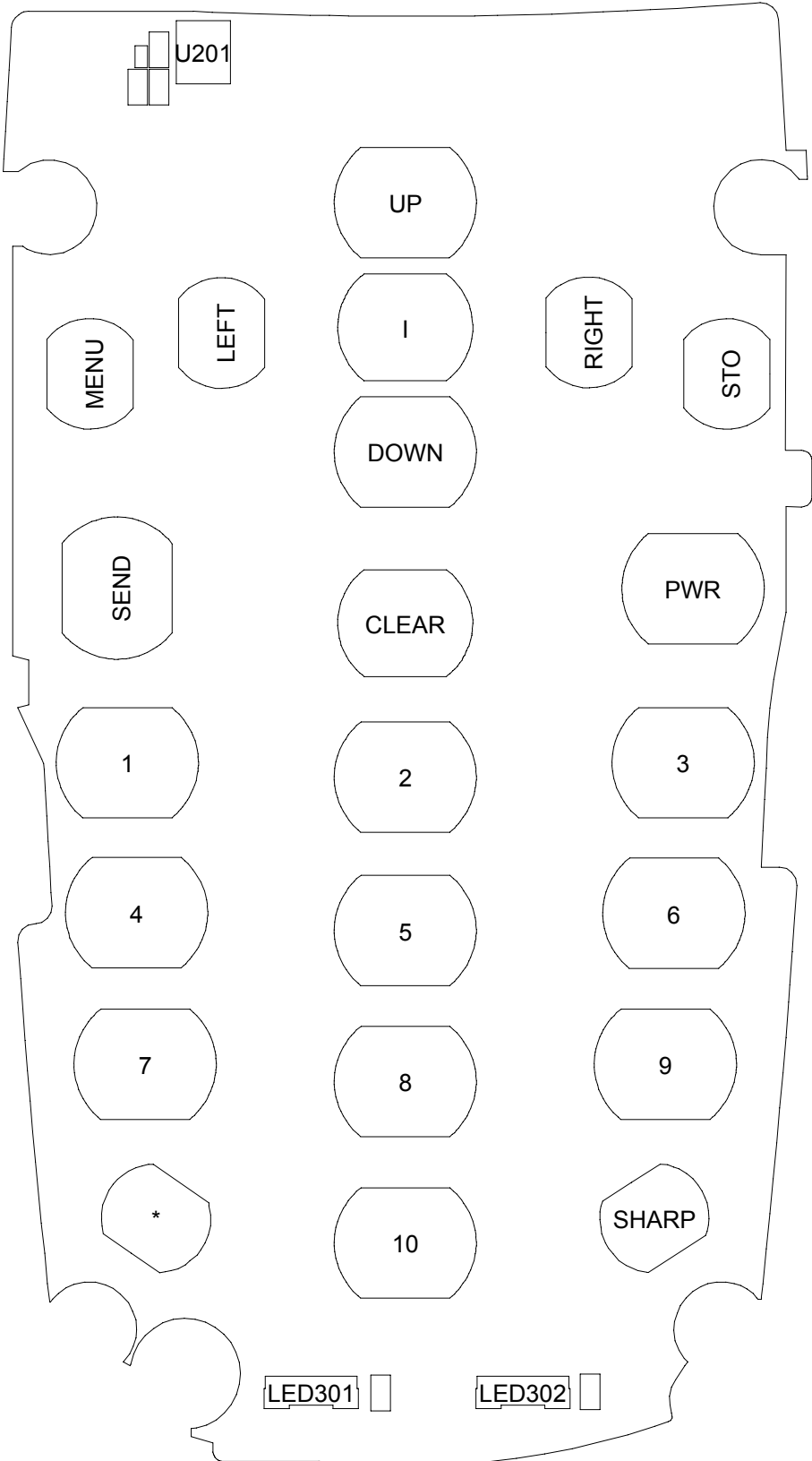



## 7. MAIN Electrical Parts List

SEC CODE	Design LOC	Discirption	STATUS
0403-001547	ZD603	DIODE-ZENER	SA
0406-001190	ZD601	DIODE-TVS	SA
0406-001219	ZD602	DIODE-TVS	SA
0406-001223	ZD604	DIODE-TVS	SA
0406-001231	ZD201	DIODE-TVS	SA
0406-001260	ZD501	DIODE-TVS	SA
0504-001113	TR301	TR-DIGITAL	SA
0601-002268	LED301	LED	SA
0601-002268	LED302	LED	SA
0801-002529	U302	IC-CMOS LOGIC	SA
1001-001394	U404	IC-ANALOG SWITCH	SA
1001-001428	U405	IC-ANALOG MULTIPLEX	SA
1001-001428	U601	IC-ANALOG MULTIPLEX	SA
1001-001428	U602	IC-ANALOG MULTIPLEX	SA
1001-001459	U403	IC-ANALOG SWITCH	SA
1009-001020	U201	IC-HALL EFFECT S/W	SA
1108-000010	UME201	IC-MCP	SA
1201-002180	U402	IC-AUDIO AMP	SA
1201-002278	U100	IC-POWER AMP	SA
1203-003304	UCP301	IC-POWER SUPERVISOR	SA
1203-003663	U301	IC-BATTERY	SA
1204-001811	U406	IC-MELODY	SA
1204-002700	U401	IC-TUNER	SA
1205-003116	U101	IC-TRANSCIEVER	SA
1209-001712	U202	IC-SENSOR	SA
1405-001082	V601	VARISTOR	SA
1405-001082	V602	VARISTOR	SA
1405-001082	VR401	VARISTOR	SA
1405-001082	VR402	VARISTOR	SA
1405-001082	VR503	VARISTOR	SA
1405-001082	VR510	VARISTOR	SA
1405-001177	V603	VARISTOR	SA
1405-001177	V604	VARISTOR	SA
1405-001177	V605	VARISTOR	SA
1405-001177	VR501	VARISTOR	SA
1405-001177	VR502	VARISTOR	SA

SEC CODE	Design LOC	Discirption	STATUS
1405-001177	VR504	VARISTOR	SA
1405-001177	VR505	VARISTOR	SA
1405-001177	VR506	VARISTOR	SA
1405-001177	VR507	VARISTOR	SA
1405-001177	VR508	VARISTOR	SA
1405-001177	VR509	VARISTOR	SA
1405-001177	VR511	VARISTOR	SA
2007-000144	R305	R-CHIP	SA
2007-000148	R406	R-CHIP	SA
2007-000148	R407	R-CHIP	SA
2007-000162	R203	R-CHIP	SA
2007-000162	R206	R-CHIP	SA
2007-000170	R209	R-CHIP	SA
2007-000171	R109	R-CHIP	SA
2007-000171	R110	R-CHIP	SA
2007-000172	R311	R-CHIP	SA
2007-000172	R312	R-CHIP	SA
2007-000173	R417	R-CHIP	SA
2007-000173	R418	R-CHIP	SA
2007-000831	R620	R-CHIP	SA
2007-001244	R309	R-CHIP	SA
2007-007101	R425	R-CHIP	SA
2007-007134	R404	R-CHIP	SA
2007-007134	R405	R-CHIP	SA
2007-007138	R302	R-CHIP	SA
2007-007573	R207	R-CHIP	SA
2007-007573	R208	R-CHIP	SA
2007-007741	R416	R-CHIP	SA
2007-007741	R419	R-CHIP	SA
2007-007741	R507	R-CHIP	SA
2007-007741	R509	R-CHIP	SA
2007-008045	R103	R-CHIP	SA
2007-008048	R102	R-CHIP	SA
2007-008051	R427	R-CHIP	SA
2007-008052	R210	R-CHIP	SA
2007-008052	R211	R-CHIP	SA

SEC CODE	Design LOC	Discirption	STATUS
2007-008055	R301	R-CHIP	SA
2007-008055	R308	R-CHIP	SA
2007-008055	R401	R-CHIP	SA
2007-008419	R613	R-CHIP	SA
2007-008419	R614	R-CHIP	SA
2007-008419	R615	R-CHIP	SA
2007-008419	R616	R-CHIP	SA
2007-008419	R617	R-CHIP	SA
2007-008419	R618	R-CHIP	SA
2007-008419	R619	R-CHIP	SA
2007-008483	R205	R-CHIP	SA
2007-008483	R303	R-CHIP	SA
2007-008483	R403	R-CHIP	SA
2007-008483	R408	R-CHIP	SA
2007-008483	R410	R-CHIP	SA
2007-008483	R412	R-CHIP	SA
2007-008483	R603	R-CHIP	SA
2007-008486	R606	R-CHIP	SA
2007-008486	R607	R-CHIP	SA
2007-008486	R609	R-CHIP	SA
2007-008486	R610	R-CHIP	SA
2007-008516	R105	R-CHIP	SA
2007-008516	R106	R-CHIP	SA
2007-008531	R201	R-CHIP	SA
2007-008531	R202	R-CHIP	SA
2007-008531	R501	R-CHIP	SA
2007-008542	R104	R-CHIP	SA
2007-008542	R108	R-CHIP	SA
2007-008542	R402	R-CHIP	SA
2007-008542	R429	R-CHIP	SA
2007-008544	R411	R-CHIP	SA
2007-008544	R504	R-CHIP	SA
2007-008587	R107	R-CHIP	SA
2007-008786	R424	R-CHIP	SA
2007-008786	R426	R-CHIP	SA
2007-008786	R428	R-CHIP	SA

SEC CODE	Design LOC	Discirption	STATUS
2007-008788	R621	R-CHIP	SA
2007-008788	R622	R-CHIP	SA
2007-008808	R506	R-CHIP	SA
2007-008808	R510	R-CHIP	SA
2007-009108	R423	R-CHIP	SA
2007-009157	R415	R-CHIP	SA
2007-009157	R420	R-CHIP	SA
2007-009160	R304	R-CHIP	SA
2007-009168	R307	R-CHIP	SA
2007-009170	R611	R-CHIP	SA
2007-009171	R602	R-CHIP	SA
2007-009171	R604	R-CHIP	SA
2007-009194	R601	R-CHIP	SNA
2007-009315	R204	R-CHIP	SA
2007-009402	R414	R-CHIP	SA
2007-009402	R505	R-CHIP	SA
2007-009408	R422	R-CHIP	SA
2007-009408	R511	R-CHIP	SA
2203-000233	C222	C-CER,CHIP	SA
2203-000233	C315	C-CER,CHIP	SA
2203-000233	C402	C-CER,CHIP	SA
2203-000359	C420	C-CER,CHIP	SA
2203-000359	C421	C-CER,CHIP	SA
2203-000438	C429	C-CER,CHIP	SA
2203-000654	C427	C-CER,CHIP	SA
2203-000995	C207	C-CER,CHIP	SA
2203-002709	C643	C-CER,CHIP	SA
2203-005682	C104	C-CER,CHIP	SA
2203-005682	C108	C-CER,CHIP	SA
2203-005682	C128	C-CER,CHIP	SA
2203-005682	C130	C-CER,CHIP	SA
2203-005682	C131	C-CER,CHIP	SA
2203-005682	C132	C-CER,CHIP	SA
2203-005682	C423	C-CER,CHIP	SA
2203-005682	C424	C-CER,CHIP	SA
2203-005682	C509	C-CER,CHIP	SA

SEC CODE	Design LOC	Discirption	STATUS
2203-005682	C641	C-CER,CHIP	SA
2203-005682	C642	C-CER,CHIP	SA
2203-005683	C418	C-CER,CHIP	SA
2203-005683	C614	C-CER,CHIP	SA
2203-005683	C631	C-CER,CHIP	SA
2203-005717	C215	C-CER,CHIP	SA
2203-005725	C223	C-CER,CHIP	SA
2203-005725	C224	C-CER,CHIP	SA
2203-005725	C626	C-CER,CHIP	SA
2203-005725	C627	C-CER,CHIP	SA
2203-005729	C105	C-CER,CHIP	SA
2203-005731	C103	C-CER,CHIP	SA
2203-005736	C115	C-CER,CHIP	SA
2203-005736	C118	C-CER,CHIP	SA
2203-005736	C129	C-CER,CHIP	SA
2203-005777	C101	C-CER,CHIP	SA
2203-005777	C106	C-CER,CHIP	SA
2203-005777	C112	C-CER,CHIP	SA
2203-006048	C416	C-CER,CHIP	SA
2203-006048	C428	C-CER,CHIP	SA
2203-006121	C640	C-CER,CHIP	SA
2203-006194	C110	C-CER,CHIP	SA
2203-006194	C119	C-CER,CHIP	SA
2203-006194	C124	C-CER,CHIP	SA
2203-006257	C414	C-CER,CHIP	SA
2203-006257	C506	C-CER,CHIP	SA
2203-006260	C203	C-CER,CHIP	SA
2203-006260	C212	C-CER,CHIP	SA
2203-006307	C307	C-CER,CHIP	SA
2203-006318	C113	C-CER,CHIP	SA
2203-006318	C116	C-CER,CHIP	SA
2203-006318	C117	C-CER,CHIP	SA
2203-006318	C120	C-CER,CHIP	SA
2203-006324	C304	C-CER,CHIP	SA
2203-006423	C121	C-CER,CHIP	SA
2203-006423	C123	C-CER,CHIP	SA

SEC CODE	Design LOC	Discirption	STATUS
2203-006423	C125	C-CER,CHIP	SA
2203-006423	C126	C-CER,CHIP	SA
2203-006423	C206	C-CER,CHIP	SA
2203-006423	C208	C-CER,CHIP	SA
2203-006423	C210	C-CER,CHIP	SA
2203-006423	C214	C-CER,CHIP	SA
2203-006423	C217	C-CER,CHIP	SA
2203-006423	C218	C-CER,CHIP	SA
2203-006423	C219	C-CER,CHIP	SA
2203-006423	C220	C-CER,CHIP	SA
2203-006423	C221	C-CER,CHIP	SA
2203-006423	C301	C-CER,CHIP	SA
2203-006423	C319	C-CER,CHIP	SA
2203-006423	C408	C-CER,CHIP	SA
2203-006423	C431	C-CER,CHIP	SA
2203-006423	C502	C-CER,CHIP	SA
2203-006423	C503	C-CER,CHIP	SA
2203-006423	C615	C-CER,CHIP	SA
2203-006423	C630	C-CER,CHIP	SA
2203-006423	C639	C-CER,CHIP	SA
2203-006462	C425	C-CER,CHIP	SA
2203-006556	C102	C-CER,CHIP	SA
2203-006556	C111	C-CER,CHIP	SA
2203-006556	C601	C-CER,CHIP	SA
2203-006556	C602	C-CER,CHIP	SA
2203-006556	C603	C-CER,CHIP	SA
2203-006556	C604	C-CER,CHIP	SA
2203-006556	C605	C-CER,CHIP	SA
2203-006556	C606	C-CER,CHIP	SA
2203-006556	C607	C-CER,CHIP	SA
2203-006556	C608	C-CER,CHIP	SA
2203-006556	C609	C-CER,CHIP	SA
2203-006556	C610	C-CER,CHIP	SA
2203-006556	C611	C-CER,CHIP	SA
2203-006556	C612	C-CER,CHIP	SA
2203-006556	C613	C-CER,CHIP	SA

SEC CODE	Design LOC	Discirption	STATUS
2203-006556	C617	C-CER,CHIP	SA
2203-006556	C618	C-CER,CHIP	SA
2203-006556	C619	C-CER,CHIP	SA
2203-006556	C620	C-CER,CHIP	SA
2203-006556	C621	C-CER,CHIP	SA
2203-006556	C622	C-CER,CHIP	SA
2203-006556	C623	C-CER,CHIP	SA
2203-006556	C624	C-CER,CHIP	SA
2203-006556	C625	C-CER,CHIP	SA
2203-006556	C628	C-CER,CHIP	SA
2203-006556	C629	C-CER,CHIP	SA
2203-006556	C638	C-CER,CHIP	SA
2203-006562	C306	C-CER,CHIP	SA
2203-006562	C308	C-CER,CHIP	SA
2203-006562	C309	C-CER,CHIP	SA
2203-006562	C310	C-CER,CHIP	SA
2203-006562	C311	C-CER,CHIP	SA
2203-006562	C313	C-CER,CHIP	SA
2203-006562	C316	C-CER,CHIP	SA
2203-006562	C318	C-CER,CHIP	SA
2203-006562	C401	C-CER,CHIP	SA
2203-006562	C403	C-CER,CHIP	SA
2203-006562	C404	C-CER,CHIP	SA
2203-006562	C405	C-CER,CHIP	SA
2203-006562	C406	C-CER,CHIP	SA
2203-006562	C407	C-CER,CHIP	SA
2203-006562	C410	C-CER,CHIP	SA
2203-006562	C411	C-CER,CHIP	SA
2203-006562	C412	C-CER,CHIP	SA
2203-006562	C422	C-CER,CHIP	SA
2203-006562	C434	C-CER,CHIP	SA
2203-006562	C501	C-CER,CHIP	SA
2203-006562	C504	C-CER,CHIP	SA
2203-006562	C616	C-CER,CHIP	SA
2203-006562	C635	C-CER,CHIP	SA
2203-006562	C644	C-CER,CHIP	SA

SEC CODE	Design LOC	Discirption	STATUS
2203-006626	C507	C-CER,CHIP	SA
2203-006626	C508	C-CER,CHIP	SA
2203-006648	C122	C-CER,CHIP	SA
2203-006648	C216	C-CER,CHIP	SA
2203-006648	C317	C-CER,CHIP	SA
2203-006648	C409	C-CER,CHIP	SA
2203-006648	C426	C-CER,CHIP	SA
2203-006648	C636	C-CER,CHIP	SA
2203-006824	C312	C-CER,CHIP	SA
2203-006824	C314	C-CER,CHIP	SA
2203-006824	C417	C-CER,CHIP	SA
2203-006824	C430	C-CER,CHIP	SA
2203-006872	C432	C-CER,CHIP	SA
2203-006872	C433	C-CER,CHIP	SA
2203-006979	C201	C-CER,CHIP	SA
2203-006979	C202	C-CER,CHIP	SA
2203-006979	C204	C-CER,CHIP	SA
2203-006979	C205	C-CER,CHIP	SA
2203-006979	C209	C-CER,CHIP	SA
2203-006979	C211	C-CER,CHIP	SA
2203-006979	C213	C-CER,CHIP	SA
2203-006979	C302	C-CER,CHIP	SA
2203-006979	C303	C-CER,CHIP	SA
2203-007143	C415	C-CER,CHIP	SA
2203-007143	C419	C-CER,CHIP	SA
2404-001374	C127	C-TA,CHIP	SA
2404-001381	TA601	C-TA,CHIP	SA
2404-001414	C413	C-TA,CHIP	SA
2404-001414	TA501	C-TA,CHIP	SA
2703-002313	L105	INDUCTOR-SMD	SA
2703-002485	L102	INDUCTOR-SMD	SA
2703-002544	L108	INDUCTOR-SMD	SA
2703-002544	L109	INDUCTOR-SMD	SA
2703-002558	L110	INDUCTOR-SMD	SA
2703-002917	L103	INDUCTOR-SMD	SA
2703-002917	L104	INDUCTOR-SMD	SA



SEC CODE	Design LOC	Discirption	STATUS
2703-003196	L603	INDUCTOR-SMD	SA
2801-004373	OSC200	CRYSTAL-SMD	SA
2801-004587	OSC101	CRYSTAL-SMD	SA
2904-001592	F100	FILTER-SAW	SA
2904-001599	F101	FILTER-SAW	SA
2904-001600	F102	FILTER-SAW	SA
3301-001342	L201	BEAD-SMD	SA
3301-001659	L403	BEAD-SMD	SA
3301-001729	L401	BEAD-SMD	SA
3301-001729	L402	BEAD-SMD	SA
3301-001729	L601	BEAD-SMD	SA
3301-001729	L602	BEAD-SMD	SA
3404-001303	SW501	SWITCH-TACT	SA
3404-001303	SW502	SWITCH-TACT	SA
3705-001242	RFS101	CONNECTOR-COAXIAL	SA
3709-001488	SIM601	CONNECTOR-CARD EDGE	SA
3710-002442	IFC601	SOCKET-INTERFACE	SA
3711-006026	BTC601	HEADER-BATTERY	SA
3711-006380	HEA601	HEADER-BOARD TO BOARD	SA
4302-001130	BAT101	BATTERY-LI(2ND)	SA
GH09-00036A	UCP201	IC MICOM-SGHX480	SA
GH13-00050A	U501	IC ASIC-SGHC510	SA
GH71-06419A	ANT101	NPR-ANTENNA CONTACT	SA
GH71-06419A	ANT102	NPR-ANTENNA CONTACT	SA

---

## 8. Reference data

---

### 8-1. Reference Abbreviate

**AAC:** Advanced Audio Coding.

**AVC :** Advanced Video Coding.

**BER :** Bit Error Rate

**BPSK:** Binary Phase Shift Keying

**CA :** Conditional Access

**CDM :** Code Division Multiplexing

**C/I :** Carrier to Interference

**DMB :** Digital Multimedia Broadcasting

**EN :** European Standard

**ES :** Elementary Stream

**ETSI:** European Telecommunications Standards Institute

**MPEG:** Moving Picture Experts Group

**PN :** Pseudo-random Noise

**PS :** Pilot Symbol

**QPSK:** Quadrature Phase Shift Keying

**RS :** Reed-Solomon

**SI :** Service Information

**TDM :** Time Division Multiplexing

**TS :** Transport Stream

---

## 9. Safety Precautions

---

### 9-1. Repair Precaution

- Repair in Shield Box, during detailed tuning.  
Take specially care of tuning or test,  
because specipcty of cellular phone is sensitive for surrounding interference(RF noise).
- Be careful to use a kind of magnetic object or tool,  
because performance of parts is damaged by the influence of manetic force.
- Surely use a standard screwdriver when you disassemble this product,  
otherwise screw will be worn away.
- Use a thicken twisted wire when you measure level.  
A thicken twisted wire has low resistance, therefore error of measurement is few.
- Repair after separate Test Pack and Set because for short danger (for example an  
overcurrent and furious flames of parts etc) when you repair board in condition of  
connecting Test Pack and tuning on.
- Take specially care of soldering, because Land of PCB is small and weak in heat.
- Surely tune on/off while using AC power plug, because a repair of battery charger is  
dangerous when tuning ON/OFF PBA and Connector after disassembling charger.
- Don't use as you pleases after change other material than replacement registered on SEC  
System. Otherwise engineer in charge isn't charged with problem that you don't keep this  
rules.

## 9-2. ESD(Electrostatically Sensitive Devices) Precaution

Several semiconductor may be damaged easily by static electricity. Such parts are called by ESD(Electrostatically Sensitive Devices), for example IC,BGA chip etc. Read Precaution below. You can prevent from ESD damage by static electricity.

- Remove static electricity remained your body before you touch semiconductor or parts with semiconductor. There are ways that you touch an earthed place or wear static electricity prevention string on wrist.
- Use earthed soldering steel when you connect or disconnect ESD.
- Use soldering removing tool to break static electricity. , otherwise ESD will be damaged by static electricity.
- Don't unpack until you set up ESD on product. Because most of ESD are packed by box and aluminum plate to have conductive power,they are prevented from static electricity.
- You must maintain electric contact between ESD and place due to be set up until ESD is connected completely to the proper place or a circuit board.

---

## 10. Product Function

---

### Main Function

- SDN (Service Dialling Numbers)
- Read SMS or MMS messages
- Voicemail
- SOS message
- FM radio

**SAMSUNG  
ELECTRONICS**



GSPN (Global Service Partner Network)

<b>Country</b>	<b>Web Site</b>
North America	<a href="http://service.samsungportal.com">service.samsungportal.com</a>
Latin America	<a href="http://latin.samsungportal.com">latin.samsungportal.com</a>
CIS	<a href="http://cis.samsungportal.com">cis.samsungportal.com</a>
Europe	<a href="http://europe.samsungportal.com">europe.samsungportal.com</a>
China	<a href="http://china.samsungportal.com">china.samsungportal.com</a>
Asia	<a href="http://asia.samsungportal.com">asia.samsungportal.com</a>
Mideast & Africa	<a href="http://mea.samsungportal.com">mea.samsungportal.com</a>