

SAMSUNG

GSM TELEPHONE

SGH-i710

SERVICE *Manual*

GSM TELEPHONE



CONTENTS

1. Safety Precautions
2. Specification
3. Operation Instruction and Installation
4. Array course control
5. Exploded View/Disassembly and Assembly Instructions
6. MAIN Electrical Parts List
7. Block Diagrams
8. PCB Diagrams
9. Flow Chart of Troubleshooting
10. Reference data

**SAMSUNG
ELECTRONICS**



GSPN (Global Service Partner Network)

Country	Web Site
North America	service.samsungportal.com
Latin America	latin.samsungportal.com
CIS	cis.samsungportal.com
Europe	europe.samsungportal.com
China	china.samsungportal.com
Asia	asia.samsungportal.com
Mideast & Africa	mea.samsungportal.com

1. Safety Precautions

1-1. Repair Precaution

- Repair in Shield Box, during detailed tuning. Take specially care of tuning or test, because specipicty of cellular phone is sensitive for surrounding interference(RF noise).
- Be careful to use a kind of magnetic object or tool, because performance of parts is damaged by the influence of magnetic force.
- Surely use a standard screwdriver when you disassemble this product, otherwise screw will be worn away.
- Use a thicken twisted wire when you measure level. A thicken twisted wire has low resistance, therefore error of measurement is few.
- Repair after separate Test Pack and Set because for short danger (for example an overcurrent and furious flames of parts etc) when you repair board in condition of connecting Test Pack and tuning on.
- Take specially care of soldering, because Land of PCB is small and weak in heat.
- Surely tune on/off while using AC power plug, because a repair of battery charger is dangerous when tuning ON/OFF PBA and Connector after disassembling charger.
- Don't use as you pleases after change other material than replacement registered on SEC System. Otherwise engineer in charge isn't charged with problem that you don't keep this rules.

1-2. ESD(Electrostatically Sensitive Devices) Precaution

Several semiconductor may be damaged easily by static electricity. Such parts are called by ESD (Electrostatically Sensitive Devices), for example IC,BGA chip etc. Read Precaution below.

You can prevent from ESD damage by static electricity.

- Remove static electricity remained your body before you touch semiconductor or parts with semiconductor. There are ways that you touch an earthed place or wear static electricity prevention string on wrist.
- Use earthed soldering steel when you connect or disconnect ESD.
- Use soldering removing tool to break static electricity. , otherwise ESD will be damaged by static electricity.
- Don't unpack until you set up ESD on product. Because most of ESD are packed by box and aluminum plate to have conductive power,they are prevented from static electricity.
- You must maintain electric contact between ESD and place due to be set up until ESD is connected completely to the proper place or a circuit board.

2. Specification

2-1. GSM General Specification

	GSM850 Phase 1	EGSM 900 Phase 2	DCS1800 Phase 1	PCS1900
Freq. Band[MHz] Uplink/Downlink	824~849 869~894	880~915 925~960	1710~1785 1805~1880	1850~1910 1930~1990
ARFCN range	128~251	0~124 & 975~1023	512~885	512~810
Tx/Rx spacing	45MHz	45MHz	95MHz	80MHz
Mod. Bit rate/ Bit Period	270.833kbps 3.692us	270.833kbps 3.692us	270.833kbps 3.692us	270.833kbps 3.692us
Time Slot Period/Frame Period	576.9us 4.615ms	576.9us 4.615ms	576.9us 4.615ms	576.9us 4.615ms
Modulation	0.3GMSK	0.3GMSK	0.3GMSK	0.3GMSK
MS Power	33dBm~5dBm	33dBm~5dBm	30dBm~0dBm	30dBm~0dBm
Power Class	5pcl ~ 19pcl	5pcl ~ 19pcl	0pcl ~ 15pcl	0pcl ~ 15pcl
Sensitivity	-102dBm	-102dBm	-100dBm	-100dBm
TDMA Mux	8	8	8	8
Cell Radius	35Km	35Km	2Km	2Km

2-2. GSM Tx Power Class

TX Power control level	GSM850	TX Power control level	EGSM900	TX Power control level	DCS1800	TX Power control level	PCS1900
5	33±2 dBm	5	33±2 dBm	0	30±3 dBm	0	30±3 dBm
6	31±2 dBm	6	31±2 dBm	1	28±3 dBm	1	28±3 dBm
7	29±2 dBm	7	29±2 dBm	2	26±3 dBm	2	26±3 dBm
8	27±2 dBm	8	27±2 dBm	3	24±3 dBm	3	24±3 dBm
9	25±2 dBm	9	25±2 dBm	4	22±3 dBm	4	22±3 dBm
10	23±2 dBm	10	23±2 dBm	5	20±3 dBm	5	20±3 dBm
11	21±2 dBm	11	21±2 dBm	6	18±3 dBm	6	18±3 dBm
12	19±2 dBm	12	19±2 dBm	7	16±3 dBm	7	16±3 dBm
13	17±2 dBm	13	17±2 dBm	8	14±3 dBm	8	14±3 dBm
14	15±2 dBm	14	15±2 dBm	9	12±4 dBm	9	12±4 dBm
15	13±2 dBm	15	13±2 dBm	10	10±4 dBm	10	10±4 dBm
16	11±3 dBm	16	11±3 dBm	11	8±4 dBm	11	8±4 dBm
17	9±3dBm	17	9±3dBm	12	6±4 dBm	12	6±4 dBm
18	7±3 dBm	18	7±3 dBm	13	4±4 dBm	13	4±4 dBm
19	5±3 dBm	19	5±3 dBm	14	2±5 dBm	14	2±5 dBm
				15	0±5 dBm	15	0±5 dBm

3. Operation Instruction and Installation

Main Function

- Slim Bar Design 2.5G MITS
- 2 Megapixel Camera with AutoFocus
- 2.8" QVGA 262K Color TFT Screen
- External Memory microSD (T-Flash)
- Video Recording & Messaging
- Music Player(MP3/AAC/AAC+)
- Bluetooth Wireless Technology V 2.0 + EDR
- Multimedia Message Service (MMS)/SMS/E-mail
- Voice recorder
- Speaker Phone
- Java MIDP 2.0/ WAP2.0
- GSM/GPRS Class 10
- Quad-band(850/900/1800/1900MHz)

4. Array course control

4-1. Software Adjustments

Test Jig

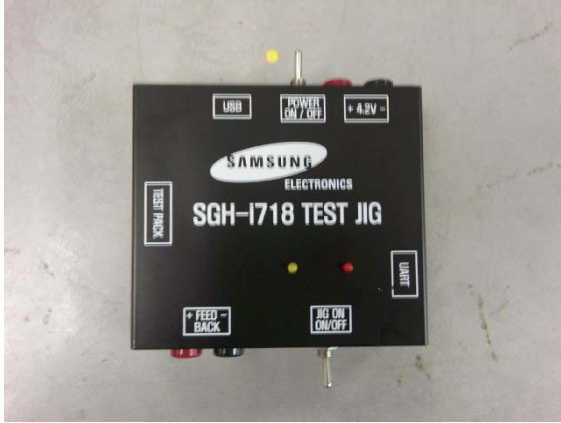

Jig cable (GH39-00777A)



Serial Cable(CSA LL64151-A)



Power Cable



USB DATA CABLE (CSA LL11105 AWM)



4-2. Software Downloading

4-2-1. Pre-requests for Downloading

- Downloader Program([Becks_Downloader_v01.exe](#))
- SGH-i710 Mobile Phone
- USB Data Cable
- UART Data Cable(Serial Cabel)
- Binary files (PDA & Phone binary)

4-2-2. S/W Downloader Program

4-2-2-1. Phone S/W Downloading

- Load the binary download program by executing the “[Becks_Downloader_v01.exe](#)”

1. Select the connected serial port and the rate of speed
2. Select the file what you want to download

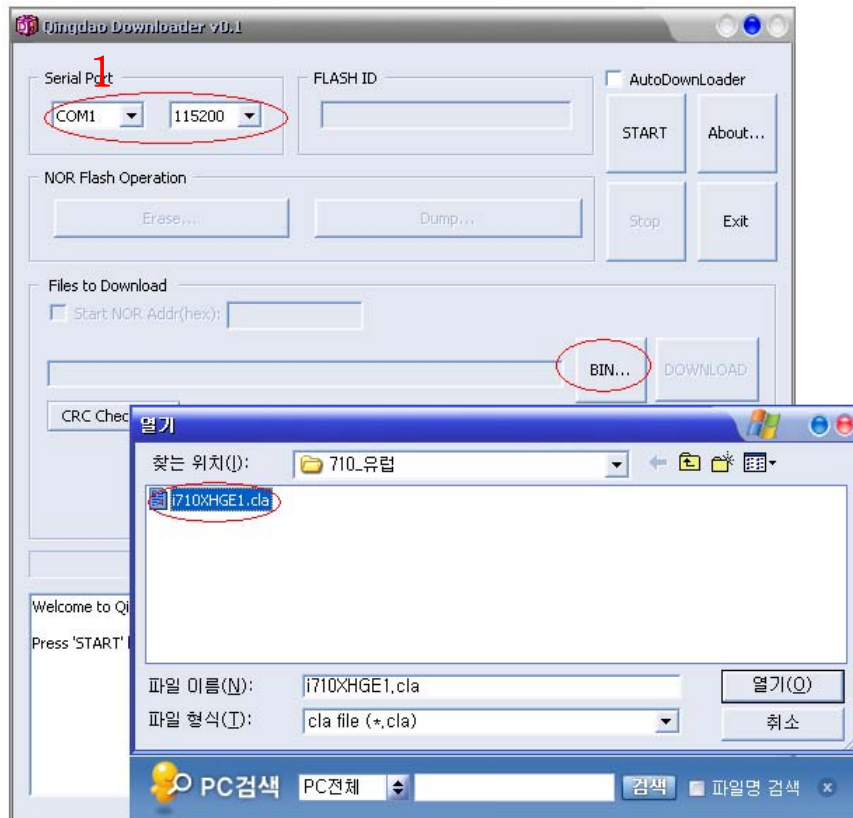

3. Then, click the start button.

4-2-2-2. PDA S/W Downloading

- Load the binary download program by executing the "i710XHGE1_FRANCE_PDA.exe" (It's up to binary version)

1. Click the Detect button.

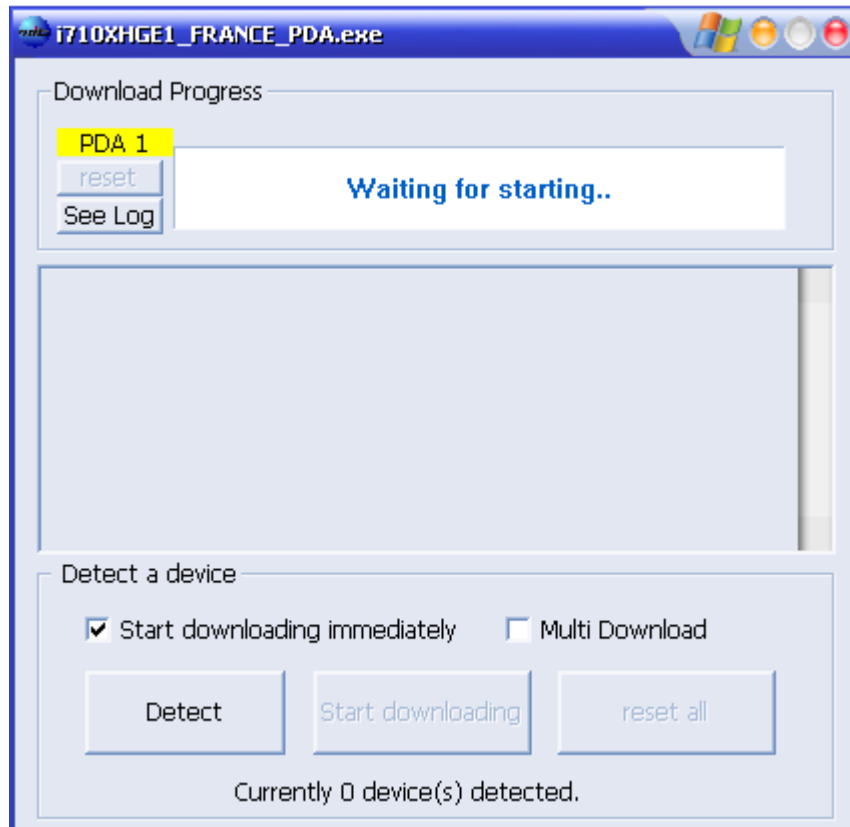

5. Exploded View/Disassembly&Assembly Instructions

5-1. Cellular phone Exploded View

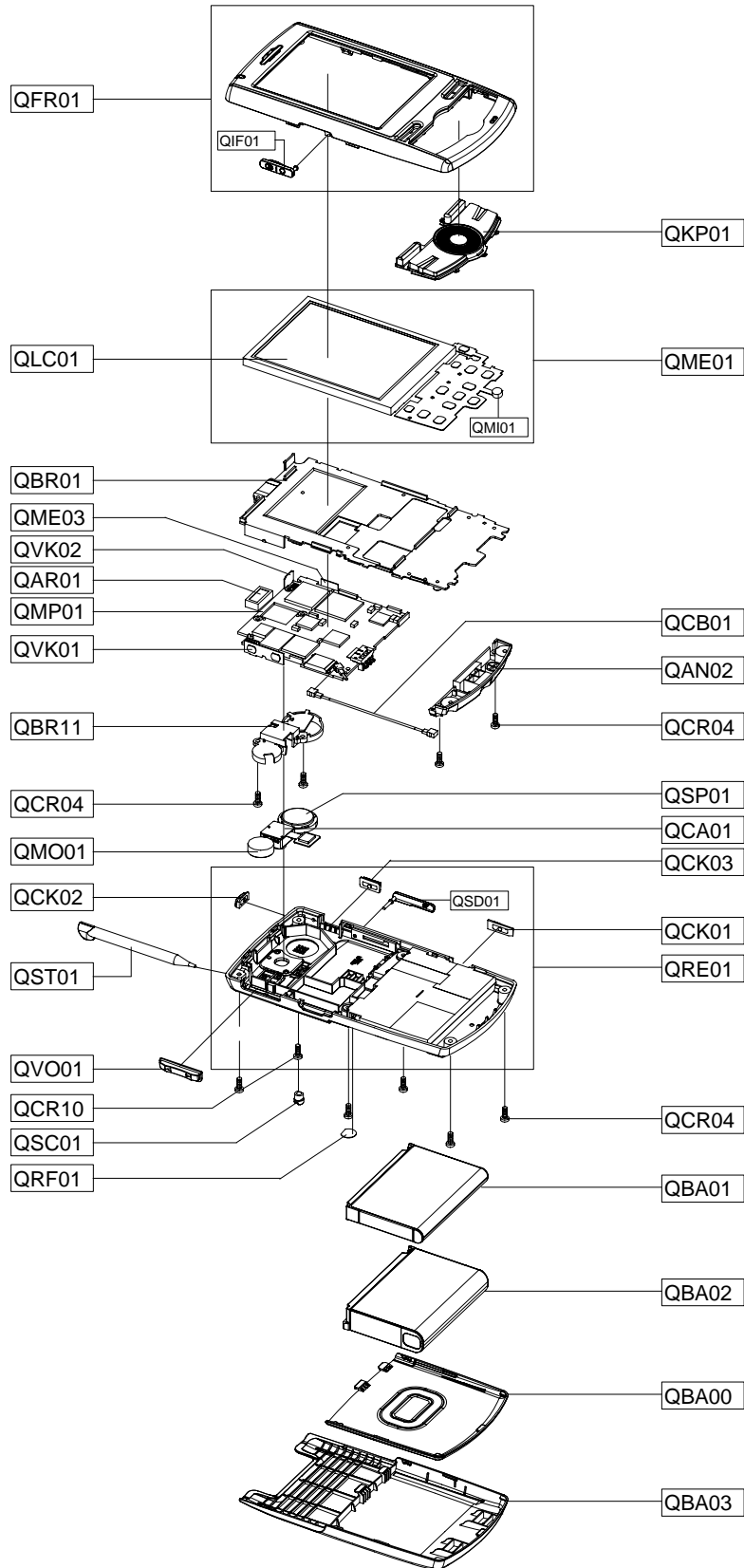



5-2. Cellular phone Parts list



Design LOC	Description	SEC CODE
QAN02	ANTENNA-SGHI718	GH42-01078A
QAR01	AUDIO-RECEIVER	3009-001250
QBA00	PMO-COVER BATTERY	GH72-35831A
QBA01	INNER BATTERY PACK-1300MAH,BLK	GH43-02827A
QBA02	INNER BATTERY PACK-1800MAH,BLK	GH43-02781A
QBA03	PMO-COVER EXT BATT	GH72-38333A
QBR01	ASSY BRACKET-BRACKET SHIELD	GH98-03033A
QBR11	ASSY BRACKET-CAMERA HOUSING	GH98-03032A
QCA01	UNIT-CAMERA	GH59-03771A
QCB01	CBF COAXIAL CABLE-SGHI718 COAX	GH39-00755A
QCK01	PMO-CAMERA KEY	GH72-35838A
QCK02	PMO-POWER KEY	GH72-35832A
QCK03	PMO-REC KEY	GH72-35837A
QCR04	SCREW-MACHINE	6001-001479
QCR10	SCREW-MACHINE	6001-001633
QFR01	ASSY CASE-FRONT	GH98-04392A
QIF01	PMO-COVER IF V2	GH72-37119A
QKP01	ASSY KEYPAD-(CUH/BLK)	GH98-03036A
QLC01	LCD-MODULE SGHI718	GH07-01016A
QME01	KEY FPCB-KEY FPCB ASSY	GH59-03798A
QME03	KEY FPCB-RECORD KEY ASSY	GH59-03786A
QMO01	MOTOR DC-SGHI718	GH31-00289A
QMP01	PBA-SGH-I710	GH92-03706A
QRE01	ASSY CASE-REAR	GH98-03035A
QRF01	MPR-TAPE RF HOLE	GH74-29317A
QSC01	PMO-COVER SCREW	GH72-35840A
QSD01	PMO-COVER M SD	GH72-35835A
QSP01	SPEAKER	3001-002091
QST01	ASSY ACCE-STYLUS PEN(SILVER)	GH98-03060A
QVK01	KEY FPCB-VOLUME KEY ASSY	GH59-03801A
QVK02	KEY FPCB-POWER KEY ASSY	GH59-03803A
QVO01	ASSY KEY-VOLUME KEY	GH98-03809A

Description	SEC CODE
CBF INTERFACE-DATA LINK CABLE	GH39-00444A
ADAPTOR-SGHE690,BLK,EU,A_TYPE	GH44-01361A
CHARGER-SGHI601,BTC,BLK	GH44-01664A
EARPHONE-B-TYPE	GH59-03883A
MPR-SPONGE MIC	GH74-29899A
MPR-INSU TAPE	GH74-30639A
MPR-INSU TAPE	GH74-29721A
MPR-INSU TAPE	GH74-29722A
MPR-INSU TAPE SPK	GH74-29723A
MPR-TAPE RESET SWITCH	GH74-30295A
MPR-TAPE MAIN FPCB A	GH74-17751A
MPR-VINYL BOHO LCD TSTC	GH74-31131A
BAG PE	6902-000634
LABEL(P)-UNIT SEAL	GH68-00518B
LABEL(R)-MAIN(XEF)	GH68-14706C
BOX-UNIT(EU)	GH69-05353B
CUSHION-CASE(EU)	GH69-05357A
LABEL(P)-OPEN MP3	GH68-11246A
S/W CD-SGHI710(FRAN) COMPANIO	GH46-00456A
MANUAL USERS-XEFFRENCH QRG	GH68-15012A

5-3. Disassembly and Assembly Instructions

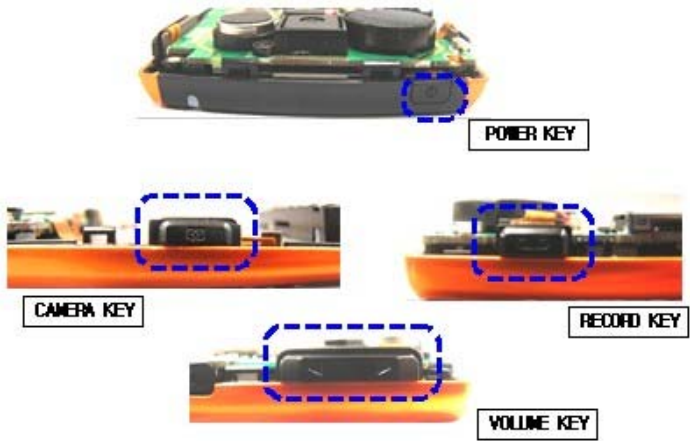
– Disassembly

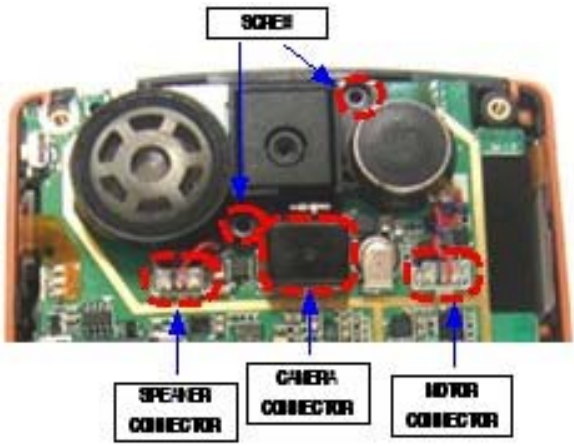
<p>1</p> 	<p>2</p> 
<p>1) Remove the SCREW COVER on the left side by using tweezers and separate the STYLUS PEN on the right side.</p>	<p>1) Unscrew the 6 points.</p>
<p>3</p> 	<p>4</p> 
<p>1) Separate the REAR COVER from the bottom to the top on the VOLUME KEY side. 2) Separate the REAR COVER from the bottom to the top on the CAMERA KEY side. - Be careful of the damage of HOOKs on the COVER.</p>	<p>1) Separate the REAR COVER without damage of HOOKs on the top side. 2) Remove the KEYS(CAMERA, RECORD, POWER, VOLUME).</p>

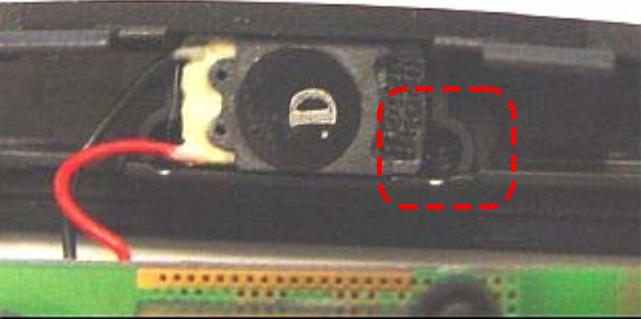
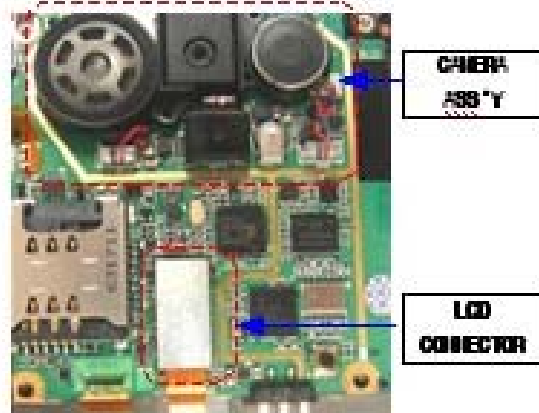
<p>5</p>  <p>The image shows the internal components of the phone's PBA. Two screws are marked with blue arrows and labeled 'SCREW'. Three connectors are circled in red and labeled: 'SPEAKER CONNECTOR', 'CAMERA CONNECTOR', and 'MOTOR CONNECTOR'.</p>	<p>6</p>  <p>The image shows the phone's front cover with the 'CAMERA KEY FPCB' and 'KEY FPCB CONNECTOR' highlighted with red dashed lines.</p>
<p>1) Unscrew the 2 marked points on the picture and disconnect the CAMERA, MOTOR, SPEAKER CONNECTOR from PBA.</p>	<p>1) Separate the CAMERA KEY FPCB from the FRONT COVER by using tweezers. 2) Remove the TAPE on the KEY FPCB CONNECTOR by using tweezers. 3) Push the Hooks to out side on the FRONT COVER and Separate the FRAME from it.</p>
<p>7</p>  <p>The image shows a close-up of the receiver speaker assembly. A red dashed circle highlights the point where the speaker is attached to the front cover.</p>	<p>8</p>  <p>The image shows the internal PBA with the 'CAMERA ASS'Y' and 'LCD CONNECTOR' highlighted with blue arrows.</p>
<p>1) Hold up the PBA ASS'Y, and Separate the RECEIVER SPEAKER from the FRONT COVER by putting the tweezers into the marked point on the picture. - Be careful of damage of the COVER and SPEAKER WIRE.</p>	<p>1) Separate the CAMERA ASS'Y and the LCD CONNECTOR from the PBA.</p>

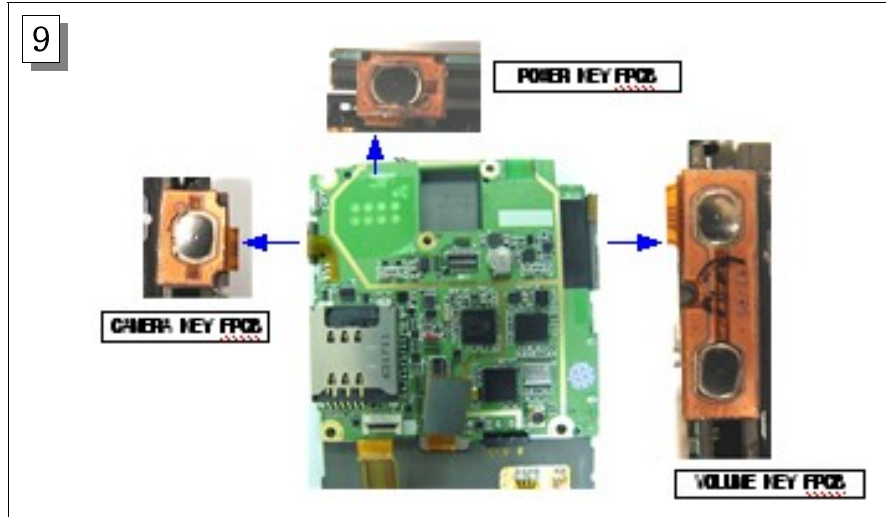

1) Separate KEY FPCBs(POWER, VOLUME, RECORD) from the FRAME by using tweezers.
 - Be careful of damage of FPCBs

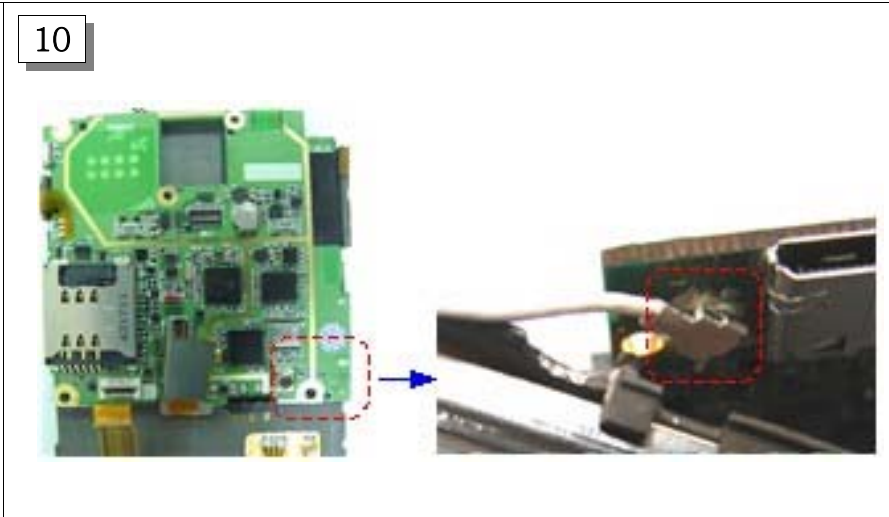

1) Hold up the PBA slowly and disconnect the ANTENNA CABLE on the back side of the PBA.

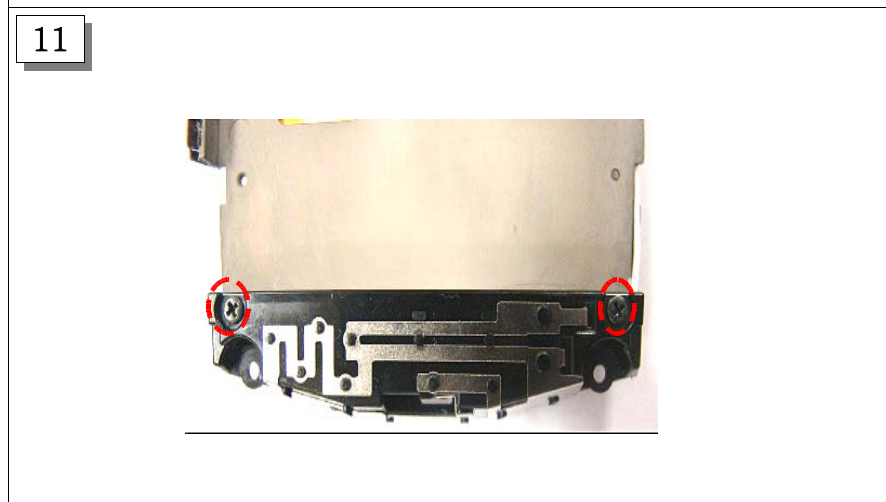

1) Unscrew the 2 marked points and separate the ANTENNA.



1) Detach the ANTENNA CABLE from the ANTENNA.

13



- 1) Detach the FPCB from the FRAME by using tweezers
- Be careful of damage of the FPCB.

14



- 1) Hold up the LCD from the bottom and detach the LCD from the LCD FRAME.
- Be careful of damage of the LCD and the FRAME

— Assembly

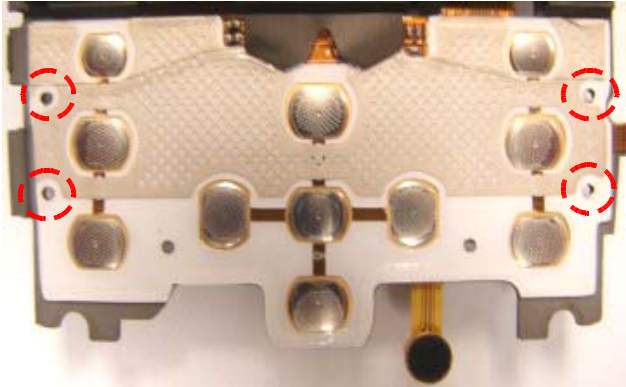
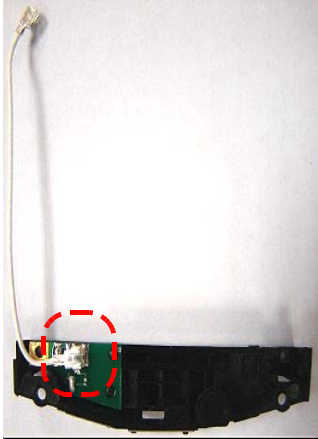
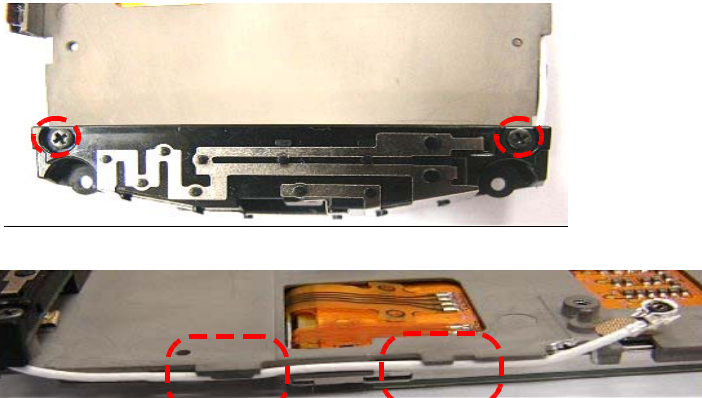
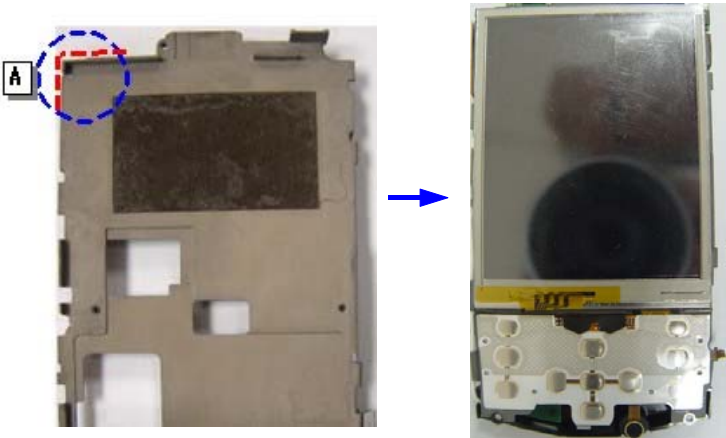
<p>1</p> 	<p>2</p> 
<p>1) Attach the KEY FPCB on the FRAME along by red marked hole on the picture. - Be careful of damage of FPCB.</p>	<p>1) Attach the INTENNA CABLE to the connection point on the INTENNA</p>
<p>3</p> 	<p>4</p> 
<p>1) Screw the 2 points to the INTENNA to fix the FRAME. 2) Hold the INTENNA CABLE in the FRAME.</p>	<p>1) Remove the release paper(both-sided TAPE) from the FRAME and attach the LCD to the FRAME along by the guide line on the left-top side of the frame.</p>

5

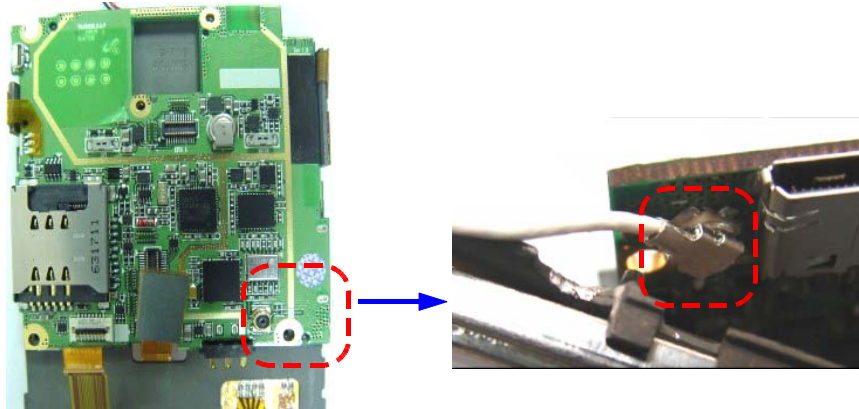

- 1) Attach the PBA to the FRAME after connect the INTENNA CABLE to the cable connector on the back side of the PBA

6

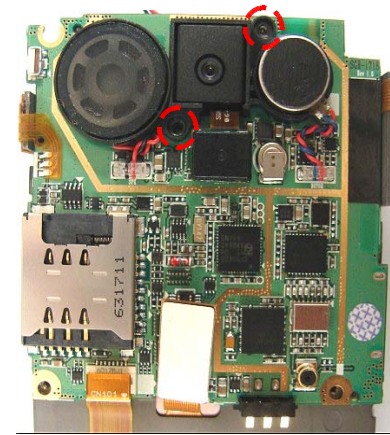

- 1) Attach the CAMERA ASS'Y to the PBA and connect CAMERA, MOTOR, SPKAKER CONNECTOR to the PBA.
- 2) Screw the 2 points on the CAMERA ASS'Y to fix it.

7

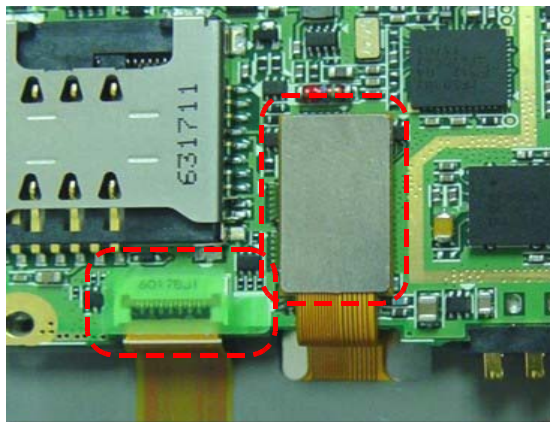

- 1) Connect the KEY FPCB to the connector on the PBA and attach the TAPE on it along the PCB SILK guide line by using the tweezers(pincette).
- 2) Connect the LCD CONNECTOR to the PBA.

8

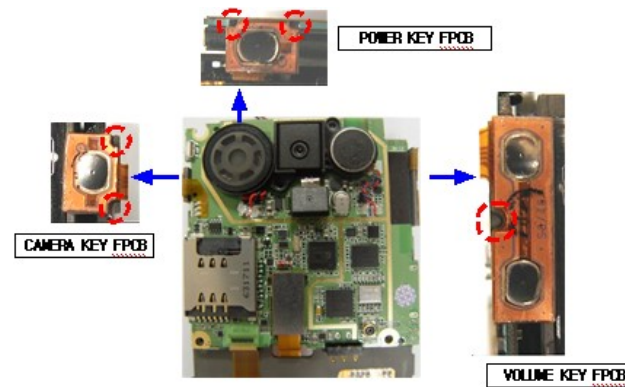

- 1) Attach the KEY FPCB(POWER, VOLUME, RECORD) to the FRAME according to guide rules on the picture.

9

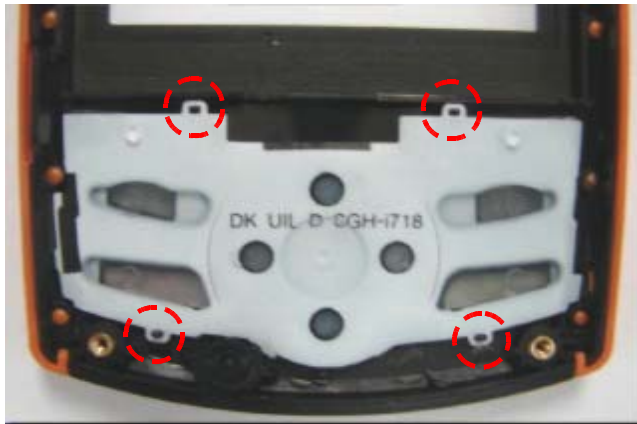

1) Attach the KEYPAD to the FRONT COVER along by the fixed poles.

10

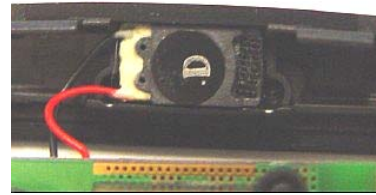

CAMERA KEY
FPCB 부착부

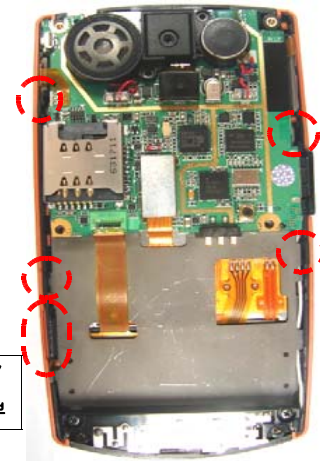

1) Remove the release paper on the RECEIVER and attach Receiver to the FRONT COVER.
2) Attach the FRAME ASS'Y to the FRONT COVER by using the HOOKS and attach the CAMERA KEY FPCB to the FRONT COVER.

11

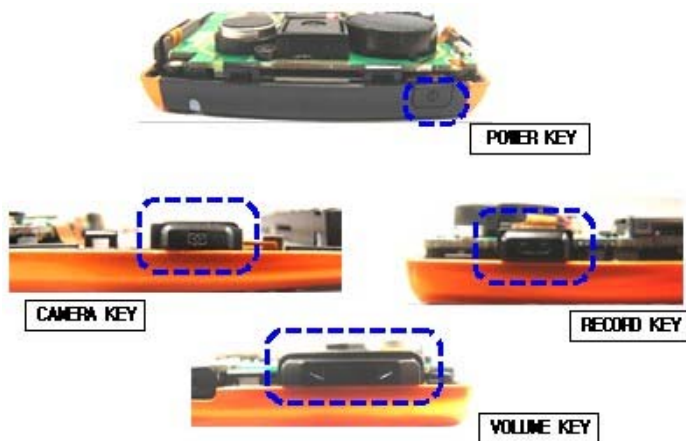



1) Attach the KEYS(CAMERA, RECORD, POWER, VOLUME) to the FRONT COVER.

12



1) Assemble the REAR COVER being careful of the hooks

<p>13</p> 	<p>14</p> 
<p>1) Screw the 6 points.</p>	<p>1) Attach the SCREW COVER on the left side and insert the STYLUS PEN on the right side.</p>

6. MAIN Electrical Parts List

Design LOC	Description	SEC Code	STATUS
ANT600	ANTENNA-CHIP	4202-001263	SA
BAT900	BATTERY-LI(2ND)	4302-001181	SA
BTC300	HEADER-BATTERY	3711-006078	SA
C105	C-CER,CHIP	2203-006562	SA
C107	C-CER,CHIP	2203-006423	SA
C111	C-CER,CHIP	2203-006423	SA
C113	C-CER,CHIP	2203-006423	SA
C117	C-CER,CHIP	2203-006423	SA
C118	C-CER,CHIP	2203-006423	SA
C119	C-CER,CHIP	2203-006423	SA
C124	C-CER,CHIP	2203-006423	SA
C125	C-CER,CHIP	2203-006562	SA
C126	C-CER,CHIP	2203-006562	SA
C127	C-CER,CHIP	2203-006423	SA
C128	C-CER,CHIP	2203-006423	SA
C130	C-CER,CHIP	2203-006423	SA
C131	C-CER,CHIP	2203-006423	SA
C133	C-CER,CHIP	2203-006423	SA
C134	C-CER,CHIP	2203-006423	SA
C135	C-CER,CHIP	2203-006423	SA
C137	C-CER,CHIP	2203-006562	SA
C138	C-CER,CHIP	2203-006562	SA
C139	C-CER,CHIP	2203-006423	SA
C140	C-CER,CHIP	2203-006562	SA
C141	C-CER,CHIP	2203-006562	SA
C142	C-CER,CHIP	2203-006562	SA
C143	C-CER,CHIP	2203-006423	SA
C144	C-CER,CHIP	2203-006048	SA
C145	C-CER,CHIP	2203-006048	SA
C146	C-CER,CHIP	2203-006048	SA
C151	C-CER,CHIP	2203-006423	SA
C152	C-CER,CHIP	2203-006562	SA
C200	C-CER,CHIP	2203-006423	SA
C201	C-CER,CHIP	2203-006423	SA
C202	C-CER,CHIP	2203-006562	SA
C203	C-CER,CHIP	2203-006562	SA
C204	C-CER,CHIP	2203-006423	SA
C206	C-CER,CHIP	2203-006423	SA
C210	C-CER,CHIP	2203-006423	SA
C211	C-CER,CHIP	2203-006423	SA
C212	C-CER,CHIP	2203-006423	SA
C215	C-CER,CHIP	2203-006423	SA
C216	C-CER,CHIP	2203-006423	SA
C217	C-CER,CHIP	2203-006423	SA
C218	C-CER,CHIP	2203-006423	SA
C219	C-CER,CHIP	2203-006562	SA
C220	C-CER,CHIP	2203-006562	SA
C221	C-CER,CHIP	2203-006423	SA
C223	C-CER,CHIP	2203-006423	SA
C224	C-CER,CHIP	2203-006562	SA

Design LOC	Description	SEC Code	STATUS
C225	C-CER,CHIP	2203-006562	SA
C301	C-CER,CHIP	2203-000654	SA
C302	C-CER,CHIP	2203-006562	SA
C304	C-CER,CHIP	2203-006824	SA
C306	C-CER,CHIP	2203-006562	SA
C307	C-CER,CHIP	2203-006562	SA
C308	C-CER,CHIP	2203-006562	SA
C309	C-CER,CHIP	2203-006824	SA
C310	C-CER,CHIP	2203-006824	SA
C311	C-CER,CHIP	2203-006824	SA
C312	C-CER,CHIP	2203-002443	SA
C313	C-CER,CHIP	2203-006474	SA
C314	C-CER,CHIP	2203-002443	SA
C318	C-CER,CHIP	2203-006824	SA
C320	C-CER,CHIP	2203-006890	SA
C321	C-CER,CHIP	2203-006890	SA
C322	C-CER,CHIP	2203-006824	SA
C323	C-CER,CHIP	2203-006474	SA
C324	C-CER,CHIP	2203-006361	SA
C325	C-CER,CHIP	2203-000138	SA
C326	C-CER,CHIP	2203-006048	SA
C327	C-CER,CHIP	2203-000254	SA
C328	C-CER,CHIP	2203-006562	SA
C329	C-CER,CHIP	2203-006824	SA
C330	C-CER,CHIP	2203-006824	SA
C331	C-CER,CHIP	2203-006423	SA
C332	C-CER,CHIP	2203-006474	SA
C333	C-CER,CHIP	2203-006562	SA
C336	C-CER,CHIP	2203-006423	SA
C337	C-CER,CHIP	2203-006824	SA
C338	C-CER,CHIP	2203-006890	SA
C339	C-CER,CHIP	2203-006824	SA
C340	C-CER,CHIP	2203-006562	SA
C342	C-CER,CHIP	2203-006562	SA
C360	C-CER,CHIP	2203-006824	SA
C362	C-CER,CHIP	2203-006890	SA
C363	C-CER,CHIP	2203-006361	SA
C364	C-CER,CHIP	2203-006562	SA
C366	C-CER,CHIP	2203-006562	SA
C367	C-CER,CHIP	2203-006562	SA
C369	C-CER,CHIP	2203-006048	SA
C370	C-CER,CHIP	2203-006423	SA
C371	C-CER,CHIP	2203-006423	SA
C372	C-CER,CHIP	2203-006423	SA
C374	C-CER,CHIP	2203-006890	SA
C375	C-CER,CHIP	2203-006361	SA
C402	C-CER,CHIP	2203-006423	SA
C405	C-CER,CHIP	2203-006423	SA
C407	C-CER,CHIP	2203-006824	SA
C408	C-CER,CHIP	2203-006048	SA

Design LOC	Description	SEC Code	STATUS
C412	C-CER,CHIP	2203-006562	SA
C413	C-CER,CHIP	2203-006562	SA
C414	C-CER,CHIP	2203-006562	SA
C415	C-CER,CHIP	2203-000725	SA
C418	C-CER,CHIP	2203-006562	SA
C419	C-CER,CHIP	2203-000725	SA
C422	C-CER,CHIP	2203-005481	SA
C423	C-CER,CHIP	2203-006562	SA
C424	C-CER,CHIP	2203-006824	SA
C425	C-CER,CHIP	2203-006824	SA
C427	C-CER,CHIP	2203-006626	SA
C429	C-CER,CHIP	2203-000812	SA
C430	C-CER,CHIP	2203-000679	SA
C431	C-CER,CHIP	2203-000812	SA
C432	C-CER,CHIP	2203-006423	SA
C436	C-CER,CHIP	2203-006562	SA
C437	C-CER,CHIP	2203-006048	SA
C438	C-CER,CHIP	2203-006048	SA
C451	C-CER,CHIP	2203-000278	SA
C452	C-CER,CHIP	2203-000278	SA
C454	C-CER,CHIP	2203-000278	SA
C460	C-CER,CHIP	2203-000254	SA
C461	C-CER,CHIP	2203-006305	SA
C464	C-CER,CHIP	2203-006305	SA
C466	C-CER,CHIP	2203-006423	SA
C467	C-CER,CHIP	2203-000254	SA
C469	C-CER,CHIP	2203-000254	SA
C500	C-CER,CHIP	2203-006562	SA
C501	C-CER,CHIP	2203-006562	SA
C510	C-CER,CHIP	2203-000278	SA
C511	C-CER,CHIP	2203-000812	SA
C512	C-CER,CHIP	2203-000679	SA
C513	C-CER,CHIP	2203-005050	SA
C514	C-CER,CHIP	2203-000278	SA
C515	C-CER,CHIP	2203-000812	SA
C520	C-CER,CHIP	2203-000812	SA
C523	C-CER,CHIP	2203-000812	SA
C530	C-CER,CHIP	2203-006562	SA
C533	C-CER,CHIP	2203-006423	SA
C534	C-CER,CHIP	2203-000812	SA
C600	C-CER,CHIP	2203-006324	SA
C605	C-CER,CHIP	2203-006048	SA
C606	C-CER,CHIP	2203-006562	SA
C607	C-CER,CHIP	2203-006978	SA
C608	C-CER,CHIP	2203-006361	SA
C609	C-CER,CHIP	2203-006824	SA
C610	C-CER,CHIP	2203-006324	SA
C611	C-CER,CHIP	2203-006423	SA
C621	C-CER,CHIP	2203-006824	SA
C622	C-CER,CHIP	2203-006260	SA

Main Electrical Parts List

Design LOC	Description	SEC Code	STATUS
C623	C-CER,CHIP	2203-006562	SA
C635	C-CER,CHIP	2203-006423	SA
C640	C-CER,CHIP	2203-000233	SA
C641	C-CER,CHIP	2203-000233	SA
C642	C-CER,CHIP	2203-000233	SA
C643	C-CER,CHIP	2203-000233	SA
C646	C-CER,CHIP	2203-006562	SA
C647	C-CER,CHIP	2203-006562	SA
C701	C-CER,CHIP	2203-006423	SA
C702	C-CER,CHIP	2203-006423	SA
C703	C-CER,CHIP	2203-006824	SA
C704	C-CER,CHIP	2203-000254	SA
C705	C-CER,CHIP	2203-006423	SA
C706	C-CER,CHIP	2203-006423	SA
C707	C-CER,CHIP	2203-006423	SA
C708	C-CER,CHIP	2203-006423	SA
C709	C-CER,CHIP	2203-000812	SA
C710	C-CER,CHIP	2203-006423	SA
C711	C-CER,CHIP	2203-006423	SA
C712	C-CER,CHIP	2203-000233	SA
C713	C-CER,CHIP	2203-000812	SA
C714	C-CER,CHIP	2203-005683	SA
C715	C-CER,CHIP	2203-006048	SA
C716	C-CER,CHIP	2203-006423	SA
C717	C-CER,CHIP	2203-000812	SA
C718	C-CER,CHIP	2203-006562	SA
C719	C-CER,CHIP	2203-006361	SA
C721	C-CER,CHIP	2203-006824	SA
C724	C-CER,CHIP	2203-006048	SA
C726	C-CER,CHIP	2203-006048	SA
C729	C-CER,CHIP	2203-006048	SA
C730	C-CER,CHIP	2203-001259	SA
C731	C-CER,CHIP	2203-000812	SA
C762	C-CER,CHIP	2203-001259	SA
C763	C-CER,CHIP	2203-000812	SA
C765	C-CER,CHIP	2203-006626	SA
C800	C-CER,CHIP	2203-006562	SA
C802	C-CER,CHIP	2203-006824	SA
C806	C-CER,CHIP	2203-000233	SA
C807	C-CER,CHIP	2203-000233	SA
C809	C-CER,CHIP	2203-000812	SA
C810	C-CER,CHIP	2203-006048	SA
C820	C-CER,CHIP	2203-005234	SA
C821	C-CER,CHIP	2203-005234	SA
C822	C-CER,CHIP	2203-005234	SA
C823	C-CER,CHIP	2203-005234	SA
C824	C-CER,CHIP	2203-005281	SA
C825	C-CER,CHIP	2203-005281	SA
C826	C-CER,CHIP	2203-005234	SA
C827	C-CER,CHIP	2203-005234	SA

Design LOC	Description	SEC Code	STATUS
C830	C-CER,CHIP	2203-000278	SA
C840	C-CER,CHIP	2203-000278	SA
C841	C-CER,CHIP	2203-001221	SA
C842	C-CER,CHIP	2203-006048	SA
C844	C-CER,CHIP	2203-006048	SA
C845	C-CER,CHIP	2203-001124	DNA
C850	C-CER,CHIP	2203-006048	SA
C851	C-CER,CHIP	2203-001221	SA
C853	C-CER,CHIP	2203-000233	SA
C854	INDUCTOR-SMD	2703-001748	SA
C855	C-CER,CHIP	2203-005288	SA
C856	C-CER,CHIP	2203-005288	SA
C857	C-CER,CHIP	2203-005288	SA
C860	C-CER,CHIP	2203-006562	SA
C861	C-CER,CHIP	2203-001124	DNA
C862	C-CER,CHIP	2203-001124	DNA
C865	C-CER,CHIP	2203-006048	SA
C900	C-CER,CHIP	2203-000714	SA
C901	C-CER,CHIP	2203-006562	SA
C902	C-CER,CHIP	2203-006824	SA
C903	C-CER,CHIP	2203-006048	SA
C904	C-CER,CHIP	2203-006562	SA
C905	C-CER,CHIP	2203-000714	SA
C910	C-CER,CHIP	2203-000425	SA
C911	C-CER,CHIP	2203-006048	SA
C912	C-CER,CHIP	2203-000425	SA
C913	C-CER,CHIP	2203-006257	SA
C915	C-CER,CHIP	2203-000812	SA
C916	C-CER,CHIP	2203-006257	SA
C917	C-CER,CHIP	2203-000233	SA
C918	C-CER,CHIP	2203-006562	SA
C919	C-CER,CHIP	2203-006824	SA
C922	C-CER,CHIP	2203-006257	SA
C923	C-CER,CHIP	2203-006824	SA
C924	C-CER,CHIP	2203-006257	SA
C925	C-CER,CHIP	2203-006257	SA
C926	C-CER,CHIP	2203-006562	SA
CN400	SOCKET-BOARD TO BOARD	3710-002081	SA
CN801	CONNECTOR-COAXIAL	3705-001225	SA
CN900	SOCKET-BOARD TO BOARD	3710-002081	SA
D301	DIODE-ARRAY	0407-001007	SA
D500	DIODE-SCHOTTKY	0404-001089	SA
D604	DIODE-ZENER	0403-001467	SA
F600	FILTER-EMI/ESD	2901-001361	SNA
F601	FILTER-EMI/ESD	2901-001361	SNA
F602	FILTER-EMI/ESD	2901-001361	SNA
F603	FILTER-EMI/ESD	2901-001361	SNA
F604	FILTER-EMI/ESD	2901-001361	SNA
F605	FILTER-EMI/ESD	2901-001337	SA
F800	DUPLEXER-FEM	2911-000050	SA

Design LOC	Description	SEC Code	STATUS
HDC600	HEADER-BOARD TO BOARD	3711-006101	SA
HDC603	HEADER-BOARD TO BOARD	3711-005296	SA
IFC500	SOCKET-INTERFACE	3710-002465	SA
L300	INDUCTOR-SMD	2703-000345	SA
L301	INDUCTOR-SMD	2703-002774	SA
L302	INDUCTOR-SMD	2703-002861	SA
L400	BEAD-SMD	3301-001438	SA
L401	BEAD-SMD	3301-001438	SA
L402	BEAD-SMD	3301-001729	SA
L403	BEAD-SMD	3301-001729	SA
L404	R-CHIP	2007-000171	SA
L500	BEAD-SMD	3301-001438	SA
L501	BEAD-SMD	3301-001438	SA
L502	BEAD-SMD	3301-001438	SA
L600	INDUCTOR-SMD	2703-002824	SA
L603	BEAD-SMD	3301-001438	SA
L700	INDUCTOR-SMD	2703-002653	SA
L801	C-CER,CHIP	2203-005444	SA
L802	INDUCTOR-SMD	2703-002368	SA
L805	INDUCTOR-SMD	2703-002170	SA
L806	INDUCTOR-SMD	2703-002586	SA
L807	INDUCTOR-SMD	2703-002204	SA
L808	INDUCTOR-SMD	2703-002485	SA
L811	INDUCTOR-SMD	2703-002314	SA
L900	INDUCTOR-SMD	2703-001723	SA
LED600	LED	0601-001905	SA
OSC100	CRYSTAL-SMD	2801-004466	SA
OSC101	CRYSTAL-SMD	2801-004189	SA
OSC400	OSCILLATOR-CLOCK	2804-001725	SA
OSC900	CRYSTAL-SMD	2801-004466	SA
PAM801	IC-POWER AMP	1201-002423	SA
Q600	FET-SILICON	0505-001518	SA
Q601	FET-SILICON	0505-001518	SA
Q602	FET-SILICON	0505-001518	SA
Q700	FET-SILICON	0505-001518	SA
R100	R-CHIP	2007-000171	SA
R103	R-CHIP	2007-000162	SA
R110	R-CHIP	2007-000171	SA
R111	R-CHIP	2007-000171	SA
R112	R-CHIP	2007-000141	SA
R113	R-CHIP	2007-000141	SA
R115	R-CHIP	2007-000170	SA
R116	R-CHIP	2007-000170	SA
R117	R-CHIP	2007-000170	SA
R120	R-CHIP	2007-000162	SA
R121	R-CHIP	2007-000171	SA
R207	R-CHIP	2007-008055	SA
R208	R-CHIP	2007-000152	SA
R209	R-CHIP	2007-000162	SA
R210	R-CHIP	2007-008055	SA

Design LOC	Description	SEC Code	STATUS
R211	R-CHIP	2007-008055	SA
R212	R-CHIP	2007-008055	SA
R214	R-CHIP	2007-008055	SA
R215	R-CHIP	2007-001291	SA
R216	R-CHIP	2007-008055	SA
R218	R-CHIP	2007-000173	SA
R219	R-CHIP	2007-009108	SA
R220	R-CHIP	2007-008486	SA
R301	R-CHIP	2007-000170	SA
R302	R-CHIP	2007-007107	SA
R304	R-CHIP	2007-000144	SA
R306	R-CHIP	2007-003014	SA
R307	R-CHIP	2007-000144	SA
R309	R-CHIP	2007-003014	SA
R311	R-CHIP	2007-008542	SA
R312	R-CHIP	2007-003014	SA
R313	R-CHIP	2007-000170	SA
R314	R-CHIP	2007-000162	SA
R315	R-CHIP	2007-000170	SA
R316	R-CHIP	2007-000148	SA
R317	R-CHIP	2007-000148	SA
R320	R-CHIP	2007-008055	SA
R321	R-CHIP	2007-008055	SA
R322	R-CHIP	2007-000170	SA
R327	R-CHIP	2007-001325	SA
R328	R-CHIP	2007-007318	SA
R329	R-CHIP	2007-007588	SA
R340	R-CHIP	2007-000164	SA
R341	R-CHIP	2007-000162	SA
R342	R-CHIP	2007-009155	SNA
R343	R-CHIP	2007-009155	SNA
R404	R-CHIP	2007-007538	SA
R405	R-CHIP	2007-007538	SA
R410	R-CHIP	2007-000174	SA
R414	R-CHIP	2007-007107	SA
R416	R-CHIP	2007-007318	SA
R417	R-CHIP	2007-007107	SA
R418	R-CHIP	2007-007137	SA
R420	R-CHIP	2007-007137	SA
R421	R-CHIP	2007-007318	SA
R428	R-CHIP	2007-000162	SA
R500	R-CHIP	2007-007528	SA
R501	R-CHIP	2007-007528	SA
R502	R-CHIP	2007-008055	SA
R503	R-CHIP	2007-009108	SA
R506	R-CHIP	2007-008542	SA
R507	R-CHIP	2007-008542	SA
R508	R-CHIP	2007-008419	SA
R509	R-CHIP	2007-008419	SA
R510	R-CHIP	2007-008419	SA

Main Electrical Parts List

Design LOC	Description	SEC Code	STATUS
R511	R-CHIP	2007-008542	SA
R515	R-CHIP	2007-009170	SA
R516	R-CHIP	2007-008055	SA
R525	R-CHIP	2007-008531	SA
R526	R-CHIP	2007-008531	SA
R530	R-CHIP	2007-007107	SA
R531	R-CHIP	2007-007107	SA
R532	R-CHIP	2007-007489	SA
R533	R-CHIP	2007-007107	SA
R534	R-CHIP	2007-007334	SA
R535	R-CHIP	2007-008055	SA
R601	R-CHIP	2007-008055	SA
R602	R-CHIP	2007-008542	SA
R608	R-CHIP	2007-008542	SA
R610	R-CHIP	2007-008055	SA
R611	R-CHIP	2007-008542	SA
R612	R-CHIP	2007-008055	SA
R613	R-CHIP	2007-008542	SA
R614	R-CHIP	2007-008055	SA
R617	R-CHIP	2007-009154	SNA
R618	R-CHIP	2007-000162	SA
R620	R-CHIP	2007-000157	SA
R625	R-CHIP	2007-007014	SA
R626	R-CHIP	2007-007014	SA
R627	R-CHIP	2007-007014	SA
R628	R-CHIP	2007-007014	SA
R629	R-CHIP	2007-007014	SA
R630	R-CHIP	2007-001307	SA
R631	R-CHIP	2007-001298	SA
R632	R-CHIP	2007-001298	SA
R633	R-CHIP	2007-000140	SA
R634	R-CHIP	2007-000140	SA
R635	R-CHIP	2007-000140	SA
R636	R-CHIP	2007-000162	SA
R637	R-CHIP	2007-008516	SA
R701	R-CHIP	2007-000148	SA
R702	R-CHIP	2007-008055	SA
R703	R-CHIP	2007-008055	SA
R704	R-CHIP	2007-000171	SA
R705	R-CHIP	2007-000162	SA
R714	R-CHIP	2007-000242	SA
R715	R-CHIP	2007-000242	SA
R727	R-CHIP	2007-000143	SA
R730	R-CHIP	2007-007573	SA
R731	R-CHIP	2007-008354	SA
R732	R-CHIP	2007-007107	SA
R733	R-CHIP	2007-007107	SA
R735	R-CHIP	2007-000148	SA
R800	R-CHIP	2007-001313	SA
R802	R-CHIP	2007-000140	SA

Design LOC	Description	SEC Code	STATUS
R803	R-CHIP	2007-000171	SA
R804	R-CHIP	2007-000171	SA
R807	R-CHIP	2007-000171	SA
R808	R-CHIP	2007-000171	SA
R871	R-CHIP	2007-000171	SA
R872	R-CHIP	2007-001284	SA
R900	R-CHIP	2007-000162	SA
R901	R-CHIP	2007-000163	SA
R903	R-CHIP	2007-000163	SA
R904	R-CHIP	2007-000162	SA
R905	R-CHIP	2007-007100	SA
R906	R-CHIP	2007-000171	SA
R907	R-CHIP	2007-000162	SA
RFS00	CONNECTOR-COAXIAL	3705-001358	SA
SD600	CONNECTOR-CARD EDGE	3709-001453	SA
SLC602	CONNECTOR-FPC/FFC/PIC	3708-002338	SA
TA344	C-TA,CHIP	2404-001474	SA
TA345	C-TA,CHIP	2404-001381	SA
TA401	C-TA,CHIP	2404-001381	SA
TA403	C-TA,CHIP	2404-001381	SA
TA404	C-TA,CHIP	2404-001474	SA
TA406	C-TA,CHIP	2404-001381	SA
TA409	C-TA,CHIP	2404-001381	SA
TA426	C-TA,CHIP	2404-001381	SA
TA441	C-TA,CHIP	2404-001465	SA
TA446	C-CER,CHIP	2203-006824	SA
TA503	C-TA,CHIP	2404-001381	SA
TA504	C-TA,CHIP	2404-001381	SA
TA720	C-TA,CHIP	2404-001377	SA
TA808	C-TA,CHIP	2404-001474	SA
TA914	C-TA,CHIP	2404-001381	SA
TAC100	SWITCH-TACT	3404-001303	SA
TCX800	OSCILLATOR-VCTCXO	2809-001303	SA
TH700	THERMISTOR-NTC	1404-001221	SA
TR201	TR-DIGITAL	0504-000168	SA
TR301	TR-DIGITAL	0504-000167	SA
TR302	FET-SILICON	0505-001165	SA
TR303	TR-DIGITAL	0504-000167	SA
U200	IC-CMOS LOGIC	0801-002237	SA
U202	IC-CMOS LOGIC	0801-003052	SA
U203	IC-CMOS LOGIC	0801-003031	SA
U204	IC-CMOS LOGIC	0801-002529	SA
U205	IC-CMOS LOGIC	0801-003016	SA
U208	IC-CMOS LOGIC	0801-003031	SA
U300	IC-MULTI REG.	1203-003643	SA
U301	IC-MULTI REG.	1203-004435	SA
U302	IC-DC/DC CONVERTER	1203-003500	SA
U304	IC-MULTI REG.	1203-003664	SA
U305	IC-MULTI REG.	1203-003664	SA
U306	IC-MULTI REG.	1203-004523	SA

Design LOC	Description	SEC Code	STATUS
U307	IC-CMOS LOGIC	0801-002529	SA
U308	IC-VOL. DETECTOR	1203-002789	SA
U309	IC-BATTERY	1203-003823	SA
U310	IC-VOL. DETECTOR	1203-002832	SA
U311	IC-MULTI REG.	1203-004428	SA
U312	IC-SWITCH	1205-002874	SA
U400	IC-AUDIO AMP	1201-002240	SA
U402	IC-VOLTAGE COMP.	1202-001079	SA
U403	IC-ANALOG SWITCH	1001-001371	SA
U404	IC-ANALOG MULTIPLEX	1001-001428	SA
U500	IC-ANALOG SWITCH	1001-001410	SA
U501	IC-ANALOG SWITCH	1001-001410	SA
U502	IC-D/A CONVERTER	1002-001488	SA
U600	IC-DC/DC CONVERTER	1203-004172	SA
U601	IC-POSI.FIXED REG.	1203-003815	SA
U604	IC-POSI.FIXED REG.	1203-003737	SA
U605	BLUETOOTH MODULE	4709-001494	SA
U704	IC-POSI.FIXED REG.	1203-003737	SA
U705	IC-DC/DC CONVERTER	1203-003545	SA
U706	IC-ANALOG SWITCH	1001-001231	SA
U800	IC-POSI.FIXED REG.	1203-004507	SA
U801	IC-CMOS LOGIC	0801-003016	SA
U900	IC-AUDIO AMP	1201-002284	SA
U901	IC-CMOS LOGIC	0801-003026	SA
U902	IC-POWER SUPERVISOR	1203-003882	SA
U910	C-CER,CHIP	2203-000812	SA
U911	C-CER,CHIP	2203-000233	SA
UCD401	IC-CODEC	1205-002720	SA
UCP100	IC-MICROPROCESSOR	0902-001927	SA
UCP700	IC-COMM. CONTROLLER	1205-002757	SA
UME206	IC-SRAM	1106-001519	SA
UME207	IC-MCP	1108-000054	SA
UME702	IC-MCP	1108-000059	SA
UPL802	IC-TRANSCEIVER	1205-003093	SA
V500	THERMISTOR-NTC	1404-001221	SA
ZD100	DIODE-TVS	0406-001210	SA
ZD300	DIODE-ZENER	0403-001547	SA
ZD303	DIODE-TVS	0406-001210	SA
ZD368	DIODE-ZENER	0403-001427	SA
ZD400	DIODE-TVS	0406-001254	SA
ZD401	DIODE-TVS	0406-001254	SA
ZD405	DIODE-TVS	0406-001201	SA
ZD406	DIODE-TVS	0406-001201	SA
ZD407	DIODE-TVS	0406-001215	SA
ZD501	DIODE-TVS	0406-001210	SA
ZD502	DIODE-TVS	0406-001210	SA
ZD504	DIODE-TVS	0406-001241	SA
ZD505	DIODE-TVS	0406-001231	SA
ZD506	DIODE-TVS	0406-001231	SA
ZD507	DIODE-TVS	0406-001231	SA

Design LOC	Description	SEC Code	STATUS
ZD508	DIODE-TVS	0406-001231	SA
ZD509	DIODE-TVS	0406-001231	SA
ZD510	DIODE-TVS	0406-001231	SA
ZD600	DIODE-TVS	0406-001241	SA
ZD601	DIODE-TVS	0406-001241	SA
ZD602	DIODE-TVS	0406-001254	SA
ZD603	DIODE-TVS	0406-001254	SA
ZD604	DIODE-TVS	0406-001254	SA
ZD605	DIODE-TVS	0406-001210	SA
ZD606	DIODE-TVS	0406-001201	SA
ZD607	DIODE-TVS	0406-001215	SA
ZD608	DIODE-TVS	0406-001215	SA
ZD609	DIODE-TVS	0406-001254	SA
ZD610	DIODE-TVS	0406-001254	SA

7. Block Diagrams

: 2006. 06.29.(REV0.0A)

: 5

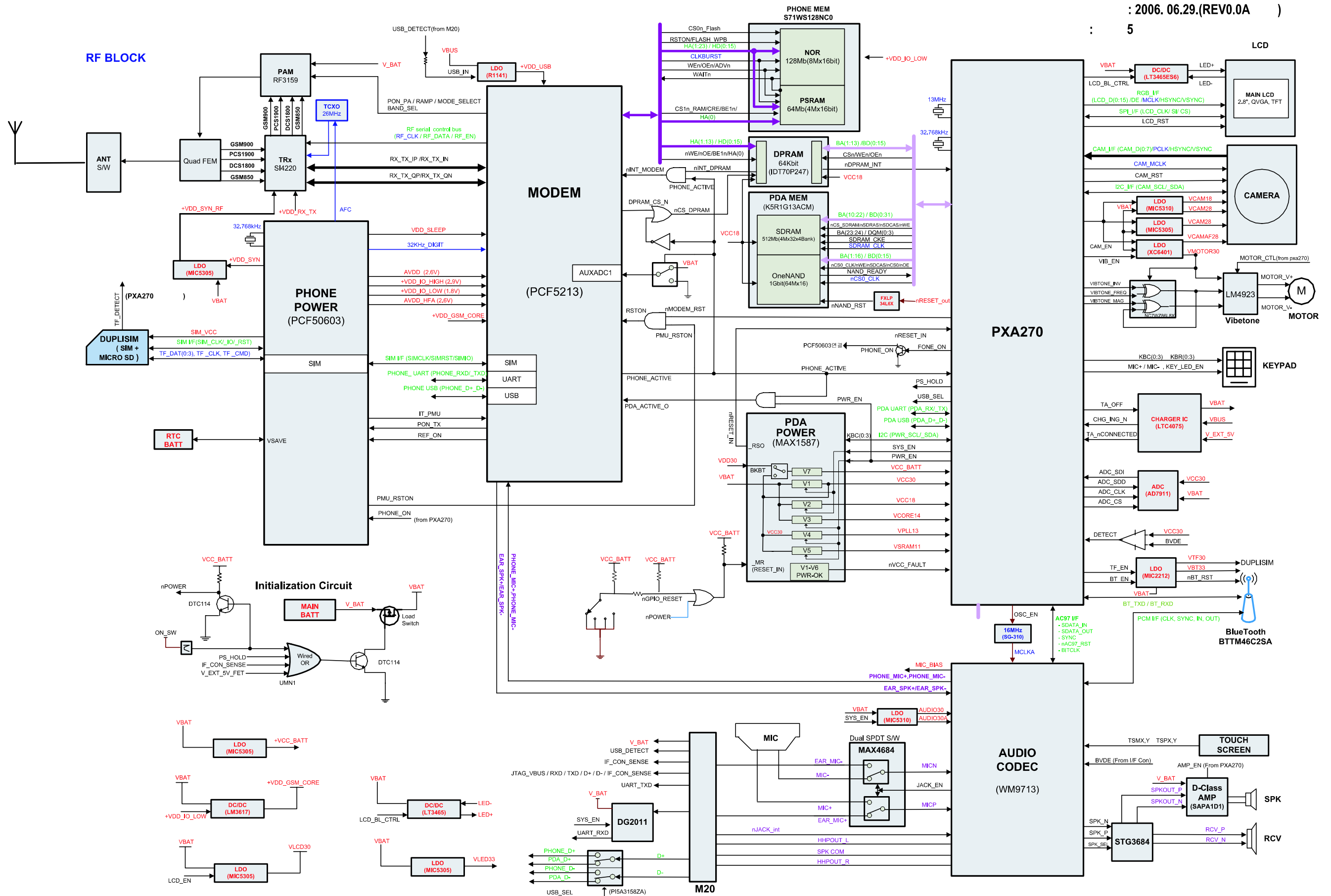

Bottom

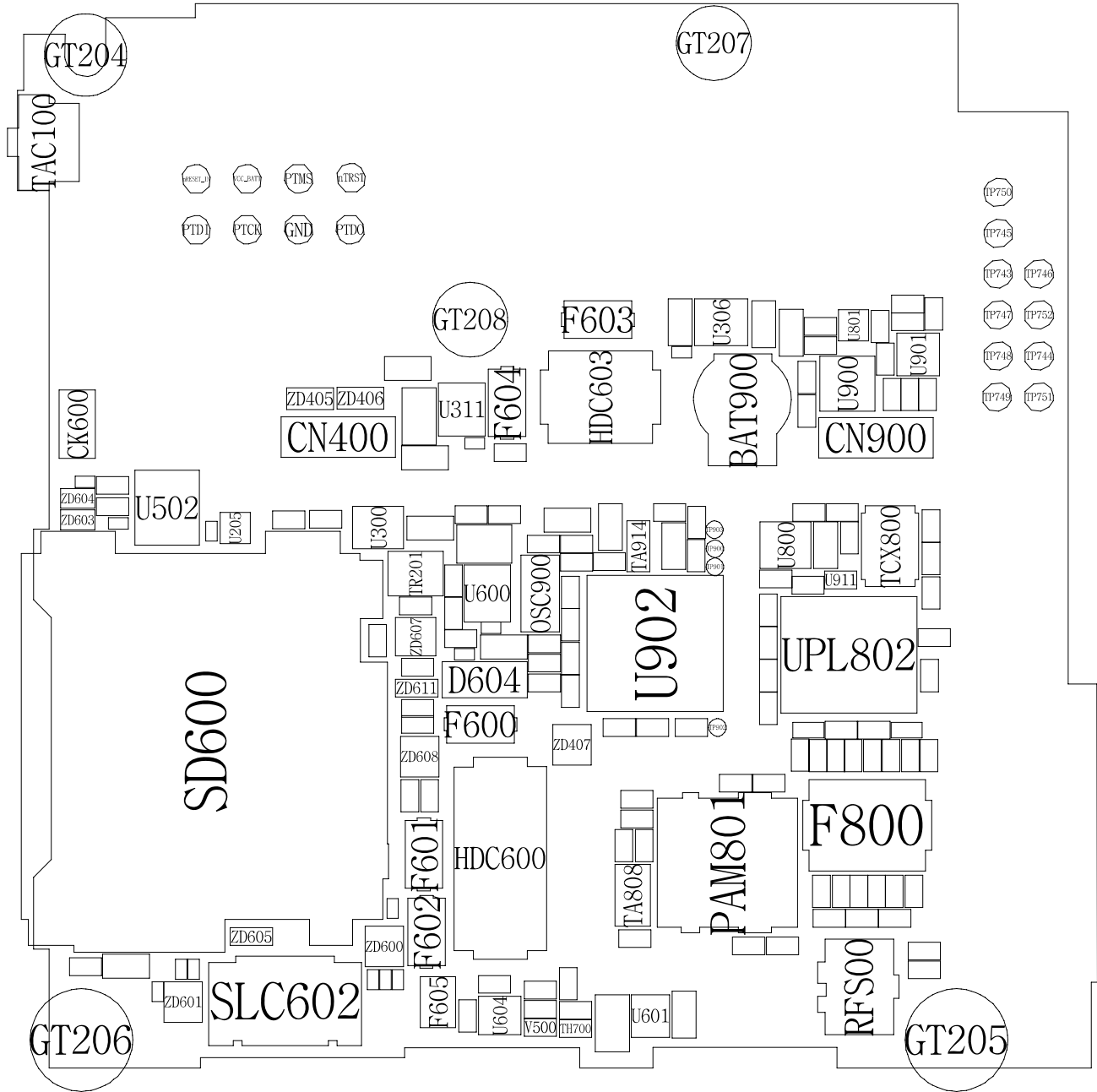

9. Flow Chart of Troubleshooting

9-1. Power On

9-1-1. PDA Part

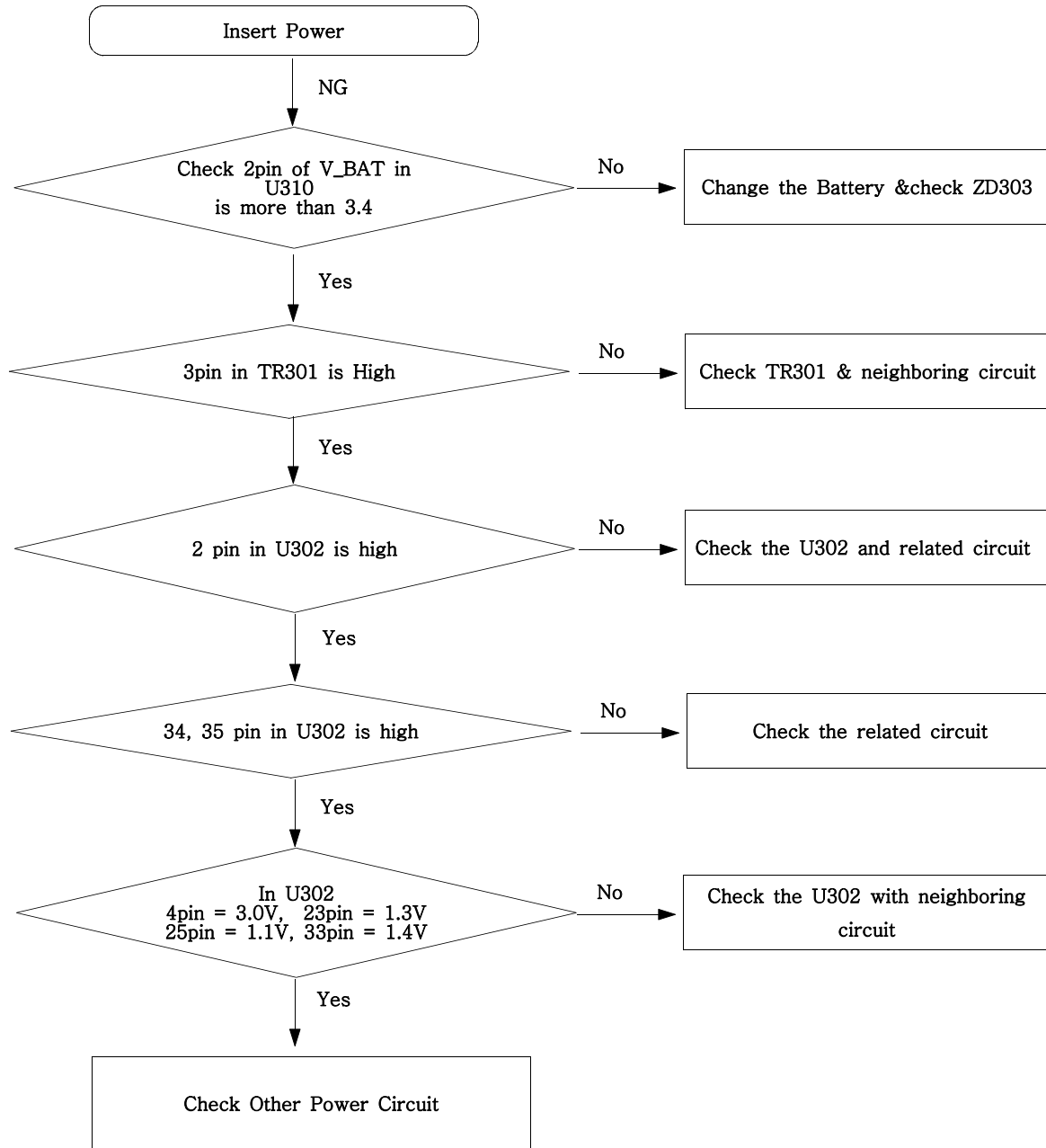

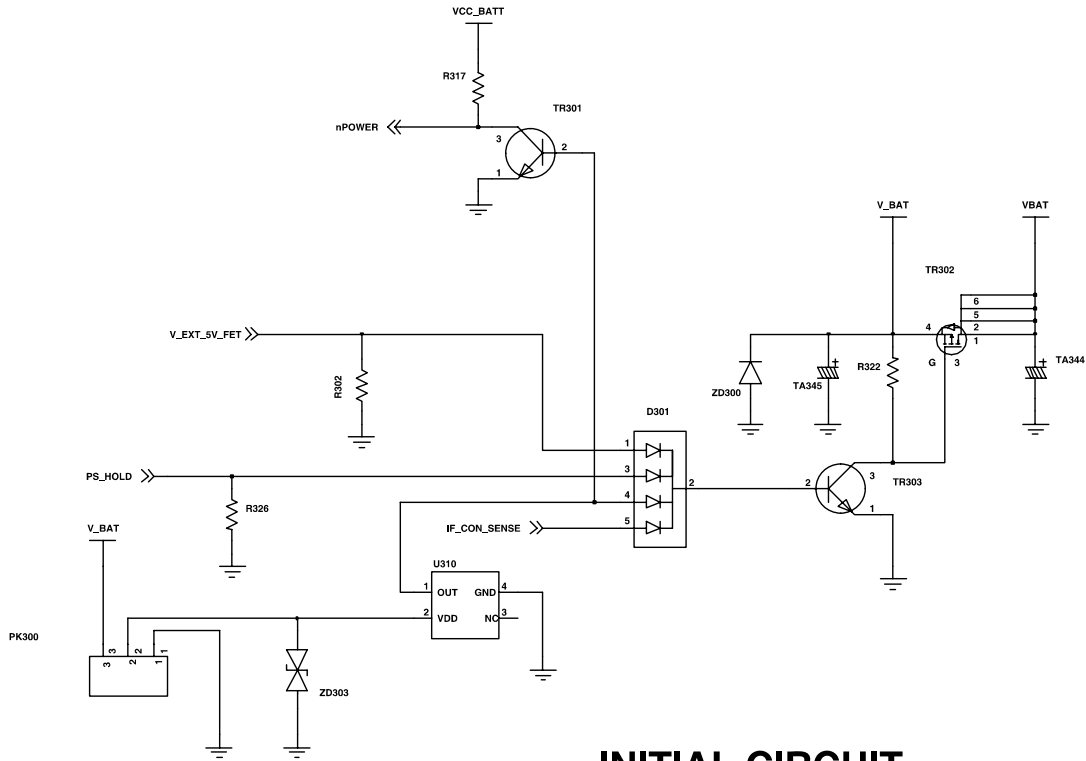

INITIAL CIRCUIT

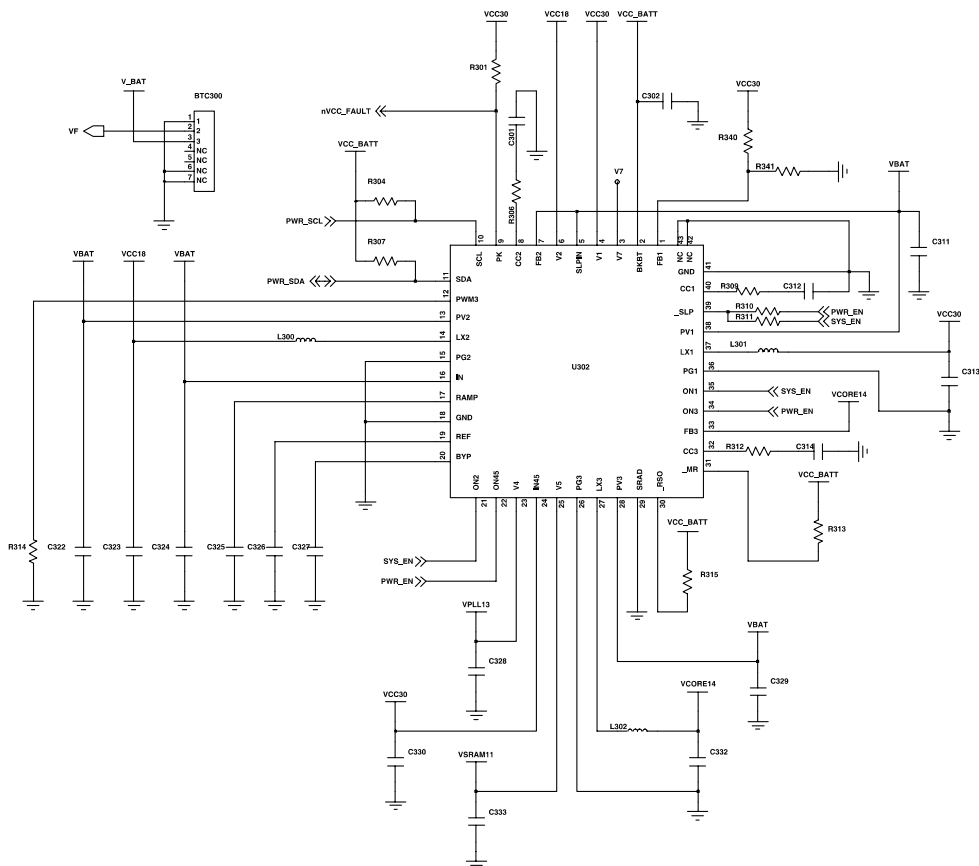

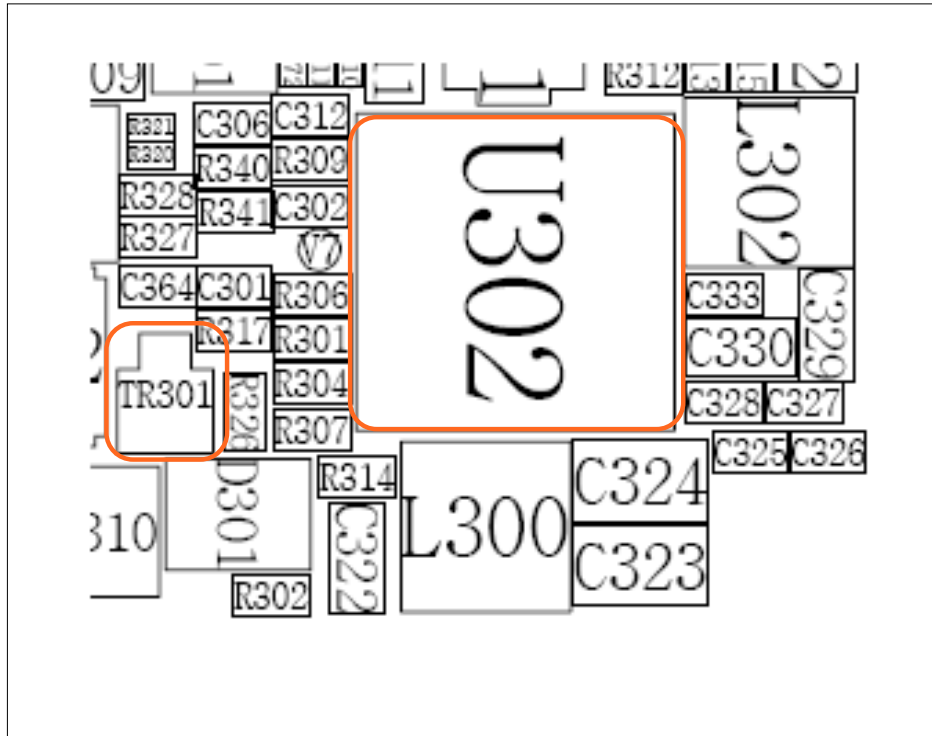

9-1-2. Phone Part

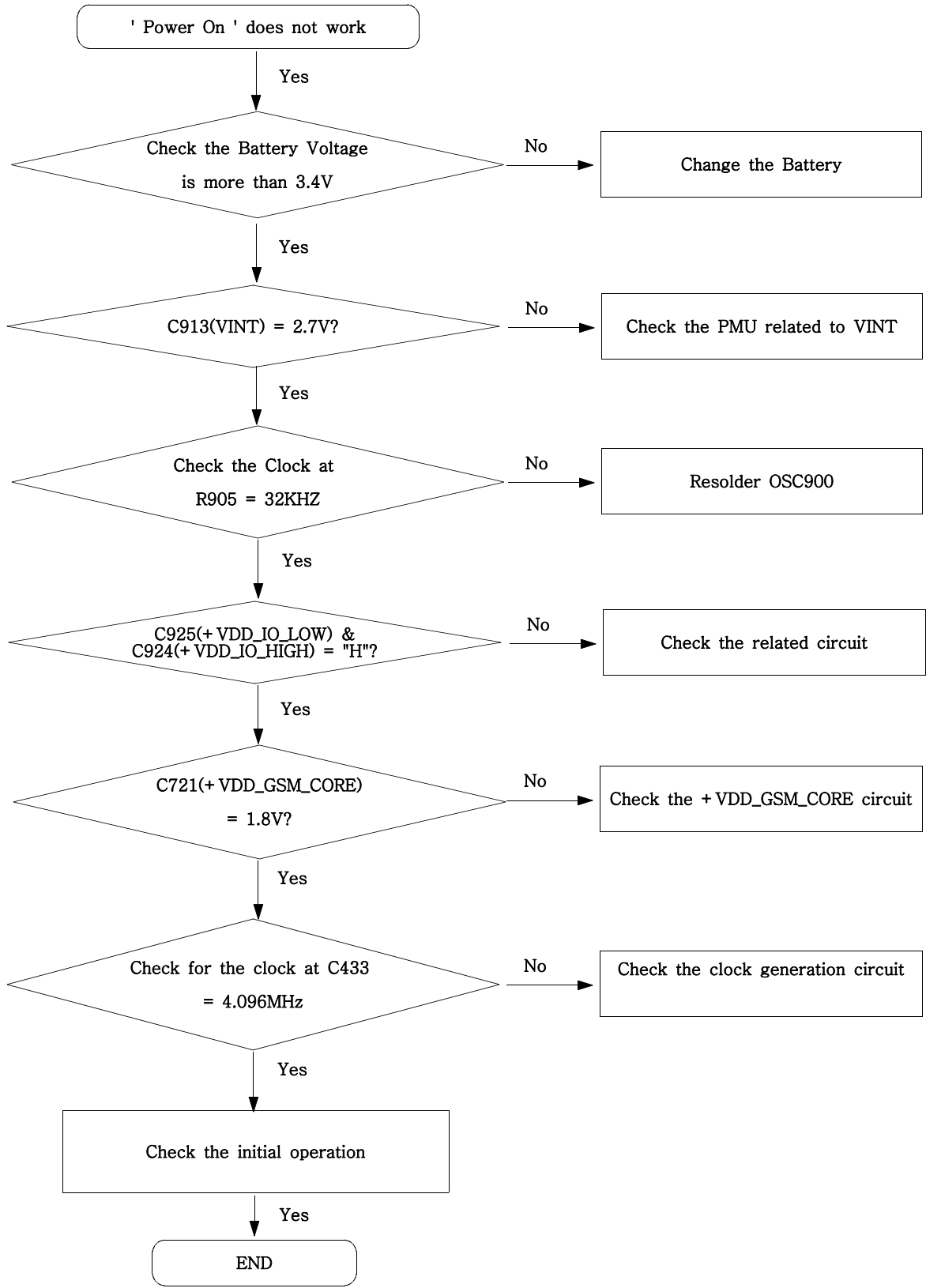

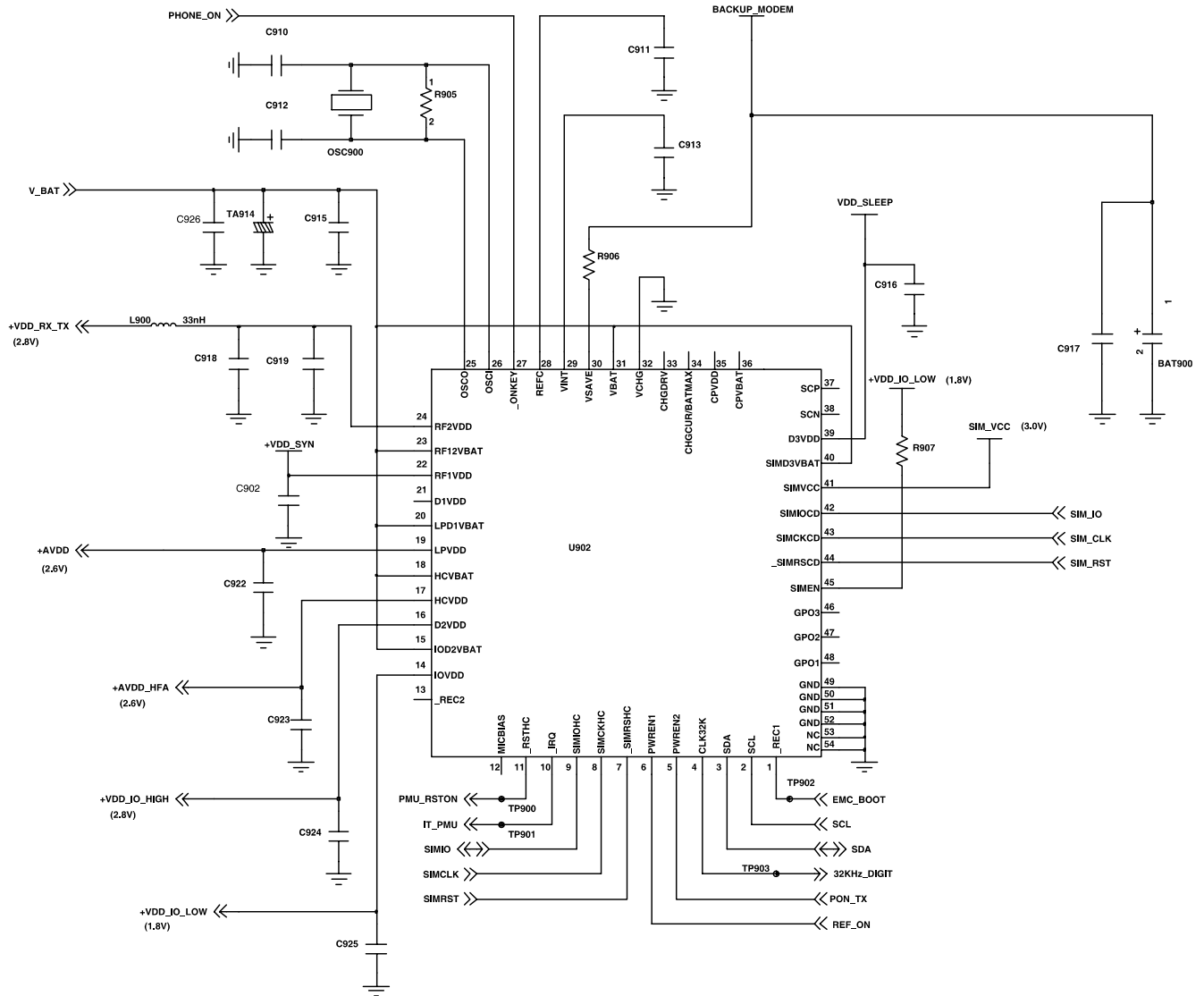

9-2. Initial

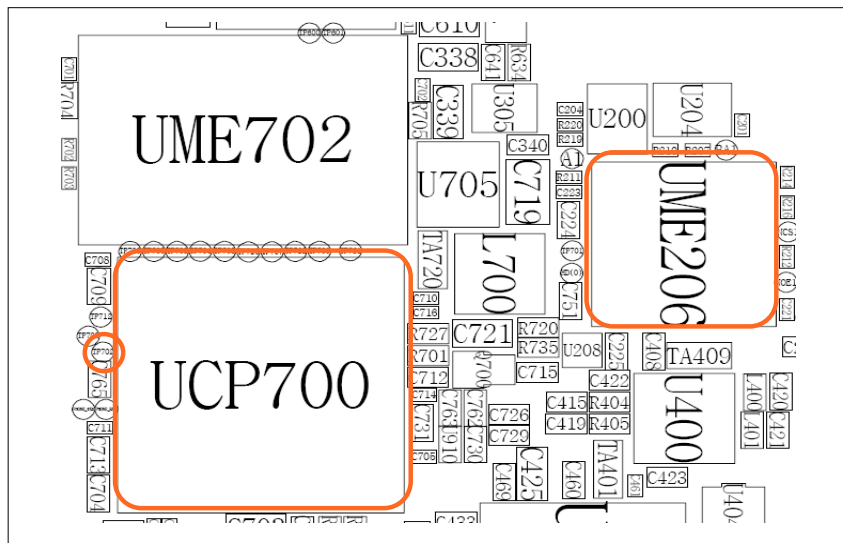
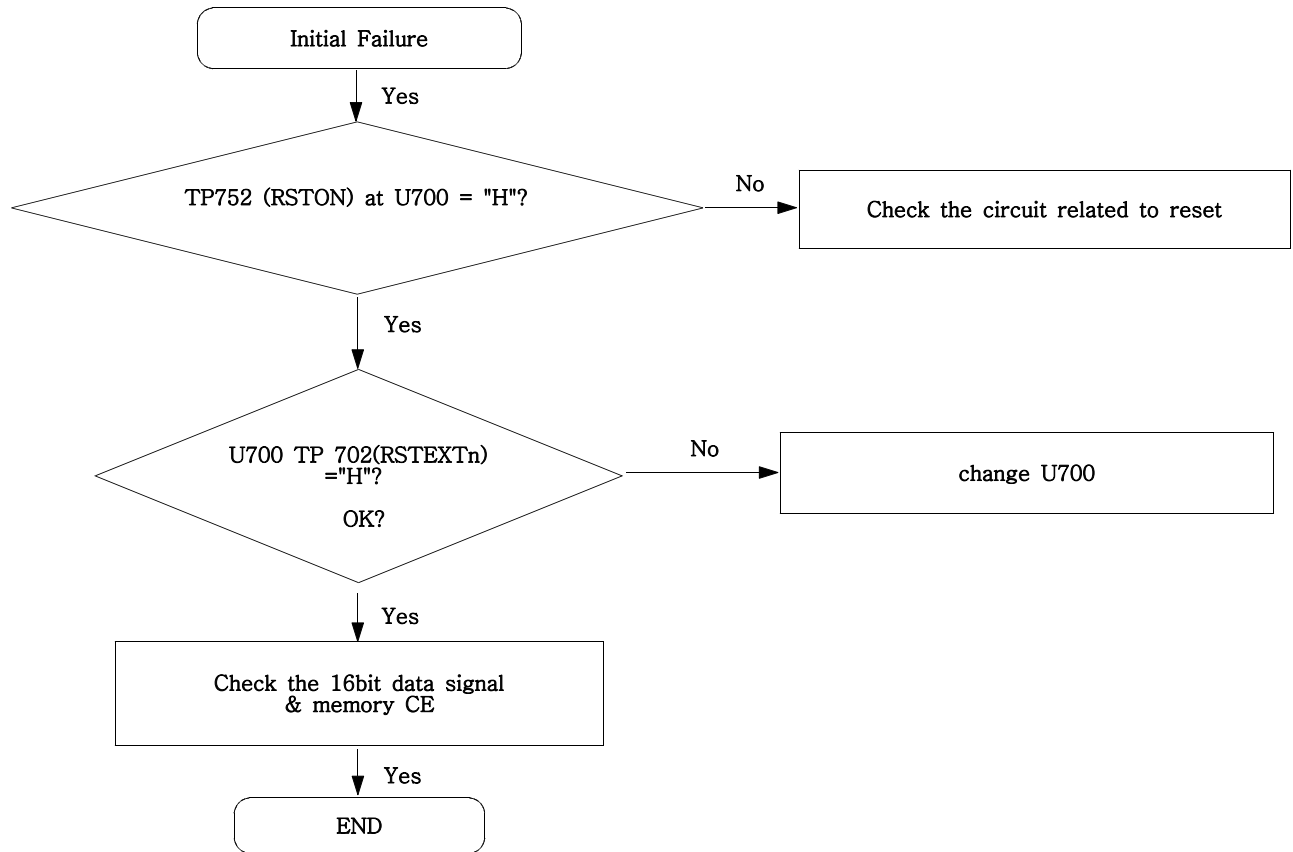

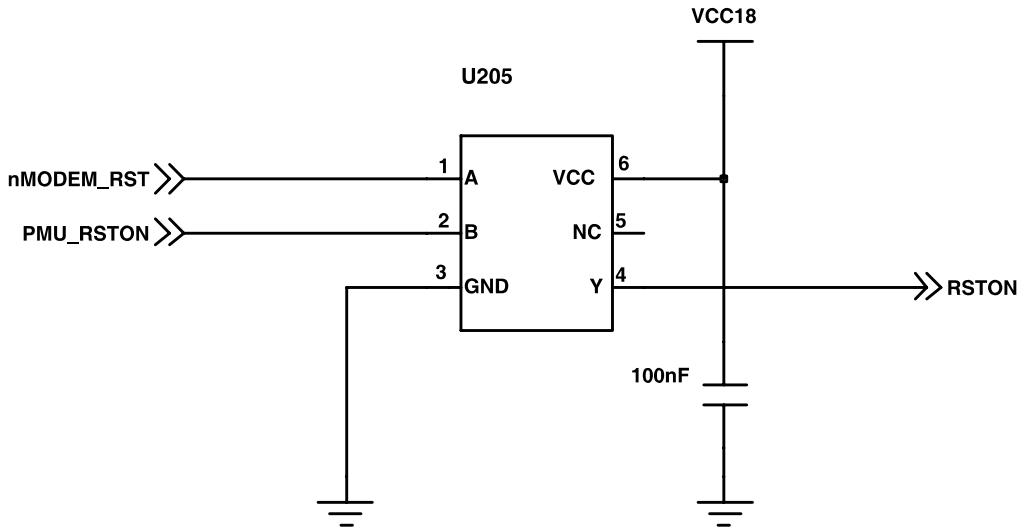
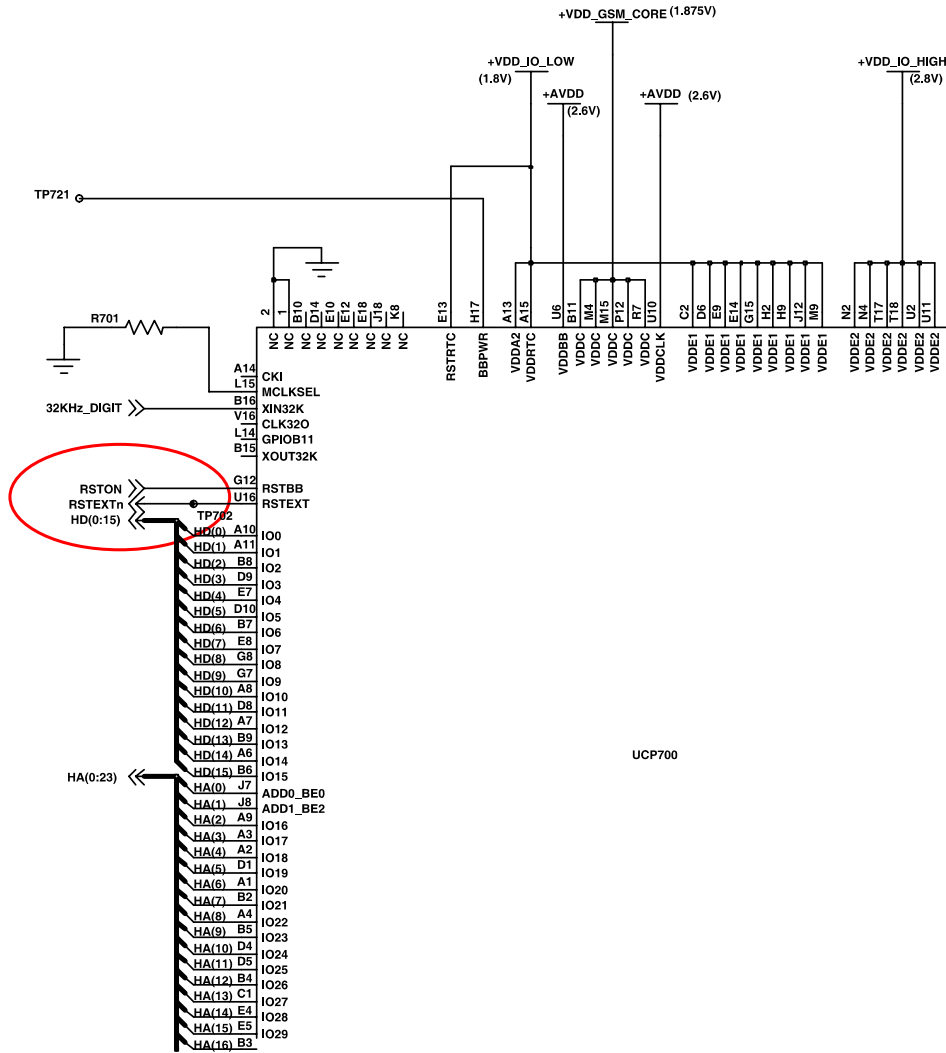

9-3. Charging Part

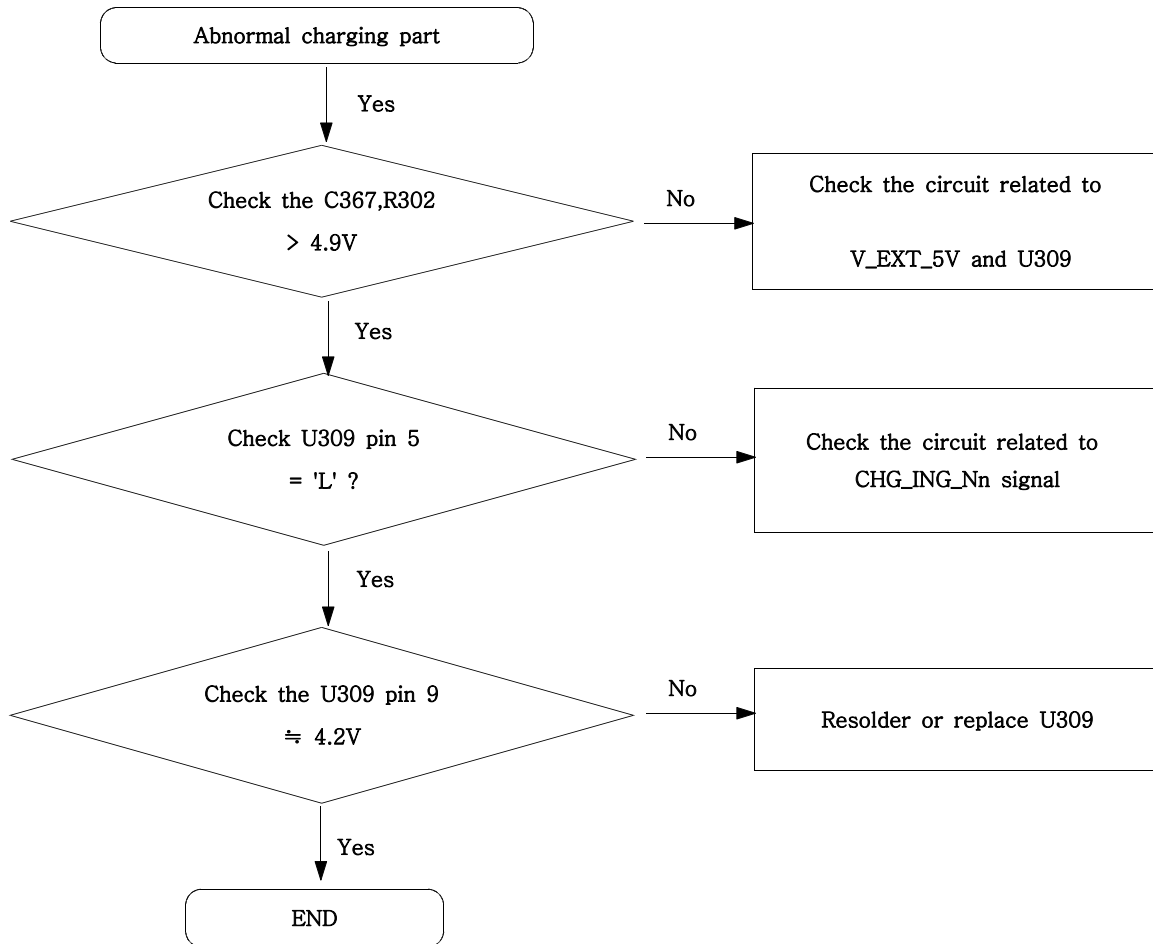

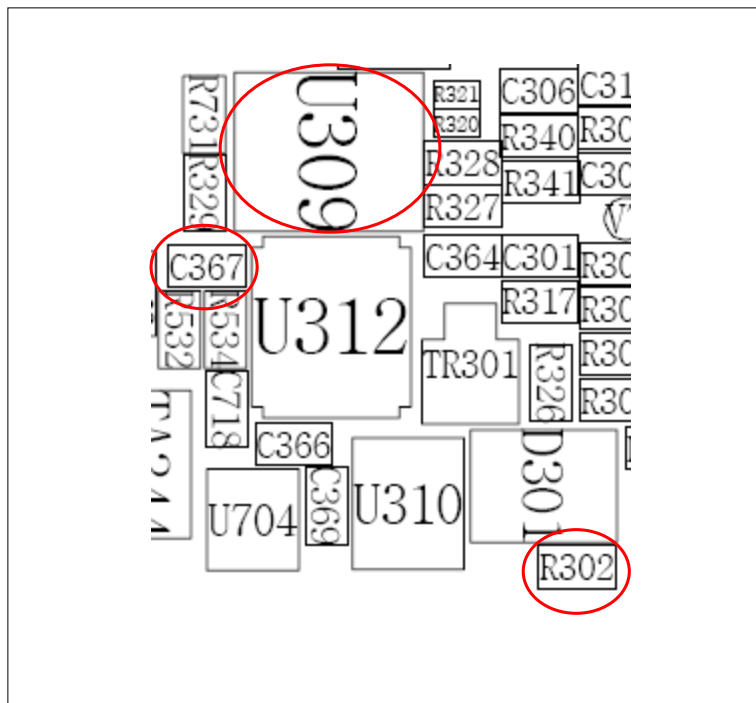
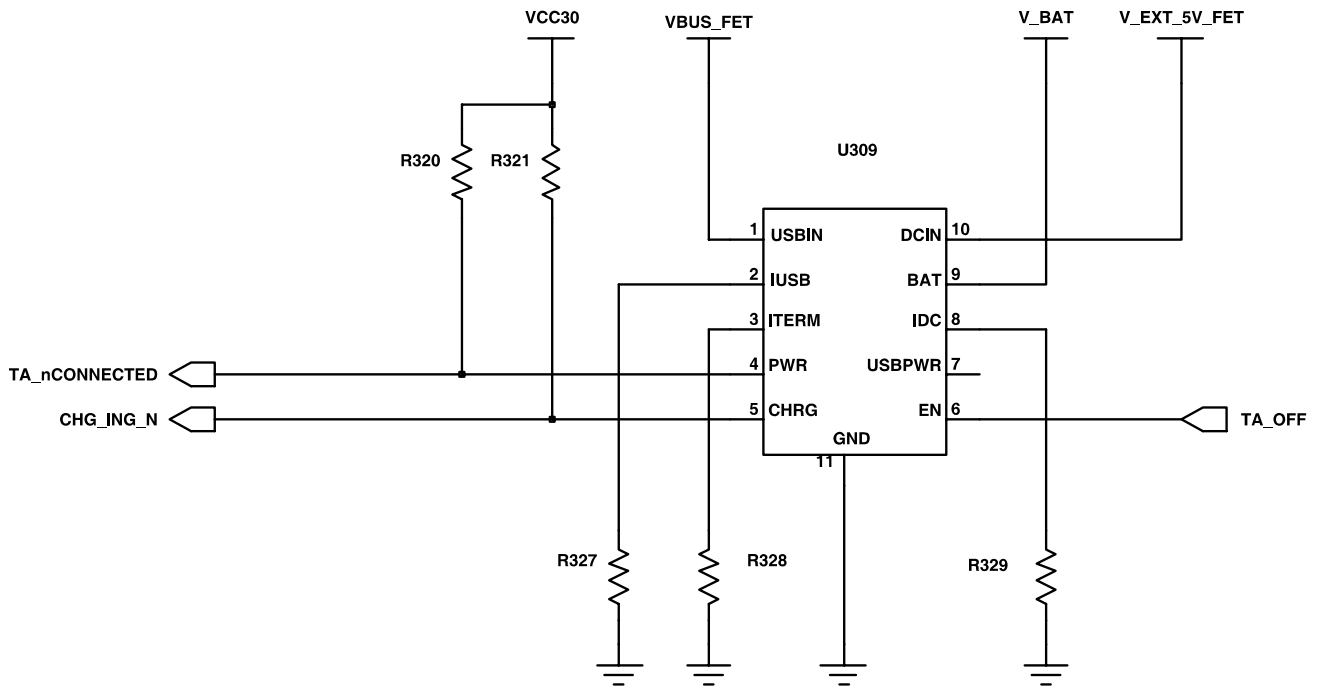

9-4. Sim Part

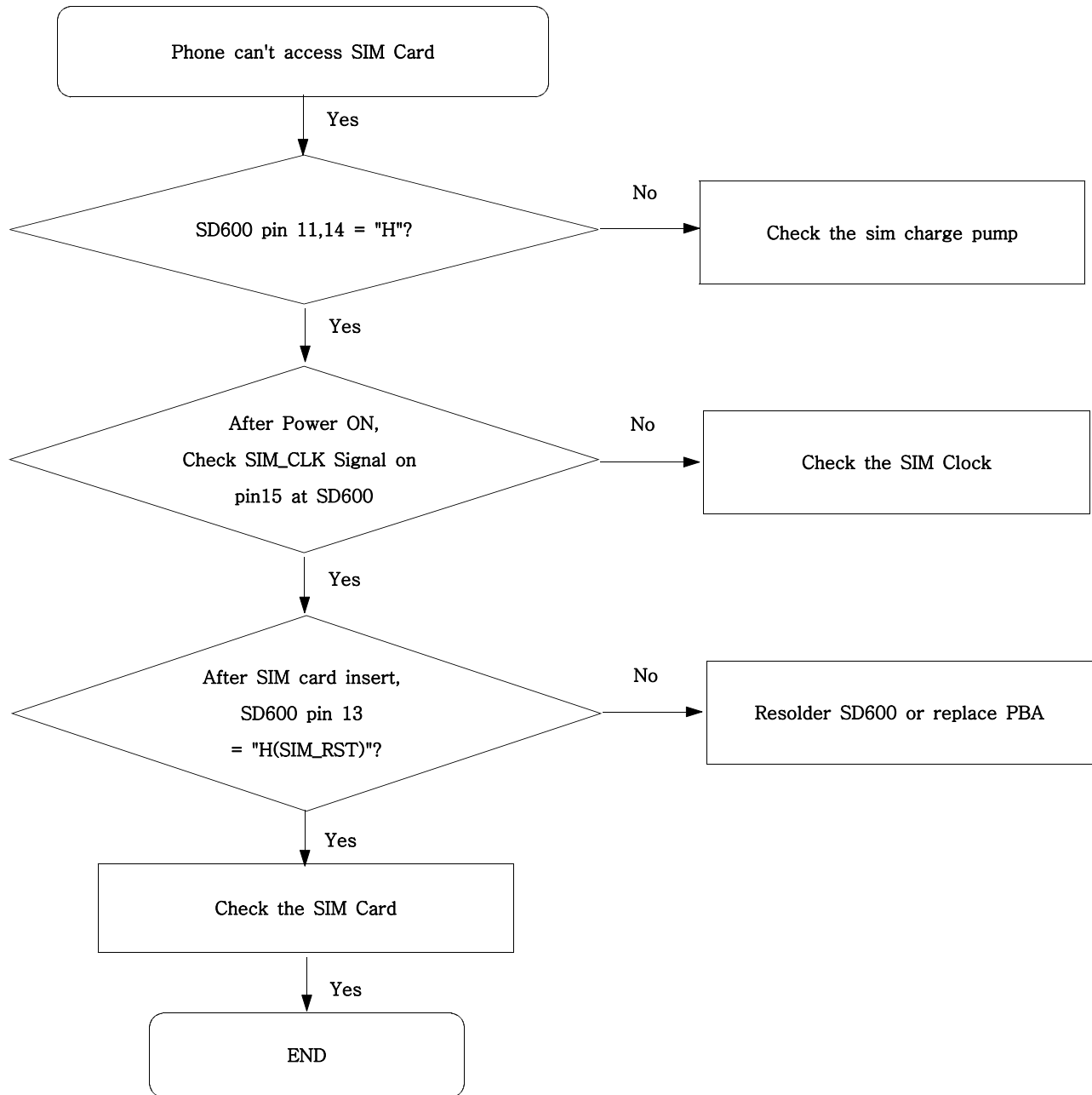

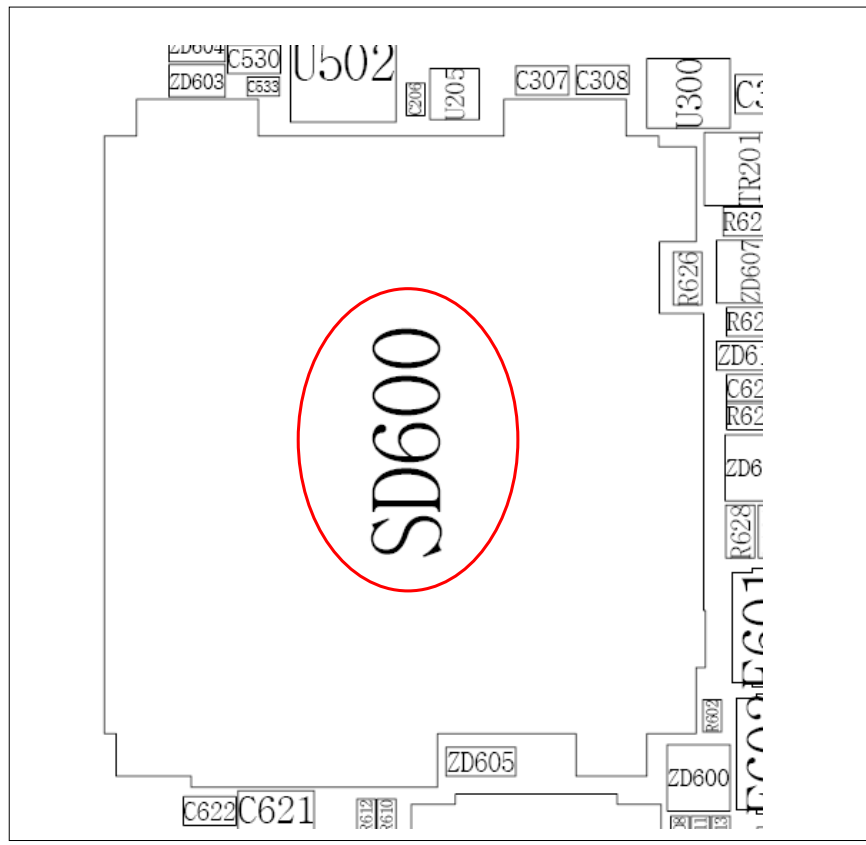
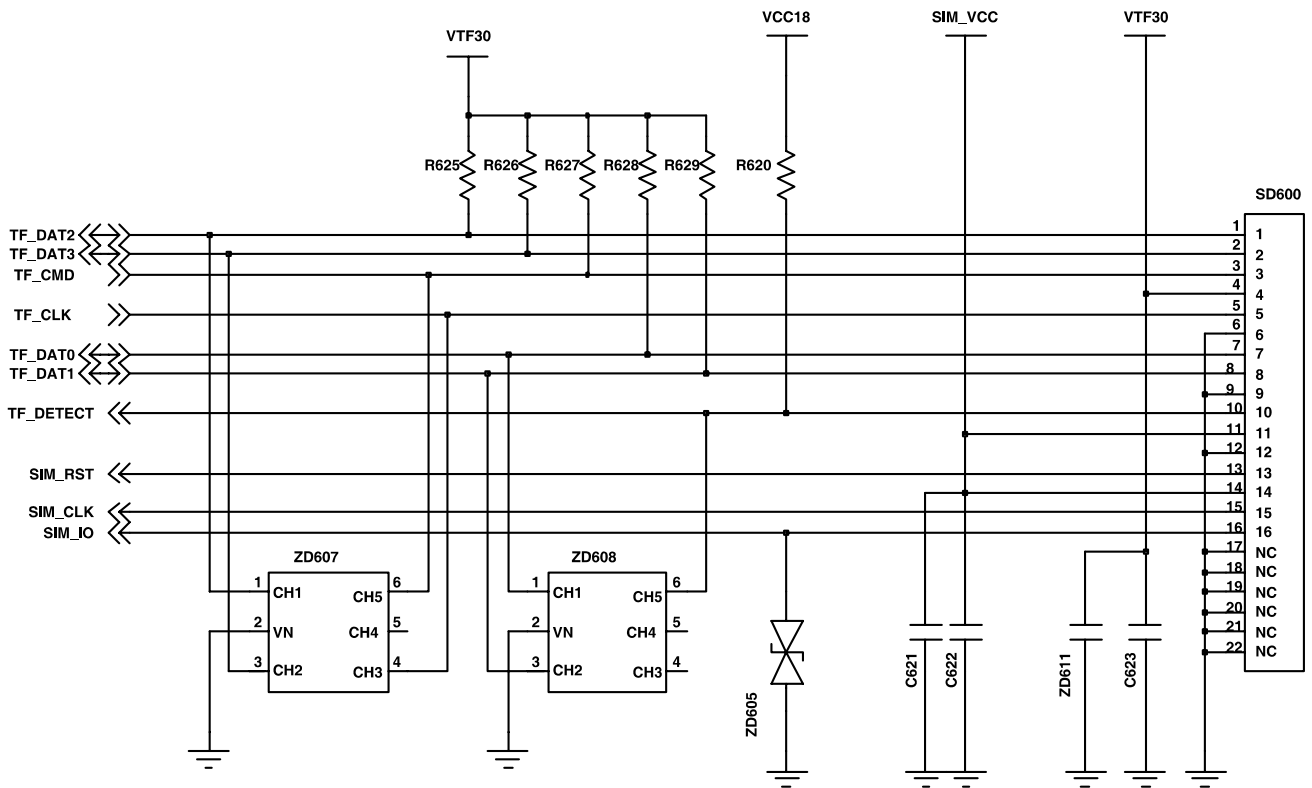

9-5. Microphone Part

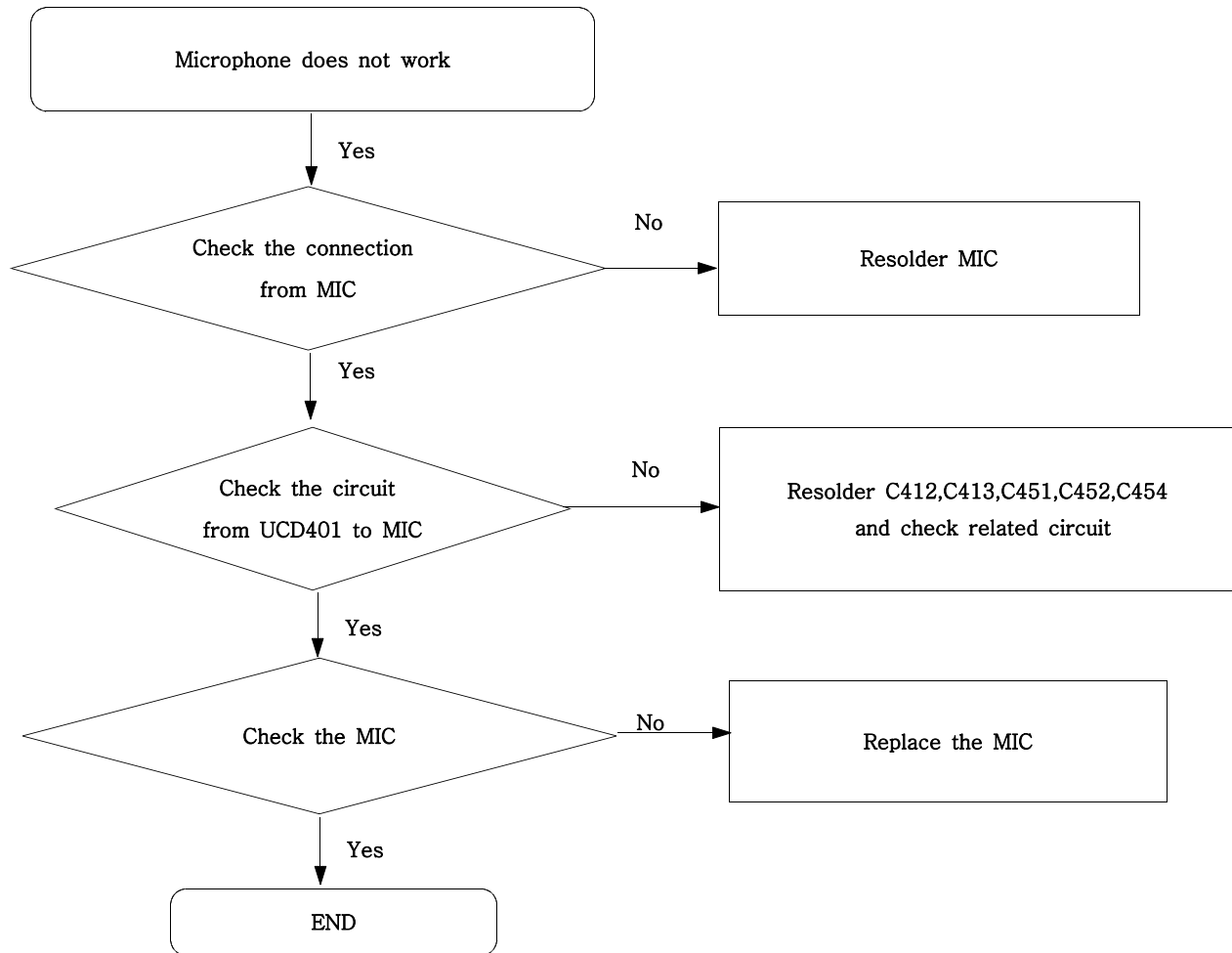

9-6. Speaker Part(Melody)

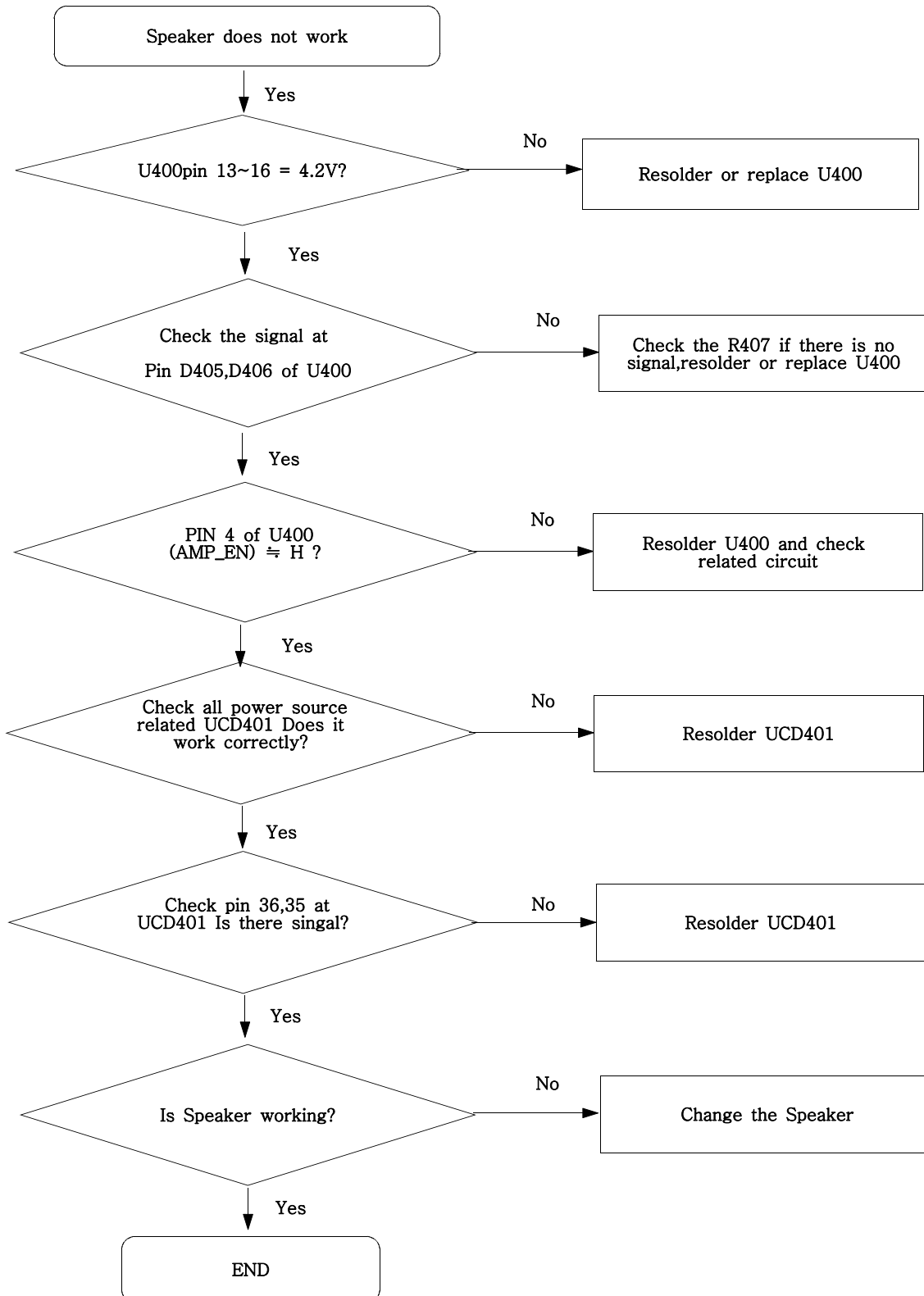

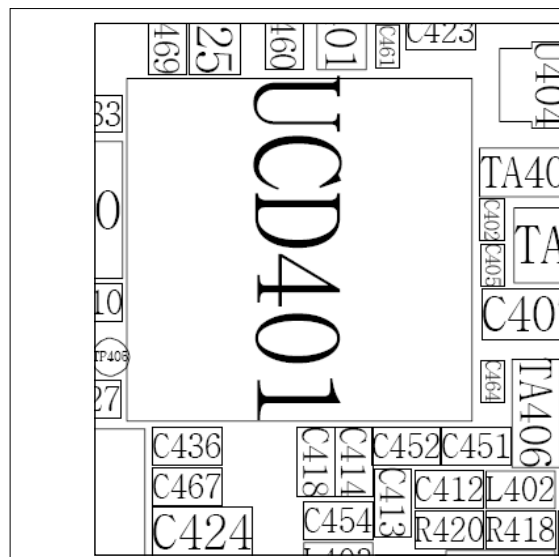
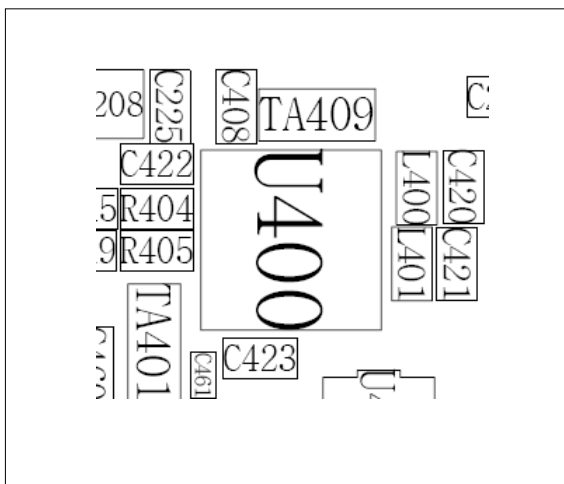
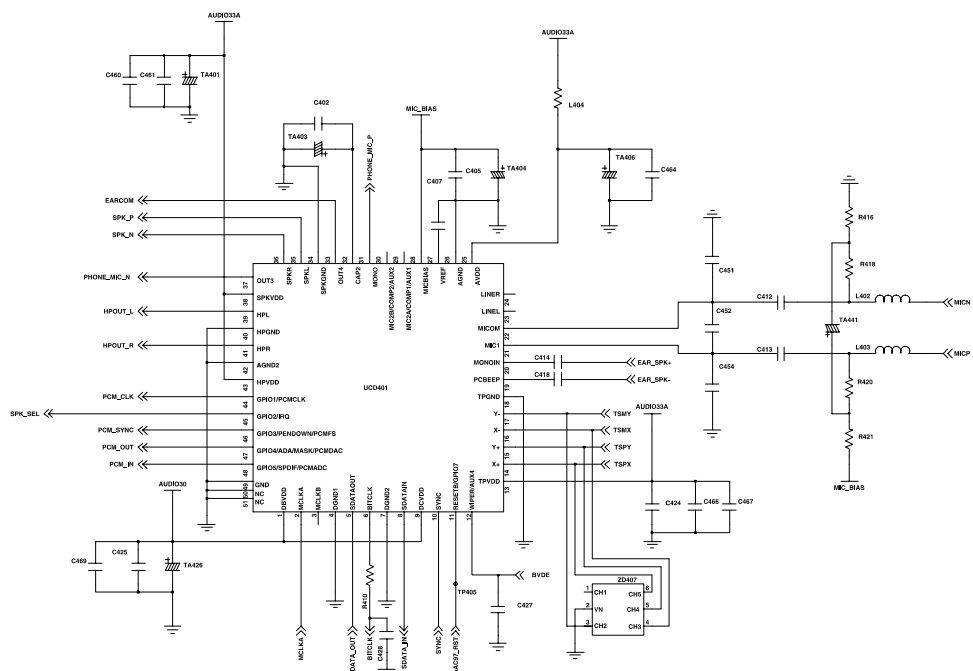
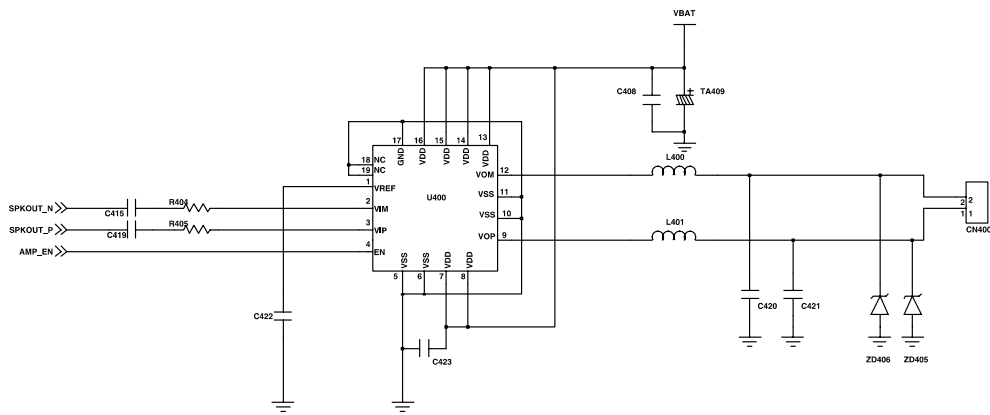

9-7. Key Data Input

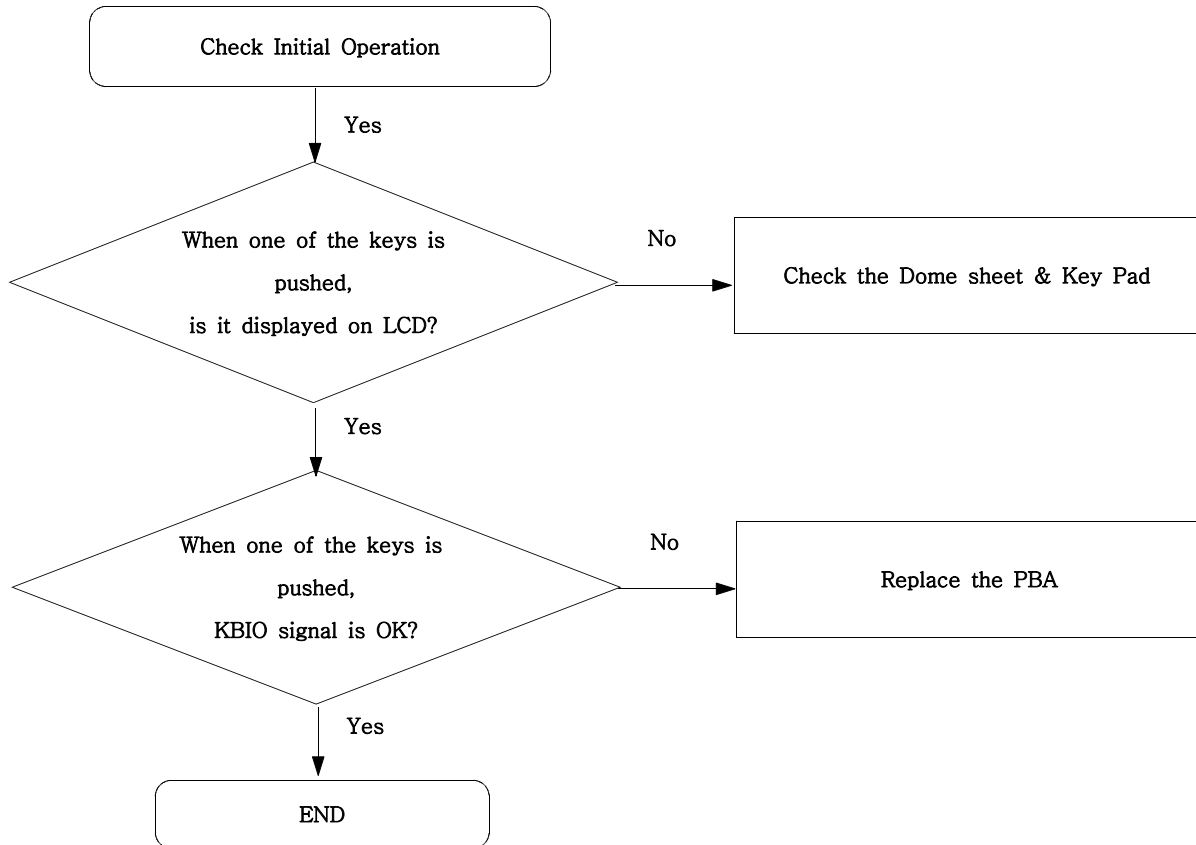

9-8. Receiver Part

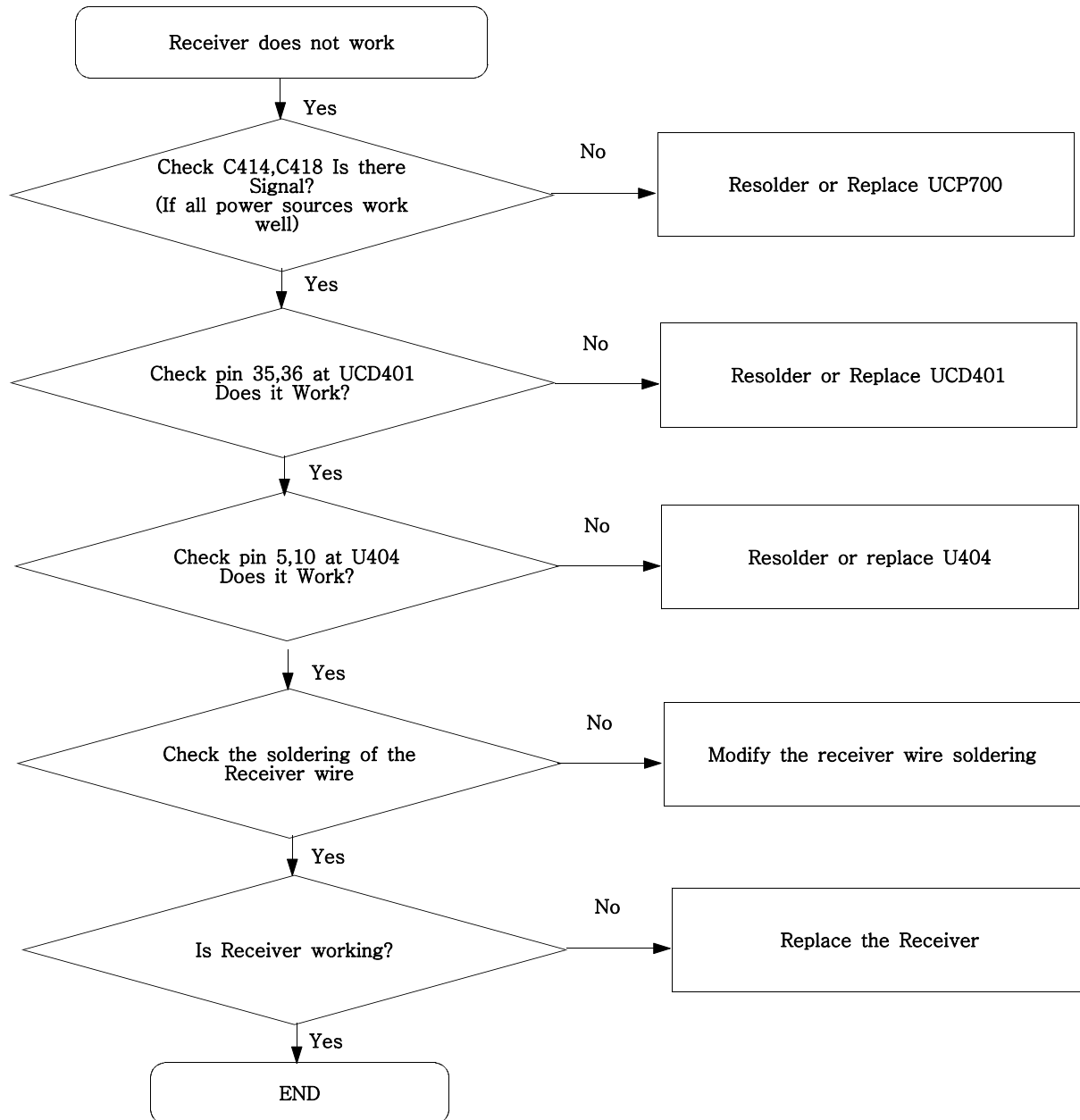

9-9. Back Light (for Color Main LCD)

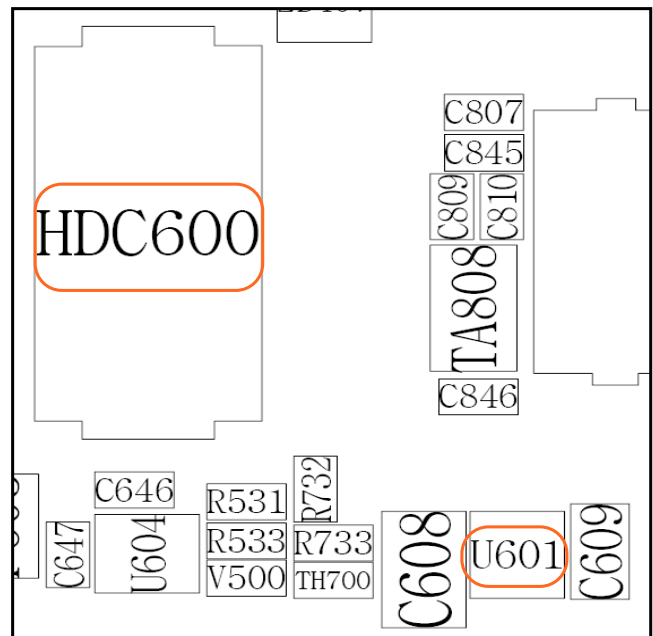
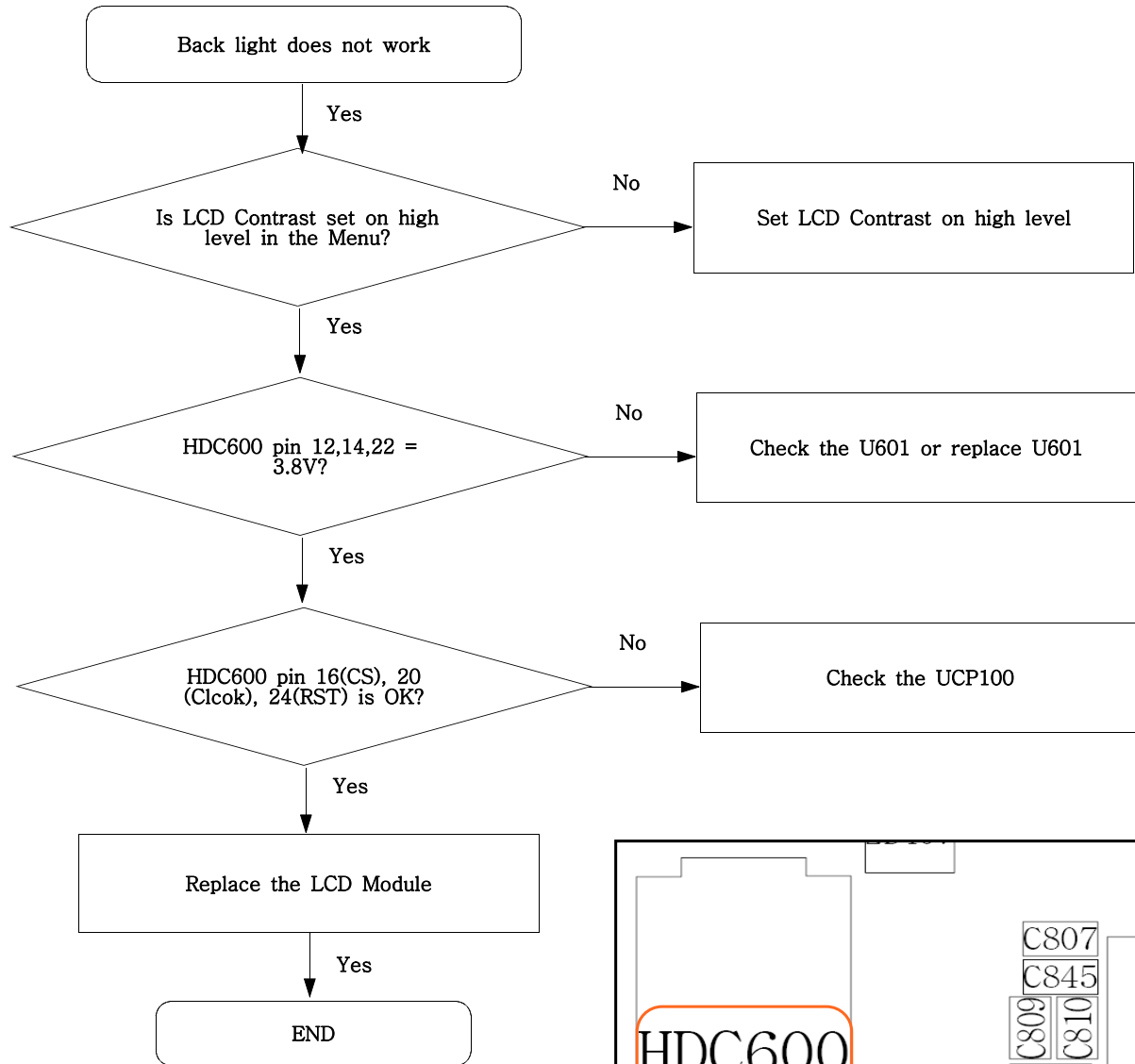

9-10. Key Back Light

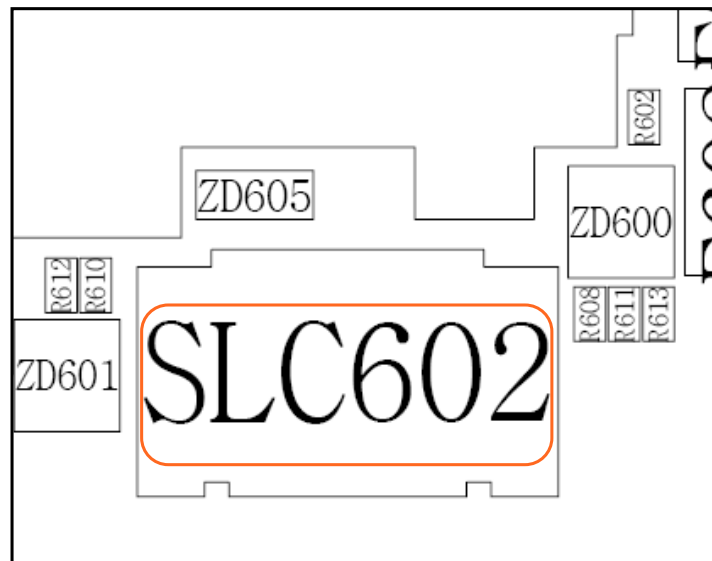
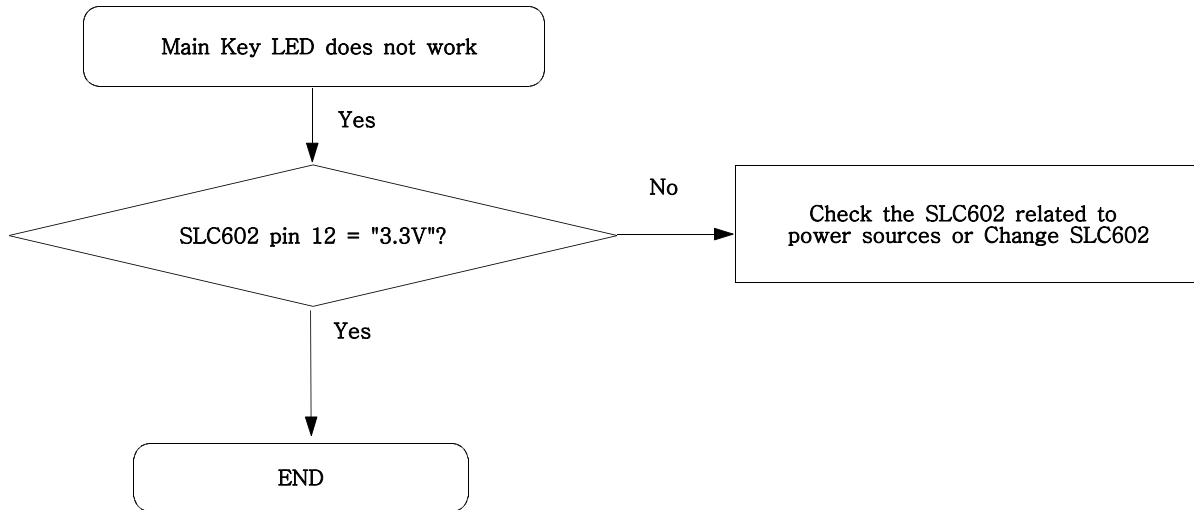

9-11. Camera part

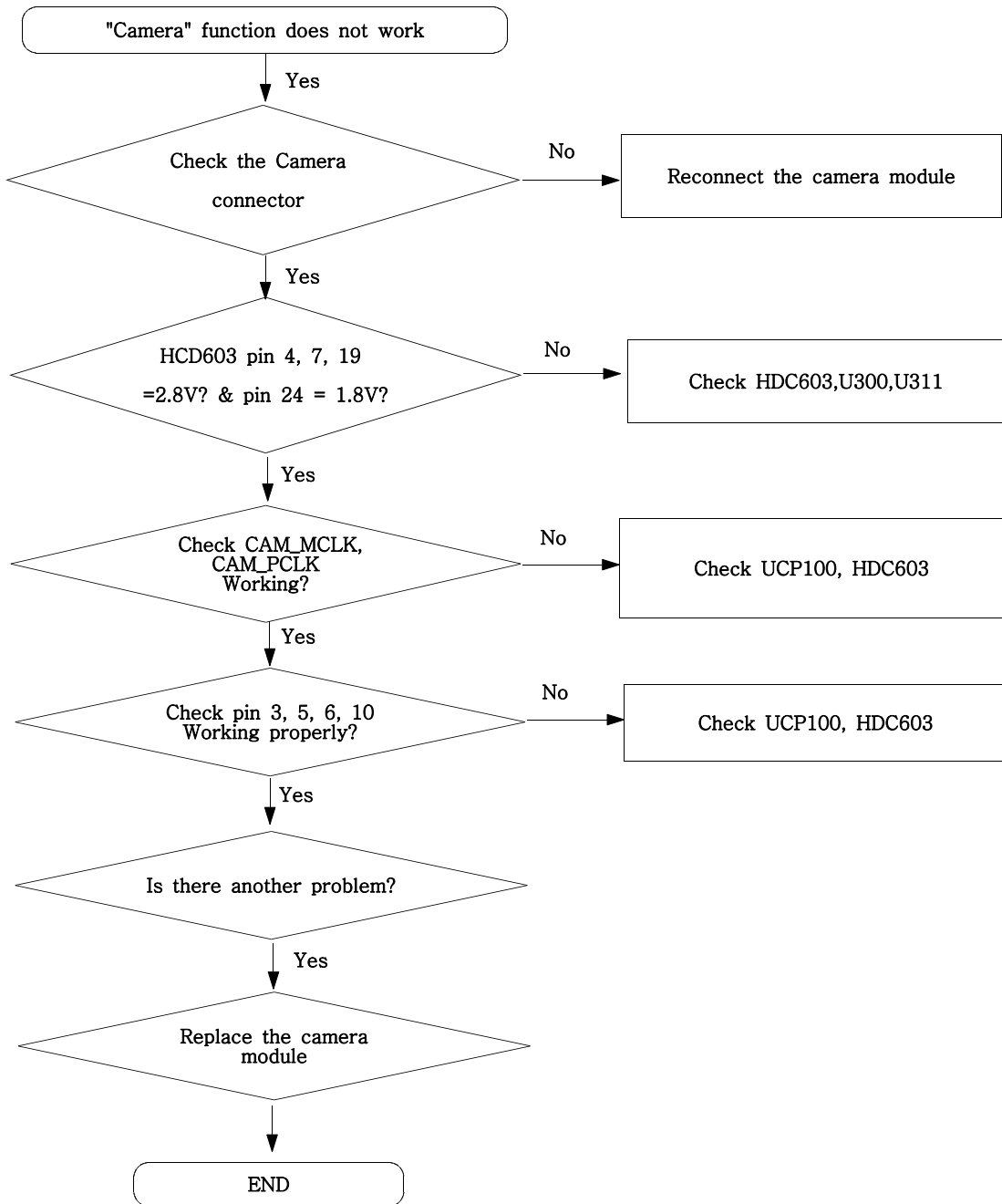

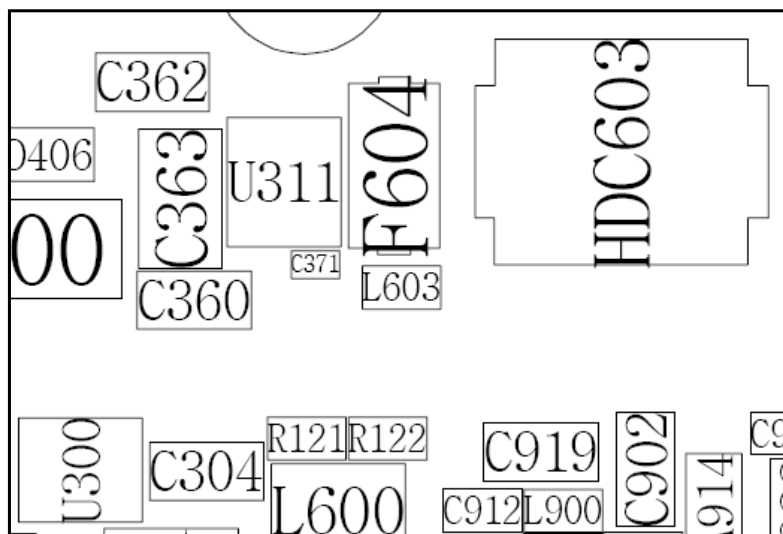
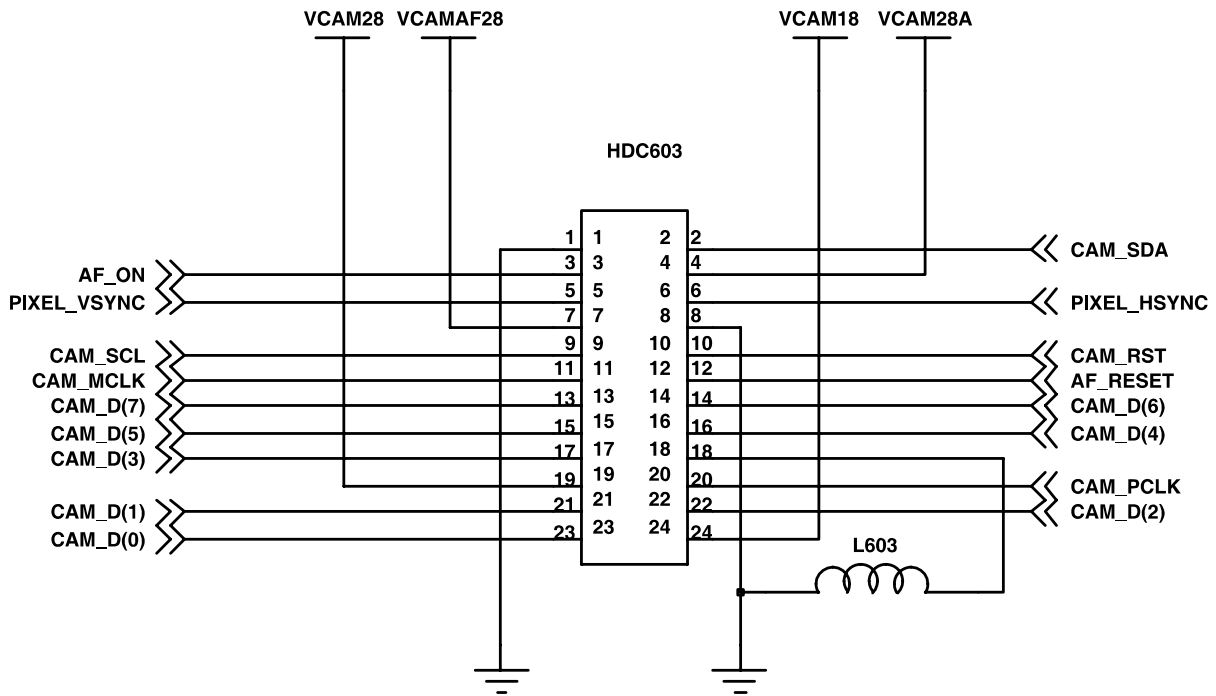

9-12. GSM850 Receiver

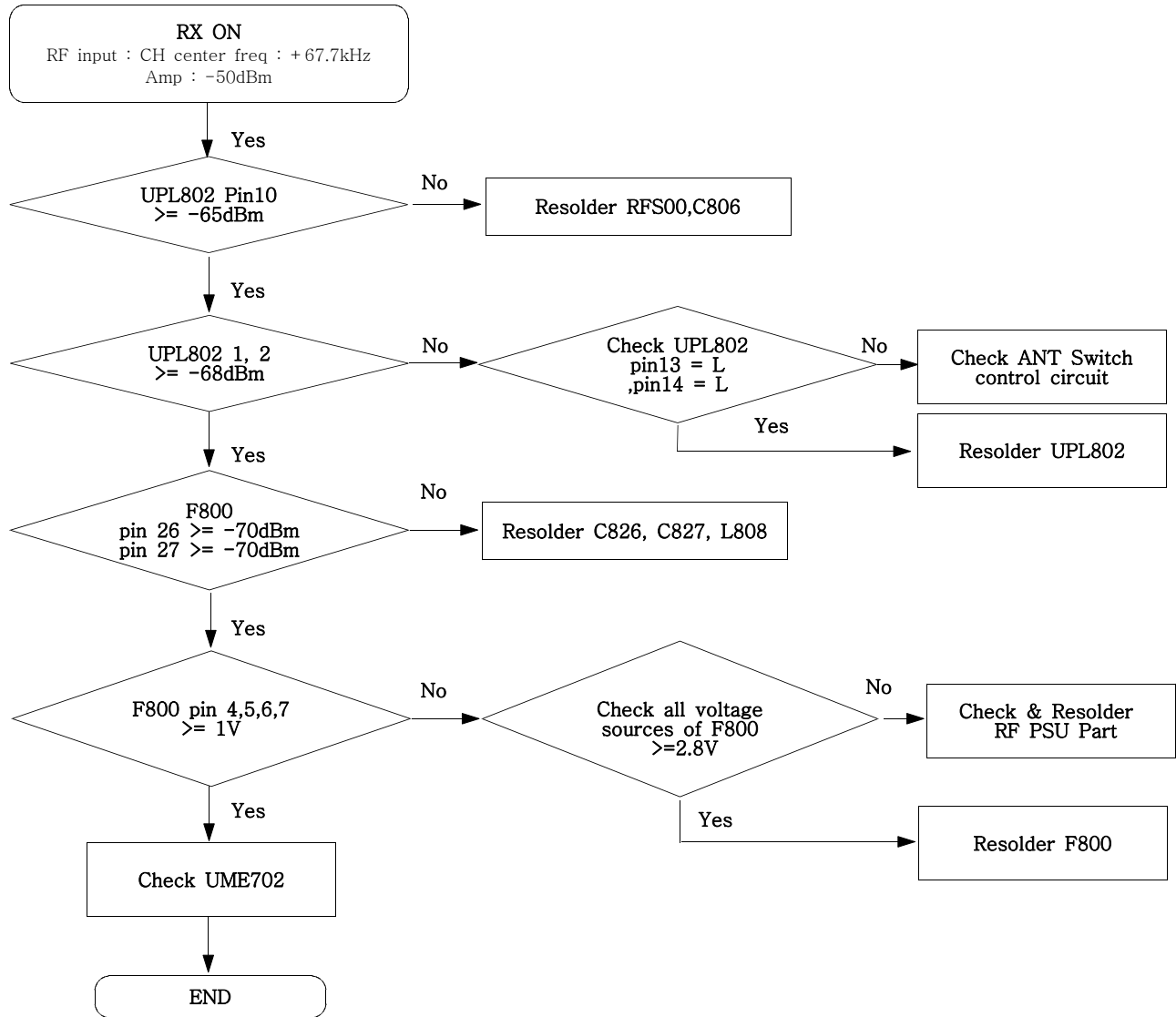

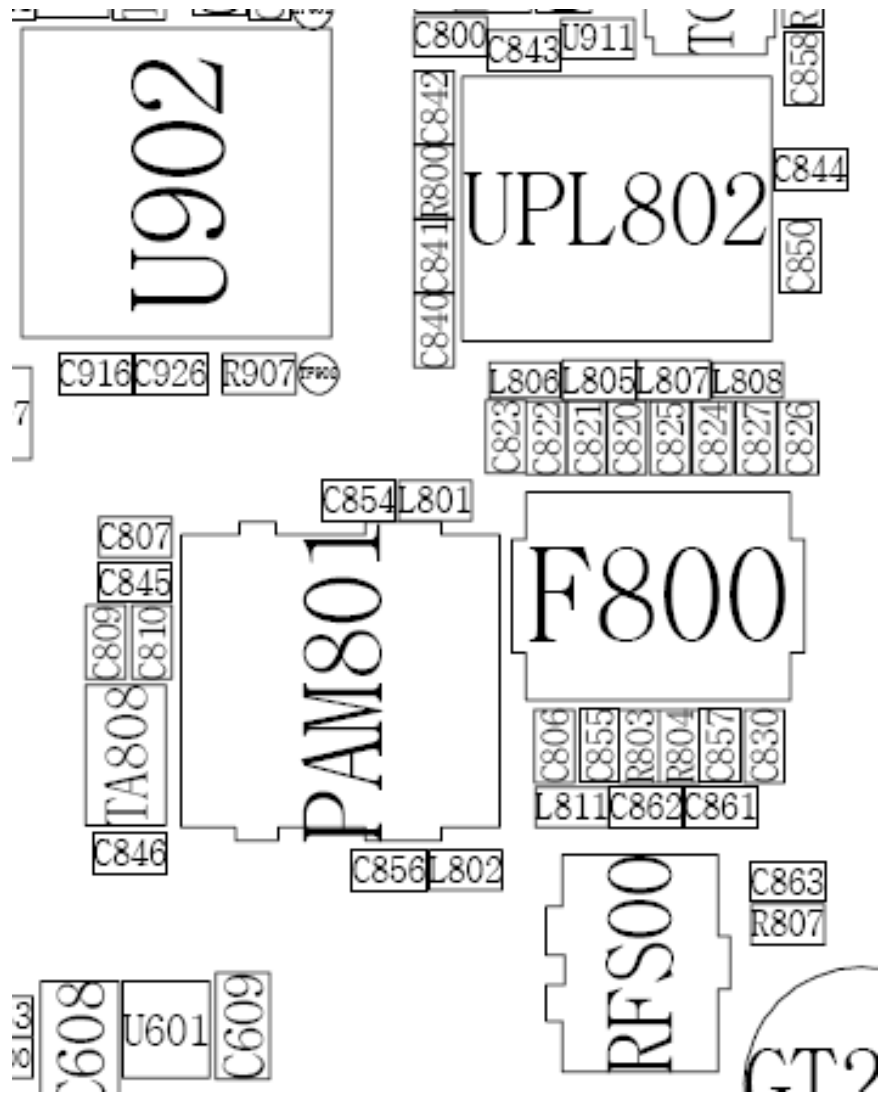

9-13. GSM850 Transmitter

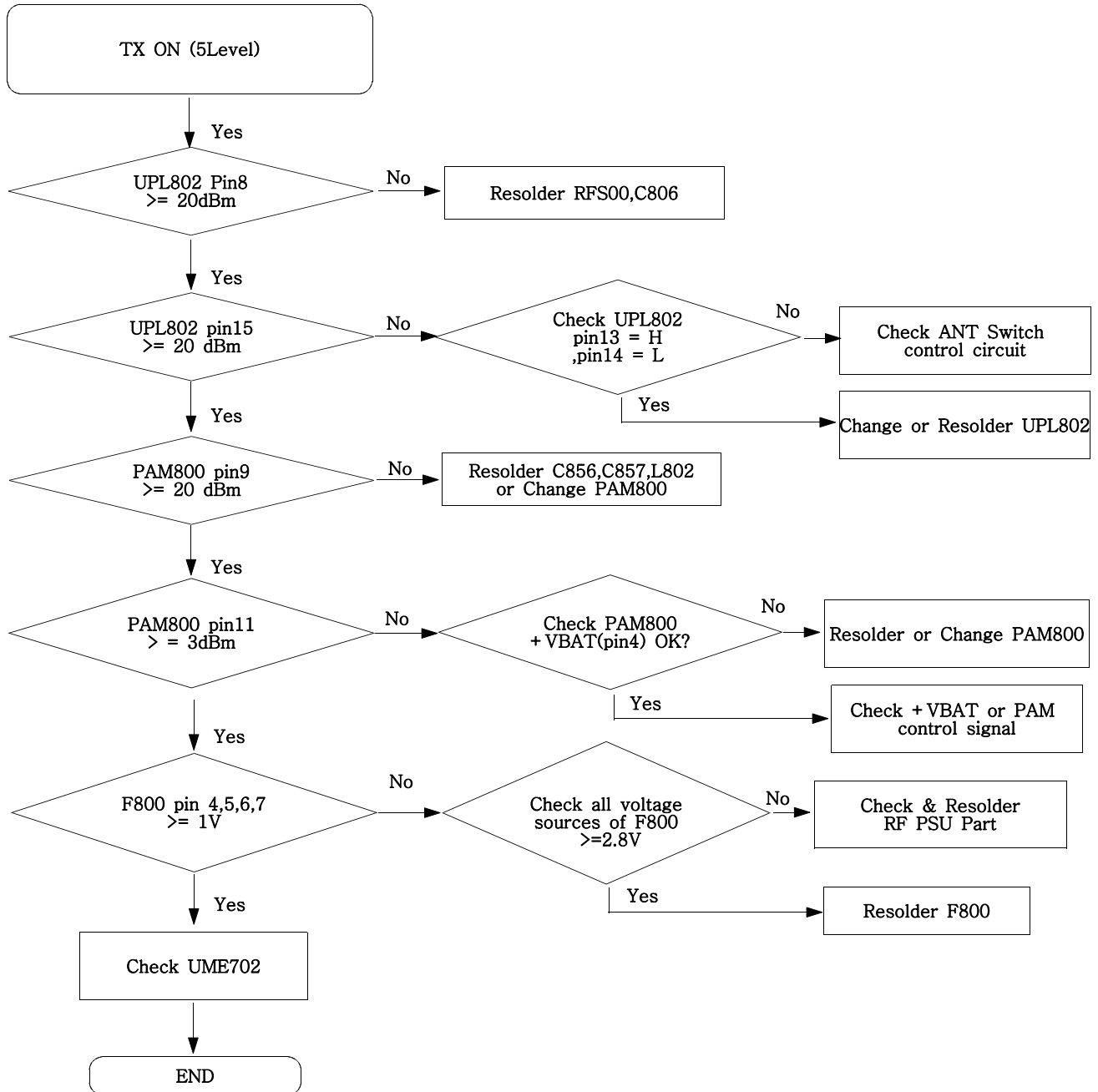

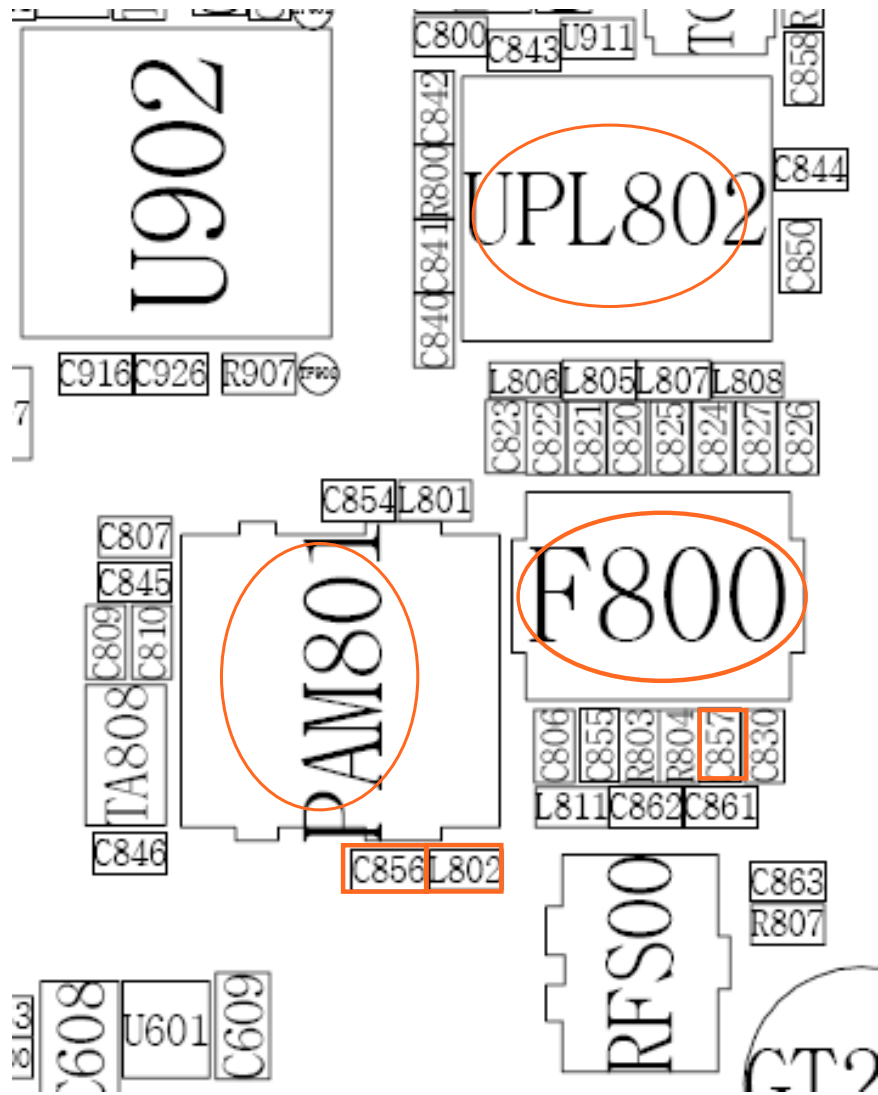

9-14. EGSM900 Receiver

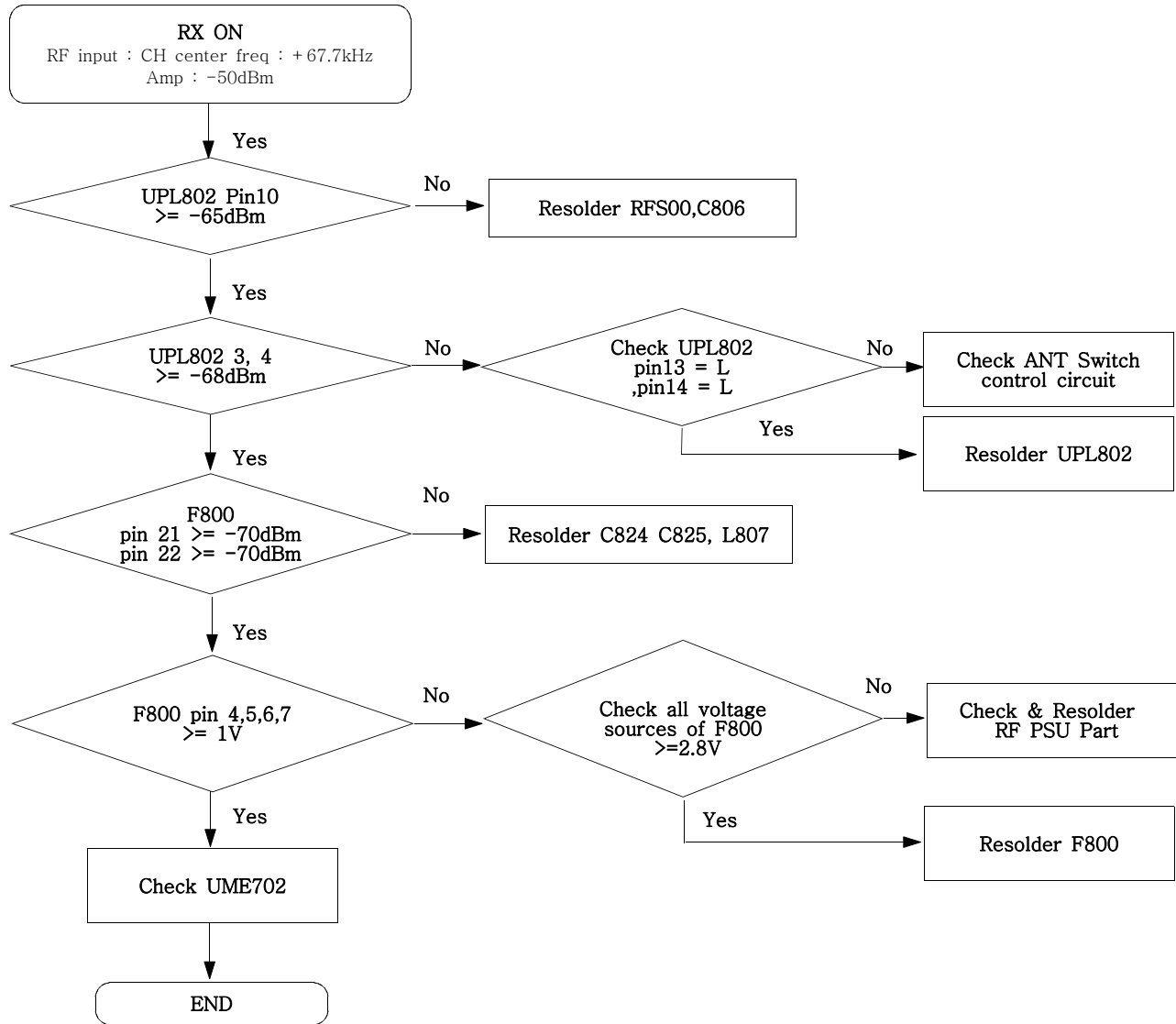

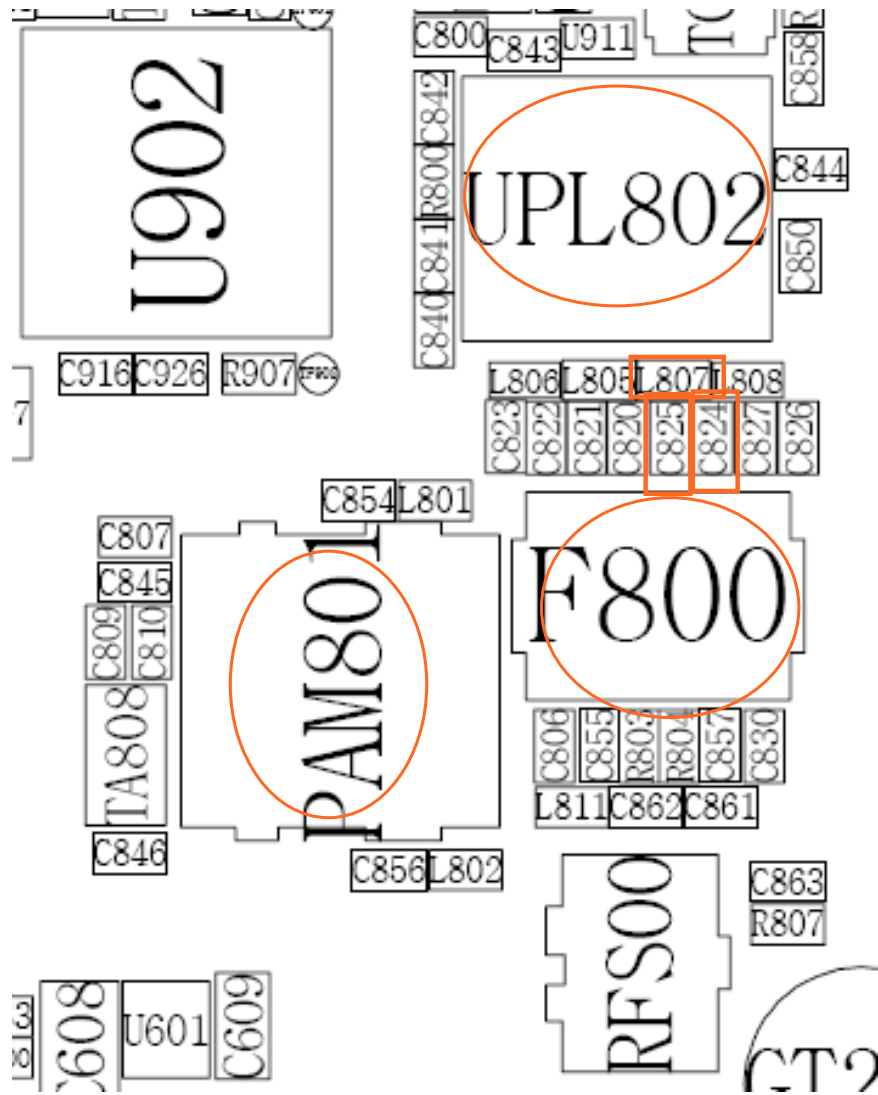

9-15. EGSM900 Transmitter

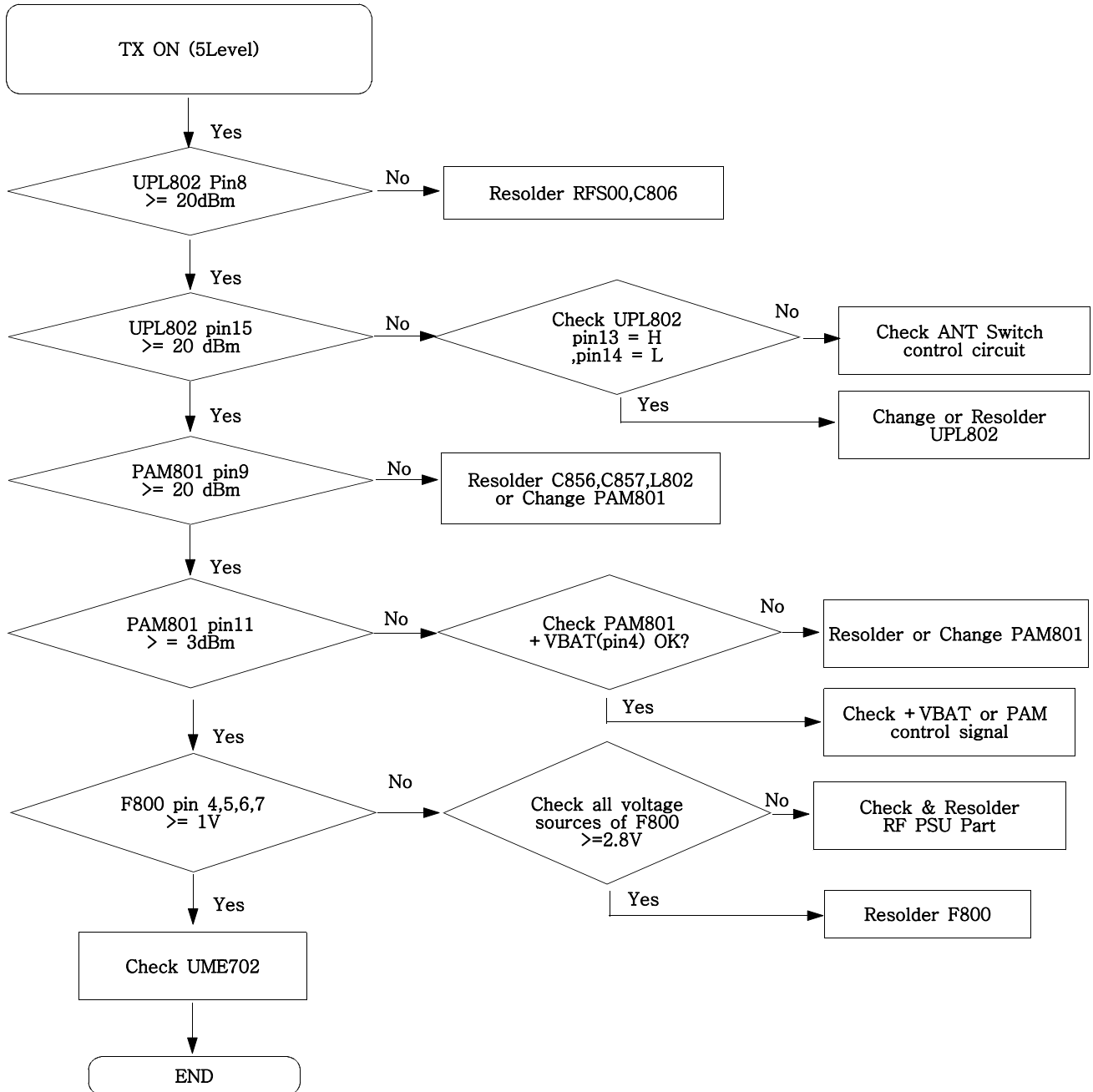

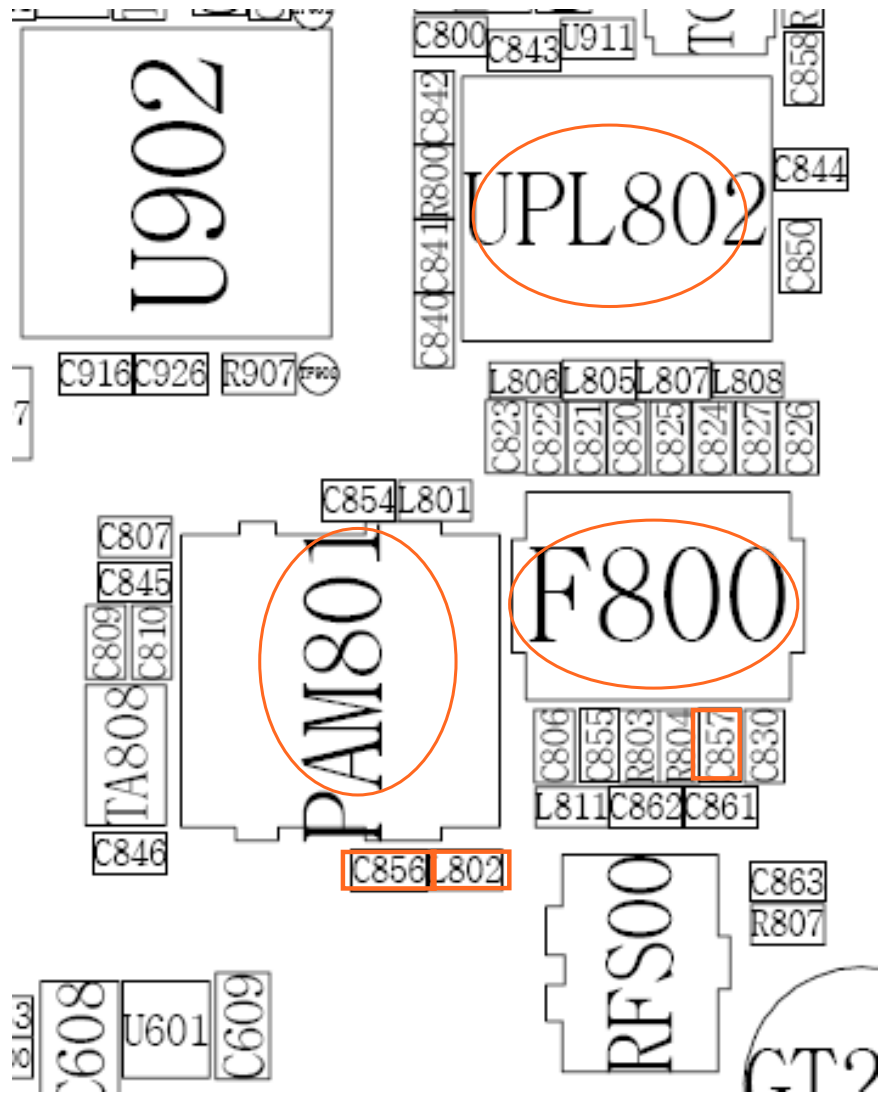

9-16. DCS Receiver

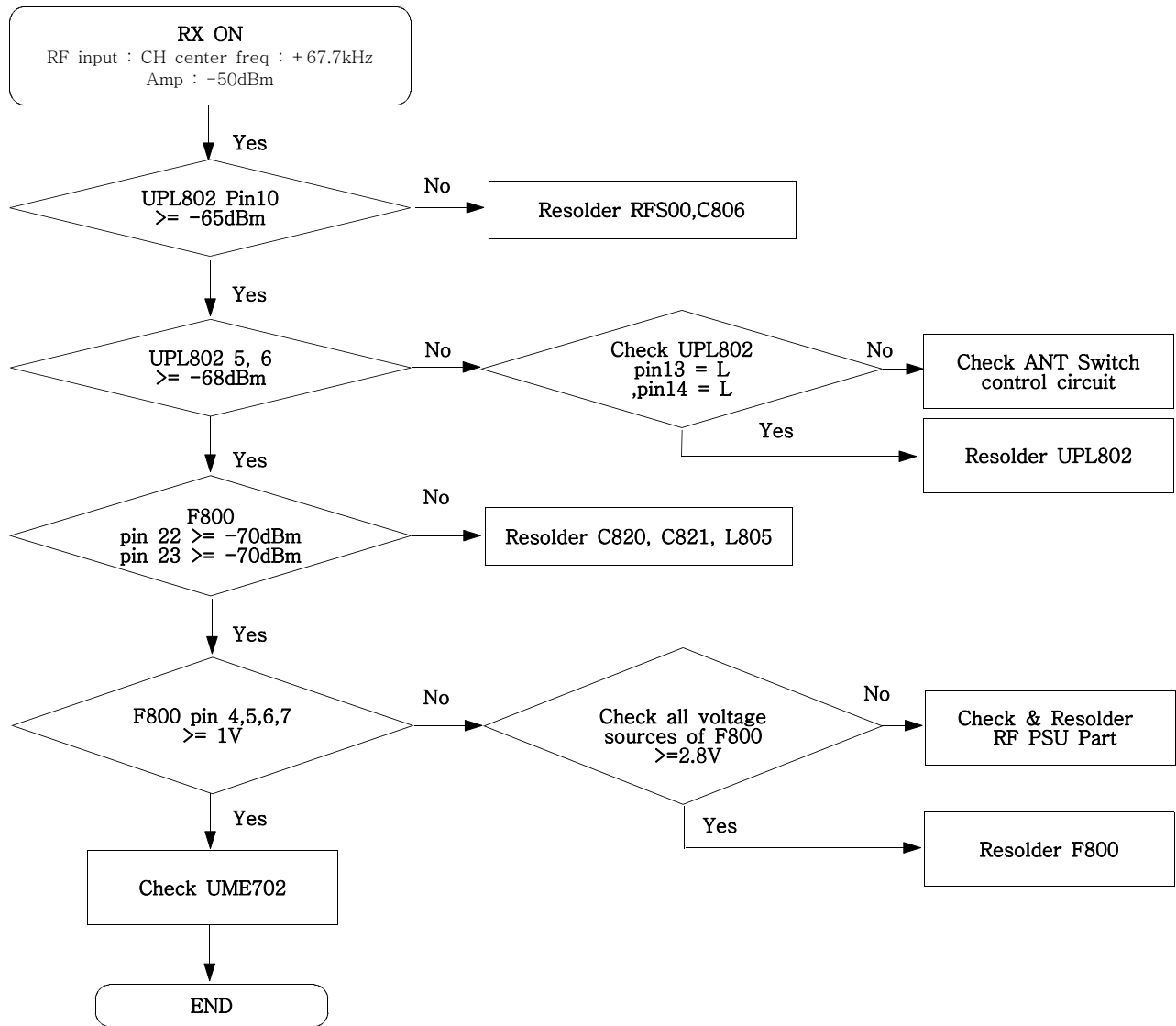

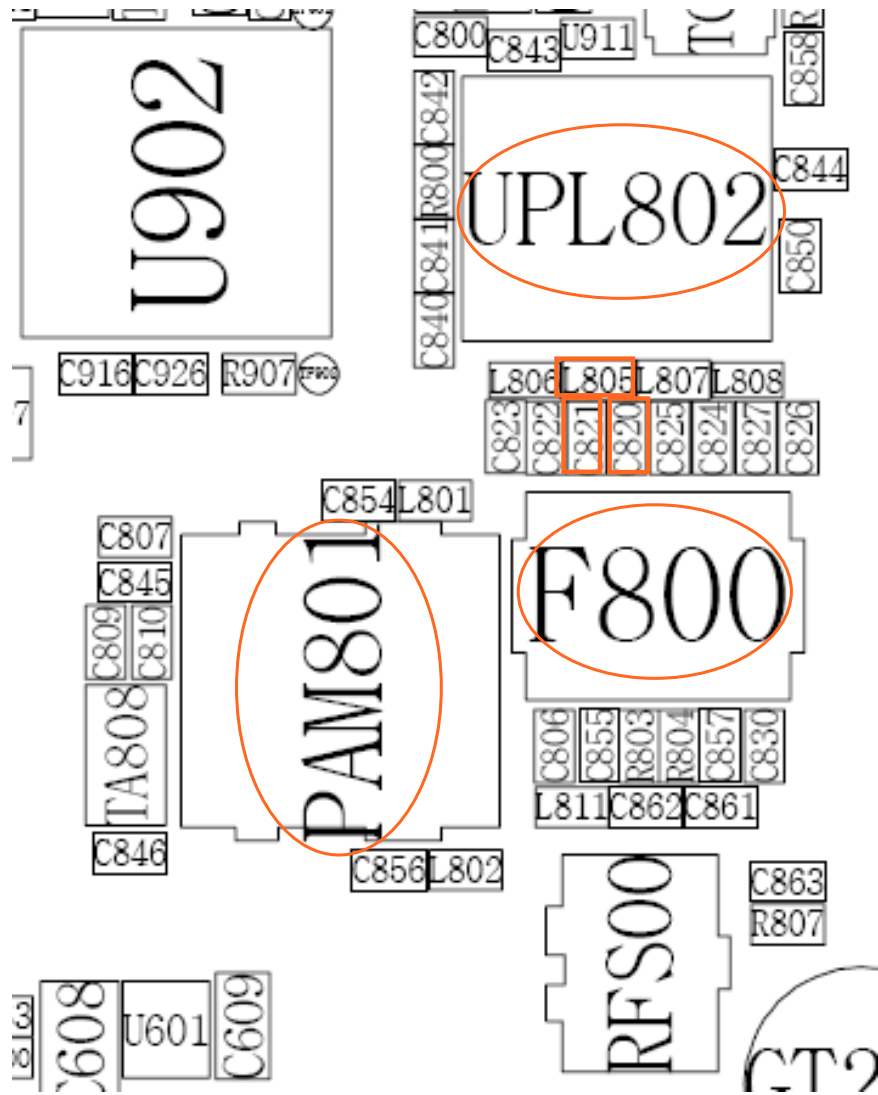

9-17. DCS Transmitter

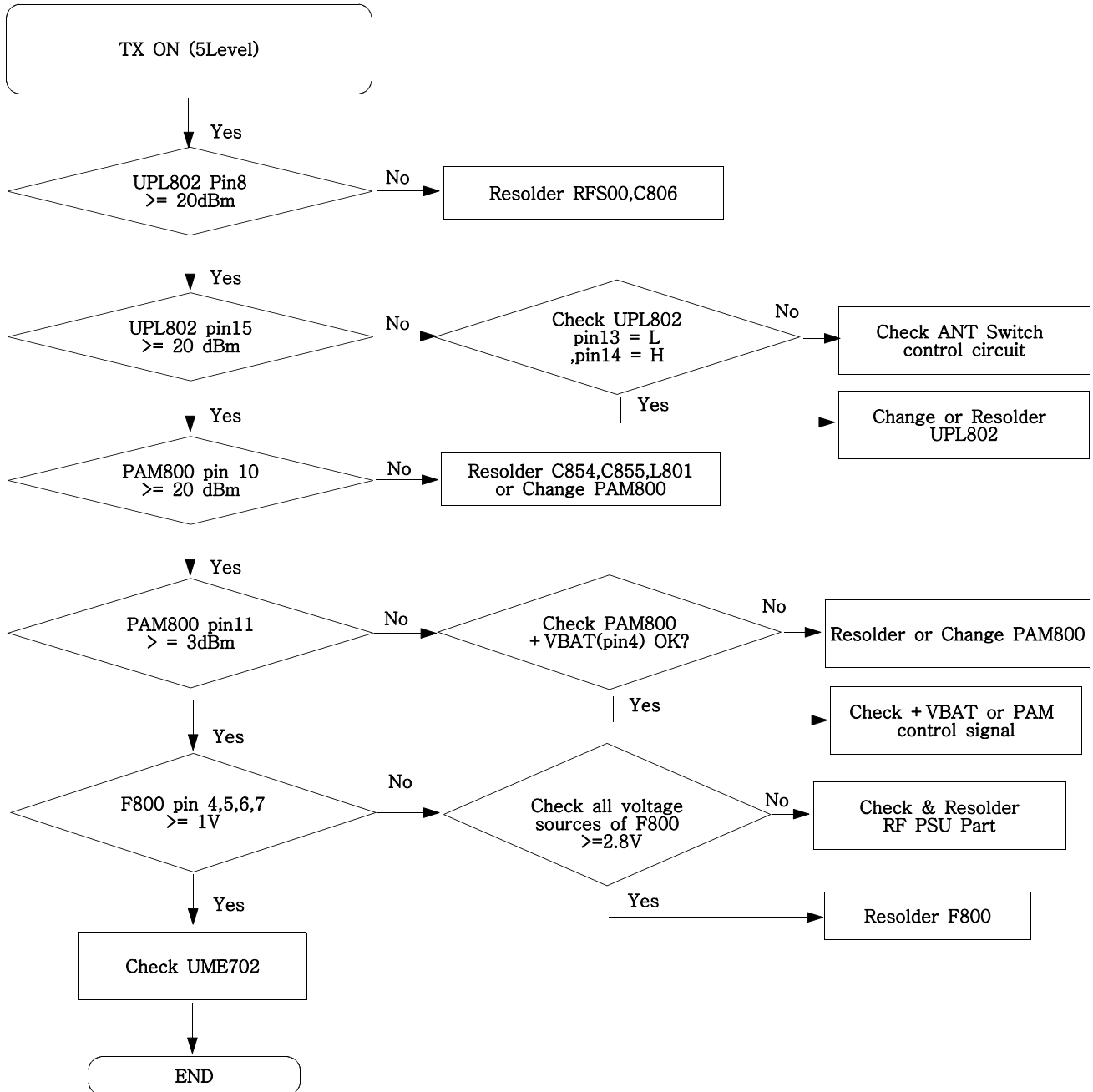

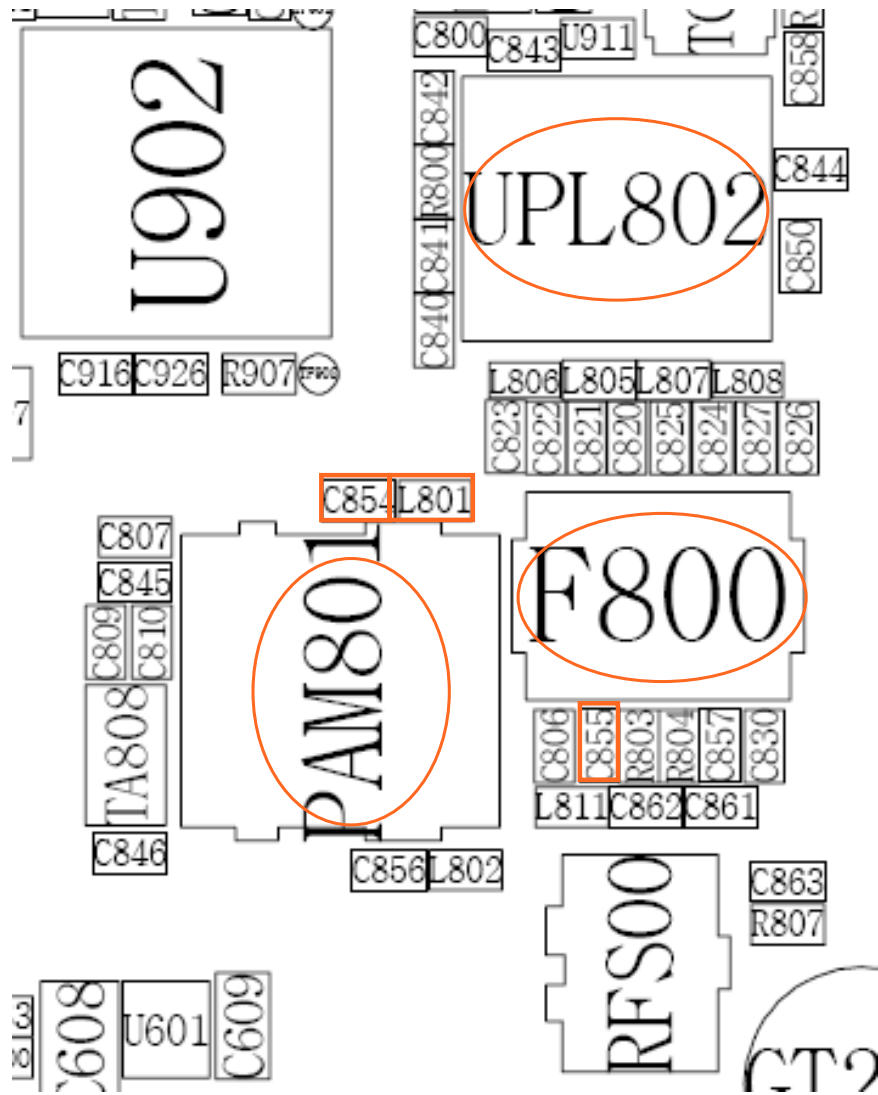

9-18. PCS Receiver

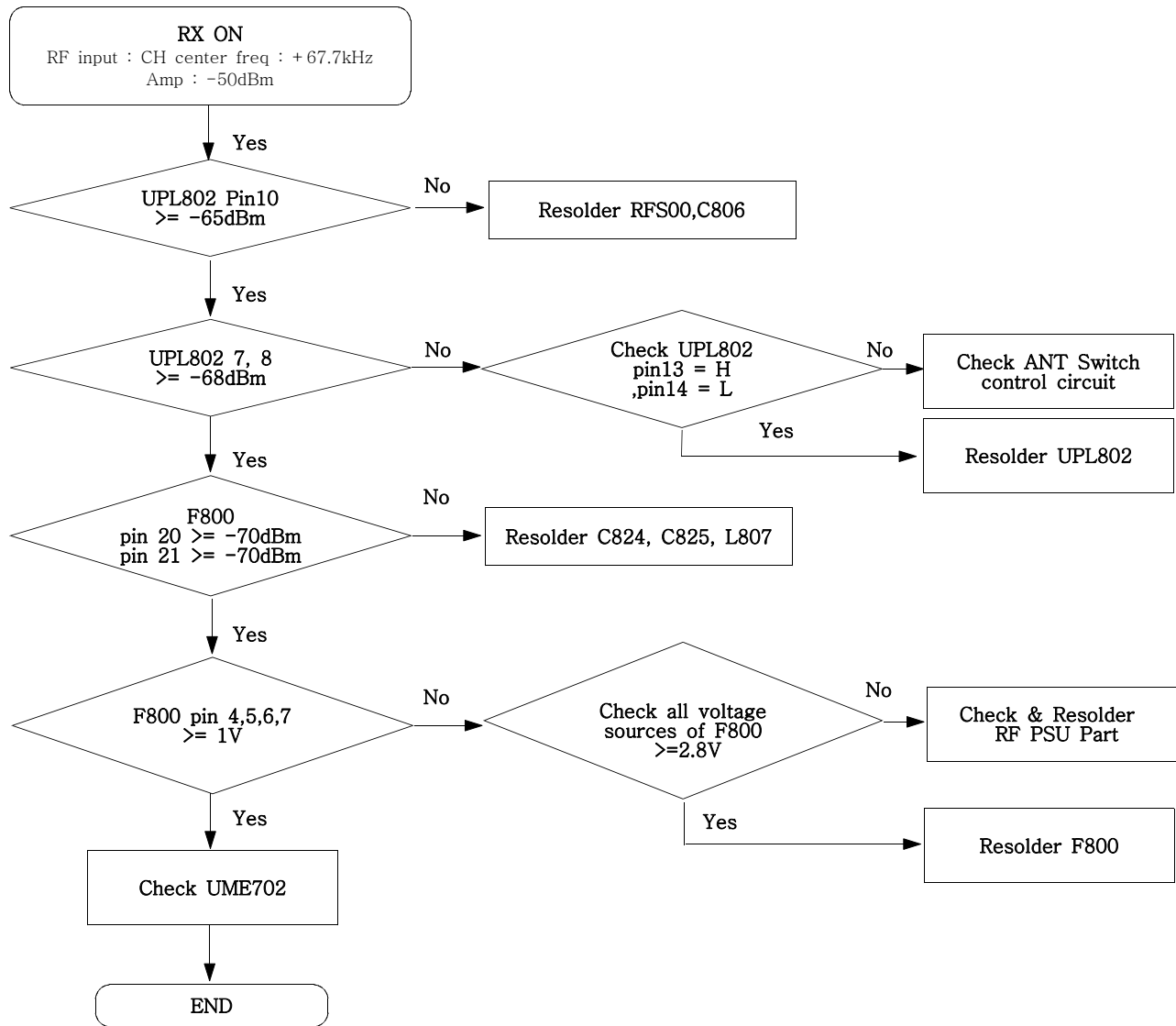

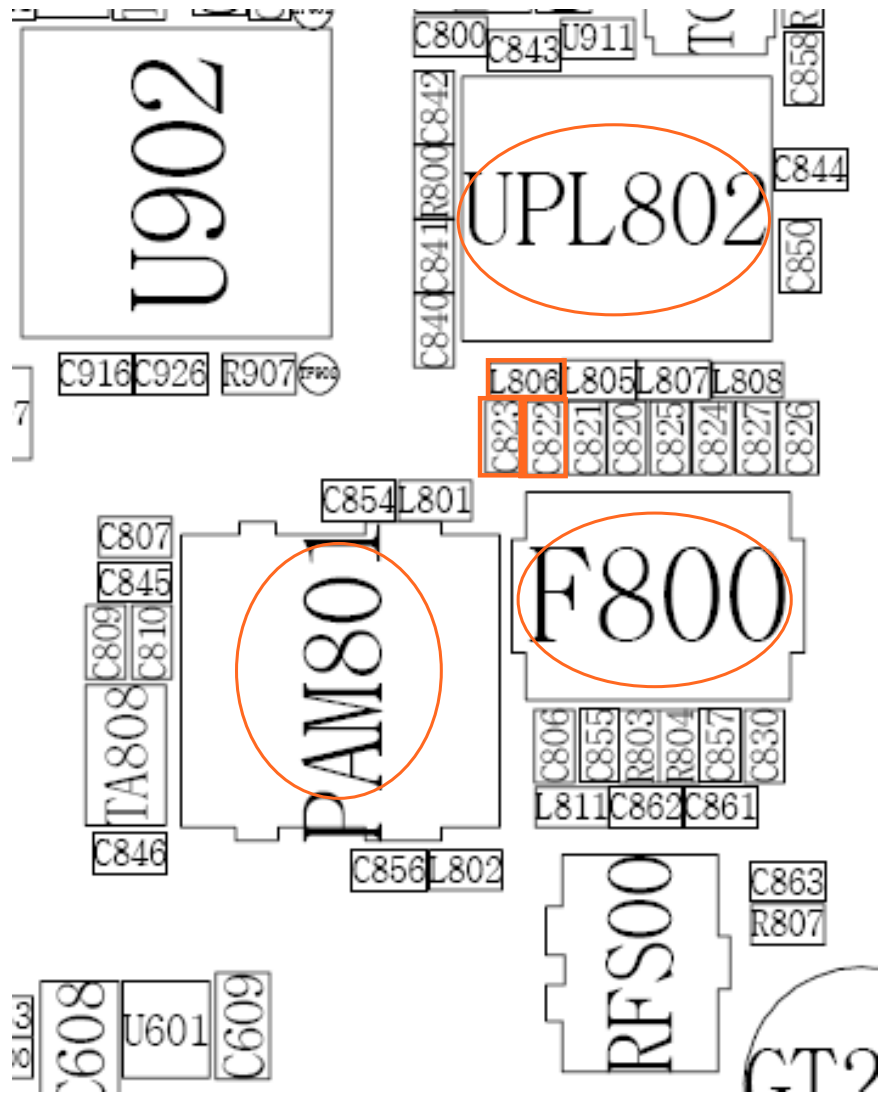

9-19. PCS Transmitter

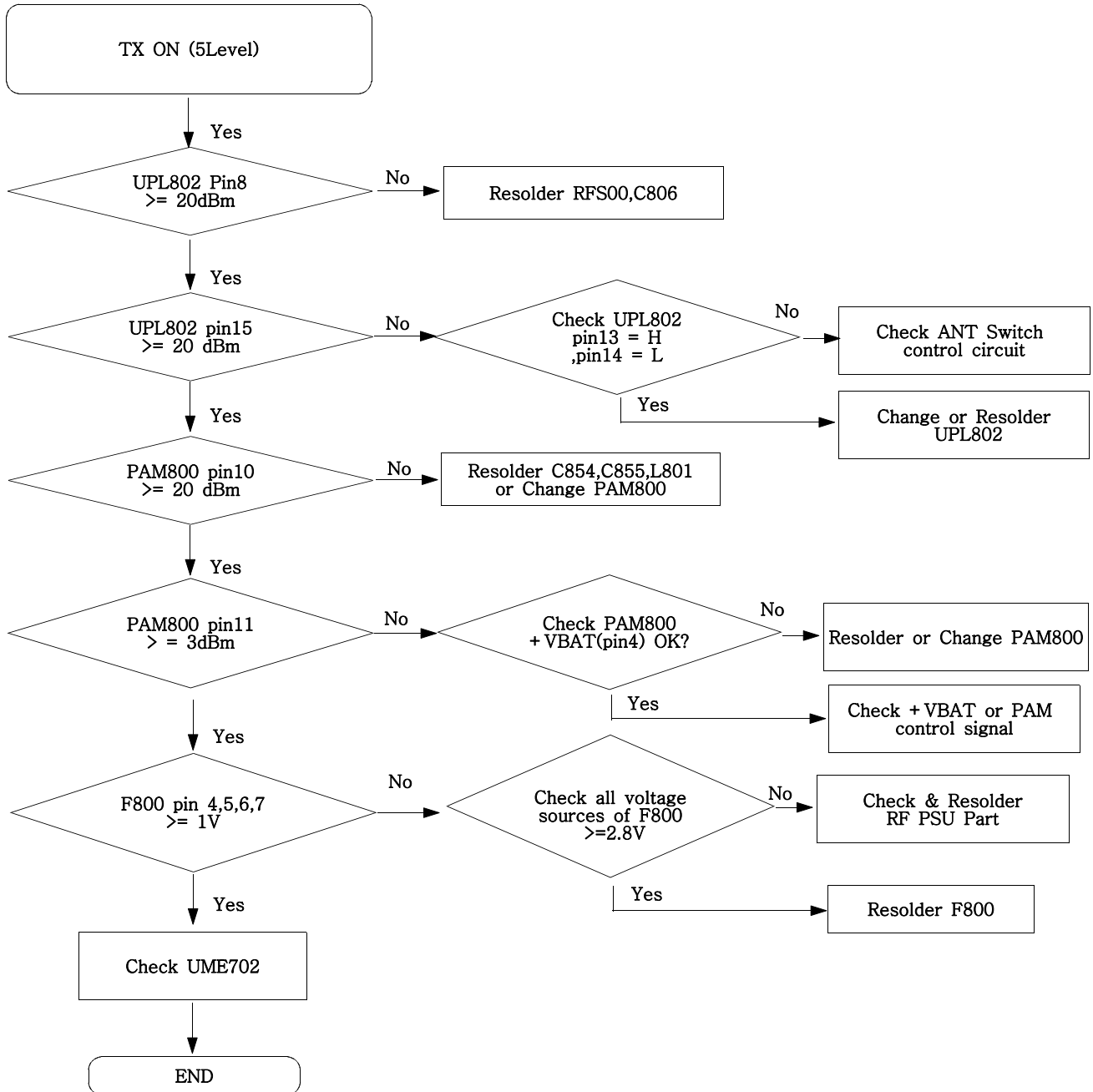

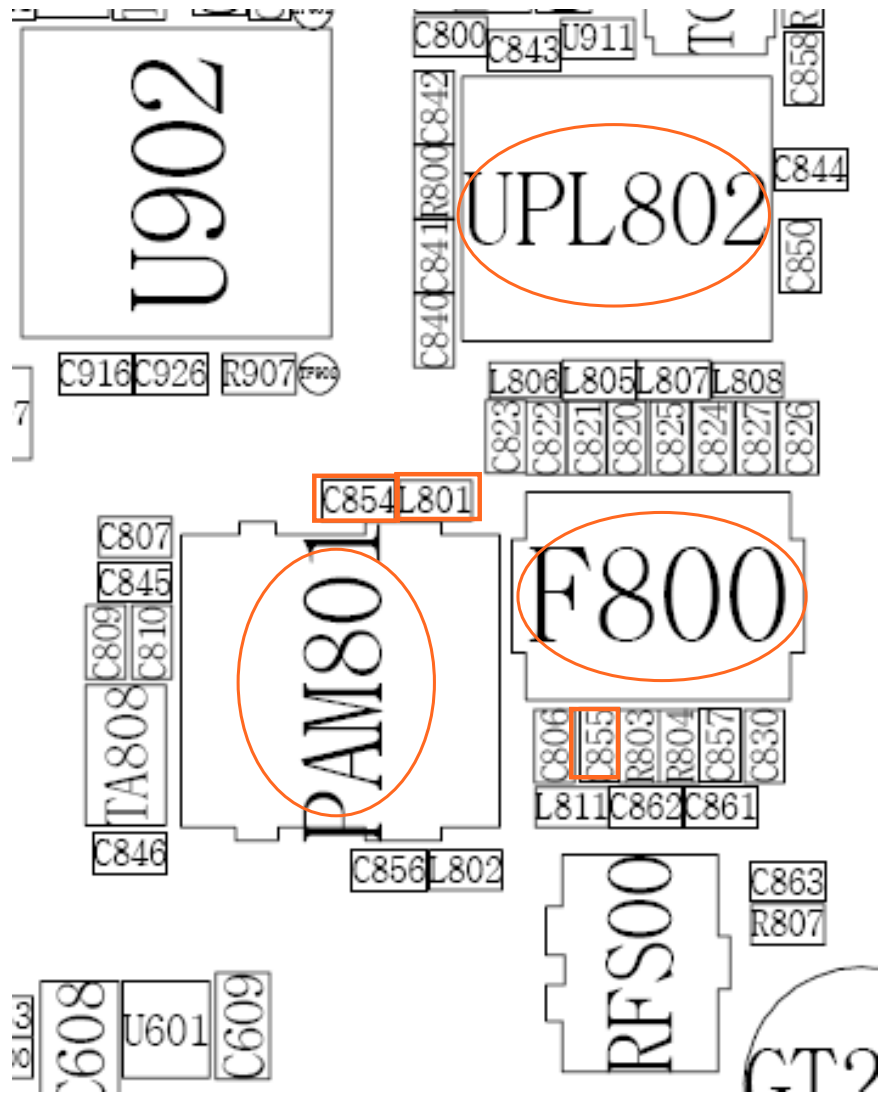

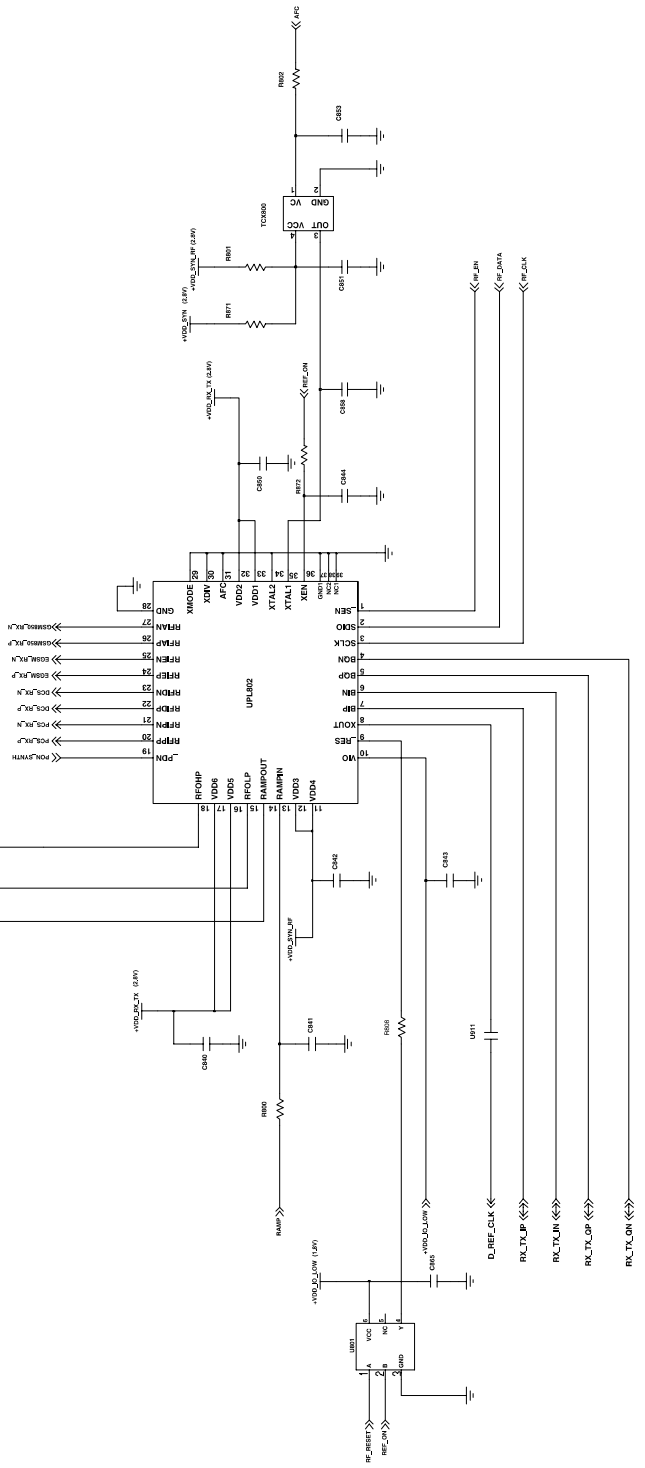
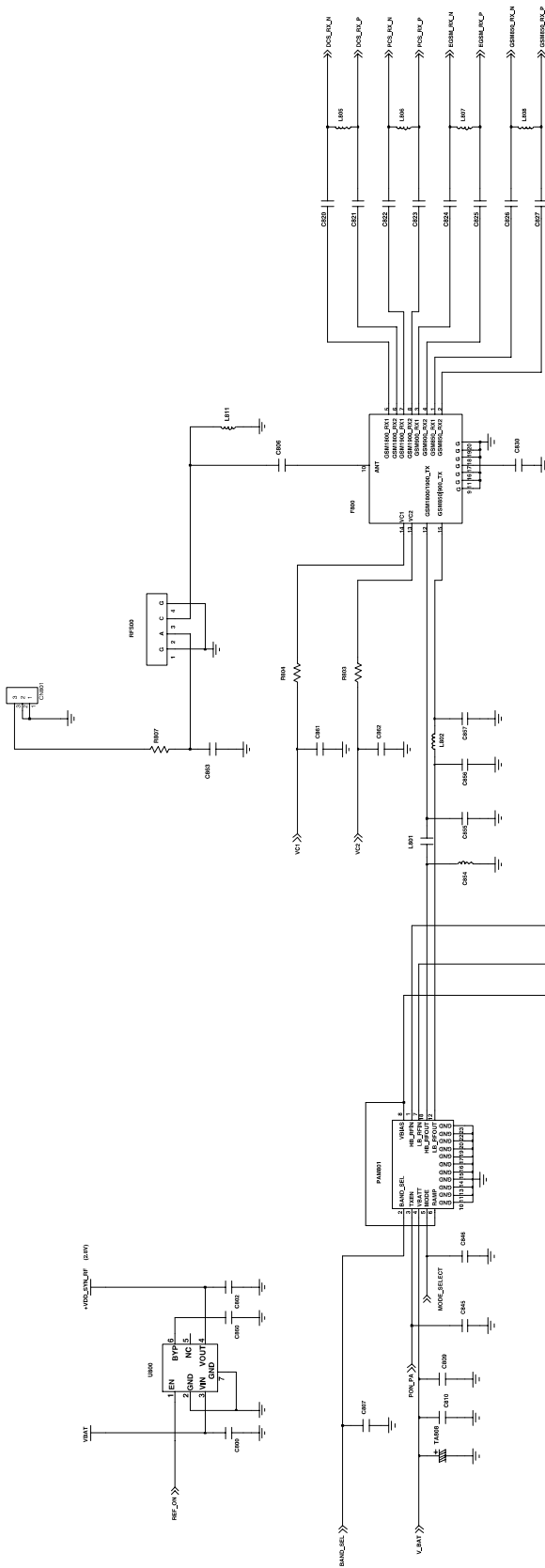

10. Reference data

Reference Abbreviate

- **AAC**: Advanced Audio Coding.
- **AVC** : Advanced Video Coding.
- **BER** : Bit Error Rate
- **BPSK**: Binary Phase Shift Keying
- **CA** : Conditional Access
- **CDM** : Code Division Multiplexing
- **C/I** : Carrier to Interference
- **DMB** : Digital Multimedia Broadcasting
- **EN** : European Standard
- **ES** : Elementary Stream
- **ETSI**: European Telecommunications Standards Institute
- **MPEG**: Moving Picture Experts Group
- **PN** : Pseudo-random Noise
- **PS** : Pilot Symbol
- **QPSK**: Quadrature Phase Shift Keying
- **RS** : Reed-Solomon
- **SI** : Service Information
- **TDM** : Time Division Multiplexing
- **TS** : Transport Stream

