

CN801

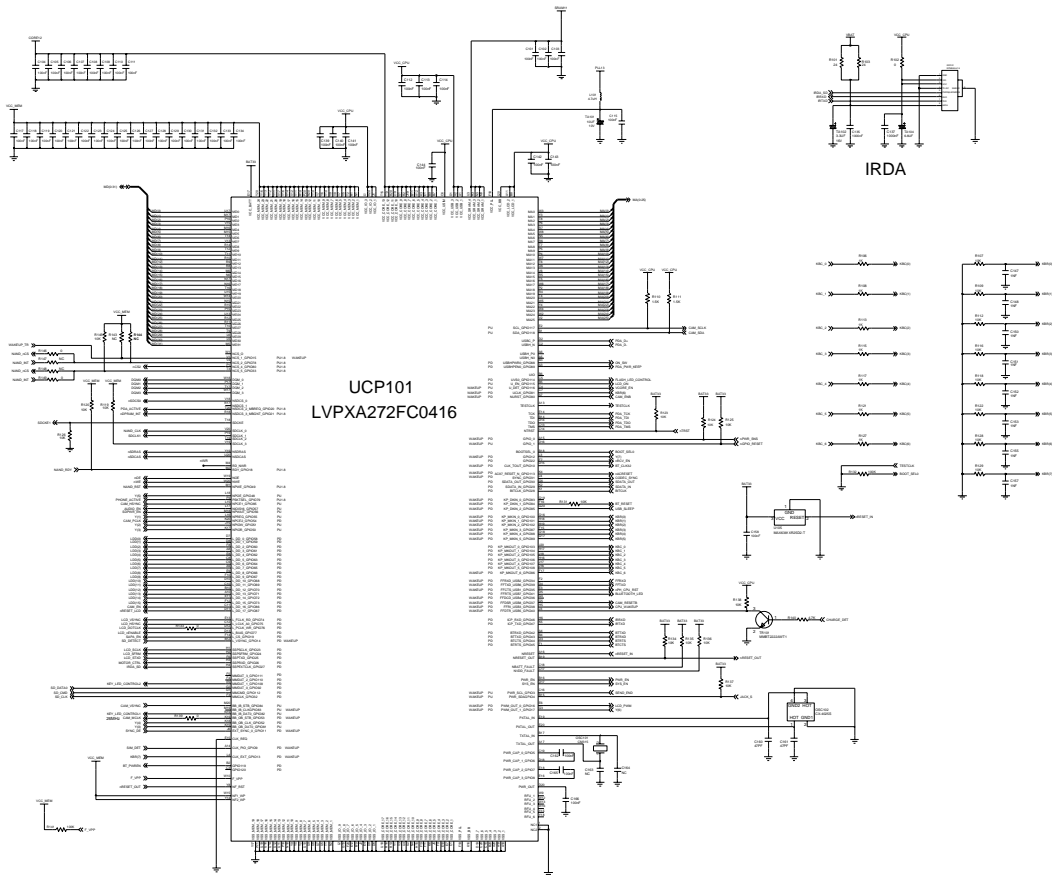

UCP101
LVPXA272FC0416

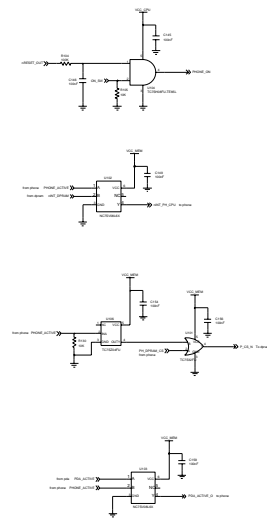
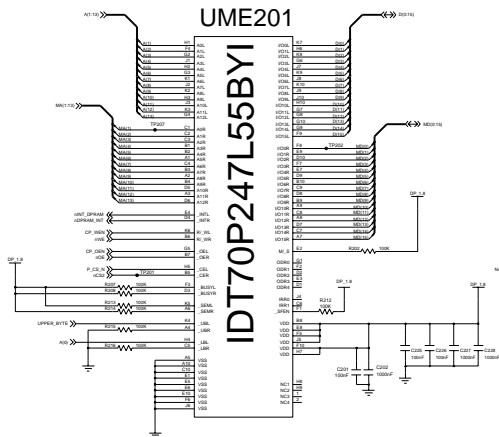
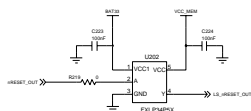
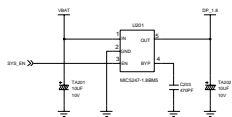

1.8V-1.8V DPRAM

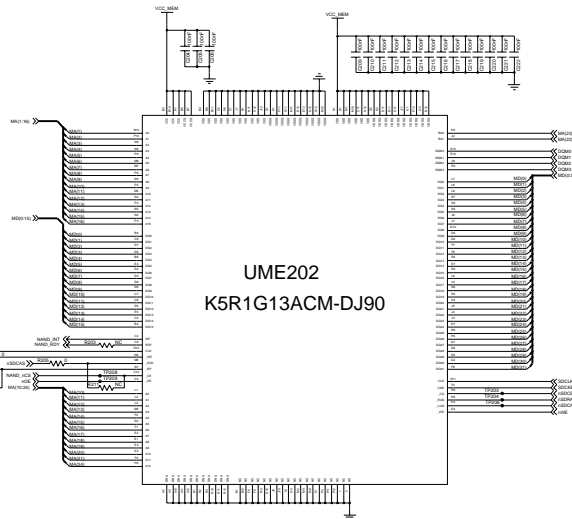

64MB SDRAM + 128MB ONENAND

| MEMORY | |
|--------|---------|
| TYPE | SDRAM |
| SIZE | 64MB |
| TYPE | ONENAND |
| SIZE | 128MB |
| MEMORY | |
| MEMORY | MEMORY |

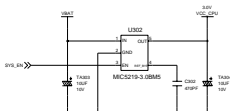

VCC_CPU

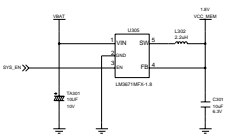

VCC_MEMORY

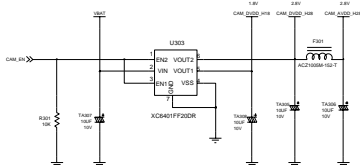

CAMERA VOLTAGE

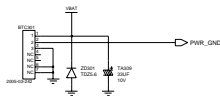

BATTERY CONNECTOR

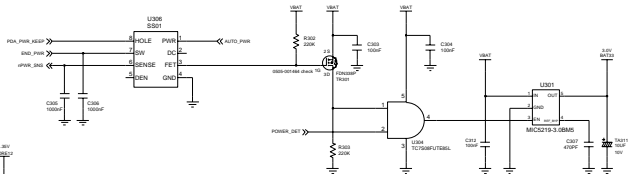

PDA POWER

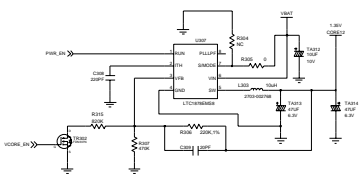

CORE_PLL

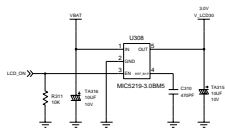
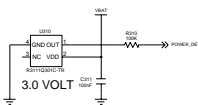

LCD_VOLTAGE

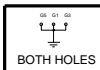

BOTH HOLES

| POWER | |
|-------|---------|
| POWER | 0.00000 |
| POWER | 0.00000 |
| POWER | 0.00000 |
| POWER | 0.00000 |
| POWER | 0.00000 |

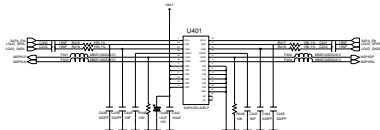
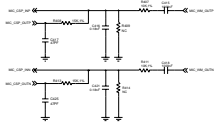
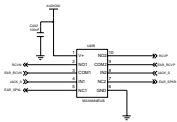

AUDIO AMP (SAPA QFN)

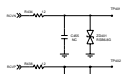

RECEIVER

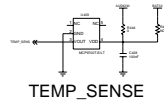
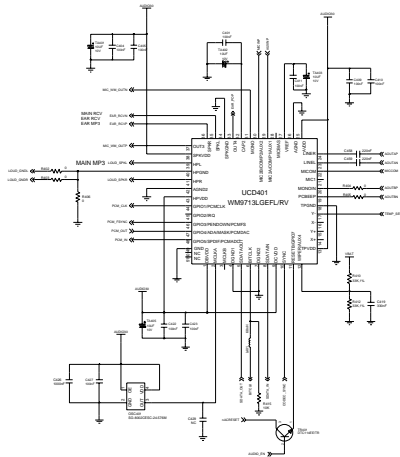

TEMP_SENSE

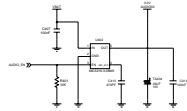

AUDIO30

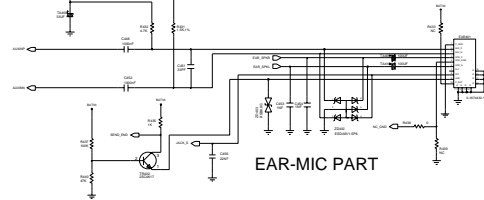
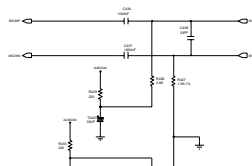
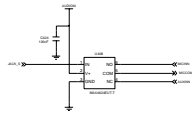

EAR-MIC PART

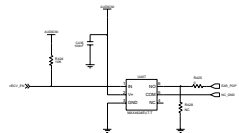

| AUDIO | |
|-------|--|
| | |
| | |
| | |
| | |
| | |

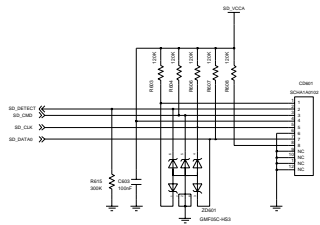

T-FLASH

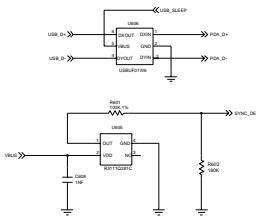

USB 1.1

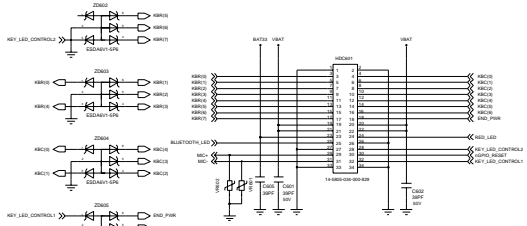

KEY CONNECTOR

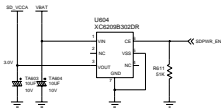

T-FLASH VOLTAGE

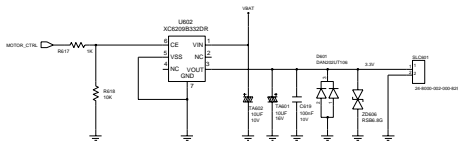

3.3V REGULATOR

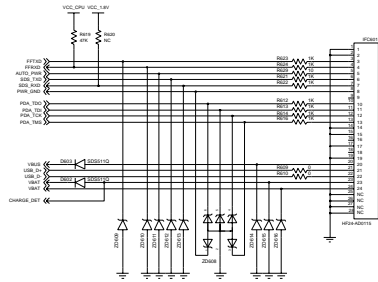
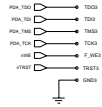

IF CON(F24 CUTTING TYPE)

| | | |
|--------------|----------|--------------------------------------|
| PROJECT | 03-03-03 | HDA & USB & VIBRATOR & F_FLASH & KEY |
| DESIGNER | 03-03-03 | |
| REVISION | 03-03-03 | |
| DATE CHECKED | | |
| DATE | | |

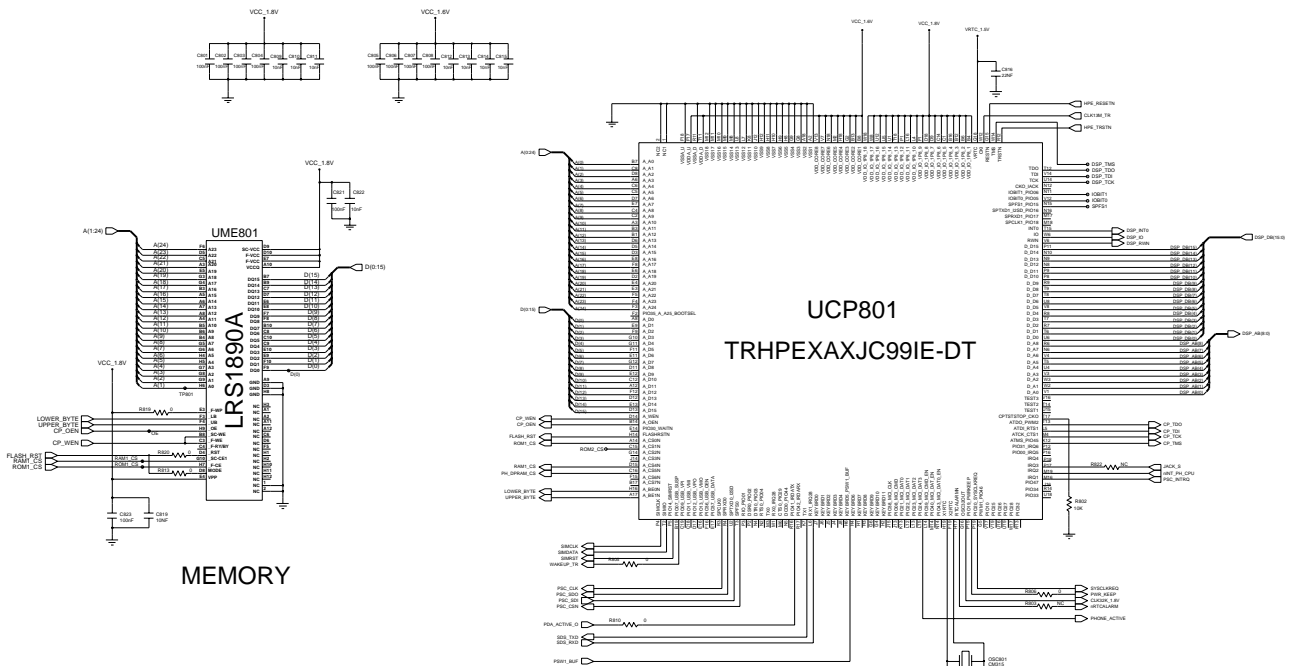

MEMORY

UCP801
TRHPEXAXJC99IE-DT

HPE

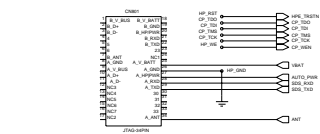

SMD DEBUG

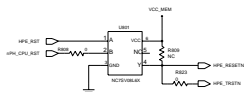

HPE RESET

| HPE & MEMORY | |
|--------------|------------|
| UCP801 | UCP801 |
| UME801 | UME801 |
| LRS180A | LRS180A |
| Z86800 | Z86800 |
| RESISTORS | RESISTORS |
| CAPACITORS | CAPACITORS |
| DIODES | DIODES |
| INDUCTORS | INDUCTORS |
| CONNECTORS | CONNECTORS |
| OTHER | OTHER |

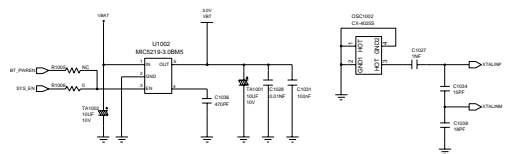
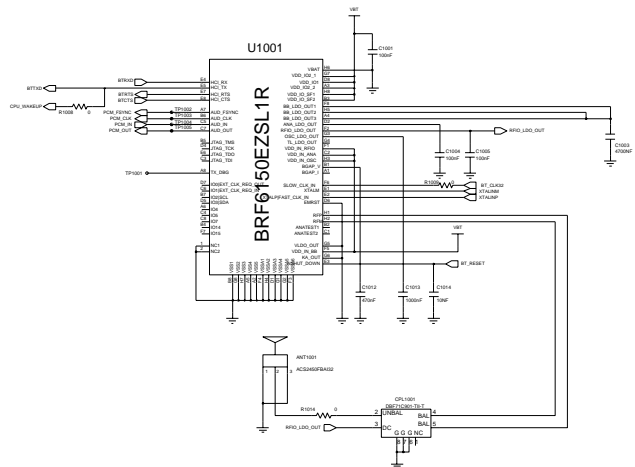

Bluetooth

| | |
|---------|-----------|
| Project | BT & WLAN |
| Version | 1.0 |
| Author | ... |
| Date | ... |
| Sheet | 12 |