

U101
LVPXA272FC0416

IRDA

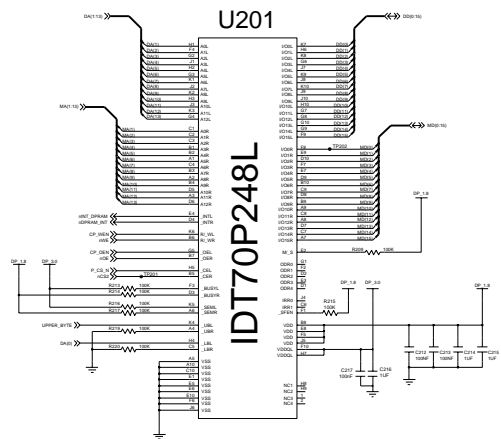

1.8V-3V DPRAM

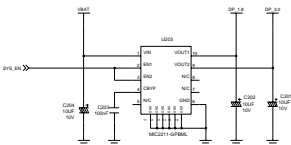
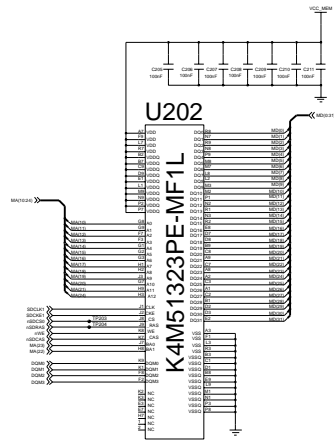

SDRAM 64MB*8
(512Mb)

Part No.	Q-1000	MEMORY
Quantity	100000	
Manufacturer	SGS-THOMSON	SGH-1300
Part Name	SGH-1300	
Part No.	Q-1000	Sheet 2

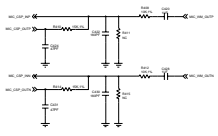
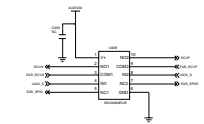

AUDIO AMP (SAPA 1D2)

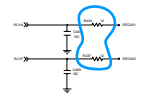

RECEIVER

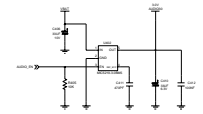
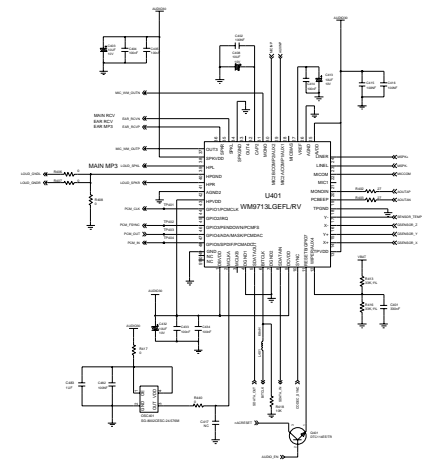

AUDIO30

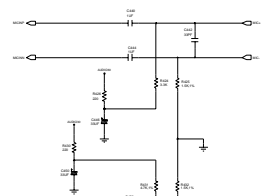
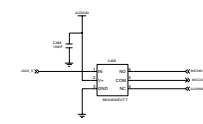

EAR-MIC PART

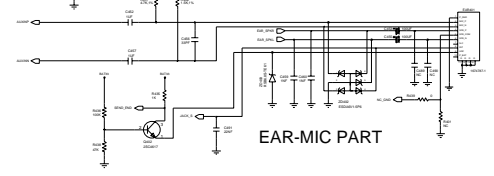
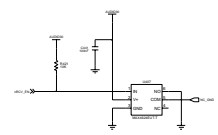

AUDIO	
SGH-1300	
SGH-1300	
SGH-1300	

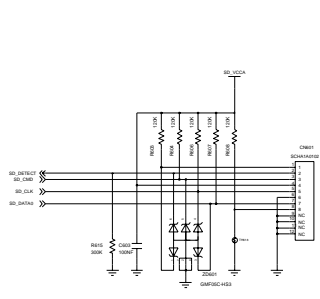

T-FLASH

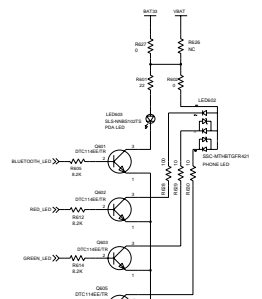

STATUS LED

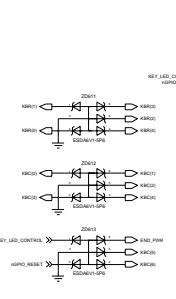

KEY CONNECTOR

MP3 - KBC(0) & KBR(3)
 RECORD - KBC(6) & KBR(2)
 QUICK - KBC(1) & KBR(3)
 HOLD - KBC(3) & KBR(3)

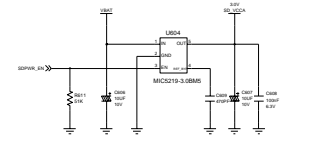

T-FLASH VOLTAGE

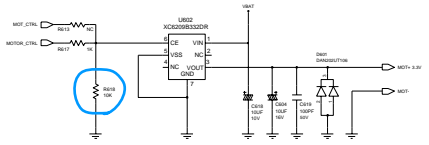

3.3V REGULATOR

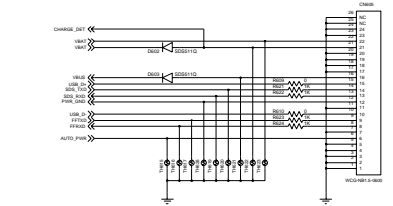

IF CON(Forward type)

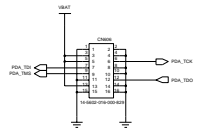

JTAG FOT Bootloader

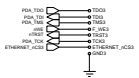

Model	SGH-1300	ICs	ICs & USB & VIBRATOR & IF_CON & KEY
Version	3.0.0.0	Total	
Manufacturer	SGS-THOMSON	Part No.	SGH-1300
Doc No.	SGH-1300-01	Rev	01
Doc Date	2002.02	Sheet No.	12

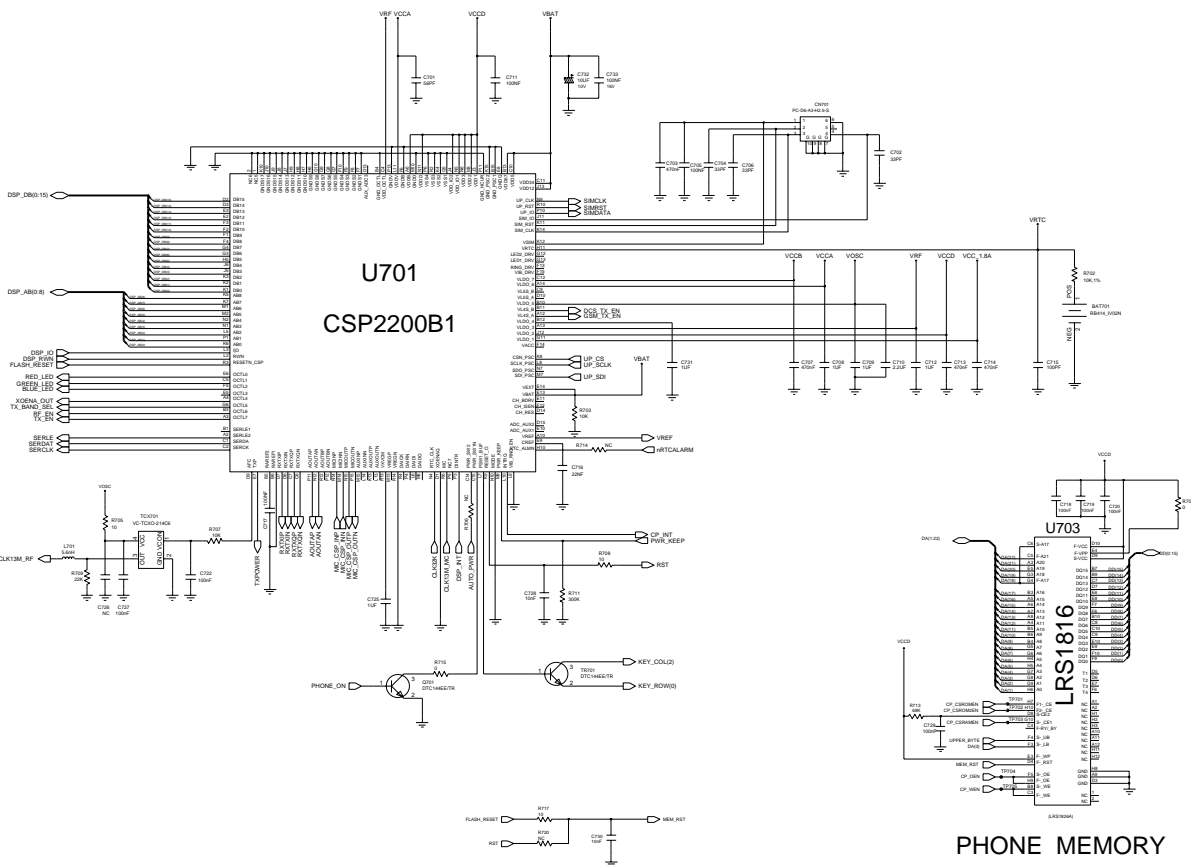

PHONE MEMORY

DESIGN	6-1553	CSP
REVISION	0-0-0-0-0	
MANUFACTURE	0-0-0-0-0	
DATE/TIME/USER		
BY		
PROJECT		
DATE		
TIME		
USER		
FILE		
DESCRIPTION		
Sheet	21	21

SGH-1300

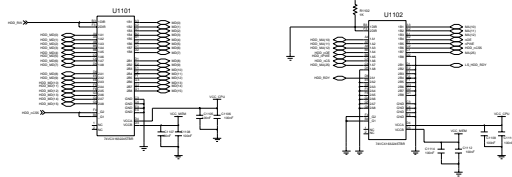

LEVEL SHIFTER (1.8V/3V)

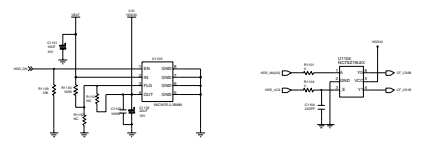

USB 1.1

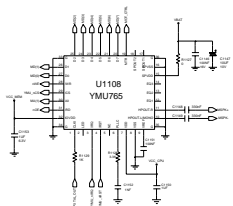

MELODY IC (64 POLY)

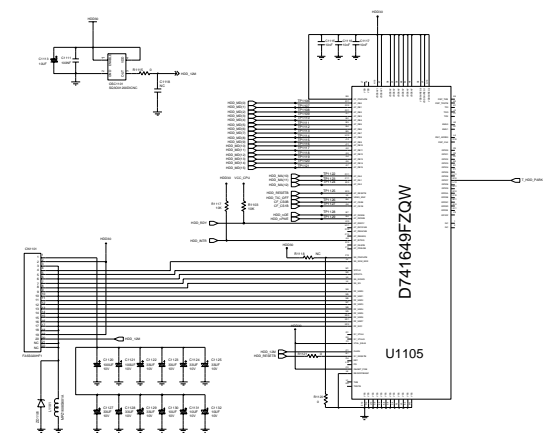

TIC (1.7)

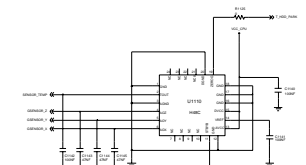

G & TEMP SENSOR