

SGH-E790_REV0.9

2006.11.08

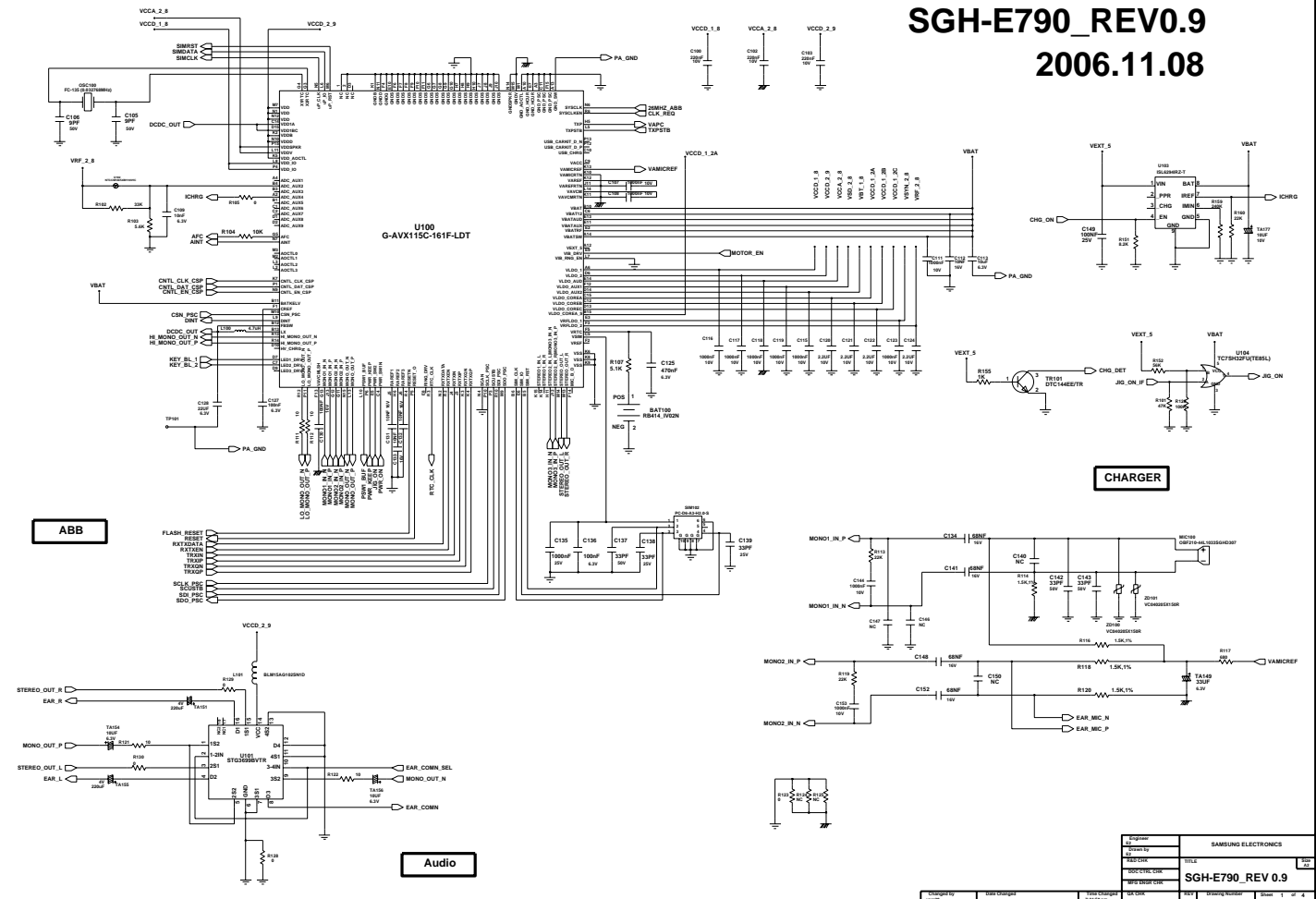

ABB

Audio

CHARGER

Engineer	SAMSUNG ELECTRONICS		
Design No.	SGH-E790		
Rev	0.9		
Doc No.	SGH-E790		
Doc Title	SGH-E790_REV0.9		
Design By	Doc No	Doc Rev	Doc Date
Doc No	Doc Rev	Doc Date	Doc Date

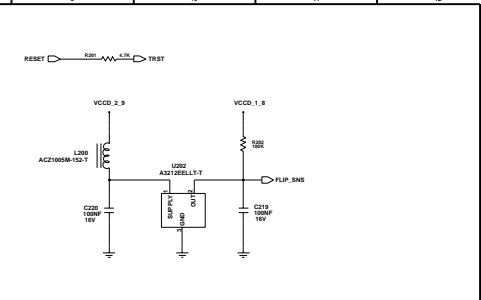
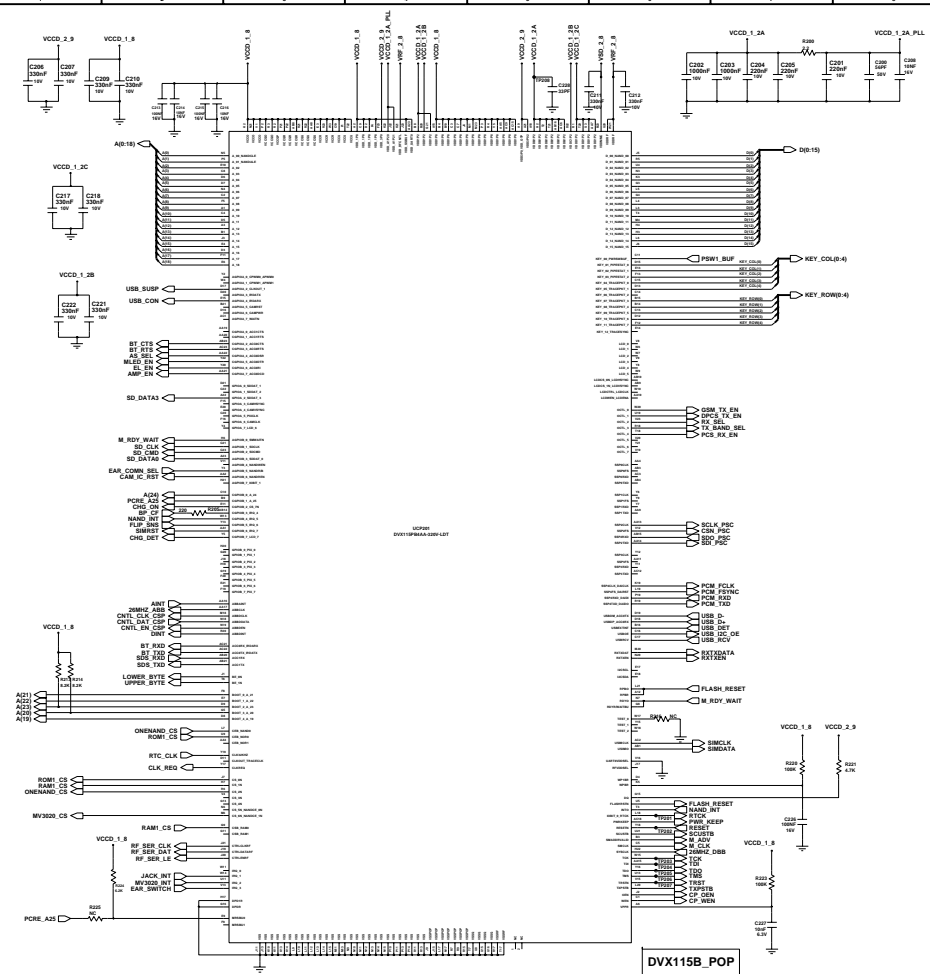

F SENSE

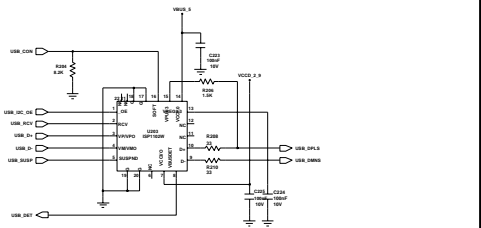

USB

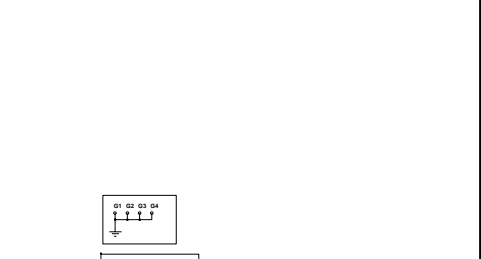

BOTHHOLE

DVX115B_POP

Engineer	SAMSUNG ELECTRONICS		
Checked by			
Designed by			
Specified by	TITLE		
Manufactured by	REV		
DR CLK	SGH-E790_REV 0.9		
DATE	DATE	ISSUE NO	ISSUE DATE

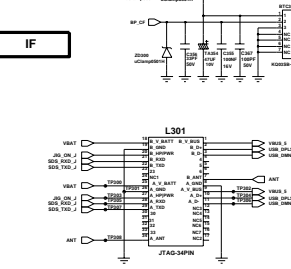
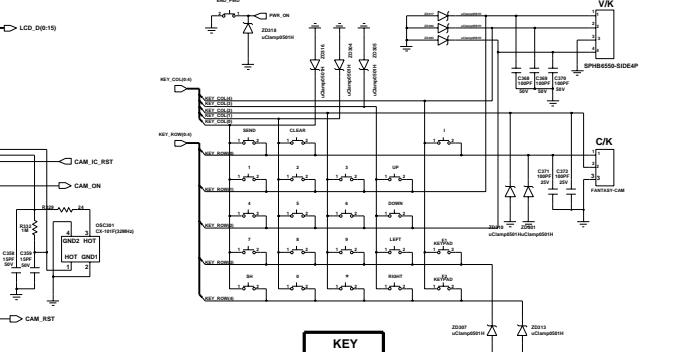
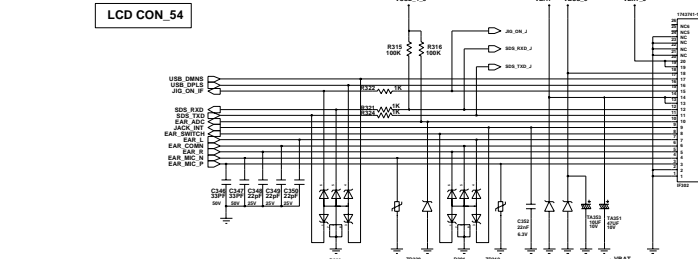
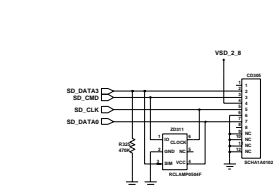
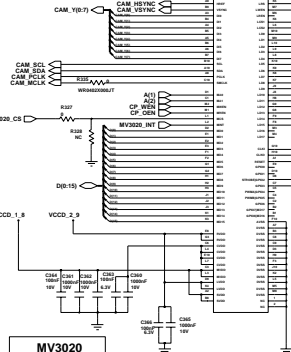
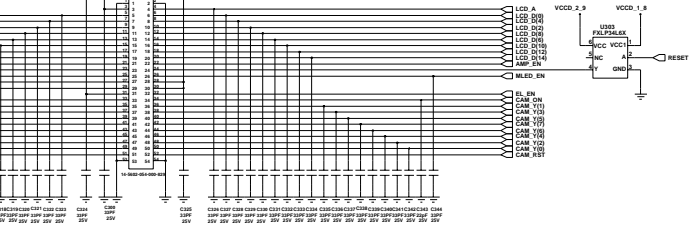
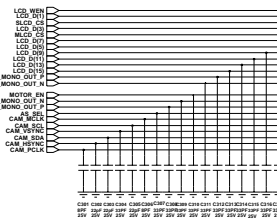
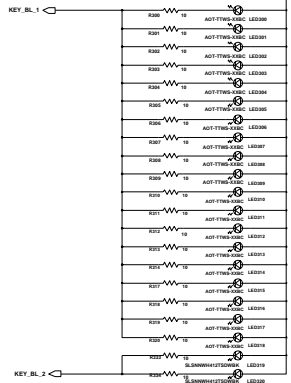

MV3020

KEY

IF

LCD CON_54

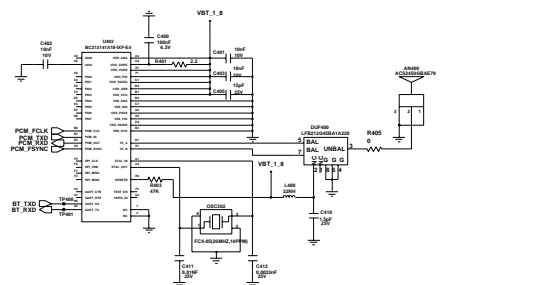

BT

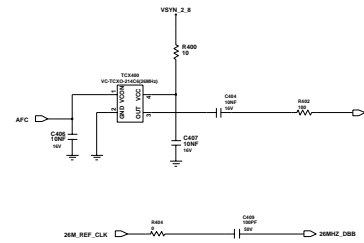

26M XTAL

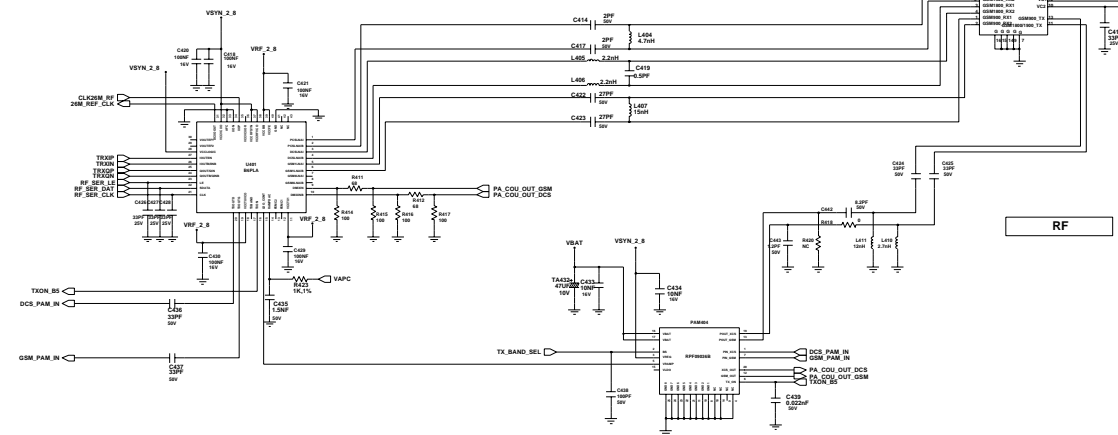

RF

SAMSUNG ELECTRONICS	
Product No.	MODEL
Part No.	REV
SGH-E790_REV 0.9	
DATE	REV
DESIGNED BY	DATE
CHECKED BY	DATE
APPROVED BY	DATE
DATE	REV

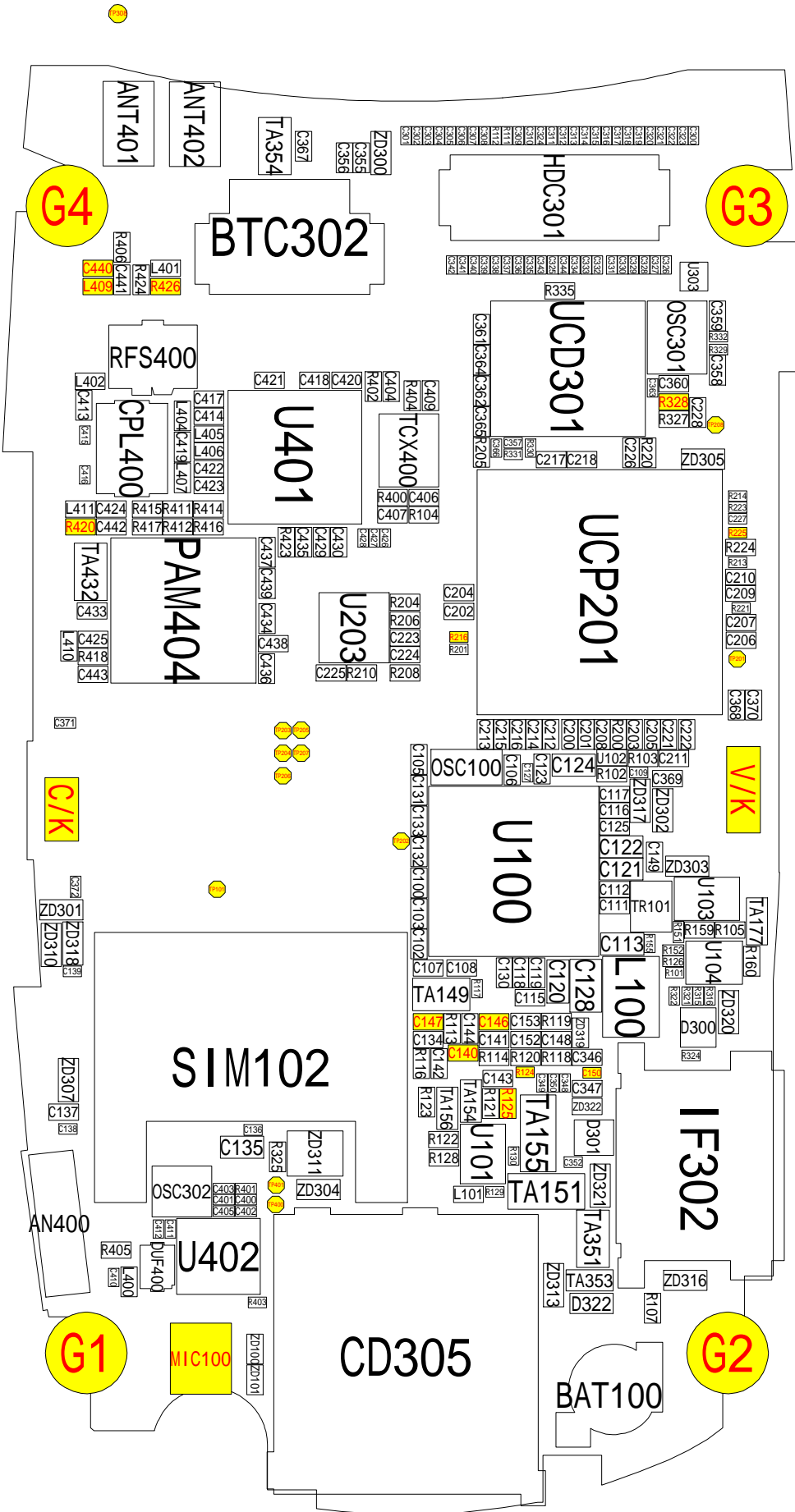

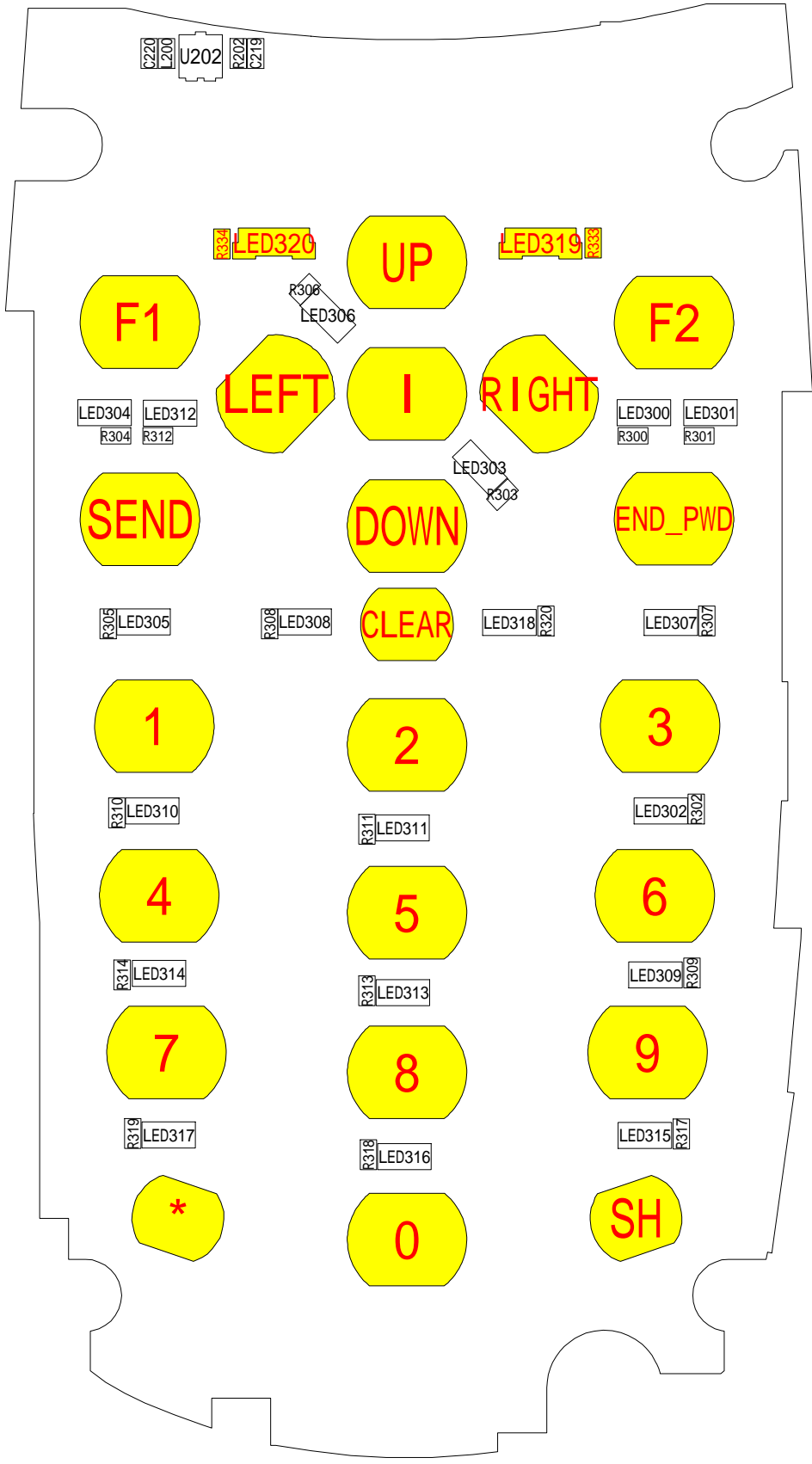

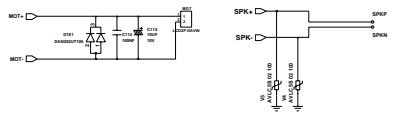
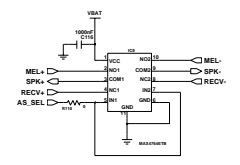
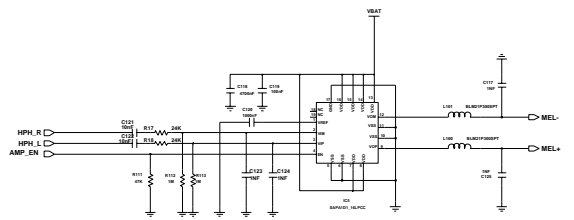
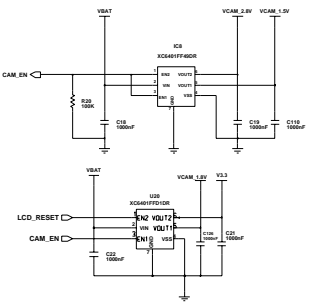
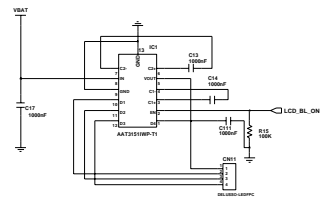
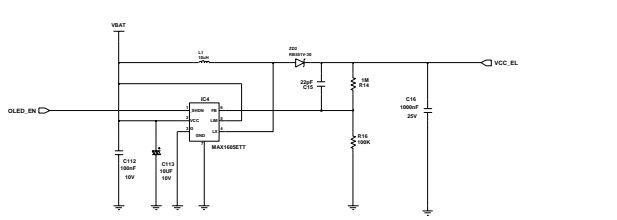
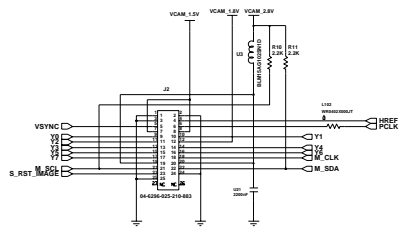
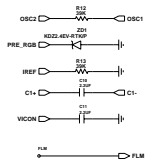
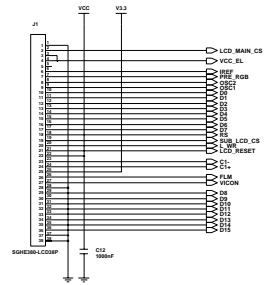
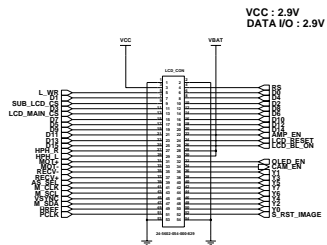

Engineer	COMPANY NAME		
Drawn by	Address City		
R&D CHK	TITLE	Size D	
DOC CTRL CHK	SGH-E790_LCD_R06		
MFG CTRL CHK			
QA CHK	REV	Drawing Number	Sheet of

Changed by user02 Date Changed 2006.06.23 Time 4:09:14 pm

결재	입안	심사	결정

작업지도서

2008년 10월 18일

S E C

SGH-E790 IF 부품배치도 REV0.6 TOP

-주의 사항-

1. 부품의 오삽 및 역삽 확인
2. 납땜 후 냉납, 미납 확인
3. 미삽 point는 작업지도서 확인
 : N.C : 극성
4. 작업전 반드시 Part List 확인

< REV0.5 대비 변경 사항 >

- C10, C11 자재확인!!
2203-006460
- 부품 변경
L102 : 2007-000171 0옴
- 실크 변경

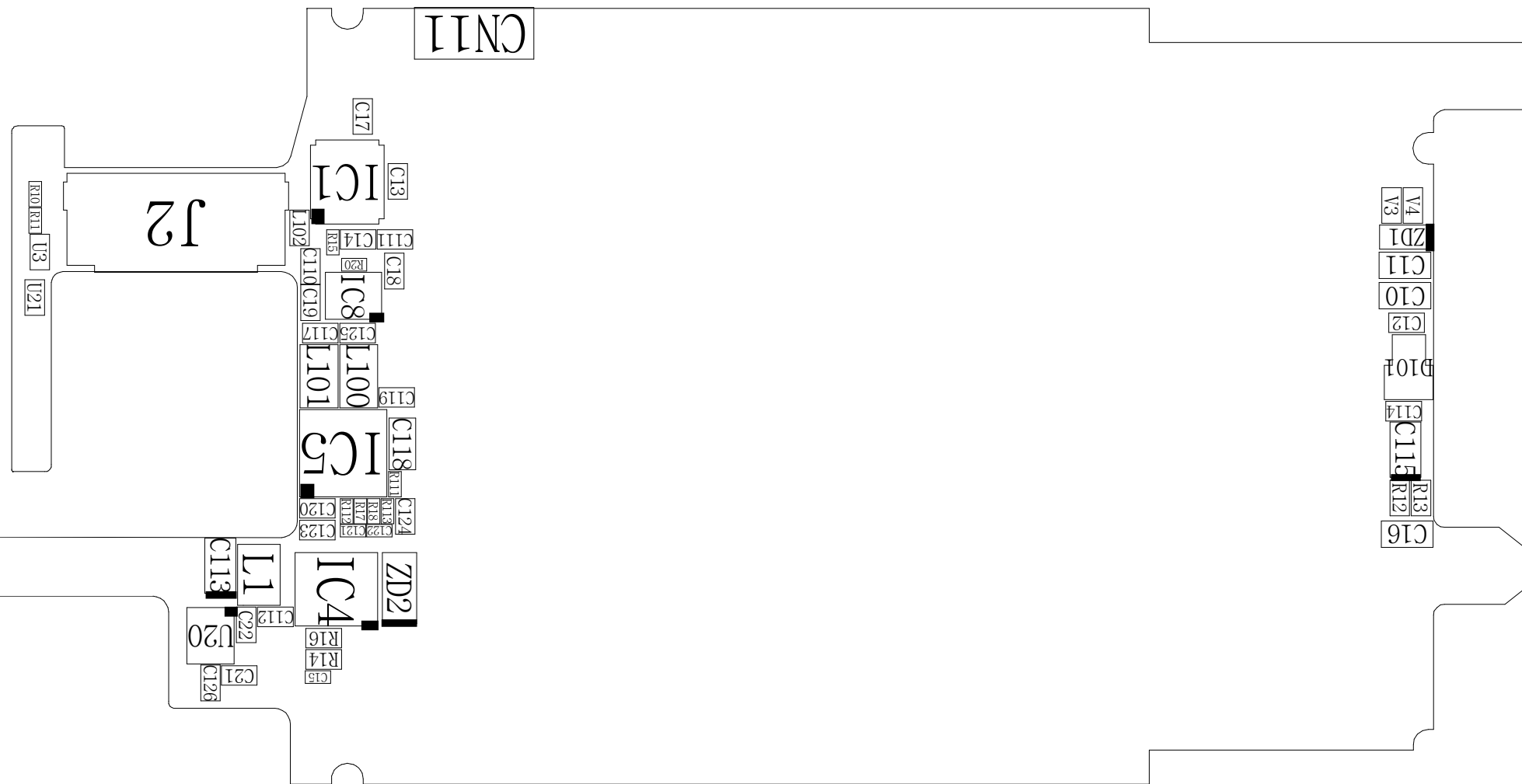

PCB 자재 CODE

NO	품명	CODE-NO	규격	수량
1	E790 IF	GH59-03589A		
2				
년.월.일	변경내용 및 주의 사항		확인	
09.01	IF FPCB REV0.4		전기철	
09.16	IF FPCB REV0.5		전기철	
10.18	IF FPCB REV0.6		전기철	

결 재	입 안	심 사	결 정

작업 지도서

2008년 10월 18일

S E C

SGH-E790 IF 부품배치도 REV0.6 BTM

-주의 사항-

1. 부품의 오삽 및 역삽 확인
2. 납땜 후 냉납, 미납 확인
3. 미삽 point는 작업지도서 확인

■ : N.C ■ : 극성

4. 작업전 반드시 Part List 확인

< REV0.5 대비 변경 사항 >

- C10, C11 자재확인!!
2203-006460
- 부품 변경
L102 : 2007-000171 0옴
- 실크 변경

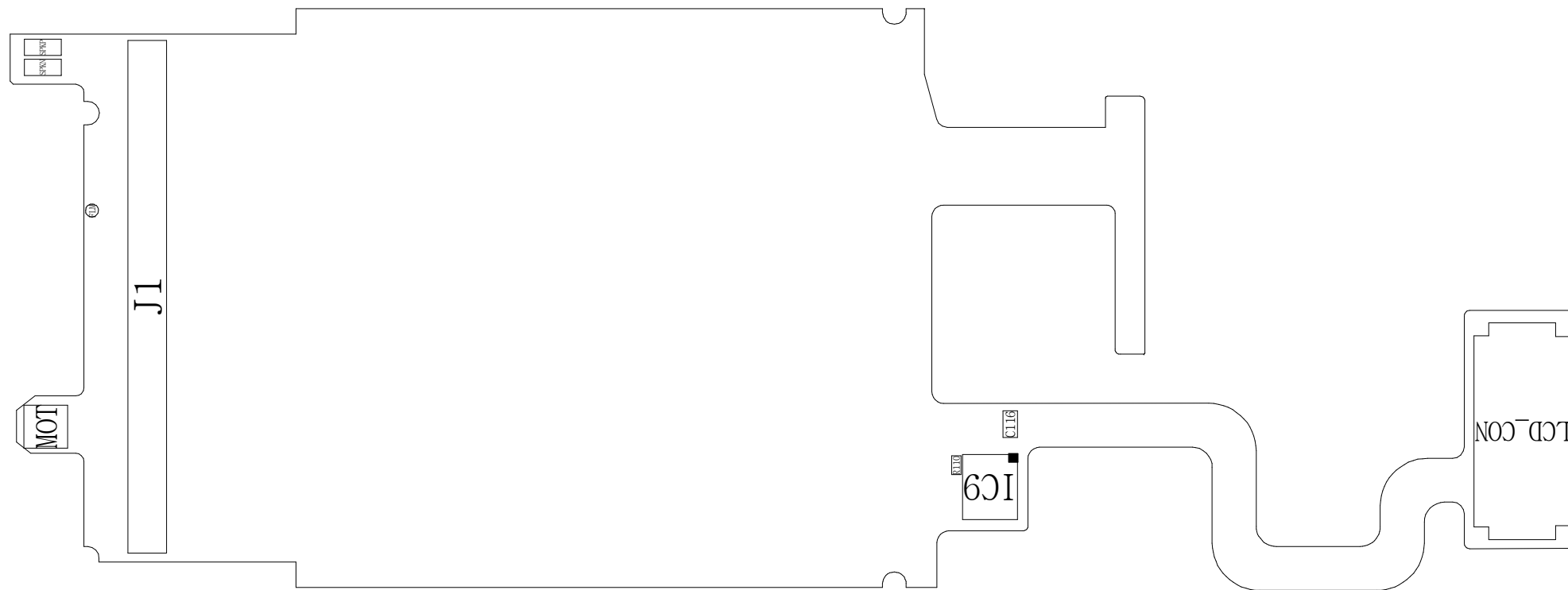

PCB 자재 CODE

NO	품 명	CODE-NO	규 격	수 량
1	E790 IF	GH59-03589A		
2				
년.월.일	변경내용 및 주의 사항			확인
09.01	IF FPCB REV0.4			전기철
09.16	IF FPCB REV0.5			전기철
10.18	IF FPCB REV0.6			전기철