

| | |
|--------------|--------------|
| Project: | COMPANY NAME |
| Drawn by: | Address |
| Check by: | City |
| Approved by: | State |
| Scale: | DATE |
| SGH-E720 | |

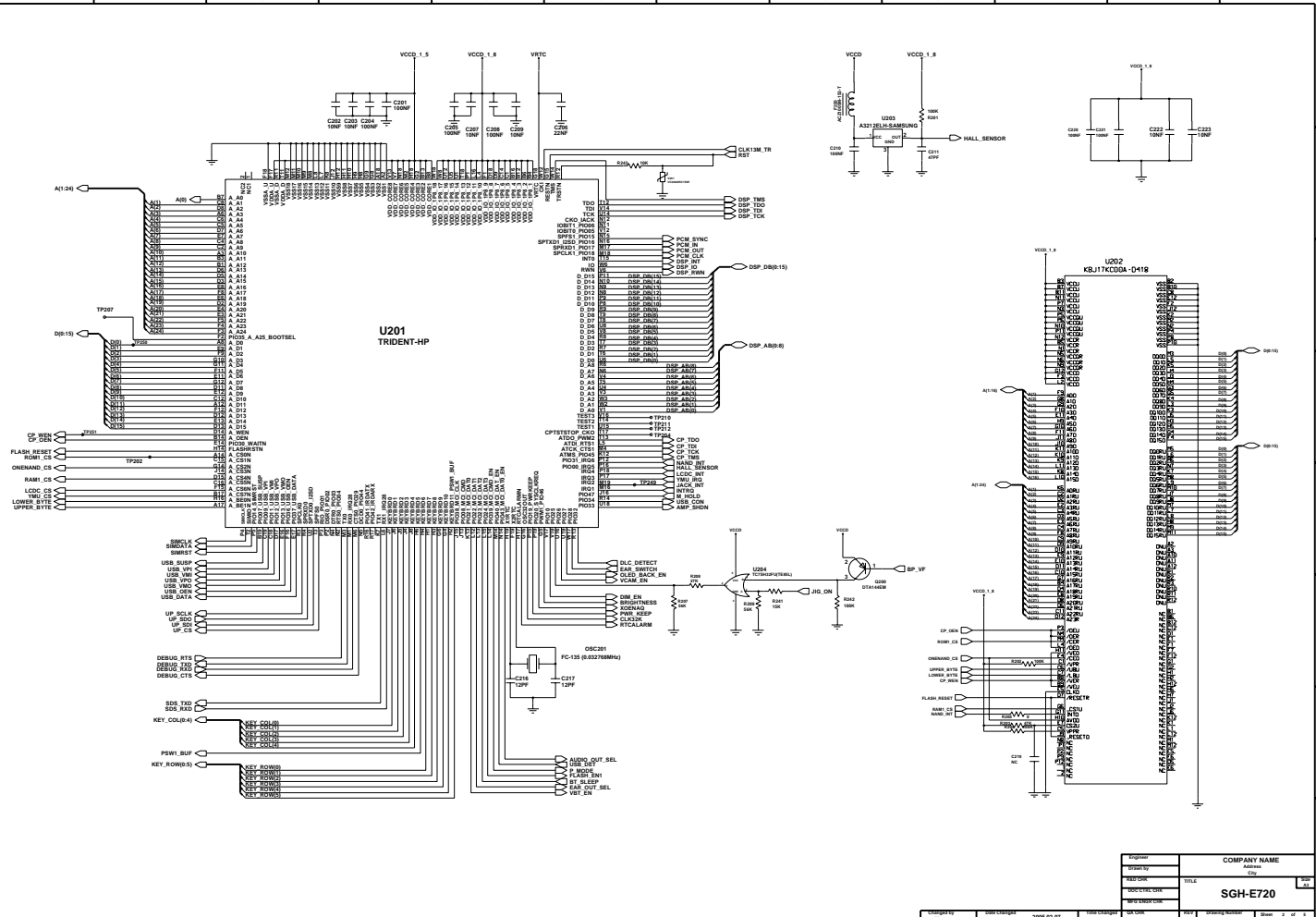

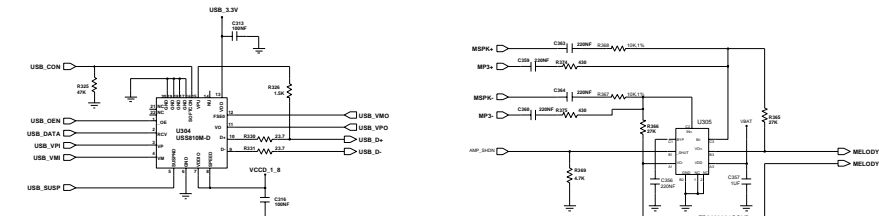

| | |
|-------------|--------------|
| DESIGNED BY | COMPANY NAME |
| DRAWN BY | ADDRESS |
| DATE | CITY |
| REVISION | TITLE |
| DATE | NO. |
| APPROVED BY | SGH-E720 |
| DATE | |

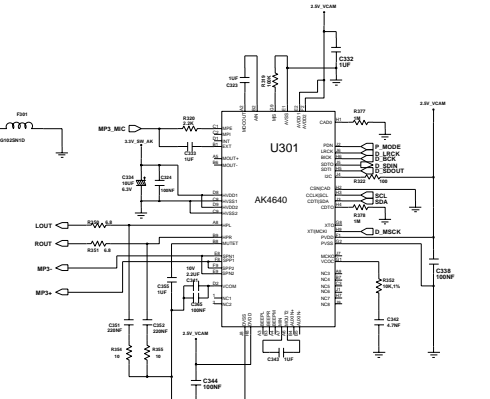
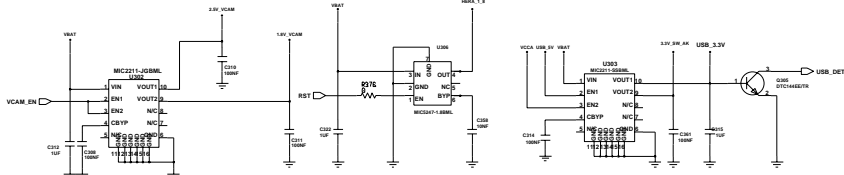
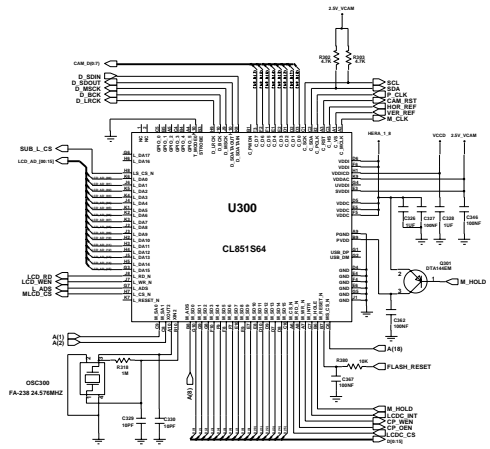
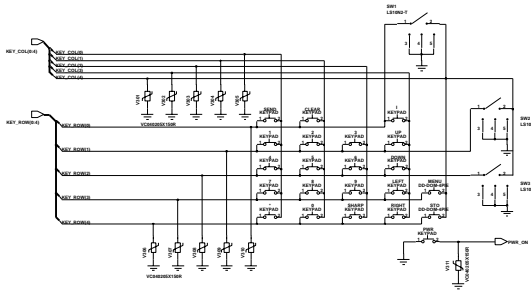
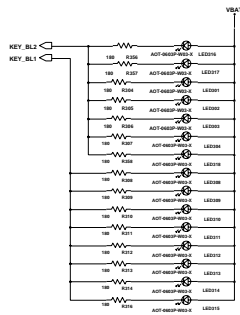
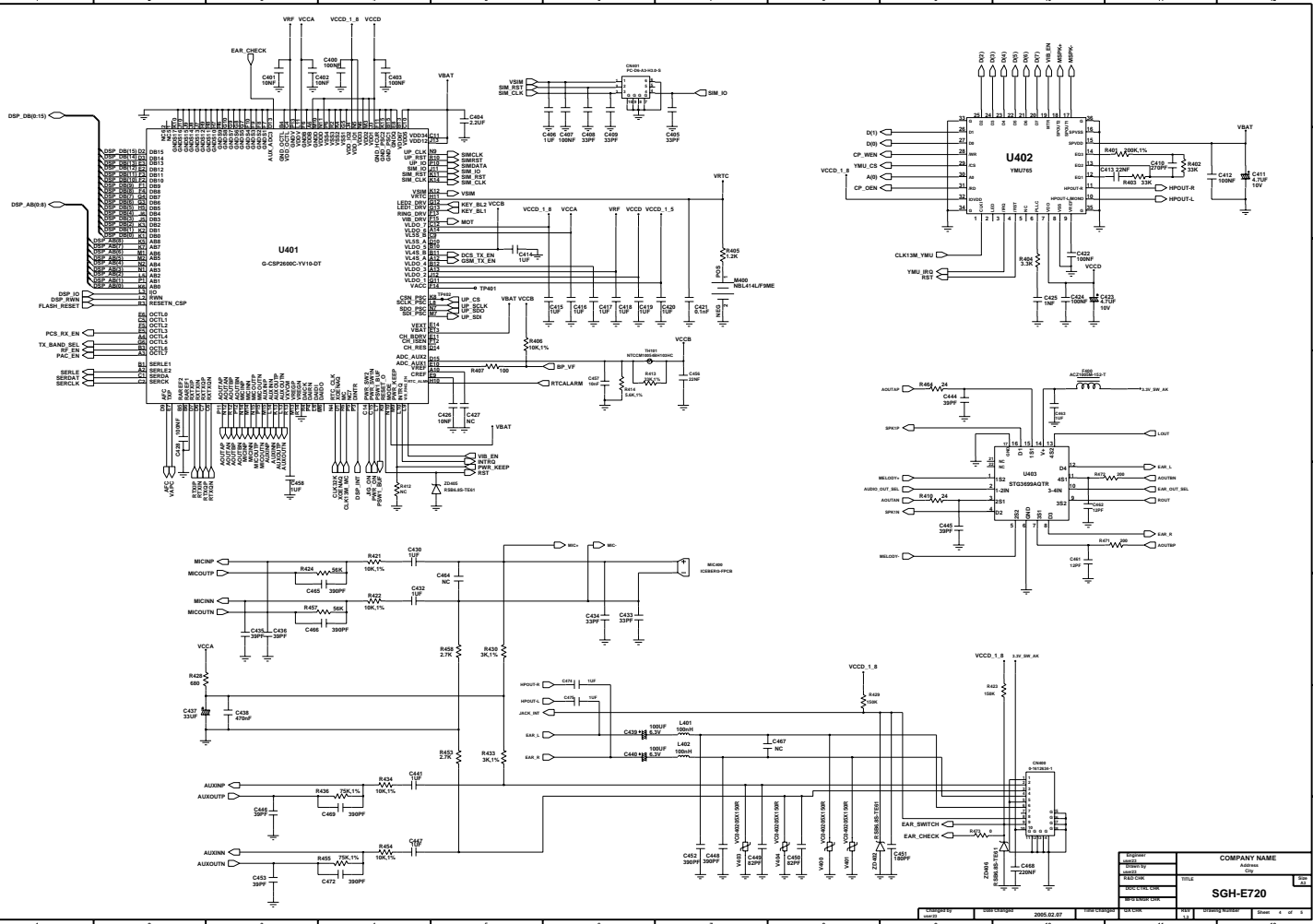

| | |
|------------------|--------------|
| DESIGNED BY | COMPANY NAME |
| DRAWN BY | Address |
| DATE | CITY |
| PROJECT CODE | TITLE |
| REV. NO. | DATE |
| REV. DESCRIPTION | REV. NO. |

SGH-E720

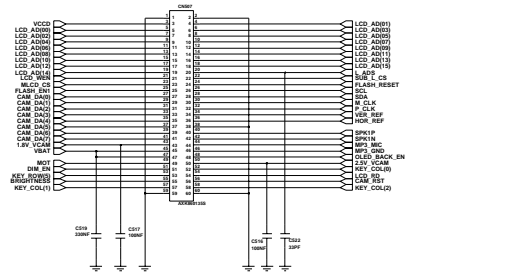
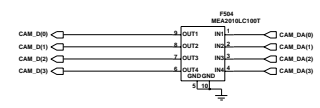
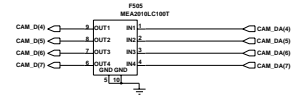
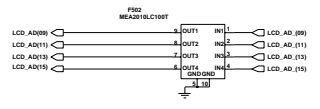
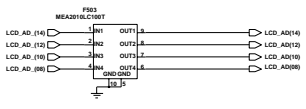
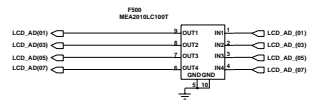
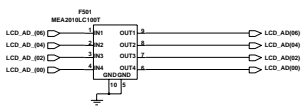
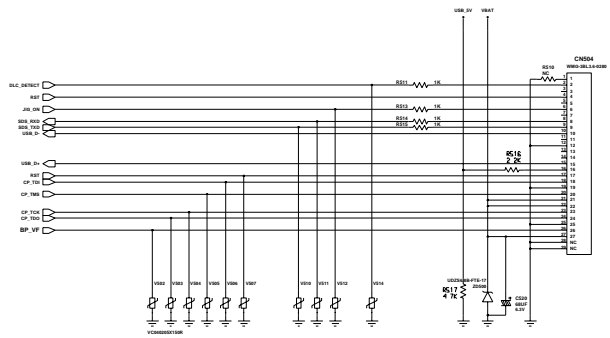
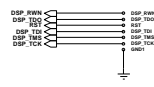
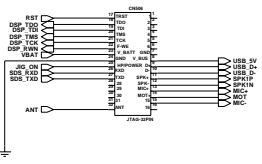

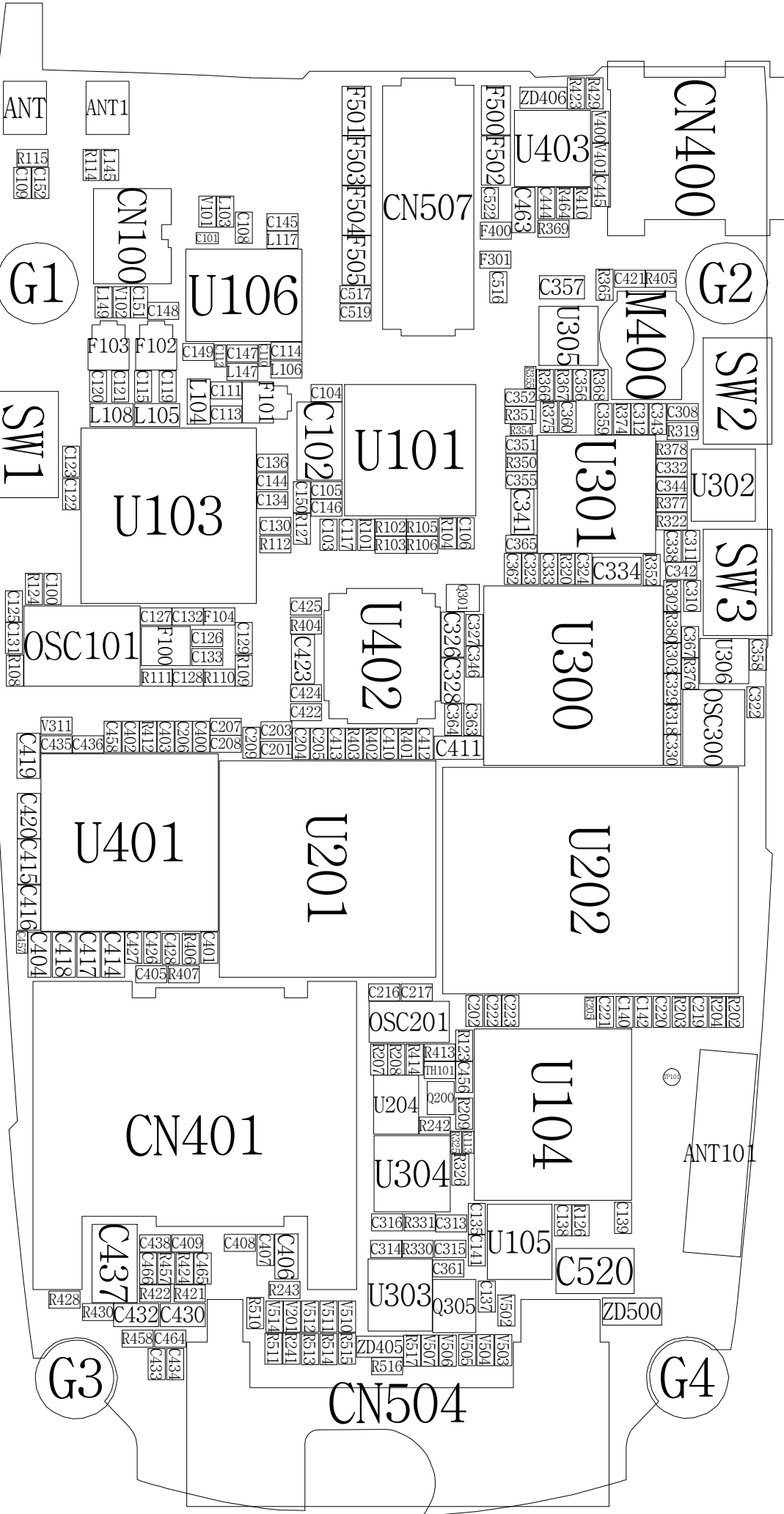

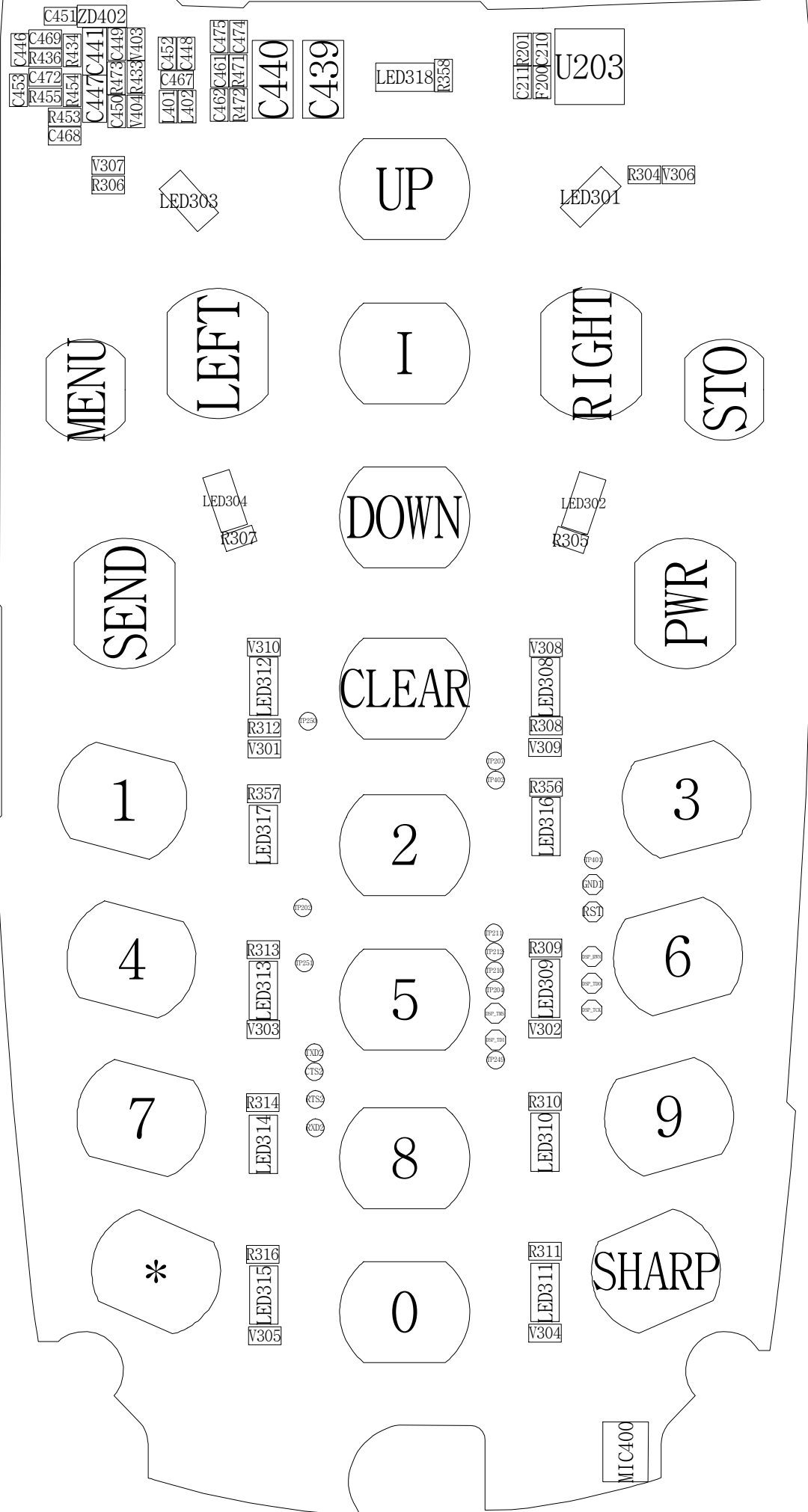

C451 ZD402
 C446 C469
 R436 R437
 C472 R454
 R455 R454
 R453 C447
 C447 C441
 C450 R473 C449
 V404 R433 V403
 C468

V307
 R306
 LED303

UP

C211 R201
 F200 C210
 U203

LED301 R304 V306

MENU

LEFT

I

RIGHT

STO

LED304
 R307

DOWN

LED302
 R305

SEND

PWR

V310
 LED312
 R312
 V301

CLEAR

V308
 LED308
 R308
 V309

1

2

3

R357
 LED317

FP200
 FP402

R356
 LED316

4

5

6

R313
 LED313
 V303

FP202

FP211
 FP212
 FP213
 FP214
 FP215
 FP216
 FP217
 FP218
 FP219
 FP220

R309
 LED309
 V302

FP400
 END1
 RST
 BEP_300
 BEP_301
 BEP_302
 BEP_303

7

8

9

R314
 LED314

END2
 FRC
 RST2

R310
 LED310

*

0

SHARP

R315
 LED315
 V305

R311
 LED311
 V304

MIC400