

Engineer	SAMSUNG ELECTRONICS
Design by	
Rev	
Part Name	E610_REV1.7
Part Number	
Manufacturer	

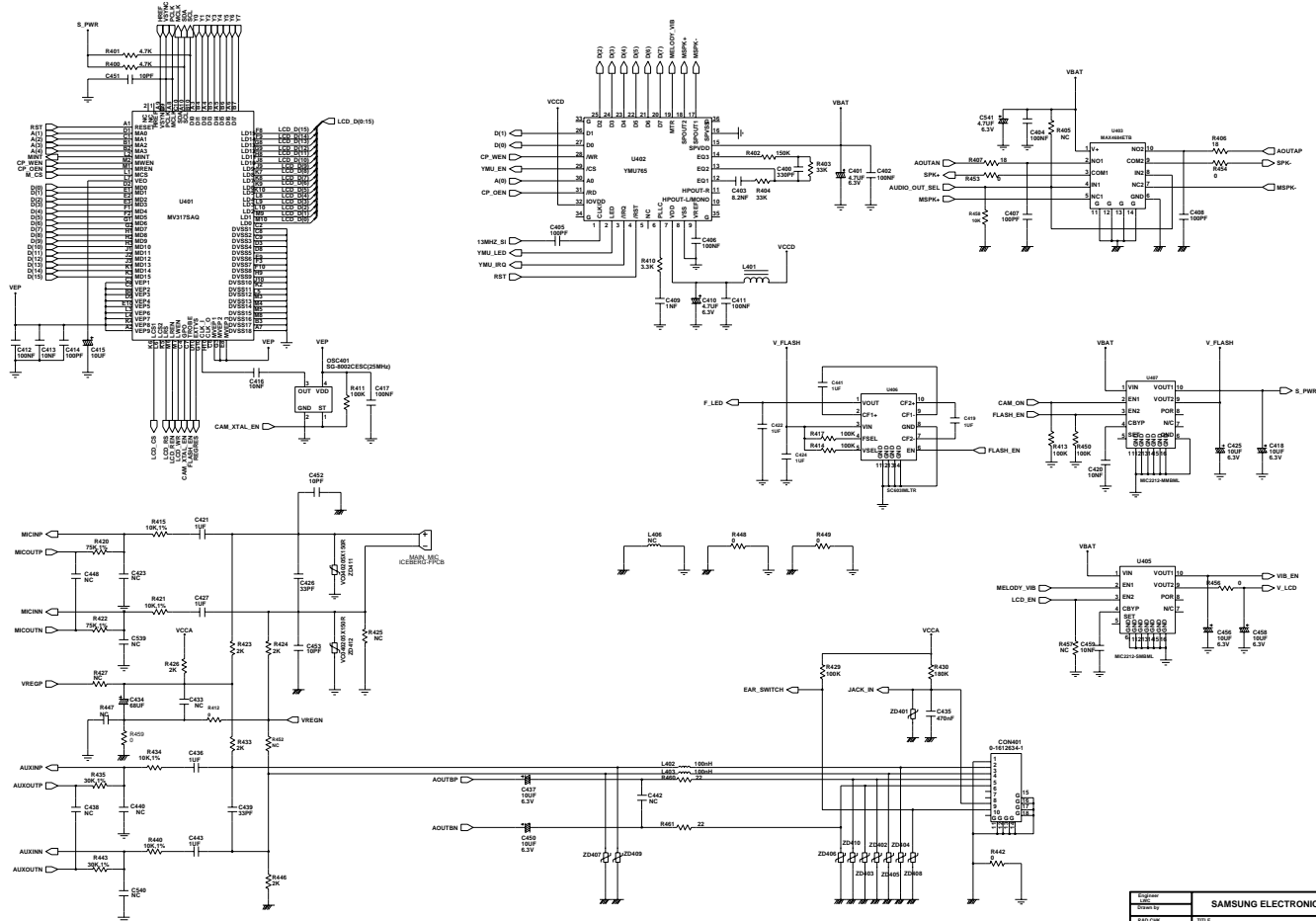

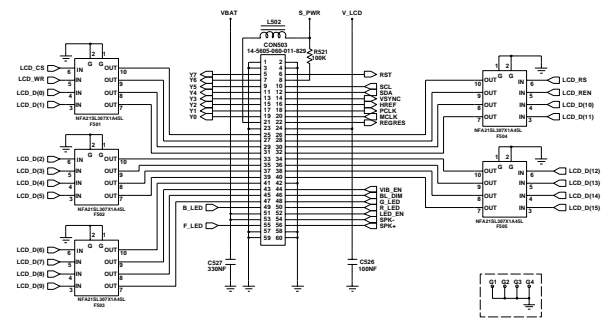

Engineer		SAMSUNG ELECTRONICS	
Design by			
Rev. Date		TITLE	
Approved by		E610 REV.1.7	
Checked by		MV317 & YM766 & AUDIO	
Design No.	00210294	Date	2004.11.17
Drawn by		Time	
Checked by		SA Desk	
Approved by		1st	Signing Manager
		Sheet	12

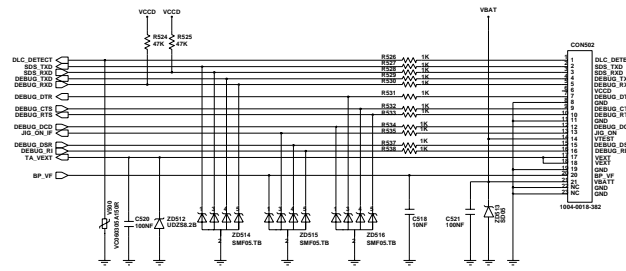
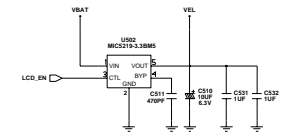
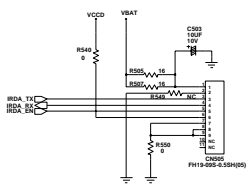
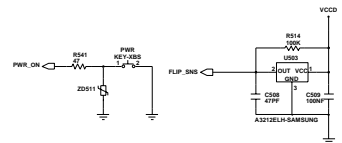
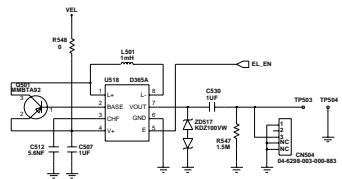
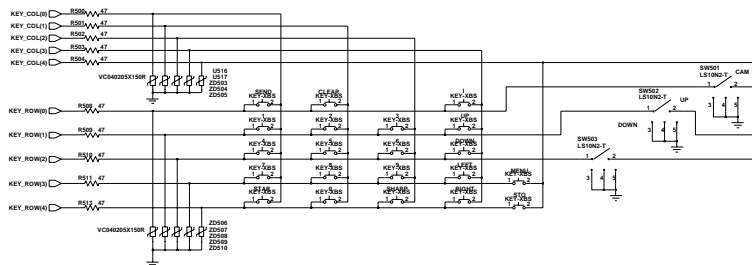

Prepared by	SAMSUNG ELECTRONICS
Drawn by	
Checked by	TITLE
Approved by	<b>E610_REV1.7</b>
	(CONNECTOR & ETC)

