

SAMSUNG

GSM TELEPHONE

SGH-E370

SERVICE *Manual*

GSM TELEPHONE



CONTENTS

1. Safety Precautions
2. Specification
3. Product Function
4. Array course control
5. Exploded View and Parts List
6. MAIN Electrical Parts List
7. Block Diagrams
8. PCB Diagrams
9. Flow Chart of Troubleshooting
10. Reference data
11. Disassembly and Assembly Instructions

CONTENTS

1. Safety Precautions

- 1-1. Repair Precaution1-1
- 1-2. ESD(Electrostatically Sensitive Devices) Precaution1-2

2. Specification

- 2-1. GSM General Specification2-1
- 2-2. GSM Tx Power Class2-2

3. Product Function

4. Array course control

- 4-1. Software Adjustments.....4-1
- 4-2. Software Downloading.....4-2

5. Exploded View and Parts List

- 5-1. Cellular phone Exploded View5-1
- 5-2. Cellular phone Parts list5-2

6. MAIN Electrical Parts List

7. Block Diagrams

8. PCB Diagrams

- 8-1. Main PCB Diagrams.....8-1
 - 8-2. Sub PCB Diagrams.....8-3
-

CONTENTS

9. Flow Chart of Troubleshooting

9-1. Power On.....	9-1
9-2. Initial	9-3
9-3. Charging Part.....	9-5
9-4. Sim Part.....	9-7
9-5. Microphone Part.....	9-9
9-6. Speaker Part(Melody).....	9-11
9-7. Key Data Input.....	9-13
9-8. Receiver Part.....	9-14
9-9. Back Light (for Color Main LCD).....	9-15
9-10. Key Back Light.....	9-17
9-11. Camera Part.....	9-18
9-12. GSM Receiver.....	9-20
9-13. GSM Transmitter.....	9-21
9-14. DCS Receiver.....	9-22
9-15. DCS Transmitter.....	9-23
9-16. PCS Receiver.....	9-24
9-17. PCS Transmitter.....	9-25

10. Reference data

11. Disassembly and Assembly Instructions

11-1. Disassembly.....	11-1
11-2. Assembly.....	11-3
11-3. FPCB KIT Assembly.....	11-5
11-4. LCD KIT Assembly	11-8

1. Safety Precautions

1-1. Repair Precaution

- Repair in Shield Box, during detailed tuning.
Take specially care of tuning or test,
because specipicty of cellular phone is sensitive for surrounding interference(RF noise).
- Be careful to use a kind of magnetic object or tool,
because performance of parts is damaged by the influence of magnetic force.
- Surely use a standard screwdriver when you disassemble this product,
otherwise screw will be worn away.
- Use a thicken twisted wire when you measure level.
A thicken twisted wire has low resistance, therefore error of measurement is few.
- Repair after separate Test Pack and Set because for short danger (for example an
overcurrent and furious flames of parts etc) when you repair board in condition of
connecting Test Pack and tuning on.
- Take specially care of soldering, because Land of PCB is small and weak in heat.
- Surely tune on/off while using AC power plug, because a repair of battery charger is
dangerous when tuning ON/OFF PBA and Connector after disassembling charger.
- Don't use as you pleases after change other material than replacement registered on SEC System.
Otherwise engineer in charge isn't charged with problem that you don't keep this rules.

1-2. ESD(Electrostatically Sensitive Devices) Precaution

Several semiconductor may be damaged easily by static electricity. Such parts are called by ESD (Electrostatically Sensitive Devices), for example IC,BGA chip etc. Read Precaution below. You can prevent from ESD damage by static electricity.

- Remove static electricity remained your body before you touch semiconductor or parts with semiconductor. There are ways that you touch an earthed place or wear static electricity prevention string on wrist.
- Use earthed soldering steel when you connect or disconnect ESD.
- Use soldering removing tool to break static electricity. , otherwise ESD will be damaged by static electricity.
- Don't unpack until you set up ESD on product. Because most of ESD are packed by box and aluminum plate to have conductive power,they are prevented from static electricity.
- You must maintain electric contact between ESD and place due to be set up until ESD is connected completely to the proper place or a circuit board.

2. Specification

2-1. GSM General Specification

	GSM900 Phase 1	EGSM 900 Phase 2	DCS1800 Phase 1	PCS1900
Freq. Band[MHz] Uplink/Downlink	890~915 935~960	880~915 925~960	1710~1785 1805~1880	1850~1910 1930~1990
ARFCN range	1~124	0~124 & 975~1023	512~885	512~810
Tx/Rx spacing	45MHz	45MHz	95MHz	80MHz
Mod. Bit rate/ Bit Period	270.833kbps 3.692us	270.833kbps 3.692us	270.833kbps 3.692us	270.833kbps 3.692us
Time Slot Period/Frame Period	576.9us 4.615ms	576.9us 4.615ms	576.9us 4.615ms	576.9us 4.615ms
Modulation	0.3GMSK	0.3GMSK	0.3GMSK	0.3GMSK
MS Power	33dBm~5dBm	33dBm~5dBm	30dBm~0dBm	30dBm~0dBm
Power Class	5pcl ~ 19pcl	5pcl ~ 19pcl	0pcl ~ 15pcl	0pcl ~ 15pcl
Sensitivity	-102dBm	-102dBm	-100dBm	-100dBm
TDMA Mux	8	8	8	8
Cell Radius	35Km	35Km	2Km	-

2-2. GSM Tx Power Class

TX Power control level	GSM900	TX Power control level	DCS1800	TX Power control level	PCS1800
5	33±2 dBm	0	30±3 dBm	0	30±3 dBm
6	31±2 dBm	1	28±3 dBm	1	28±3 dBm
7	29±2 dBm	2	26±3 dBm	2	26±3 dBm
8	27±2 dBm	3	24±3 dBm	3	24±3 dBm
9	25±2 dBm	4	22±3 dBm	4	22±3 dBm
10	23±2 dBm	5	20±3 dBm	5	20±3 dBm
11	21±2 dBm	6	18±3 dBm	6	18±3 dBm
12	19±2 dBm	7	16±3 dBm	7	16±3 dBm
13	17±2 dBm	8	14±3 dBm	8	14±3 dBm
14	15±2 dBm	9	12±4 dBm	9	12±4 dBm
15	13±2 dBm	10	10±4 dBm	10	10±4 dBm
16	11±3 dBm	11	8±4dBm	11	8±4dBm
17	9±3dBm	12	6±4 dBm	12	6±4 dBm
18	7±3 dBm	13	4±4 dBm	13	4±4 dBm
19	5±3 dBm	14	2±5 dBm	14	2±5 dBm
		15	0±5 dBm	15	0±5 dBm

3. Product Function

Main Function

- 1.3 Megapixel Camera with Flash
- 65536 Color TFT Screen (128×160)
- Video Recording & Messaging
- Music Player(MP3/AAC/AAC+)
- Bluetooth Woreless Technology
- Multimedia Message Service (MMS)
- E-mail
- Voice recorder
- Java / WAP2.0
- Tri-band(900/1800/1900MHz)

4. Array course control

4-1. Software Downloading

Test Jig (GH80-03306A)



Test Cable(GH39-00337C)



Serial Cable(CSA LL64151-A)



Power Supply Cable



4-2. Software Downloading

4-2-1. Pre-requisite for Downloading

- Downloader Program([OneNAND_Downloader_1.8.exe](#))
- E370 Mobile Phone
- Data Cable
- Binary file, TFS file

4-2-2. S/W Downloader Program

■ Load the binary download program by executing the "[OneNAND_Downloader_1.8.exe](#)"

1. Select the connected serial port and the rate of speed
2. Select the check box, the mode you want to download.
 - if the binary file wanted, check only 'BIN'
 - if the tfs file wanted, check only 'TFS'
 - if all the files wanted, check 'BIN+TFS'

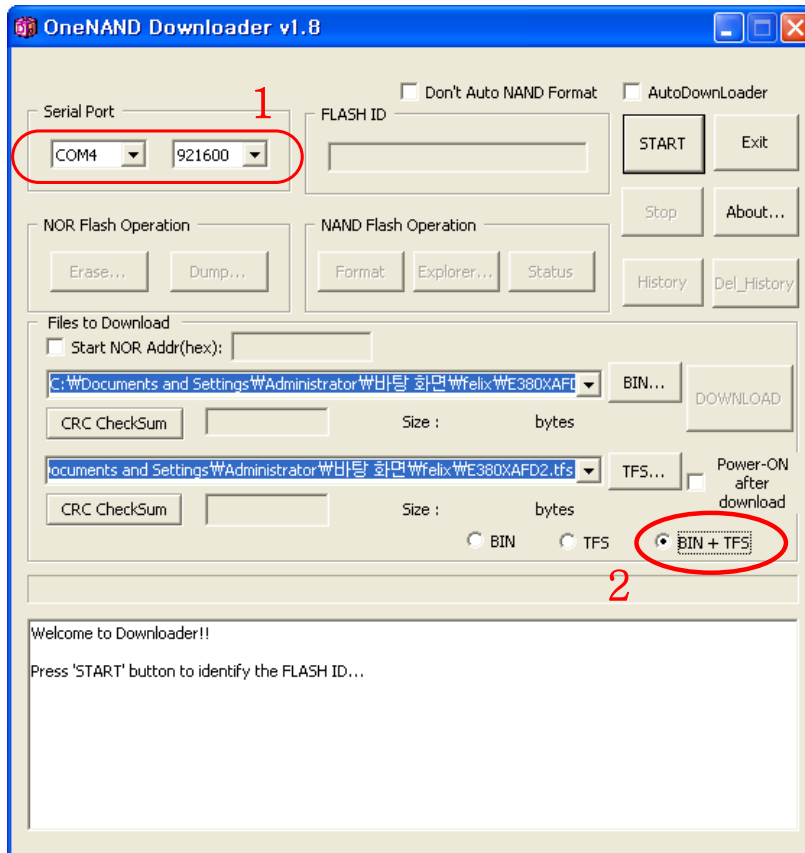

3. Select the file(s) what you want to download

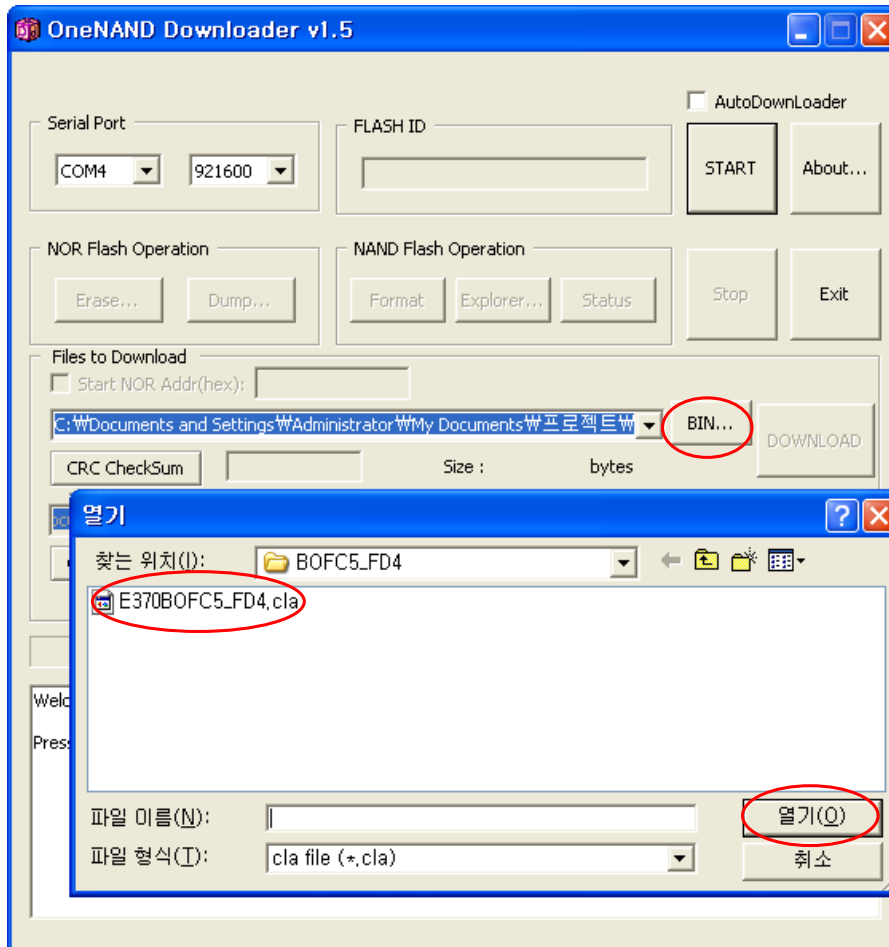

5. Exploded View and Parts List

5-1. Cellular phone Exploded View

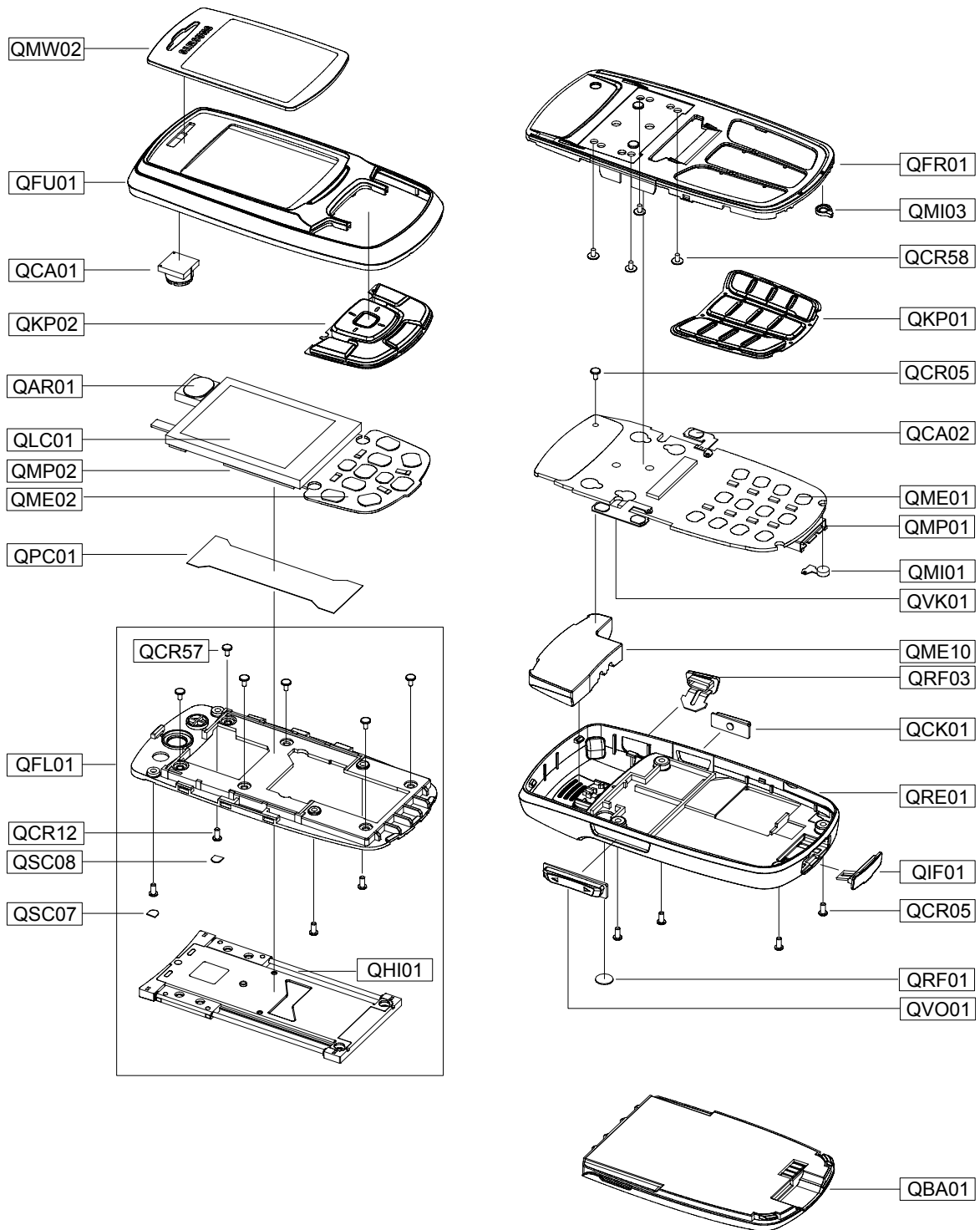

5-2. Cellular phone Parts list

Design LOC	Description	SEC Code	
QAR01	AUDIO-RECEIVER	3009-001187	
QBA01	BATTERY-800MAH,BLACK,MAIN	GH43-02326A	
QCA01	UNIT-CAMERA	GH59-02946A	
QCA02	UNIT-CAMERA KEY	GH59-02841A	
QCR05	SCREW-MACHINE	6001-001478	
QCR12	SCREW-MACHINE	6001-001530	
QCR58	SCREW-MACHINE	6001-001870	
QFU01	MEC-CASE SLIDE UPPER	GH75-08778A	
QIF01	PMO-COVER IF	GH72-27571A	
QKP01	MEC-KEYPAD MAIN	GH75-08776A	
QKP02	ASSY-KEY-KEYPAD SUB	GH98-01062A	
QLC01	MEA-LCD MODULE KIT	GH97-05867A	
QME01	UNIT-MAIN METAL DOME	GH59-02842A	
QME02	UNIT-SUB METAL DOME	GH59-02843A	
QME10	UNIT-MFA INTENNA MODULE	GH59-03138A	
QMI01	MICROPHONE-ASSY	GH30-00269A	
QMP01	PBA MAIN-SGH E370	GH92-02638A	
QMP02	PBA MAIN-SGH E370 SUB	GH92-02654A	
QMW02	PCT-MAIN WINDOW(T MOBILE)	GH72-30863A	
QPC01	MEA-SLIDE FPCB KIT	GH97-05868A	
QRF01	MPR-SHEET COVER RF	GH74-23036A	
QSC07	MPR-SHEET LOWER SCREW CAP(L)	GH74-23028A	
QSC08	MPR-SHEET LOWER SCREW CAP(R)	GH74-23029A	
QVK01	UNIT-VOLUME KEY	GH59-02840A	
QRE01	MEC-CASE REAR	GH75-08782A	
	QCK01	PMO-SIDE KEY	GH72-27569A
	QRF03	PMO-COVER EARPHONE	GH72-27568A
	QVO01	PMO-CAMERA KEY	GH72-27570A
QFL01	MEC-CASE SLIDE LOWER	GH75-08780A	
	QCR57	SCREW-MACHINE	6001-002001
	QHI01	ASSY-COVER-SLIDE MODULE	GH98-00957A
QFR01	MEC-CASE FRONT	GH75-08775A	
	QMI03	ASSY-CUSHION-HOLDER MIC	GH98-00956A

Discription	SEC Code
BAG PE	6902-000634
ADAPTOR-SGHD500 BLK	GH44-00954A
UNIT-EARPHONE	GH59-02395A
SPRING ETC-BATT LOCKER	GH61-00120A
LABEL(P)-WATER SOAK	GH68-02026A
LABEL(P)-IMEI DI	GH68-03060A
LABEL(R)-MAIN(EU)	GH68-09319A
MANUAL USERS-EU TMOENGLISH	GH68-09898A
MANUAL USERS-EU TMOGERMAN	GH68-09899A
CUSHION-CASE(T-MOBILE)	GH69-03063A
BOX(P)-UNIT(DTM)	GH69-03671H
MPR-VINYL BOHO LCD WIN	GH74-20869A
MPR-VINYL BOHO M/WIN INSIDE	GH74-23016A
MPR-VINYL BOHO MAIN WINDOW LIS	GH74-23030A
MPR-TAPE MAIN FPCB	GH74-23674A
MPR-TAPE MAIN DOME EMI	GH74-23675A
MPR-TAPE MAIN FPCB SHORT	GH74-23676A
MPR-TAPE MAIN FPCB EMI 2	GH74-23677A
MPR-TAPE SUB FPCB	GH74-23679A
MPR-TAPE LCD FPCB	GH74-23680A
MPR-TAPE SUB FPCB SHORT	GH74-23681A
MPR-TAPE LCD PBA SHORT	GH74-23682A
MPR-TAPE SUB DOME EMI	GH74-23683A
MPR-TAPE MAIN FPCB EMI 1	GH74-23684A
MPR-TAPE MAIN YAMAHA SHORT	GH74-23685A
MPR-TAPE MAIN J TAG	GH74-23686A
MPR-TAPE SLIDE MODULE EMI	GH74-23687A
MPR-TAPE SLIDE MODULE EMI	GH74-23687A
MPR-VINYL BOHO 3X4 KEY	GH74-23688A
MEC-HANGER	GH75-03673H

6. Electrical Parts List

Design LOC	Description	SEC CODE	STATUS
ANT300	ANTENNA-CHIP	4202-001157	SA
BAT400	BATTERY-LI(2ND)	4302-001180	SA
BTC501	HEADER-BATTERY	3711-006026	SA
C100	C-TA,CHIP	2404-001385	SA
C101	C-CER,CHIP	2203-000438	SA
C101	C-CER,CHIP	2203-000679	SA
C102	C-CER,CHIP	2203-000386	SA
C102	C-CER,CHIP	2203-006562	SA
C103	C-CER,CHIP	2203-000330	SA
C104	C-CER,CHIP	2203-000425	SA
C108	C-CER,CHIP	2203-000425	SA
C111	C-CER,CHIP	2203-000425	SA
C111	C-CER,CHIP	2203-006562	SA
C112	C-CER,CHIP	2203-000386	SA
C112	C-CER,CHIP	2203-006257	SA
C113	C-CER,CHIP	2203-006324	SA
C114	C-CER,CHIP	2203-000233	SA
C114	C-CER,CHIP	2203-006324	SA
C115	C-CER,CHIP	2203-000643	SA
C115	C-CER,CHIP	2203-006324	SA
C116	C-CER,CHIP	2203-000386	SA
C116	C-CER,CHIP	2203-006324	SA
C117	C-CER,CHIP	2203-000189	SA
C117	C-CER,CHIP	2203-000386	SA
C118	C-CER,CHIP	2203-000386	SA
C119	C-CER,CHIP	2203-000233	SA
C121	C-CER,CHIP	2203-006562	SA
C123	C-CER,CHIP	2203-000233	SA
C124	C-CER,CHIP	2203-001385	SA
C125	C-CER,CHIP	2203-001385	SA
C126	C-CER,CHIP	2203-000233	SA
C128	C-CER,CHIP	2203-000628	SA
C130	C-CER,CHIP	2203-000278	SA
C131	C-CER,CHIP	2203-005444	SA
C134	C-CER,CHIP	2203-000466	SA
C135	C-CER,CHIP	2203-001383	SA
C136	C-CER,CHIP	2203-000466	SA
C137	C-CER,CHIP	2203-000530	SA
C147	C-CER,CHIP	2203-002668	SA
C200	C-CER,CHIP	2203-000254	SA
C201	C-CER,CHIP	2203-005482	SA
C202	C-CER,CHIP	2203-005482	SA
C203	C-CER,CHIP	2203-000812	SA
C204	C-CER,CHIP	2203-005482	SA
C205	C-CER,CHIP	2203-000254	SA

Electrical Parts List

Design LOC	Description	SEC CODE	STATUS
C206	C-CER,CHIP	2203-005482	SA
C207	C-CER,CHIP	2203-000254	SA
C208	C-CER,CHIP	2203-005482	SA
C209	C-CER,CHIP	2203-006208	SA
C210	C-CER,CHIP	2203-000812	SA
C211	C-CER,CHIP	2203-005482	SA
C212	C-CER,CHIP	2203-006562	SA
C213	C-CER,CHIP	2203-006562	SA
C214	C-CER,CHIP	2203-006562	SA
C216	C-CER,CHIP	2203-005482	SA
C300	C-CER,CHIP	2203-000254	SA
C301	C-CER,CHIP	2203-006260	SA
C303	C-CER,CHIP	2203-000679	SA
C304	C-CER,CHIP	2203-000725	SA
C305	C-CER,CHIP	2203-005482	SA
C306	C-CER,CHIP	2203-000438	SA
C307	C-CER,CHIP	2203-005482	SA
C308	C-CER,CHIP	2203-006399	SA
C309	C-CER,CHIP	2203-000679	SA
C310	C-CER,CHIP	2203-005482	SA
C311	C-CER,CHIP	2203-005482	SA
C312	C-CER,CHIP	2203-006208	SA
C313	C-CER,CHIP	2203-005512	SA
C314	C-CER,CHIP	2203-000940	SA
C315	C-CER,CHIP	2203-005480	SA
C317	C-CER,CHIP	2203-000438	SA
C318	C-CER,CHIP	2203-006257	SA
C319	C-CER,CHIP	2203-000233	SA
C320	C-CER,CHIP	2203-005482	SA
C321	C-CER,CHIP	2203-005482	SA
C322	C-CER,CHIP	2203-005482	SA
C323	C-CER,CHIP	2203-005482	SA
C400	C-CER,CHIP	2203-006562	SA
C401	C-CER,CHIP	2203-006361	SA
C402	C-CER,CHIP	2203-006047	SA
C403	C-CER,CHIP	2203-006257	SA
C405	C-CER,CHIP	2203-000254	SA
C406	C-CER,CHIP	2203-005482	SA
C407	C-CER,CHIP	2203-000550	SA
C408	C-CER,CHIP	2203-006257	SA
C409	C-CER,CHIP	2203-000233	SA
C410	C-CER,CHIP	2203-000550	SA
C412	C-CER,CHIP	2203-000254	SA
C414	C-CER,CHIP	2203-006562	SA
C416	C-CER,CHIP	2203-006257	SA

Design LOC	Description	SEC CODE	STATUS
C417	C-CER,CHIP	2203-006257	SA
C418	C-CER,CHIP	2203-000585	SA
C419	C-CER,CHIP	2203-006208	SA
C420	C-CER,CHIP	2203-005482	SA
C423	C-CER,CHIP	2203-006208	SA
C424	C-CER,CHIP	2203-006257	SA
C426	C-CER,CHIP	2203-006208	SA
C500	C-CER,CHIP	2203-000311	SA
C501	C-CER,CHIP	2203-005482	SA
C503	C-CER,CHIP	2203-005482	SA
C504	C-CER,CHIP	2203-000812	SA
C505	C-CER,CHIP	2203-006348	SA
C602	C-CER,CHIP	2203-000278	SA
C603	C-CER,CHIP	2203-001437	SA
C605	C-CER,CHIP	2203-005482	SA
C606	C-CER,CHIP	2203-000854	SA
C609	C-CER,CHIP	2203-000628	SA
C611	C-CER,CHIP	2203-005482	SA
C612	C-CER,CHIP	2203-000278	SA
C614	C-CER,CHIP	2203-005482	SA
C615	C-CER,CHIP	2203-006190	SA
C616	C-CER,CHIP	2203-000278	SA
C617	C-CER,CHIP	2203-000438	SA
C618	C-CER,CHIP	2203-005482	SA
C619	C-CER,CHIP	2203-000278	SA
C621	C-CER,CHIP	2203-005056	SA
C622	C-CER,CHIP	2203-000278	SA
C623	C-CER,CHIP	2203-000254	SA
C624	C-CER,CHIP	2203-006137	SA
C625	C-CER,CHIP	2203-005482	SA
C626	C-CER,CHIP	2203-003054	SA
C627	C-CER,CHIP	2203-003054	SA
C628	C-CER,CHIP	2203-003054	SA
C700	C-CER,CHIP	2203-006562	SA
C701	C-CER,CHIP	2203-006257	SA
C702	C-CER,CHIP	2203-000995	SA
C703	C-CER,CHIP	2203-002443	SA
C704	C-CER,CHIP	2203-005482	SA
C705	C-CER,CHIP	2203-000233	SA
C706	C-CER,CHIP	2203-005482	SA
C707	C-CER,CHIP	2203-005682	SA
C708	C-CER,CHIP	2203-005482	SA
C709	C-CER,CHIP	2203-005682	SA
C710	C-CER,CHIP	2203-006257	SA
C711	C-CER,CHIP	2203-006257	SA

Electrical Parts List

Design LOC	Description	SEC CODE	STATUS
C712	C-CER,CHIP	2203-000254	SA
C714	C-CER,CHIP	2203-005482	SA
C715	C-CER,CHIP	2203-005482	SA
C716	C-CER,CHIP	2203-006257	SA
C717	C-CER,CHIP	2203-005482	SA
C718	C-CER,CHIP	2203-006562	SA
CPL300	BLUETOOTH MODULE	4709-001413	SA
EAR600	JACK-EAR PHONE	3722-002379	SA
F100	DUPLEXER-FEM	2911-000019	SNA
F101	FILTER-EMI SMD	2901-001254	SA
F102	FILTER-SAW	2904-001553	SA
F500	FILTER-EMI/ESD	2901-001322	SA
F501	FILTER-EMI SMD	2901-001283	SA
F502	FILTER-EMI/ESD	2901-001322	SA
F700	FILTER-EMI/ESD	2901-001319	SA
F701	FILTER-EMI/ESD	2901-001319	SA
F702	FILTER-EMI/ESD	2901-001319	SA
F703	FILTER-EMI/ESD	2901-001319	SA
F704	FILTER-EMI/ESD	2901-001353	SA
F705	FILTER-EMI/ESD	2901-001353	SA
F706	FILTER-EMI/ESD	2901-001353	SA
IFC500	CONNECTOR-INTERFACE	3710-001611	SA
L100	INDUCTOR-SMD	2703-002368	SA
L100	INDUCTOR-SMD	2703-002824	SA
L102	INDUCTOR-SMD	2703-002314	SA
L103	INDUCTOR-SMD	2703-001722	SA
L104	INDUCTOR-SMD	2703-002369	SA
L105	INDUCTOR-SMD	2703-002205	SA
L106	INDUCTOR-SMD	2703-002636	SA
L107	INDUCTOR-SMD	2703-002281	SA
L108	INDUCTOR-SMD	2703-002544	SA
L109	INDUCTOR-SMD	2703-002267	SA
L111	BEAD-SMD	3301-001729	SA
L112	BEAD-SMD	3301-001659	SA
L114	INDUCTOR-SMD	2703-002203	SA
L302	INDUCTOR-SMD	2703-001752	SA
L303	INDUCTOR-SMD	2703-002176	SA
L400	BEAD-SMD	3301-001120	SA
L401	INDUCTOR-SMD	2703-002653	SA
L600	BEAD-SMD	3301-001438	SA
L601	BEAD-SMD	3301-001438	SA
L613	INDUCTOR-SMD	2703-001513	SA
L614	INDUCTOR-SMD	2703-001513	SA
L615	INDUCTOR-SMD	2703-001513	SA
L700	BEAD-SMD	3301-001729	SA

Design LOC	Description	SEC CODE	STATUS
L701	BEAD-SMD	3301-001729	SA
LED700	LED	0601-002055	SA
LED701	LED	0601-002055	SA
LED702	LED	0601-002055	SA
LED703	LED	0601-002055	SA
LED704	LED	0601-002055	SA
LED705	LED	0601-002055	SA
LED706	LED	0601-002055	SA
LED707	LED	0601-002055	SA
LED800	LED	0601-002055	SA
LED801	LED	0601-002055	SA
LED802	LED	0601-002055	SA
LED803	LED	0601-002055	SA
LED804	LED	0601-002015	SA
OSC400	CRYSTAL-SMD	2801-004466	SA
PAM100	IC-POWER AMP	1201-002254	SA
R100	R-CHIP	2007-000162	SA
R101	R-CHIP	2007-000171	SA
R102	R-CHIP	2007-000137	SA
R103	R-CHIP	2007-000172	SA
R104	R-CHIP	2007-000172	SA
R105	R-CHIP	2007-000171	SA
R105	R-CHIP	2007-007009	SA
R106	R-CHIP	2007-000148	SA
R106	R-CHIP	2007-007009	SA
R107	R-CHIP	2007-000173	SA
R107	R-CHIP	2007-000566	SA
R108	R-CHIP	2007-000172	SA
R108	R-CHIP	2007-000173	SA
R109	R-CHIP	2007-000566	SA
R110	R-CHIP	2007-001288	SA
R111	R-CHIP	2007-000152	SA
R111	R-CHIP	2007-001313	SNA
R112	R-CHIP	2007-000162	SA
R112	R-CHIP	2007-001313	SNA
R116	R-CHIP	2007-000172	SA
R117	R-CHIP	2007-000932	SA
R118	R-CHIP	2007-000932	SA
R119	R-CHIP	2007-000140	SA
R120	R-CHIP	2007-000171	SA
R121	R-CHIP	2007-000171	SA
R122	R-CHIP	2007-000171	SA
R123	R-CHIP	2007-000171	SA
R124	R-CHIP	2007-000171	SA
R125	R-CHIP	2007-001317	SA

Electrical Parts List

Design LOC	Description	SEC CODE	STATUS
R200	R-CHIP	2007-000148	SA
R201	R-CHIP	2007-000171	SA
R202	R-CHIP	2007-007001	SA
R203	R-CHIP	2007-000242	SA
R204	R-CHIP	2007-000242	SA
R205	R-CHIP	2007-000162	SA
R206	R-CHIP	2007-000162	SA
R207	R-CHIP	2007-000162	SA
R208	R-CHIP	2007-000162	SA
R209	R-CHIP	2007-000143	SA
R211	R-CHIP	2007-000148	SA
R300	R-CHIP	2007-000171	SA
R301	R-CHIP	2007-000171	SA
R302	R-CHIP	2007-001325	SA
R303	R-CHIP	2007-000148	SA
R304	R-CHIP	2007-007101	SA
R305	R-CHIP	2007-000151	SA
R306	R-CHIP	2007-000162	SA
R307	R-CHIP	2007-000141	SA
R308	R-CHIP	2007-000141	SA
R309	R-CHIP	2007-000148	SA
R310	R-CHIP	2007-000162	SA
R313	R-CHIP	2007-000171	SA
R314	R-CHIP	2007-007014	SA
R315	R-CHIP	2007-001303	SA
R316	R-CHIP	2007-007014	SA
R317	R-CHIP	2007-001303	SA
R401	R-CHIP	2007-007100	SA
R405	R-CHIP	2007-000162	SA
R408	R-CHIP	2007-001316	SA
R500	R-CHIP	2007-000162	SA
R501	R-CHIP	2007-000758	SA
R502	R-CHIP	2007-000758	SA
R504	R-CHIP	2007-000170	SA
R505	R-CHIP	2007-000170	SA
R506	R-CHIP	2007-000138	SA
R507	R-CHIP	2007-000138	SA
R508	R-CHIP	2007-007107	SA
R509	R-CHIP	2007-000148	SA
R510	R-CHIP	2007-000152	SA
R511	R-CHIP	2007-000137	SA
R512	R-CHIP	2007-007573	SA
R513	R-CHIP	2007-007334	SA
R514	R-CHIP	2007-007875	SA
R515	R-CHIP	2007-007489	SA

Design LOC	Description	SEC CODE	STATUS
R516	R-CHIP	2007-000156	SA
R602	R-CHIP	2007-000137	SA
R604	R-CHIP	2007-000137	SA
R605	R-CHIP	2007-001316	SA
R606	R-CHIP	2007-000831	SA
R607	R-CHIP	2007-000162	SA
R608	R-CHIP	2007-000162	SA
R609	R-CHIP	2007-000162	SA
R610	R-CHIP	2007-007573	SA
R611	R-CHIP	2007-007480	SA
R612	R-CHIP	2007-000138	SA
R700	R-CHIP	2007-000162	SA
R701	R-CHIP	2007-007009	SA
R702	R-CHIP	2007-007009	SA
R703	R-CHIP	2007-007009	SA
R704	R-CHIP	2007-007009	SA
R705	R-CHIP	2007-007009	SA
R706	R-CHIP	2007-007009	SA
R707	R-CHIP	2007-007009	SA
R708	R-CHIP	2007-007009	SA
R709	R-CHIP	2007-000162	SA
R710	R-CHIP	2007-000162	SA
R711	R-CHIP	2007-000162	SA
R712	R-CHIP	2007-007013	SA
RFS100	CONNECTOR-COAXIAL	3705-001358	SA
SIM400	CONNECTOR-CARD EDGE	3709-001355	SA
SLC100	CONNECTOR-FPC/FFC/PIC	3708-002170	SA
SLC101	CONNECTOR-FPC/FFC/PIC	3708-002162	SA
SLC102	CONNECTOR-FPC/FFC/PIC	3708-002222	SA
SLC700	CONNECTOR-FPC/FFC/PIC	3708-002170	SA
TA122	C-TA,CHIP	2404-001413	SA
TA404	C-TA,CHIP	2404-001381	SA
TA411	C-TA,CHIP	2404-001381	SA
TA413	C-TA,CHIP	2404-001225	SA
TA415	C-TA,CHIP	2404-001225	SA
TA425	C-TA,CHIP	2404-001225	SA
TA502	C-TA,CHIP	2404-001268	SA
TA601	C-TA,CHIP	2404-001377	SA
TCX100	OSCILLATOR-VCTCXO	2809-001287	SA
TR500	TR-DIGITAL	0504-001151	SA
U100	IC-PWM CONTROLLER	1203-003443	SA
U101	IC-TRANSCEIVER	1205-002817	SA
U102	IC-POSI.FIXED REG.	1203-003754	SA
U103	IC-DC/DC CONVERTER	1203-003978	SA
U200	IC-CMOS LOGIC	0801-003031	SA

Electrical Parts List

Design LOC	Description	SEC CODE	STATUS
U301	IC-MELODY	1204-002161	SA
U302	IC-CMOS LOGIC	0801-003022	SA
U303	IC ASIC	GH13-00032A	SA
U304	IC-CMOS LOGIC	0801-002958	SA
U305	IC-CMOS LOGIC	0801-003031	SA
U400	IC-POSI.FIXED REG.	1203-003754	SA
U401	IC-DC/DC CONVERTER	1203-003545	SA
U402	IC-POWER SUPERVISOR	1203-003882	SA
U500	IC-BATTERY	1203-003742	SA
U600	IC-ANALOG SWITCH	1001-001336	SA
U601	IC-ANALOG SWITCH	1001-001336	SA
U602	IC-ANALOG SWITCH	1001-001336	SA
U603	IC-VOLTAGE COMP.	1202-001068	SA
U608	IC-ANALOG MULTIPLEX	1001-001306	SA
U700	IC-POSI.FIXED REG.	1203-003754	SA
U701	IC-CMOS LOGIC	0801-002970	SA
U702	IC-HALL EFFECT S/W	1009-001020	SA
U703	IC-POSI.FIXED REG.	1203-003432	SA
UCP201	IC-COMM. CONTROLLER	1205-002670	SA
UME300	IC-MCP	1108-000018	SA
VR100	VARISTOR	1405-001082	SA
VR101	VARISTOR	1405-001082	SA
VR101	VARISTOR	1405-001082	SA
VR102	VARISTOR	1405-001128	SA
VR103	VARISTOR	1405-001128	SA
VR104	VARISTOR	1405-001128	SA
VR105	VARISTOR	1405-001128	SA
VR106	VARISTOR	1405-001128	SA
VR107	VARISTOR	1405-001128	SA
VR501	THERMISTOR-NTC	1404-001221	SA
VR600	VARISTOR	1405-001082	SA
VR601	VARISTOR	1405-001082	SA
ZD500	DIODE-ZENER	0403-001427	SA
ZD501	DIODE-TVS	0406-001201	SA
ZD502	DIODE-ZENER	0403-001547	SA
ZD600	DIODE-TVS	0406-001201	SA
ZD601	DIODE-TVS	0406-001201	SA
ZD602	DIODE-TVS	0406-001194	SA
ZD603	DIODE-TVS	0406-001194	SA
ZD700	DIODE-TVS	0406-001201	SA
ZD701	DIODE-TVS	0406-001201	SA
ZD702	DIODE-TVS	0406-001201	SA
ZD703	DIODE-TVS	0406-001201	SA
ZD704	DIODE-TVS	0406-001201	SA
ZD705	DIODE-TVS	0406-001194	SA

7. Block Diagrams

7-1. RF Solution Block Diagram

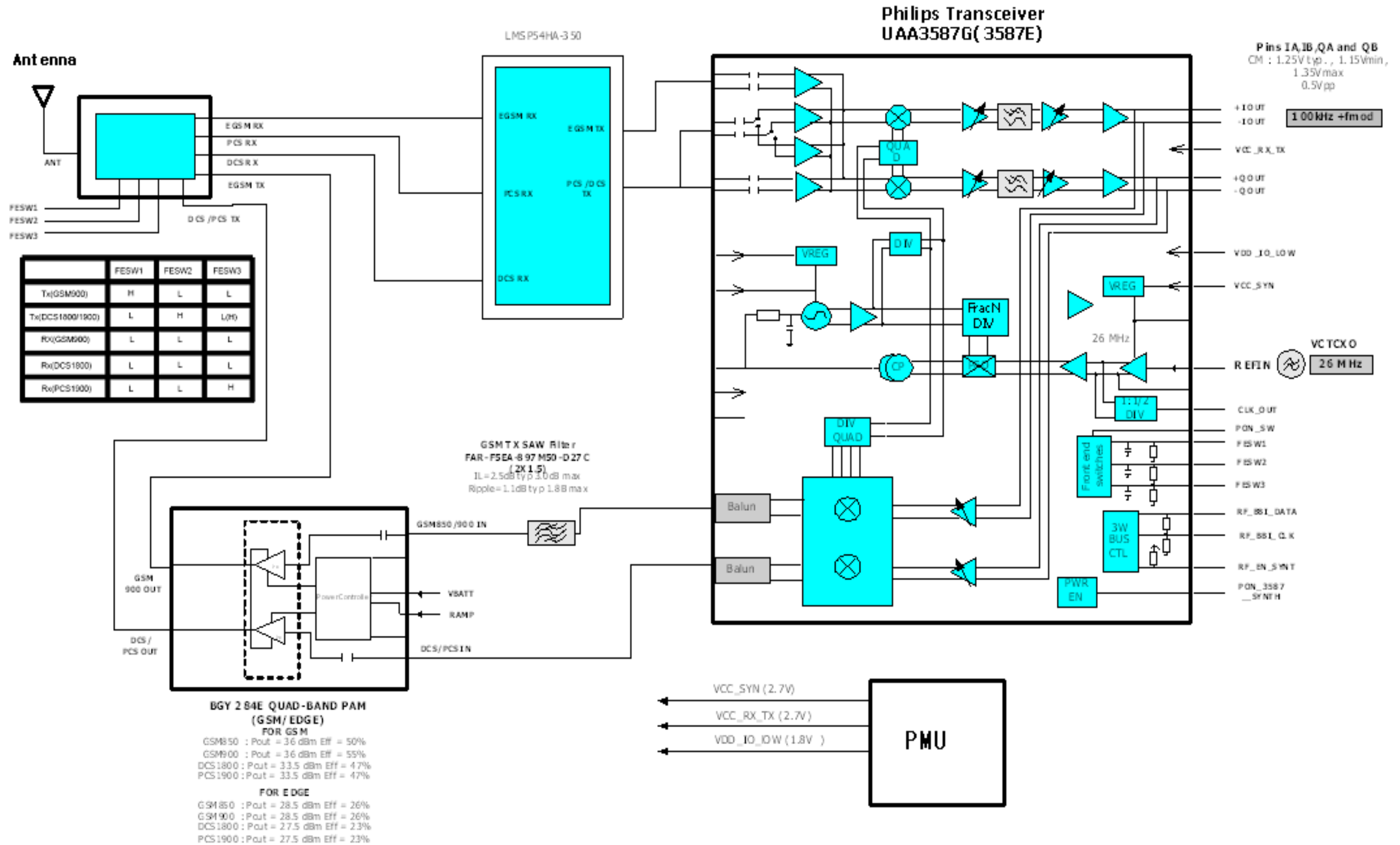

7-2. Base Band Solution Block Diagram

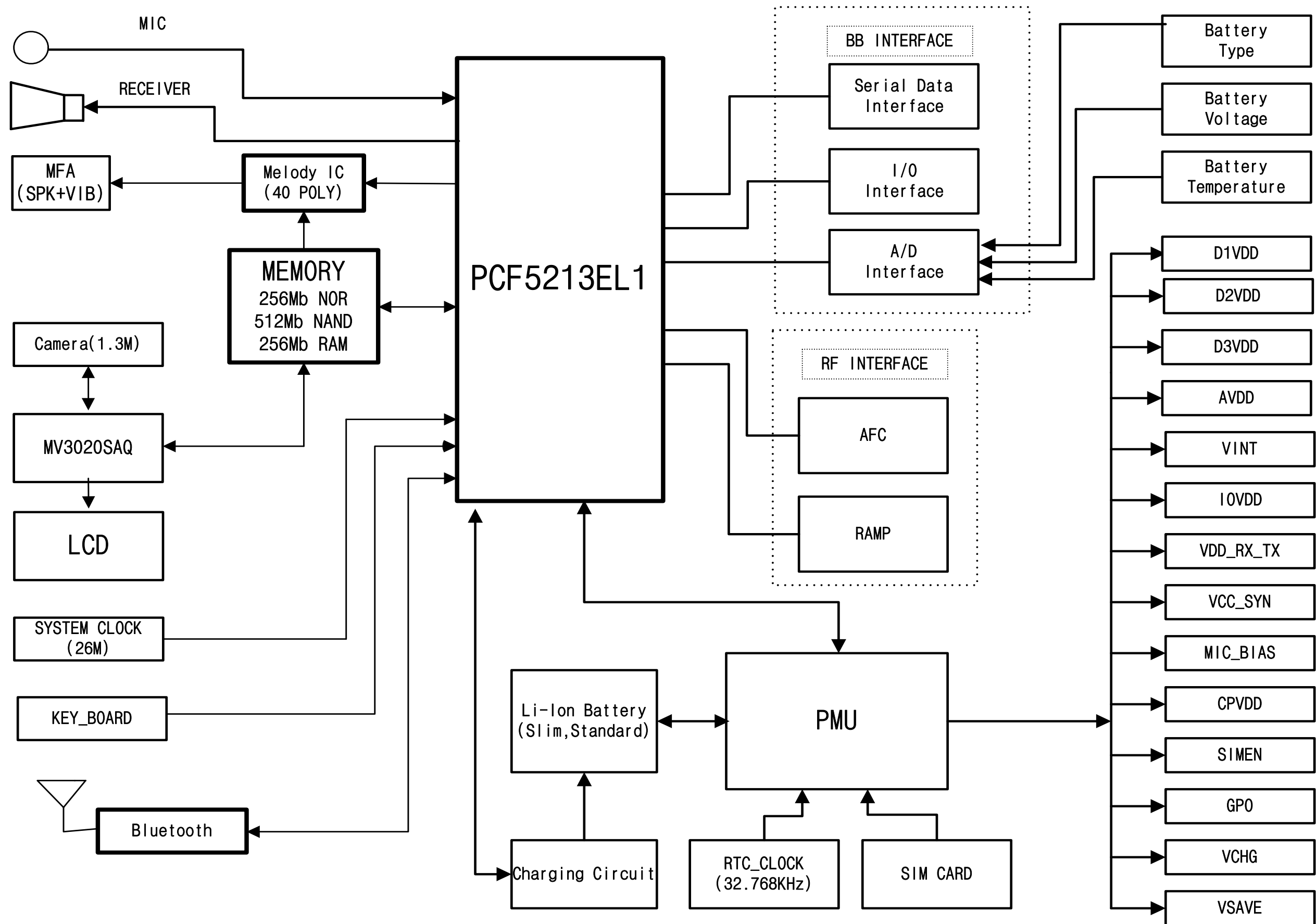

8. PCB Diagrams

8-1. Main PCB Diagram

Top

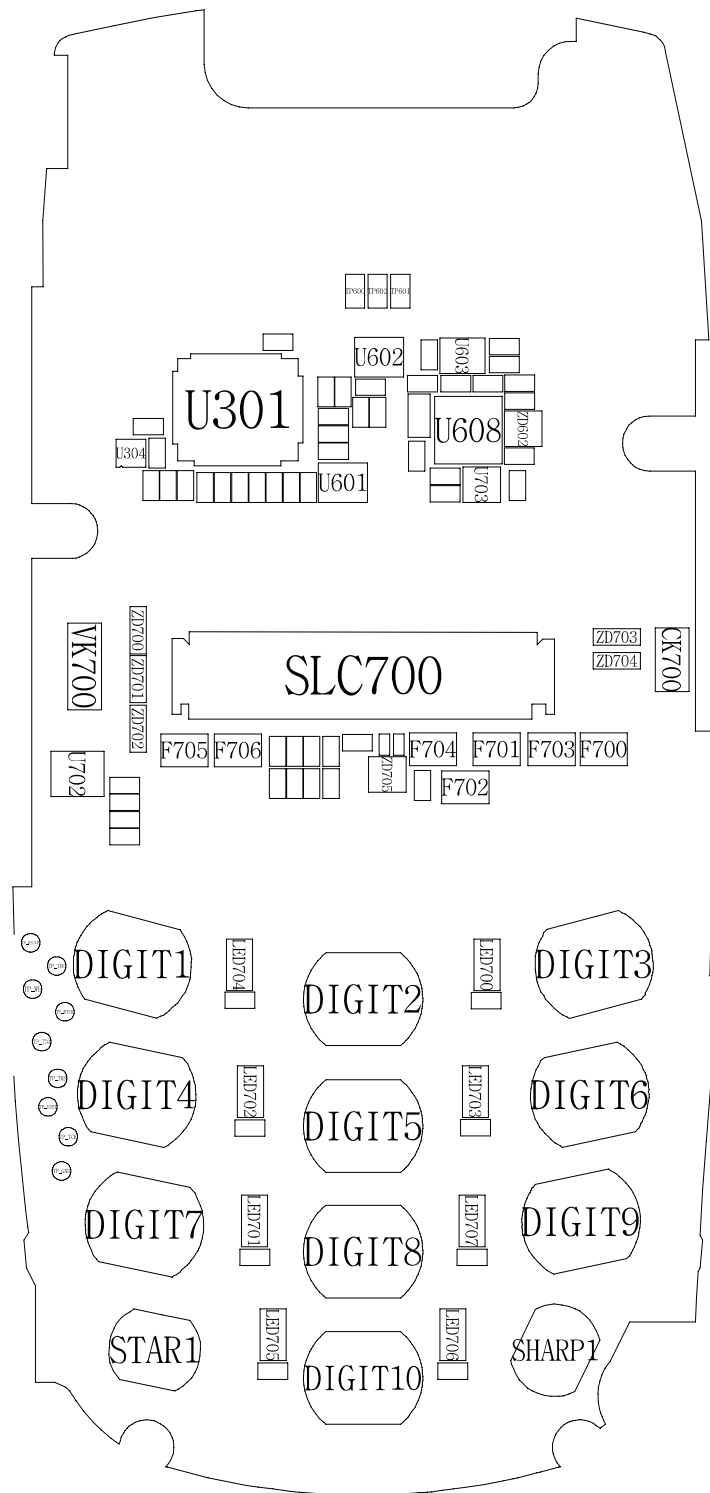

Bottom

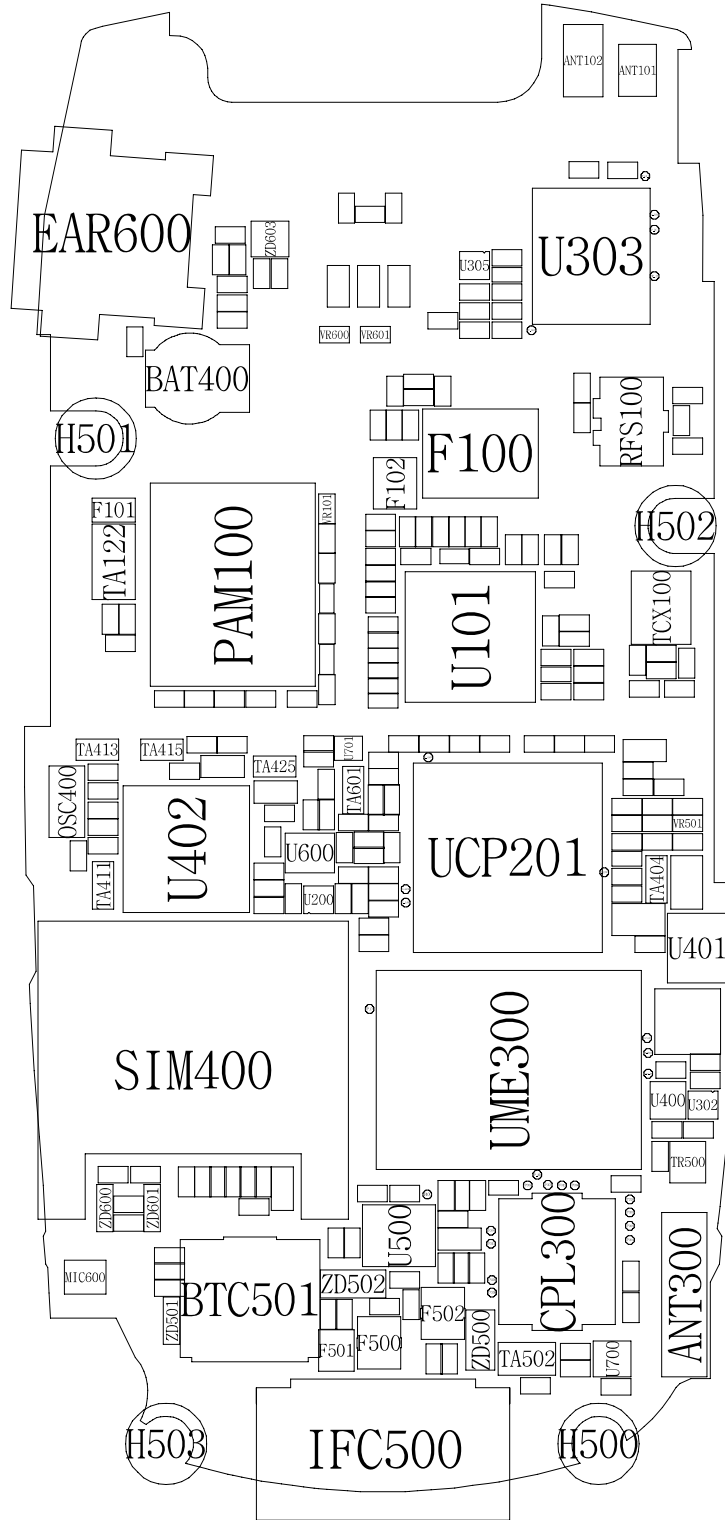

8-2. Sub PCB Diagram

Top

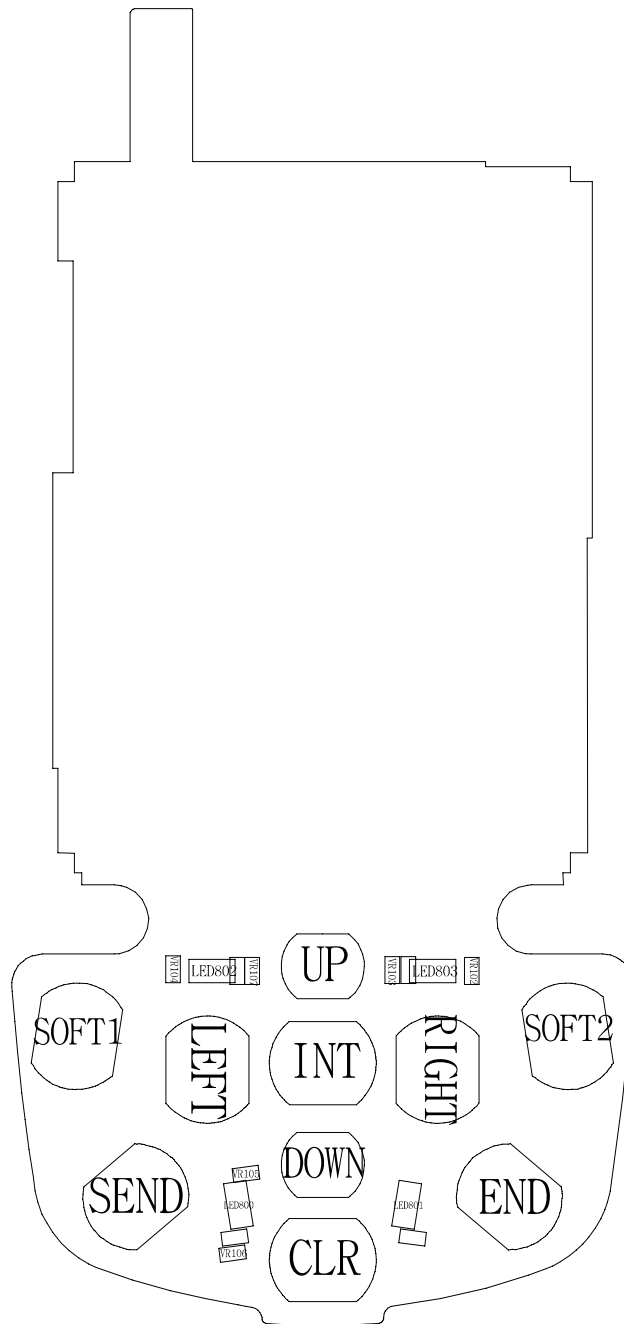

L101

Bottom

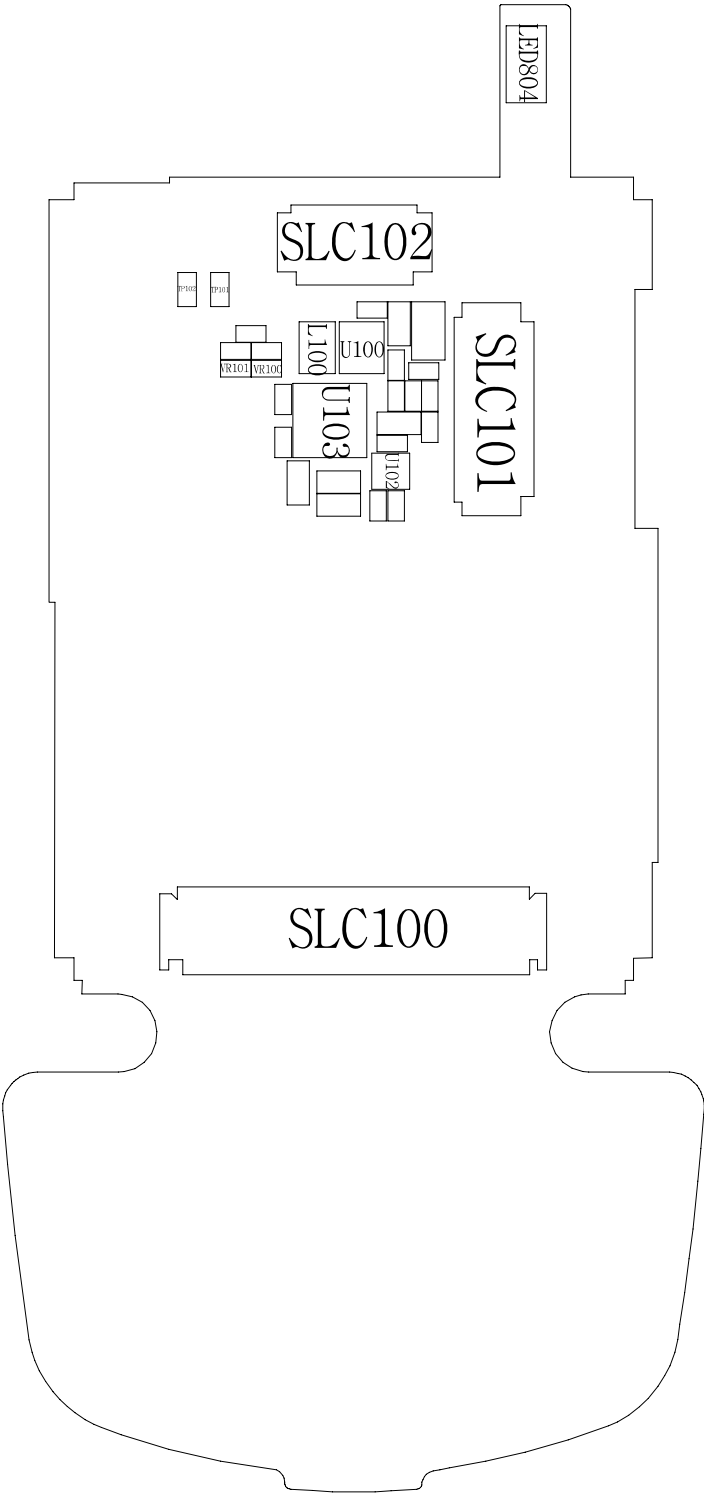

9. Flow Chart of Troubleshooting

9-1. Power On

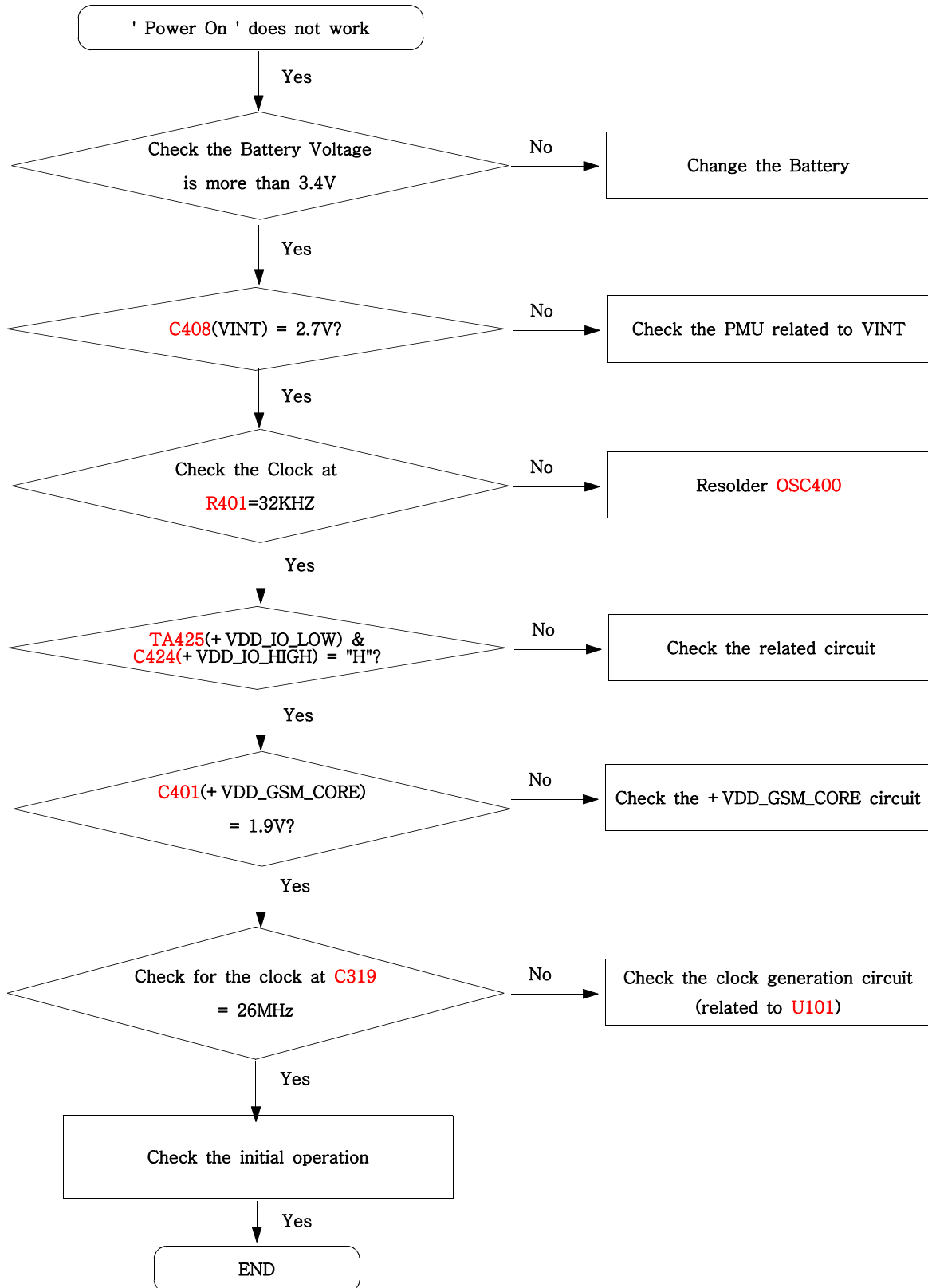

Flow Chart of Troubleshooting

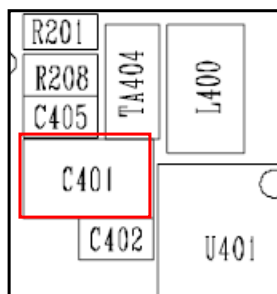
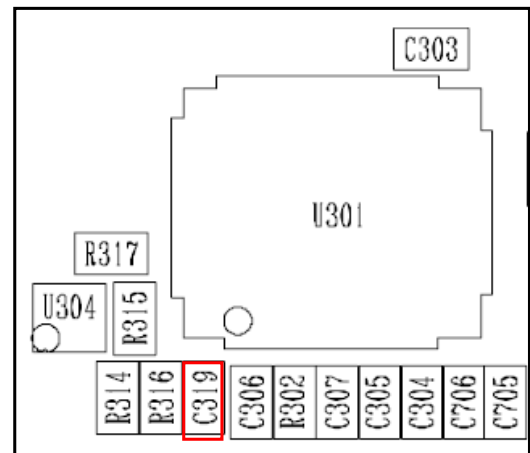
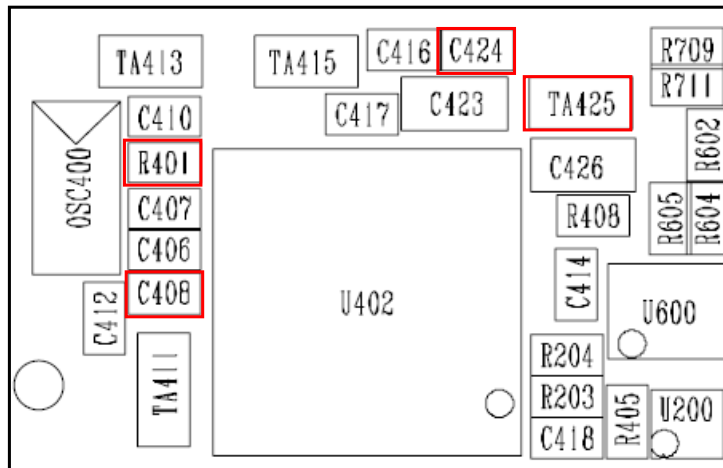
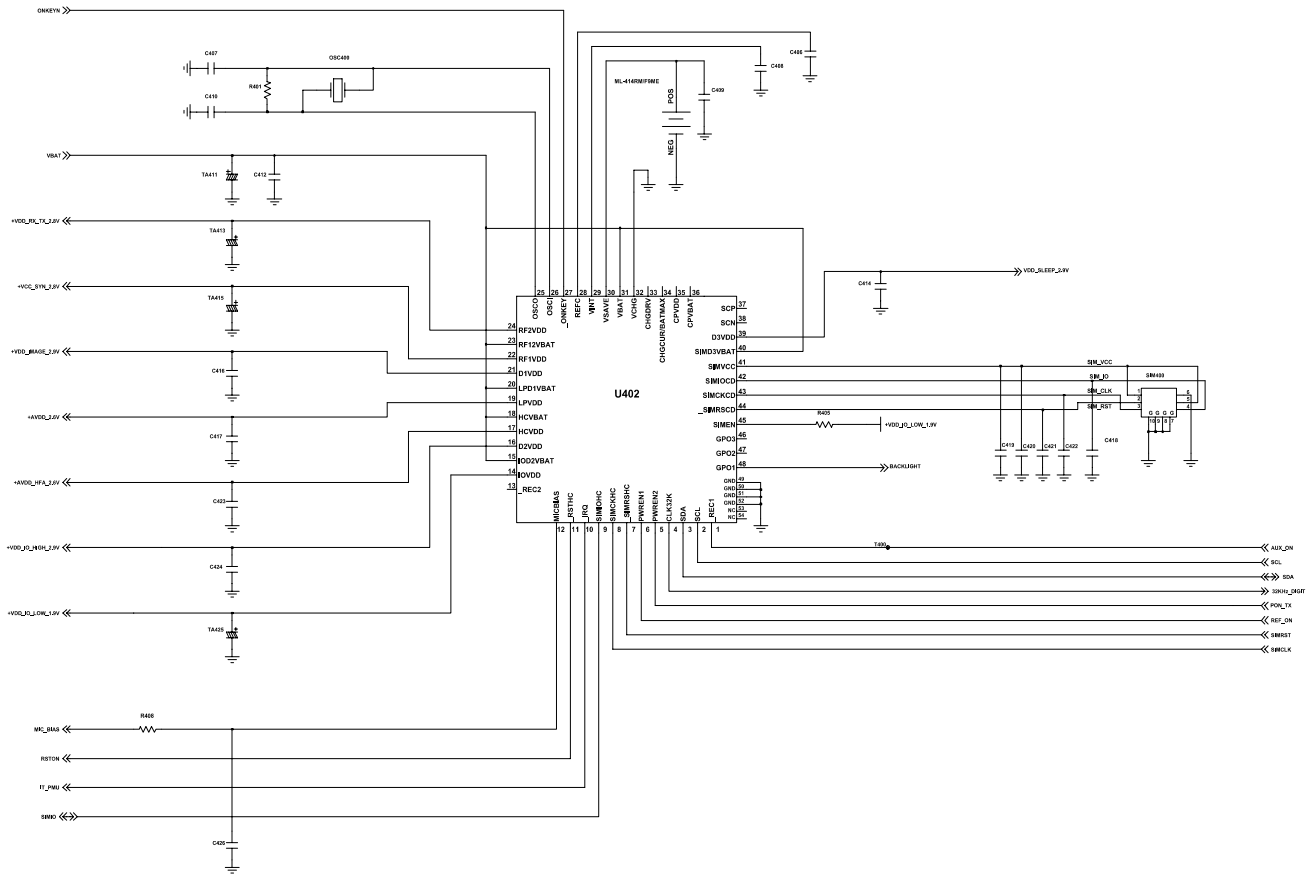

9-2. Initial

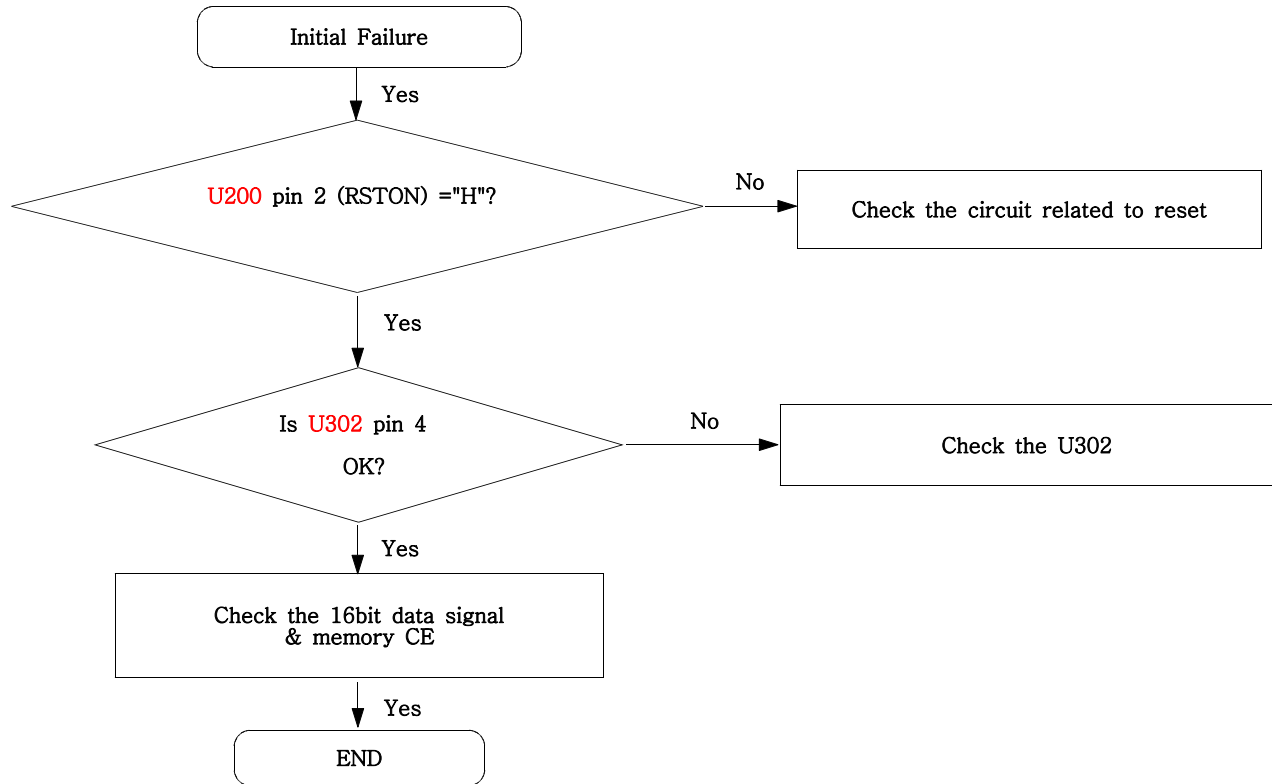

Flow Chart of Troubleshooting

UME300

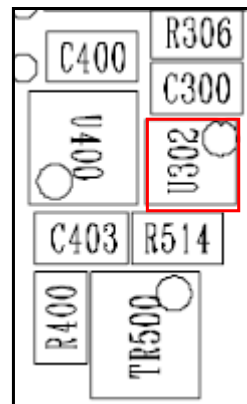
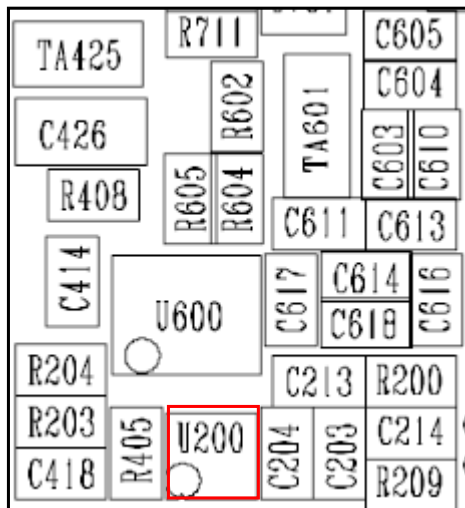
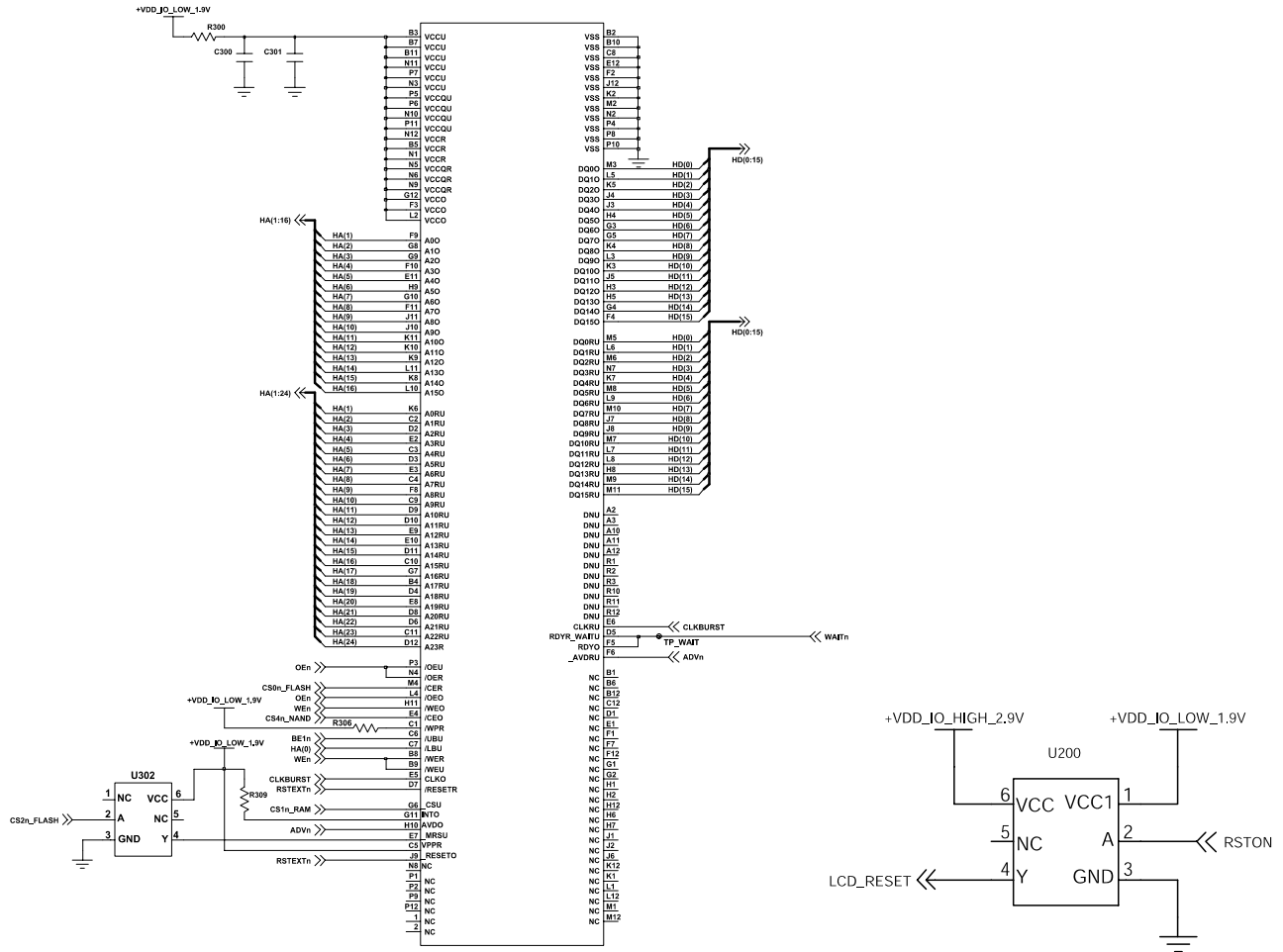

9-3. Charging Part

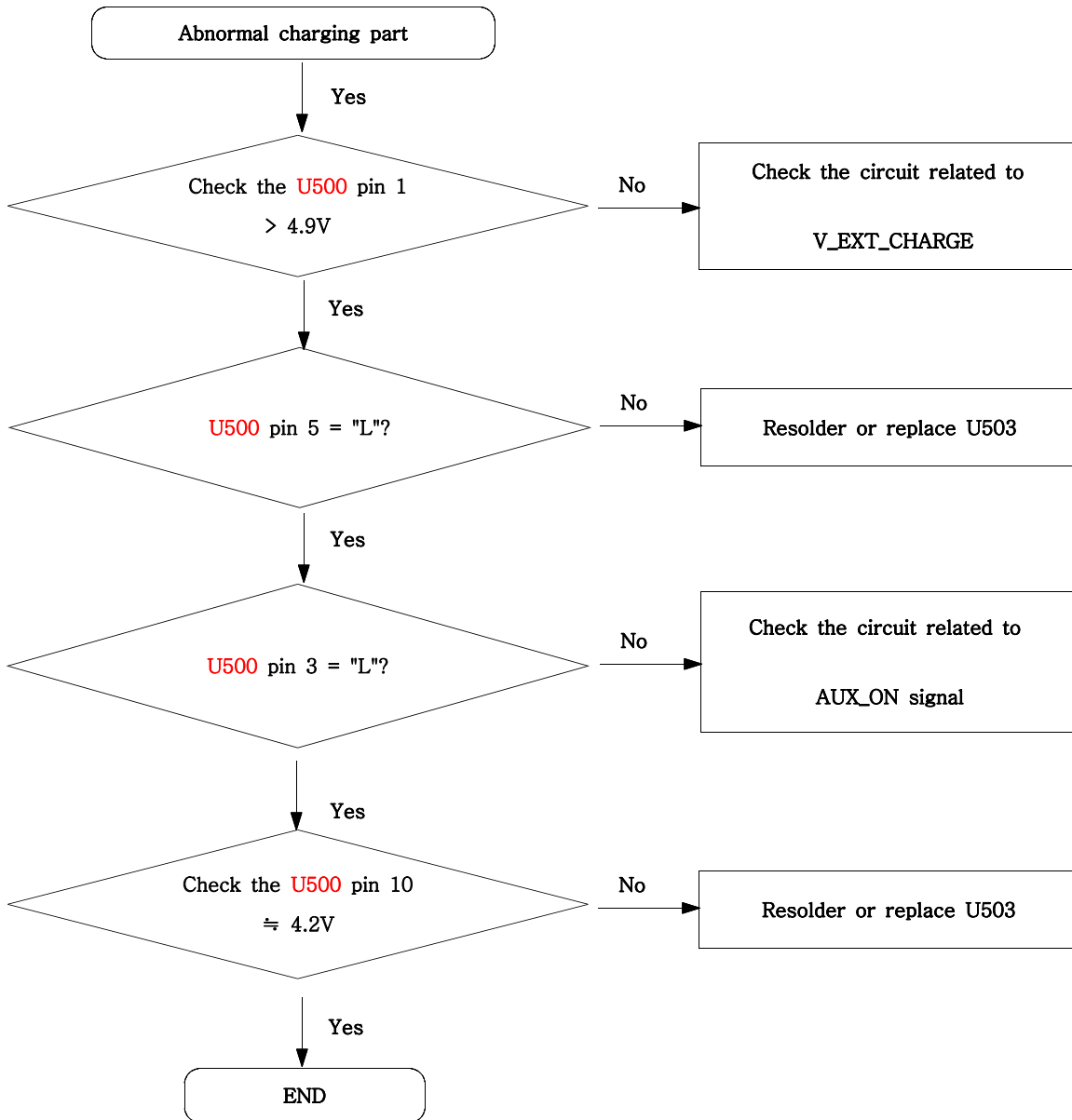

Flow Chart of Troubleshooting

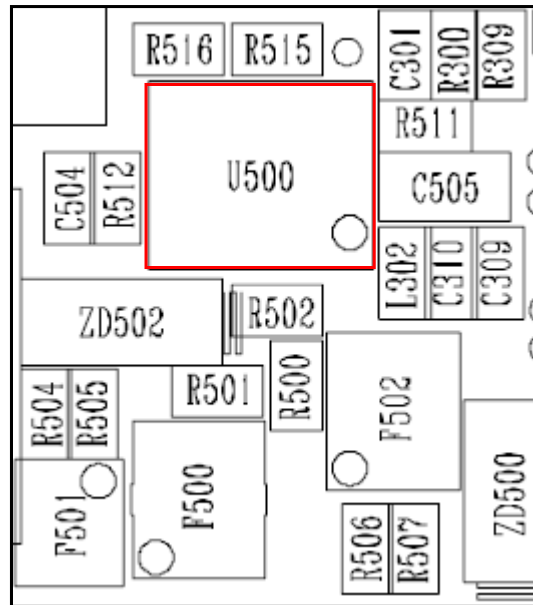
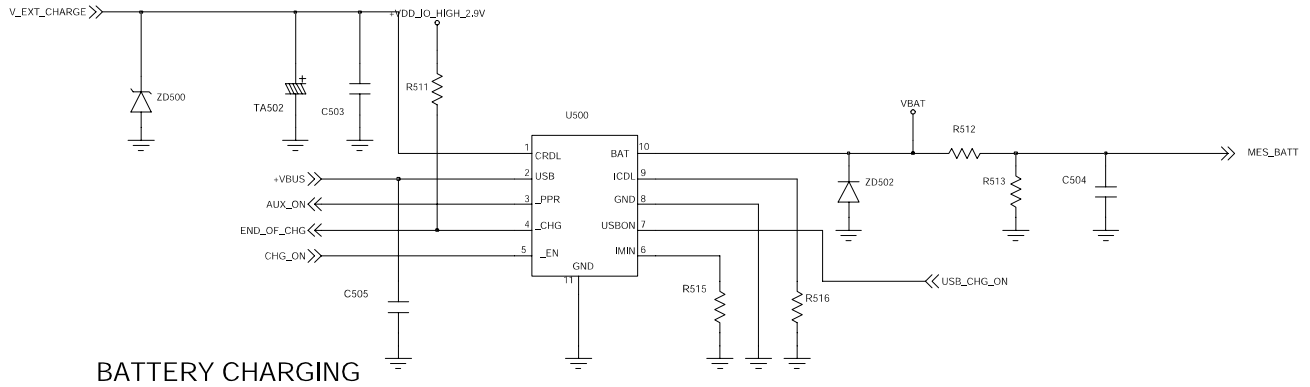

9-4. Sim Part

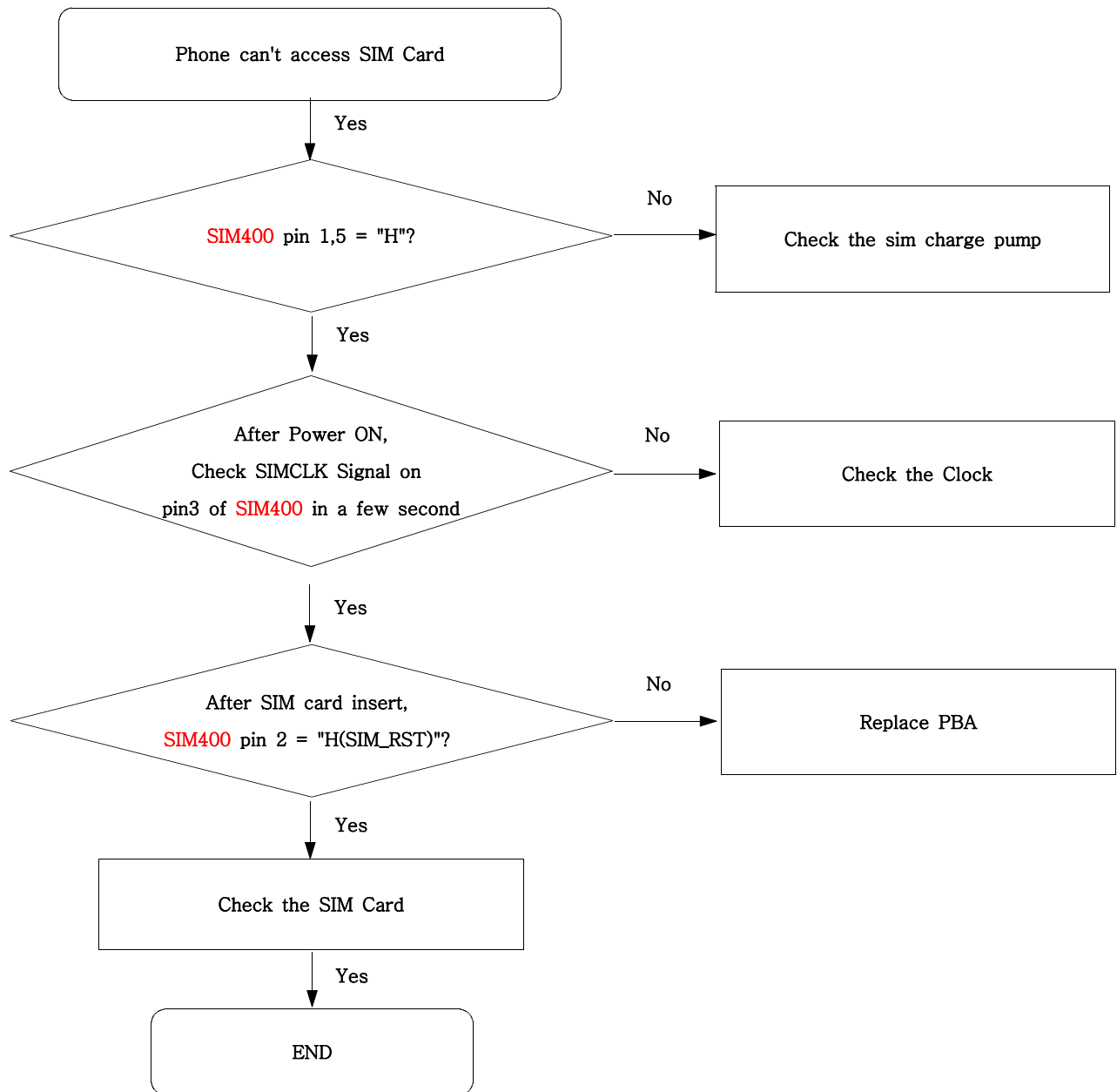

Flow Chart of Troubleshooting

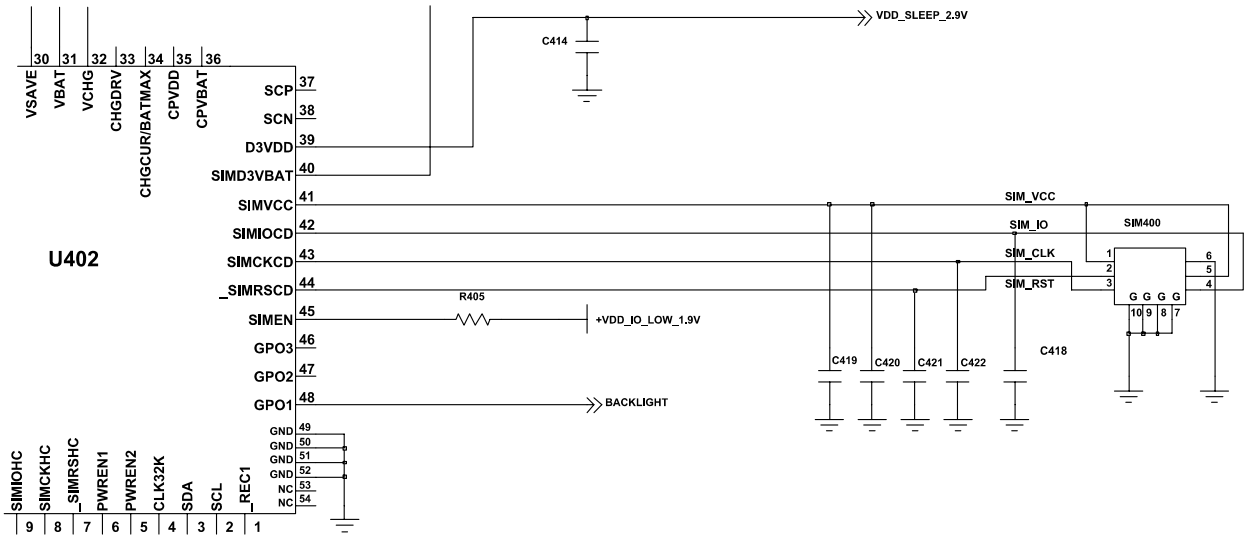

9-5. Microphone Part

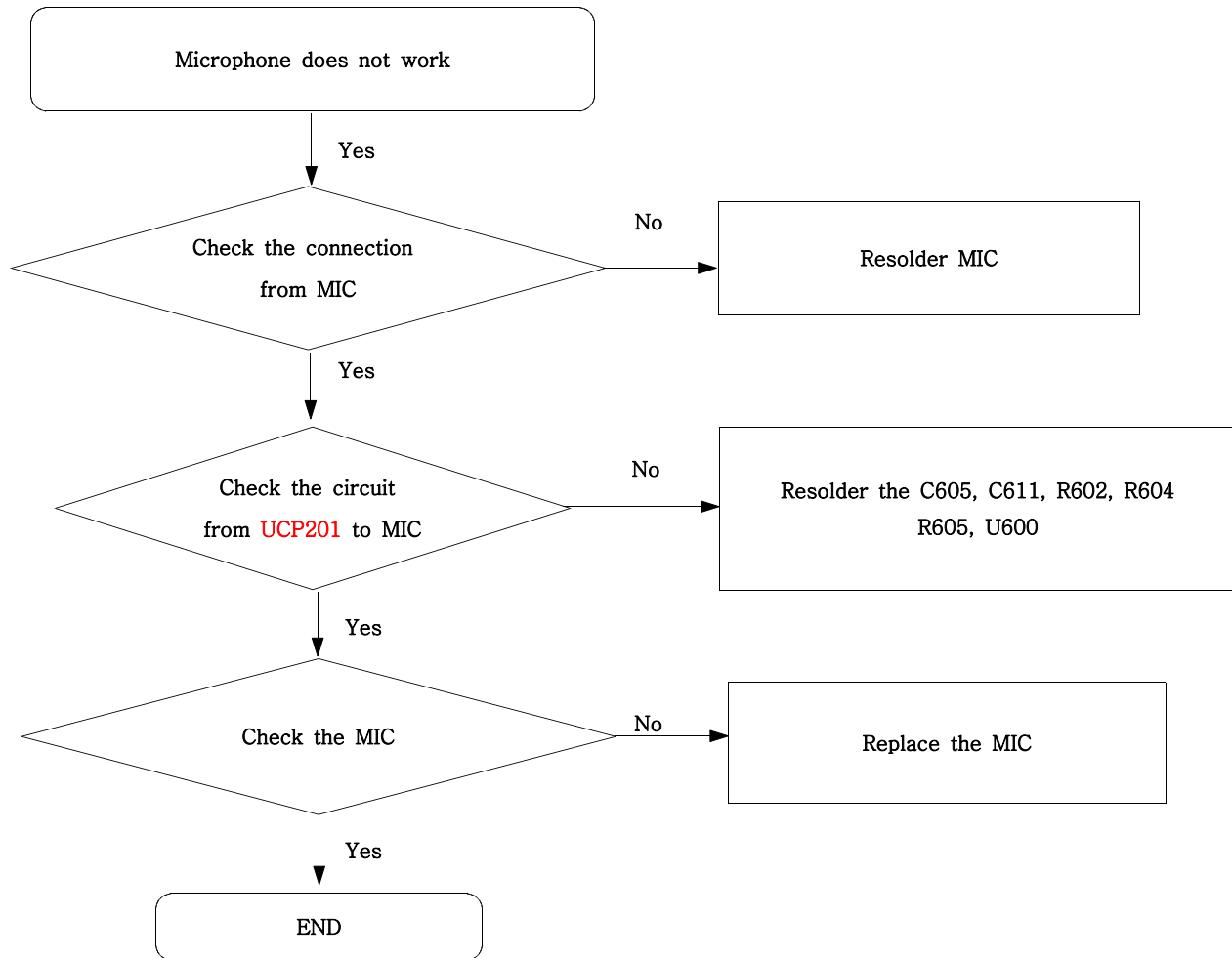

Flow Chart of Troubleshooting

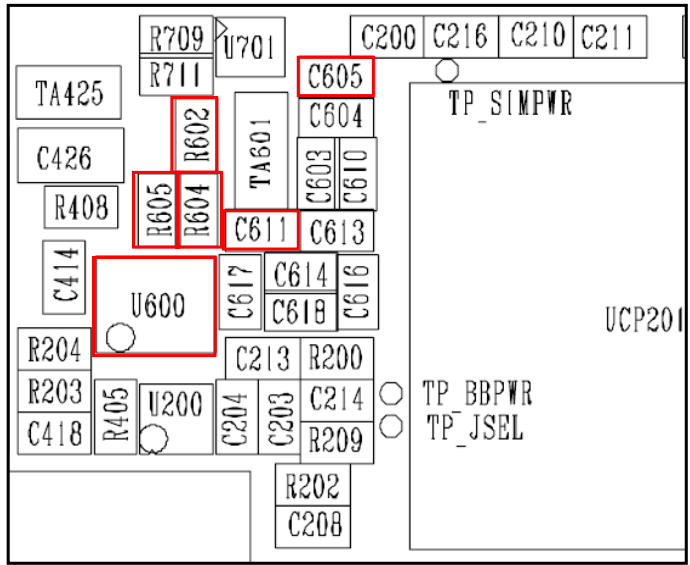
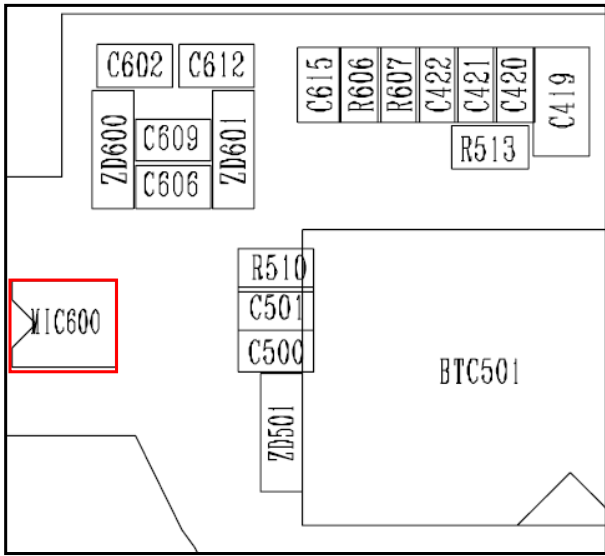
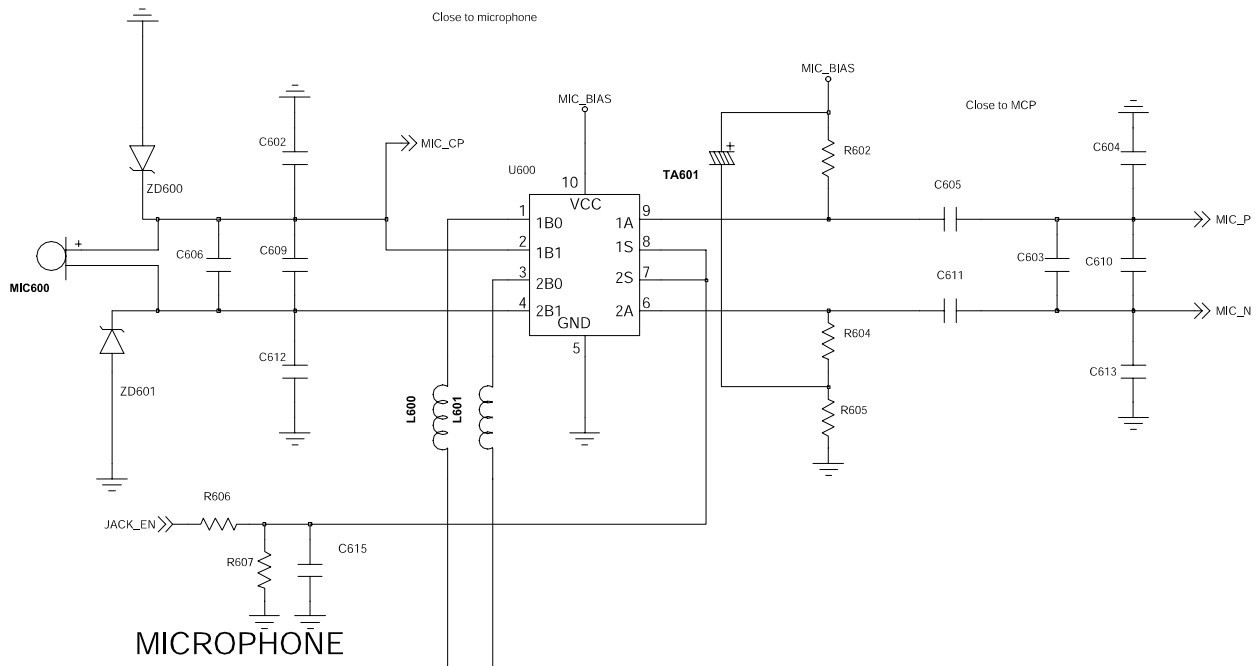

9-6. Speaker Part(Melody)

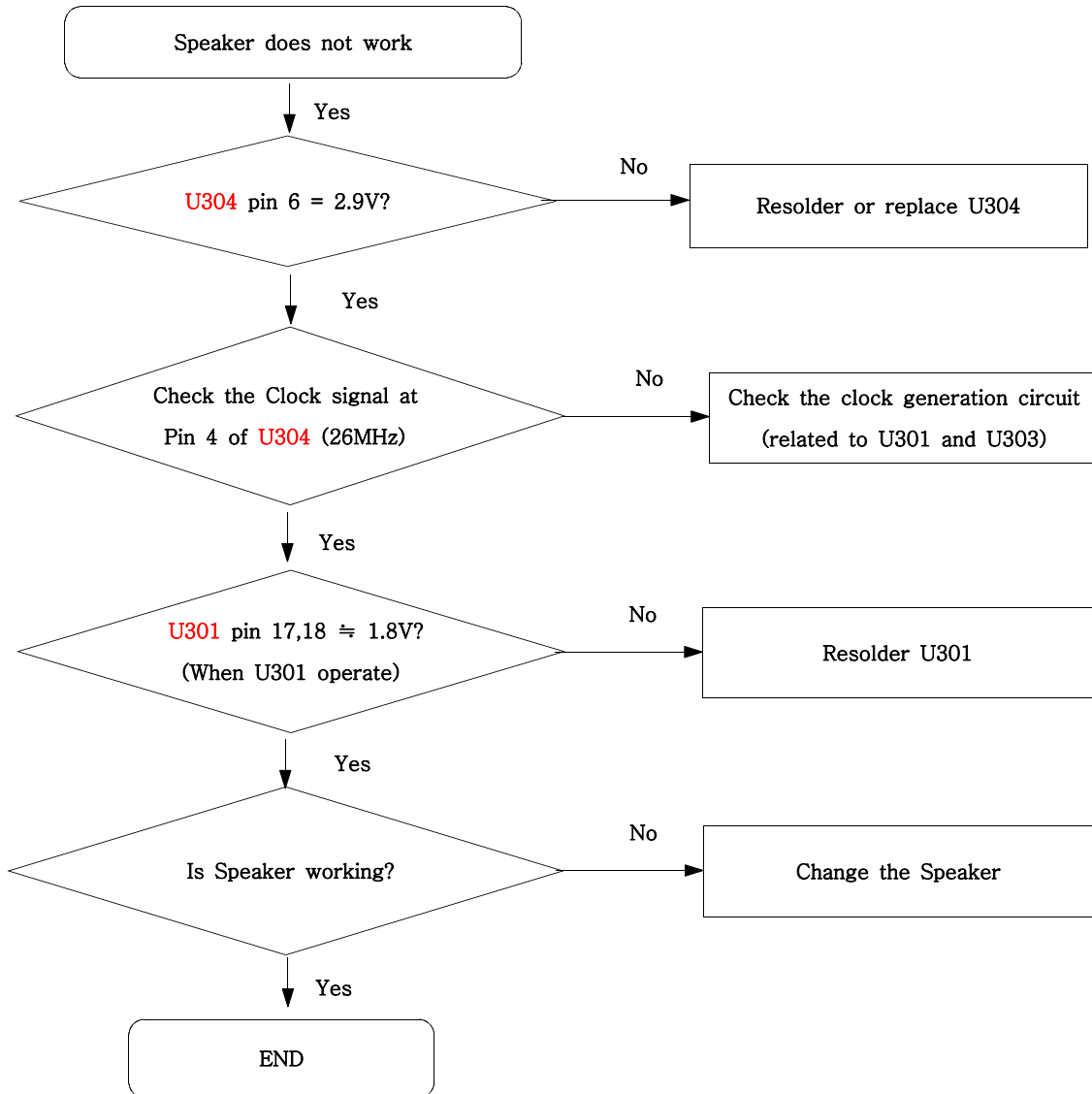

Flow Chart of Troubleshooting

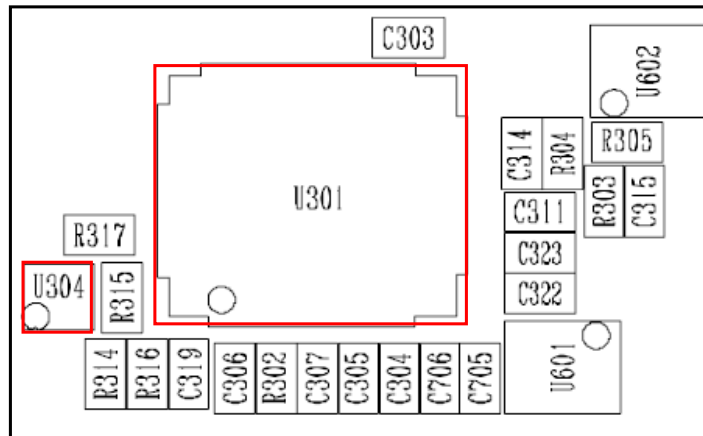
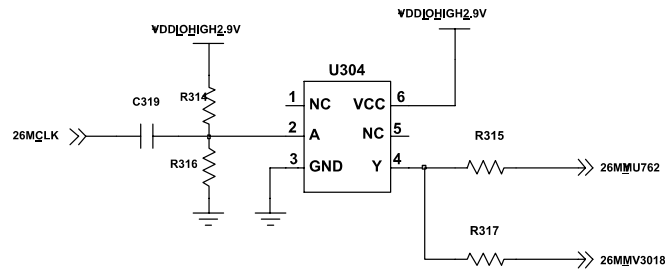
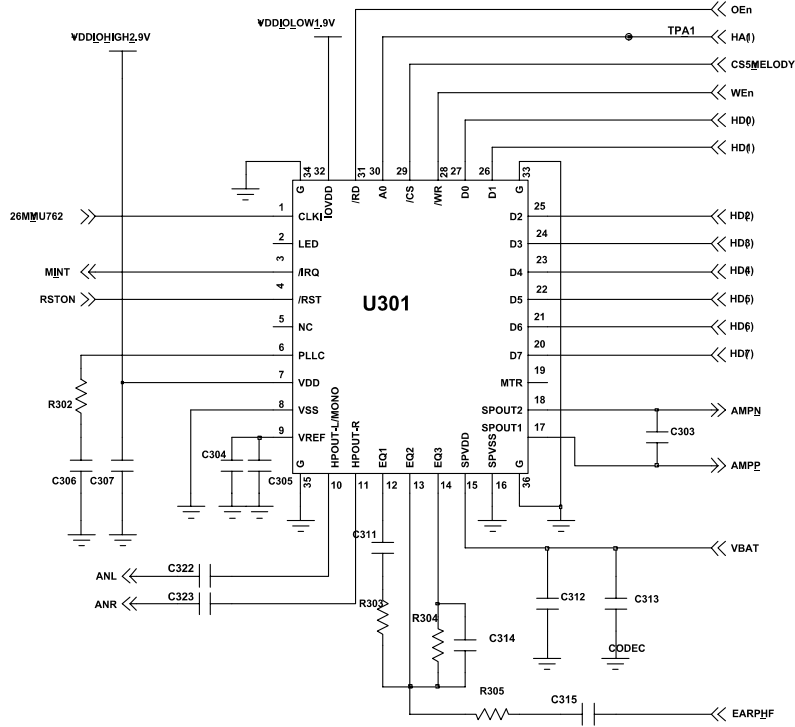

9-7. Key Data Input

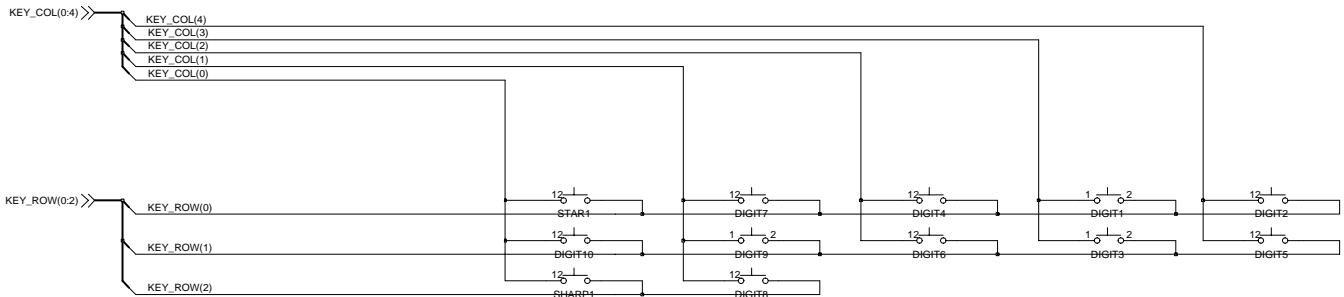
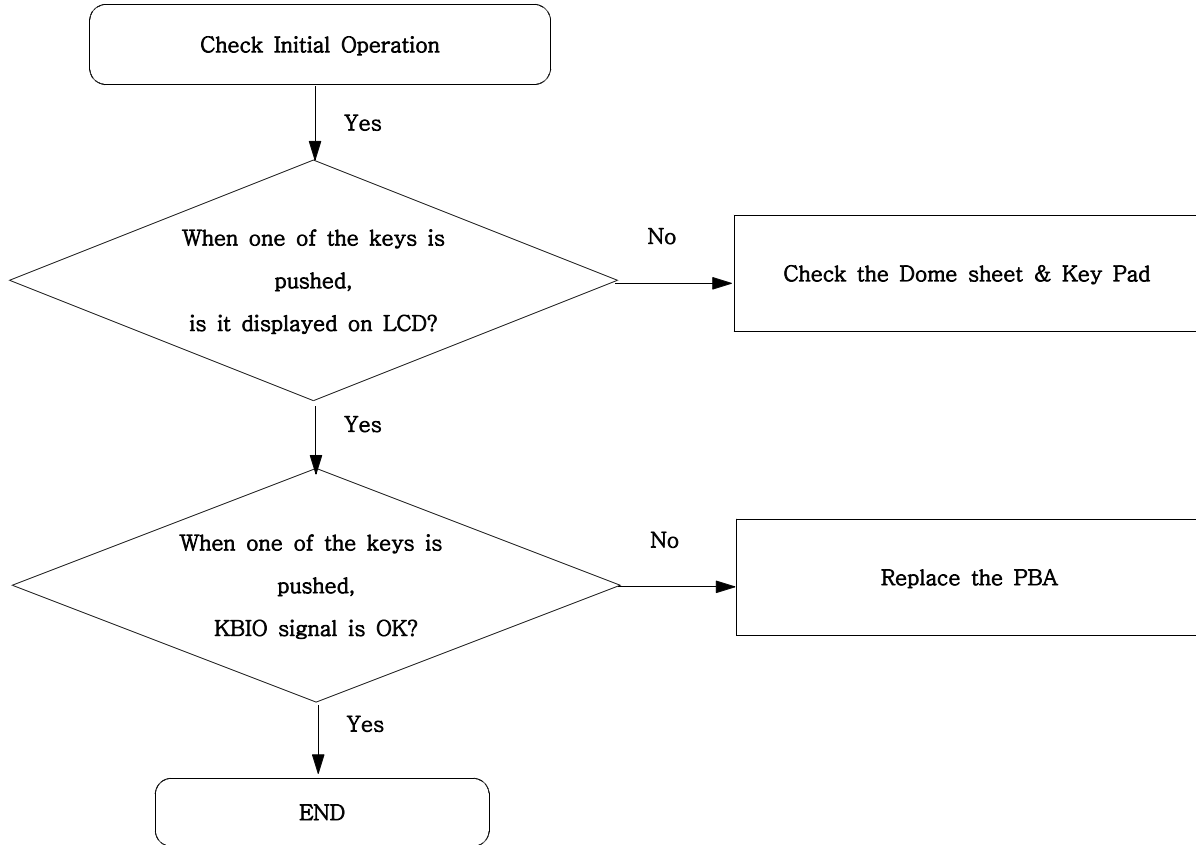

KEY_MAP

9-8. Receiver Part

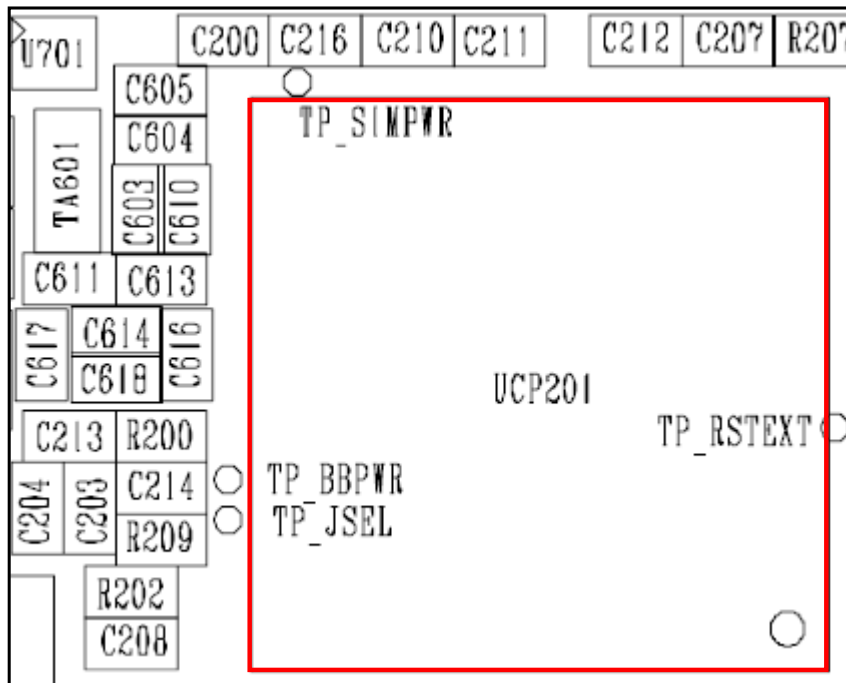
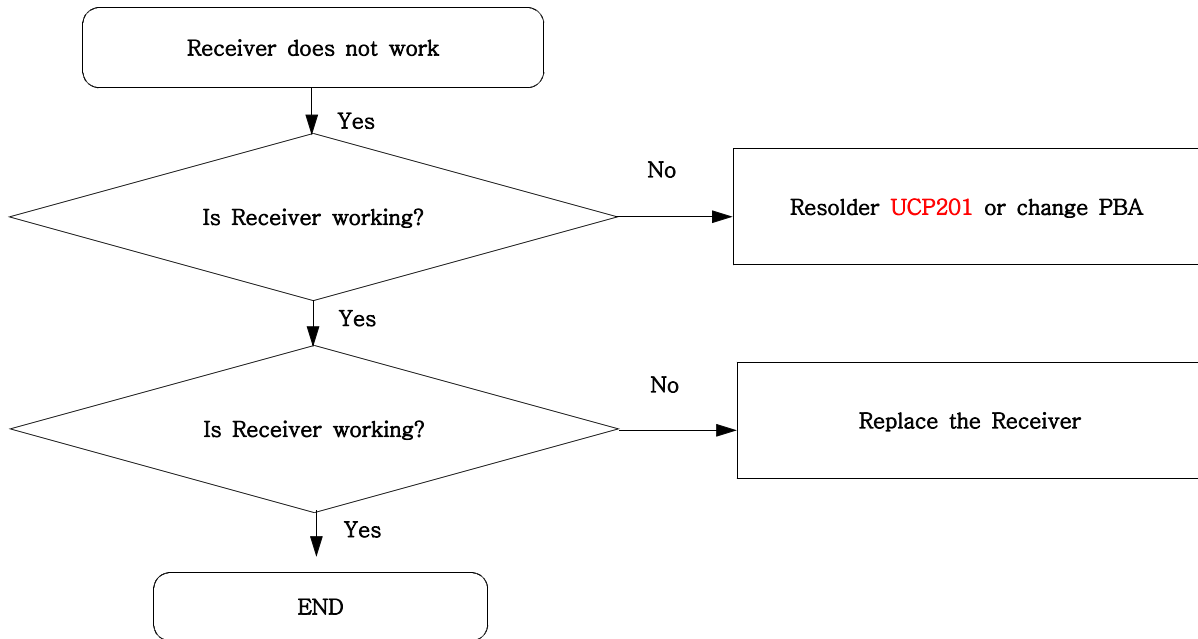

9-9. Back Light (for Color Main LCD)

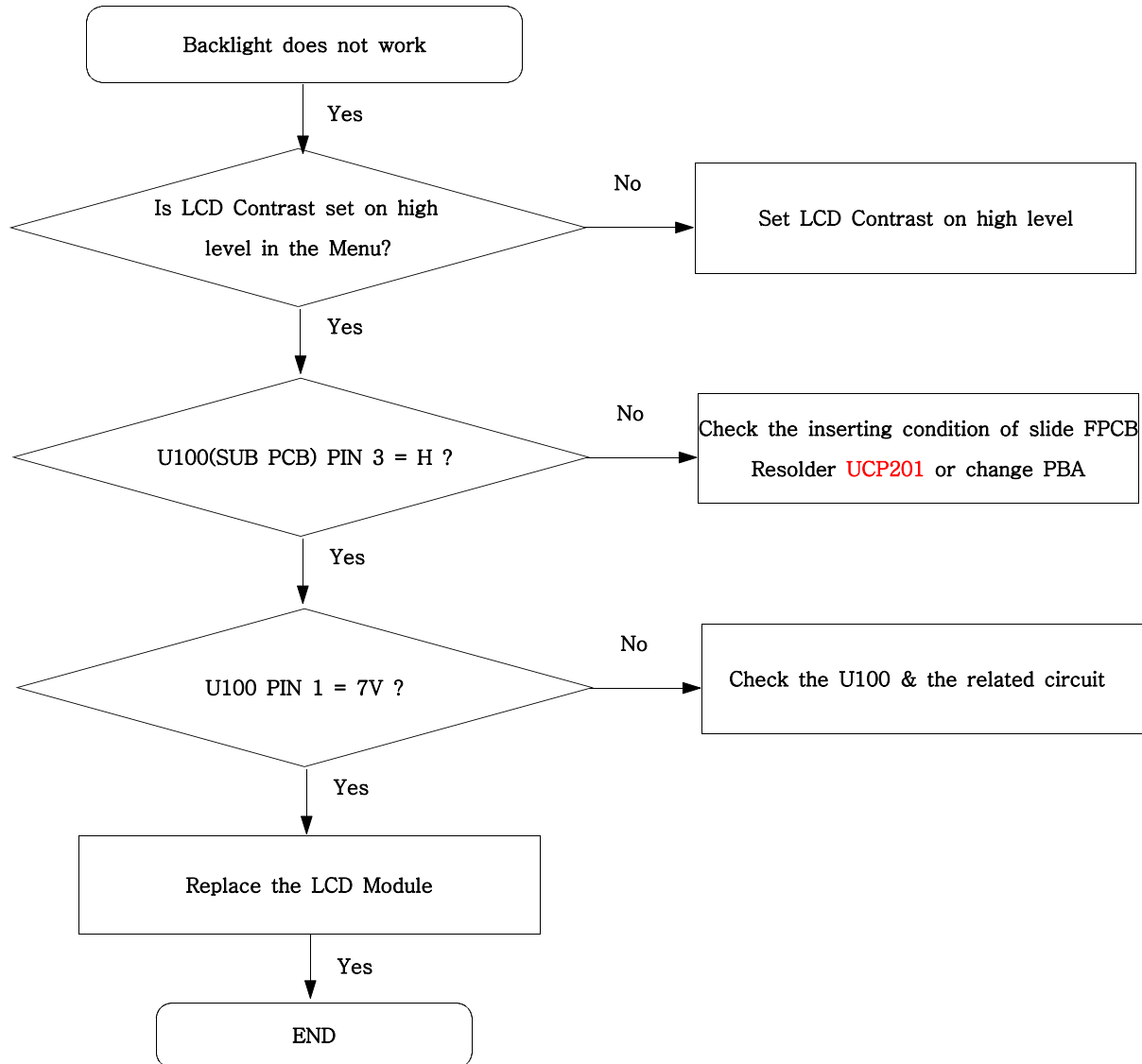

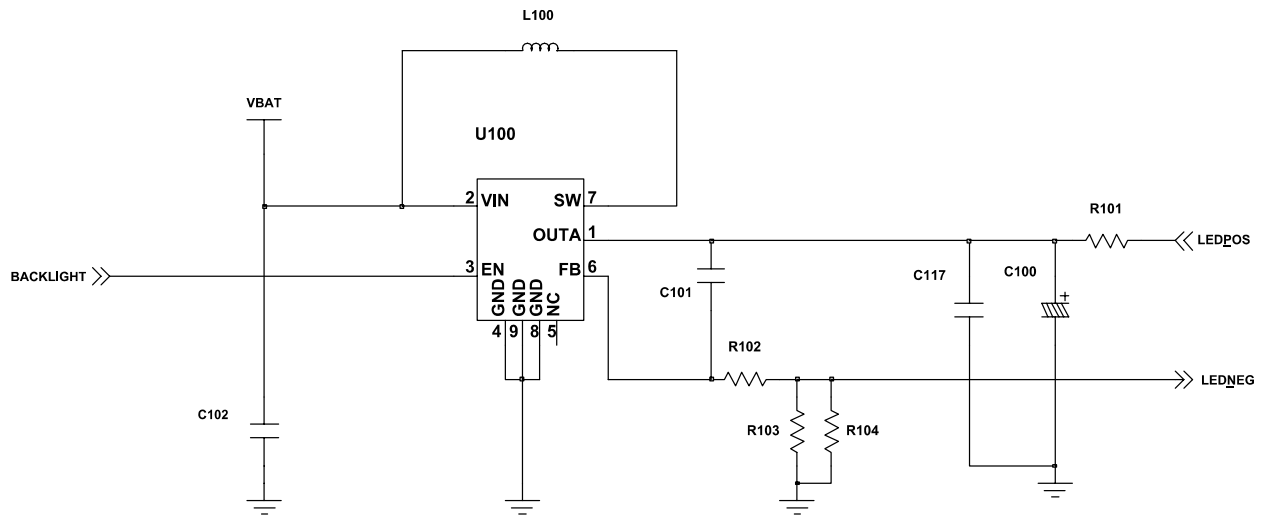

LCDBACKLIGHTIC

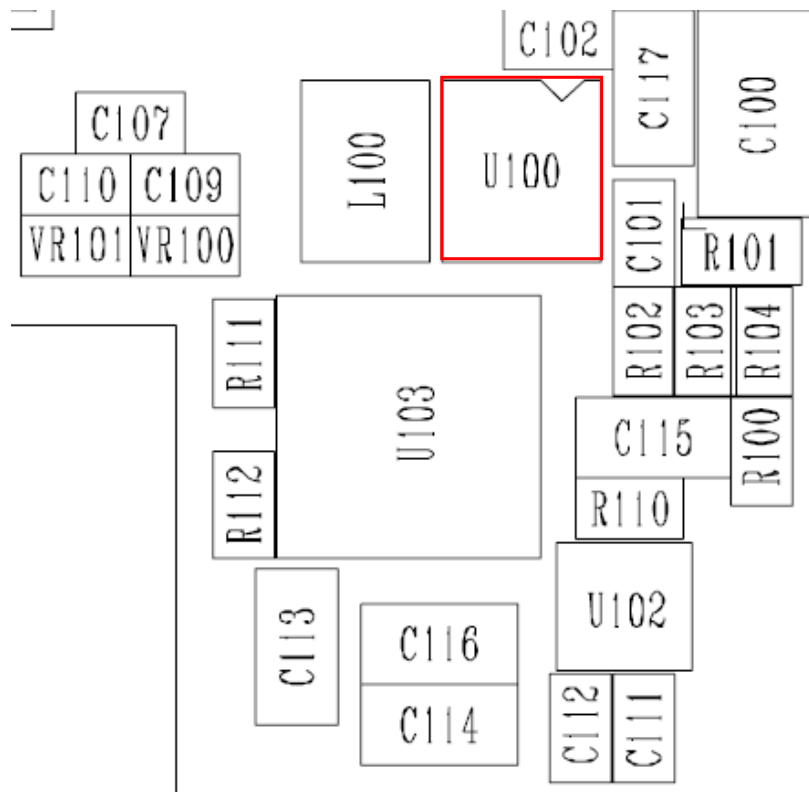

9-10. Key Back Light

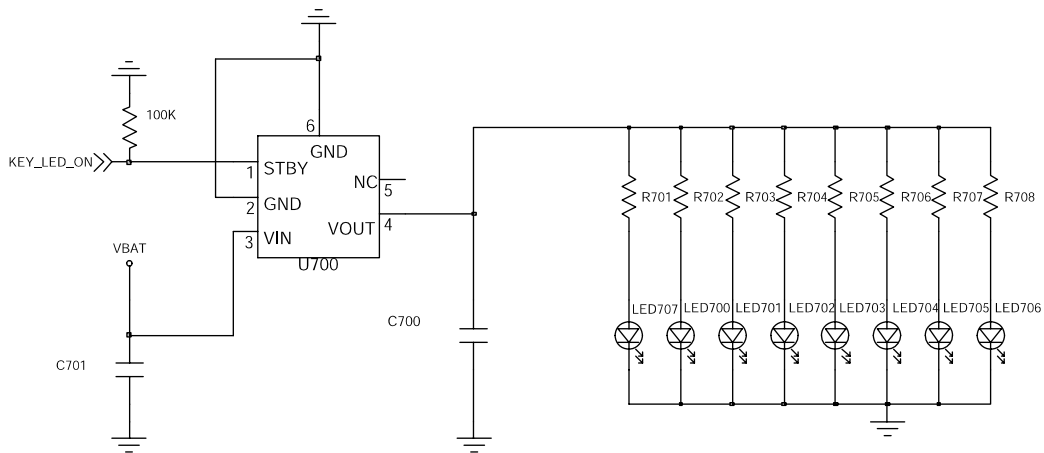
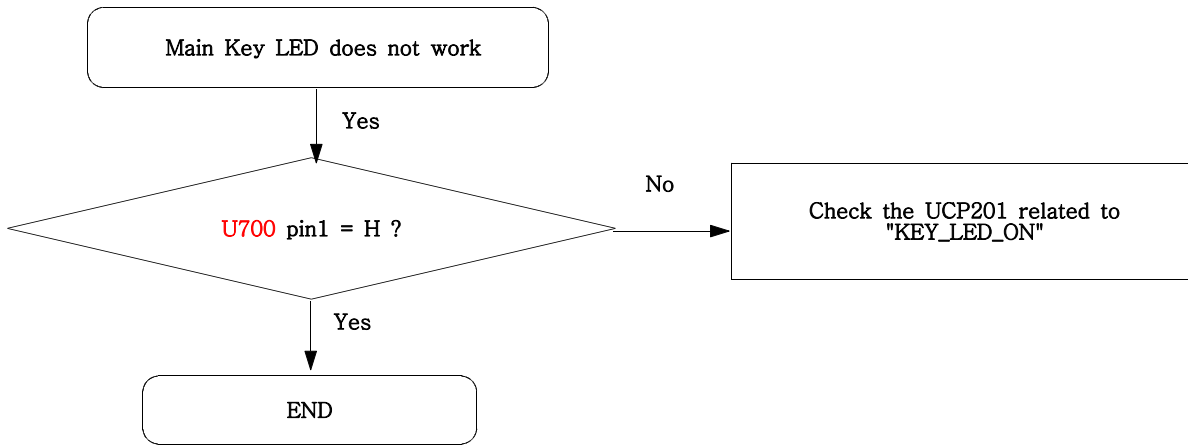

KEY_LED

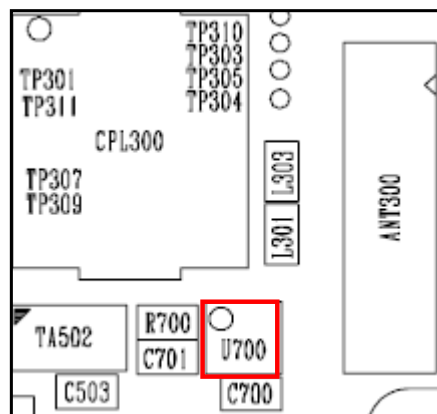

9-11. Camera part

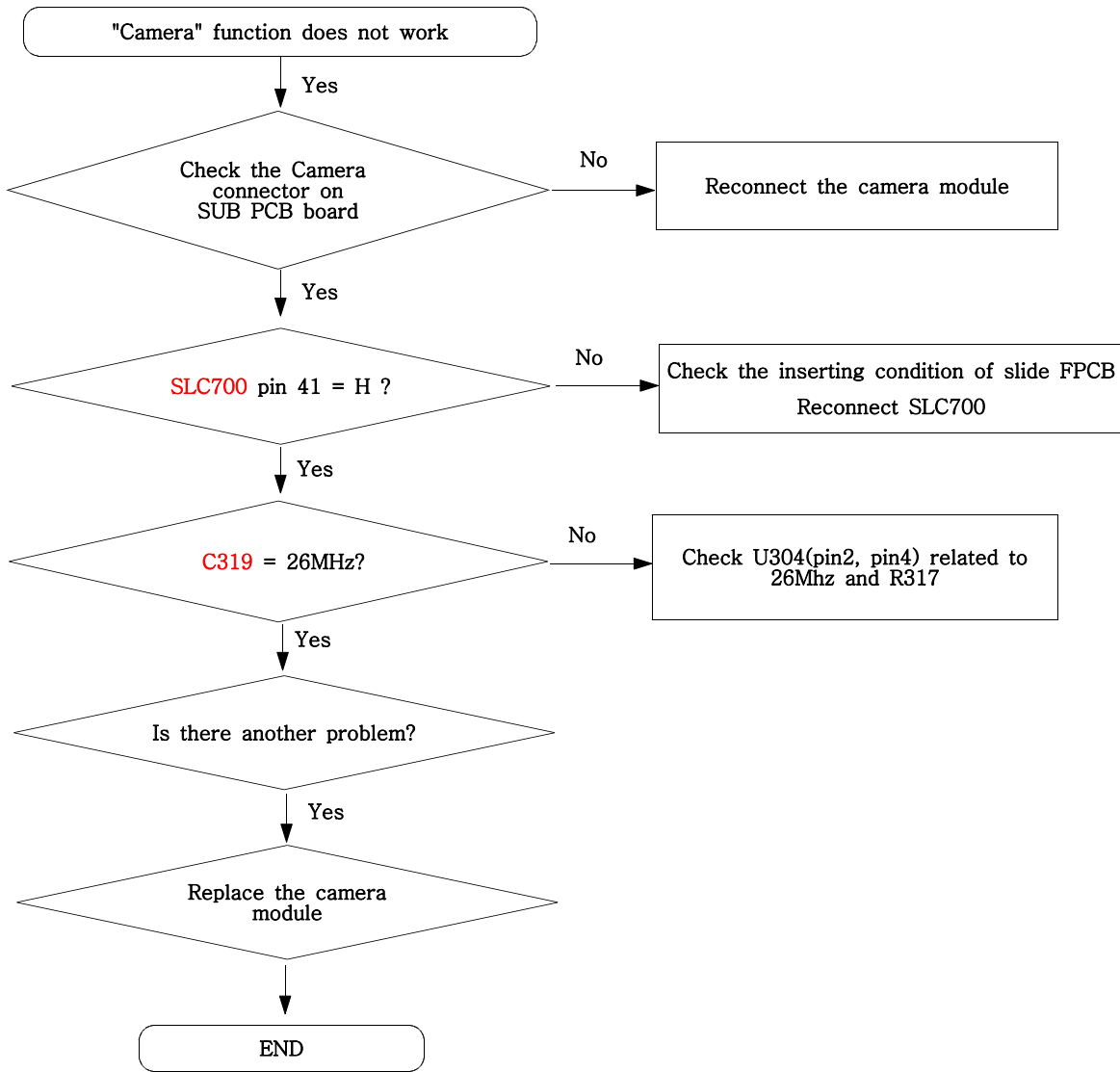

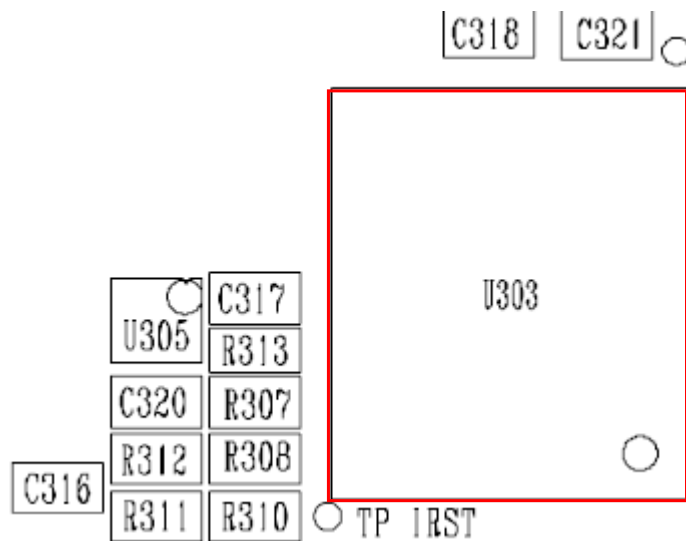
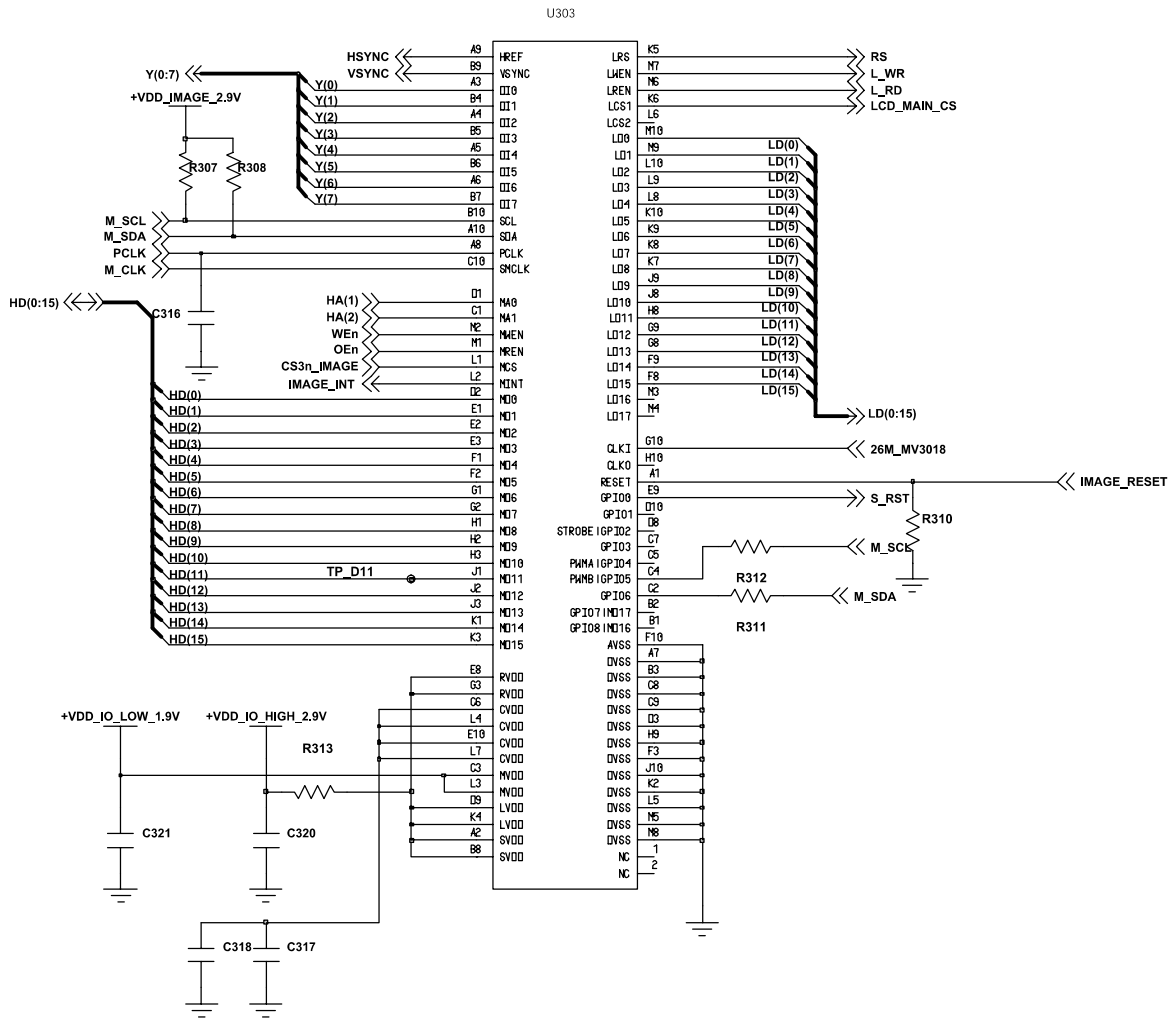

9-12. GSM Receiver

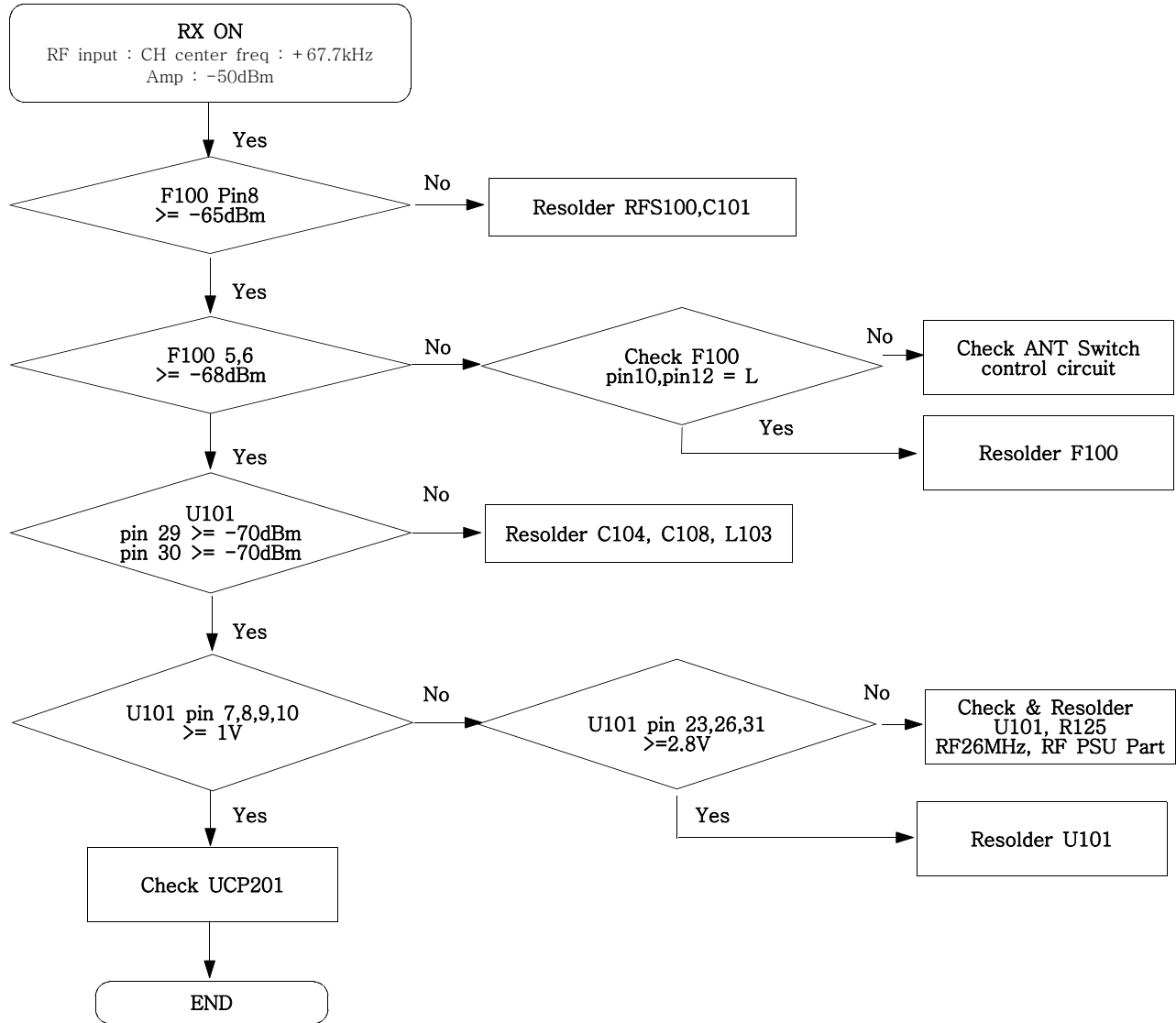

9-13. GSM Transmitter

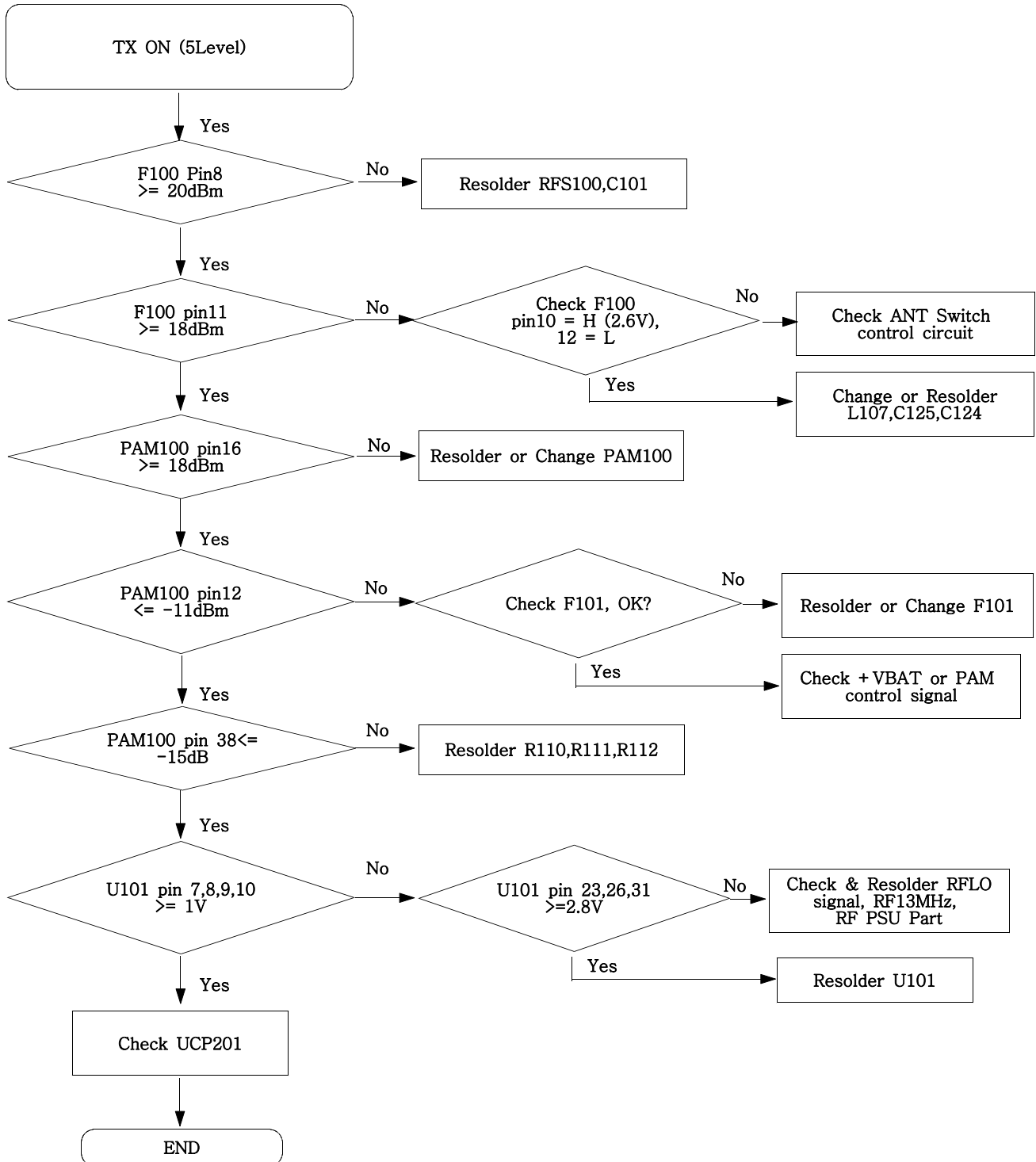

9-14. DCS Receiver

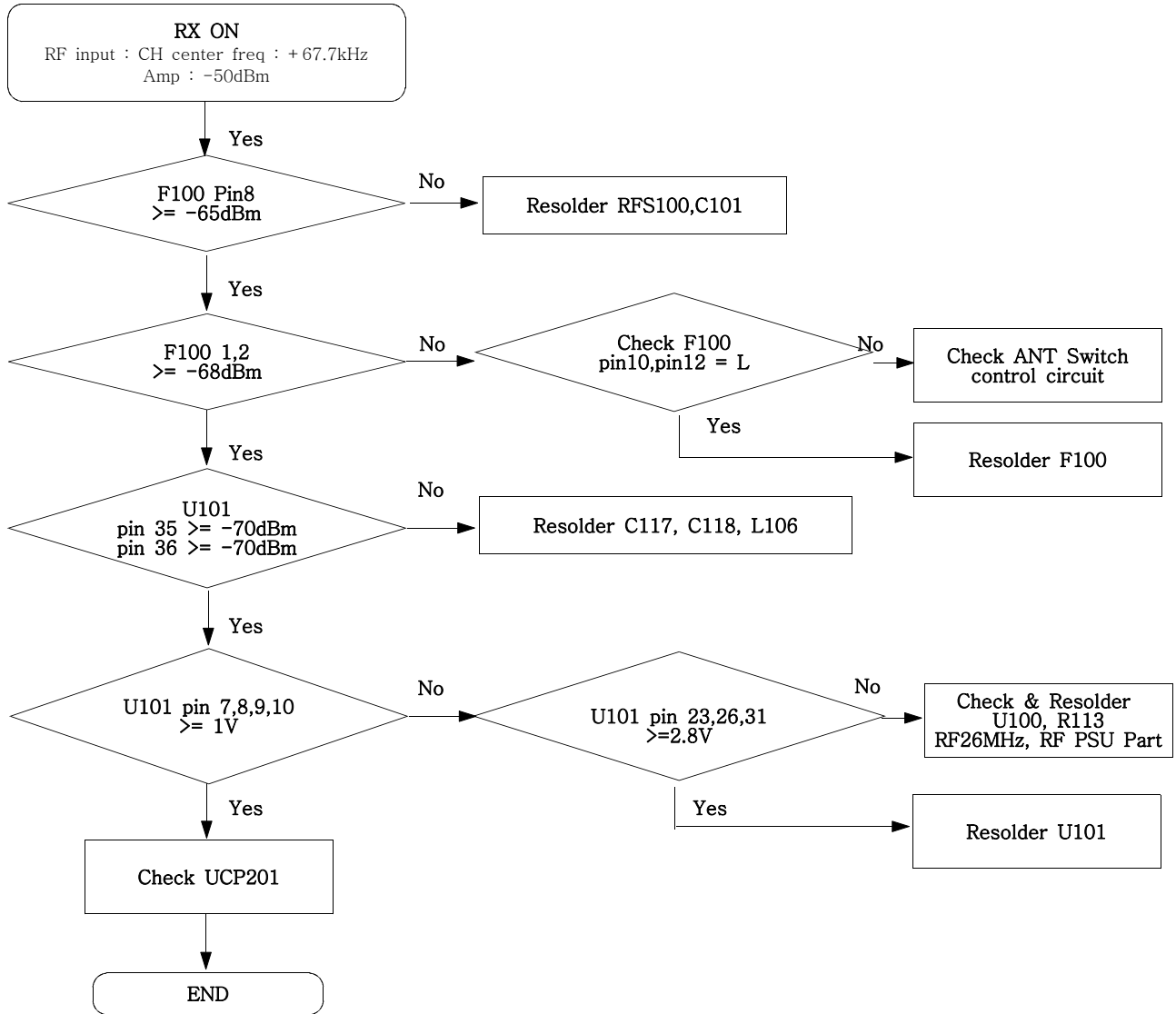

9-15. DCS Transmitter

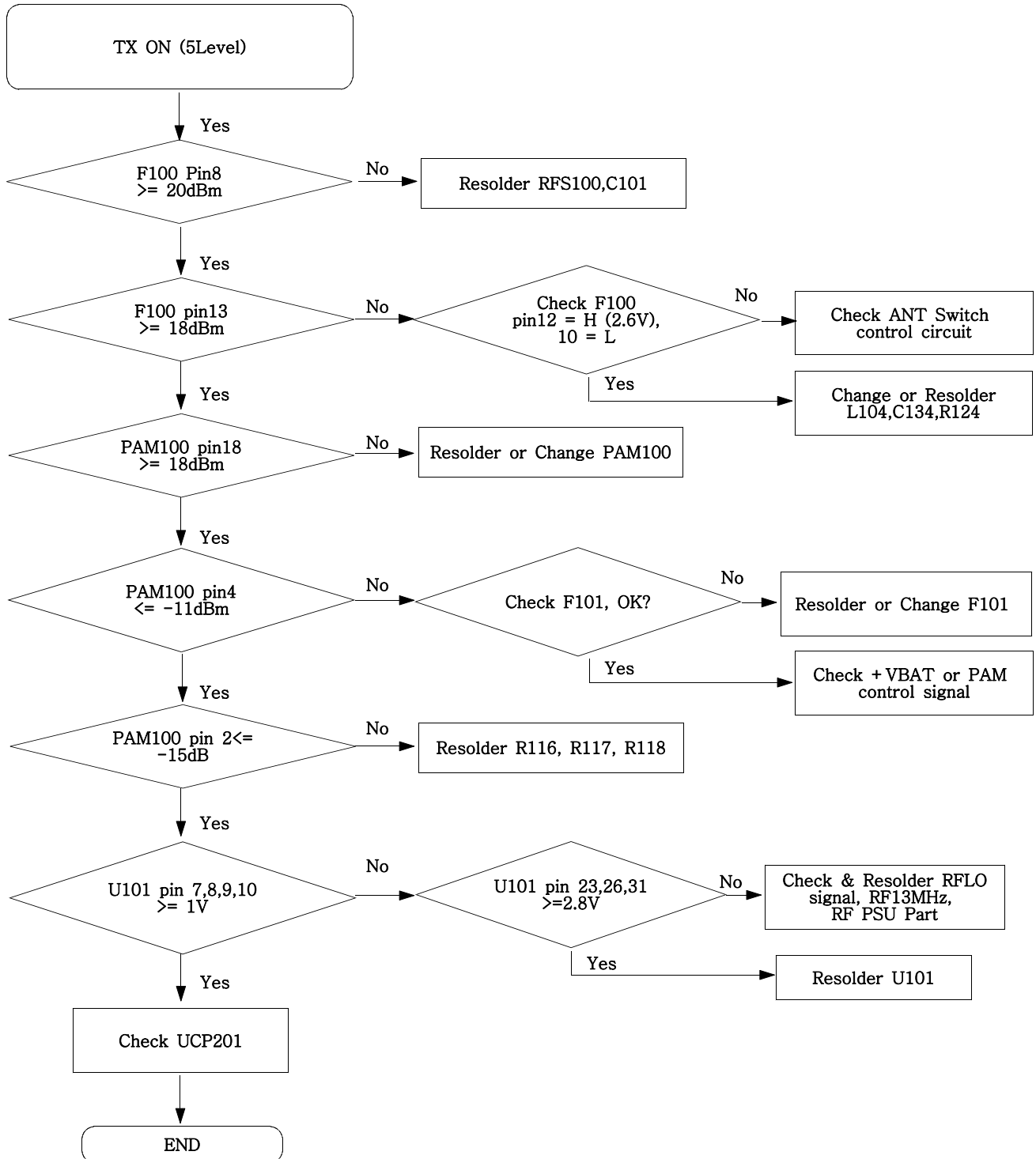

9-16. PCS Receiver

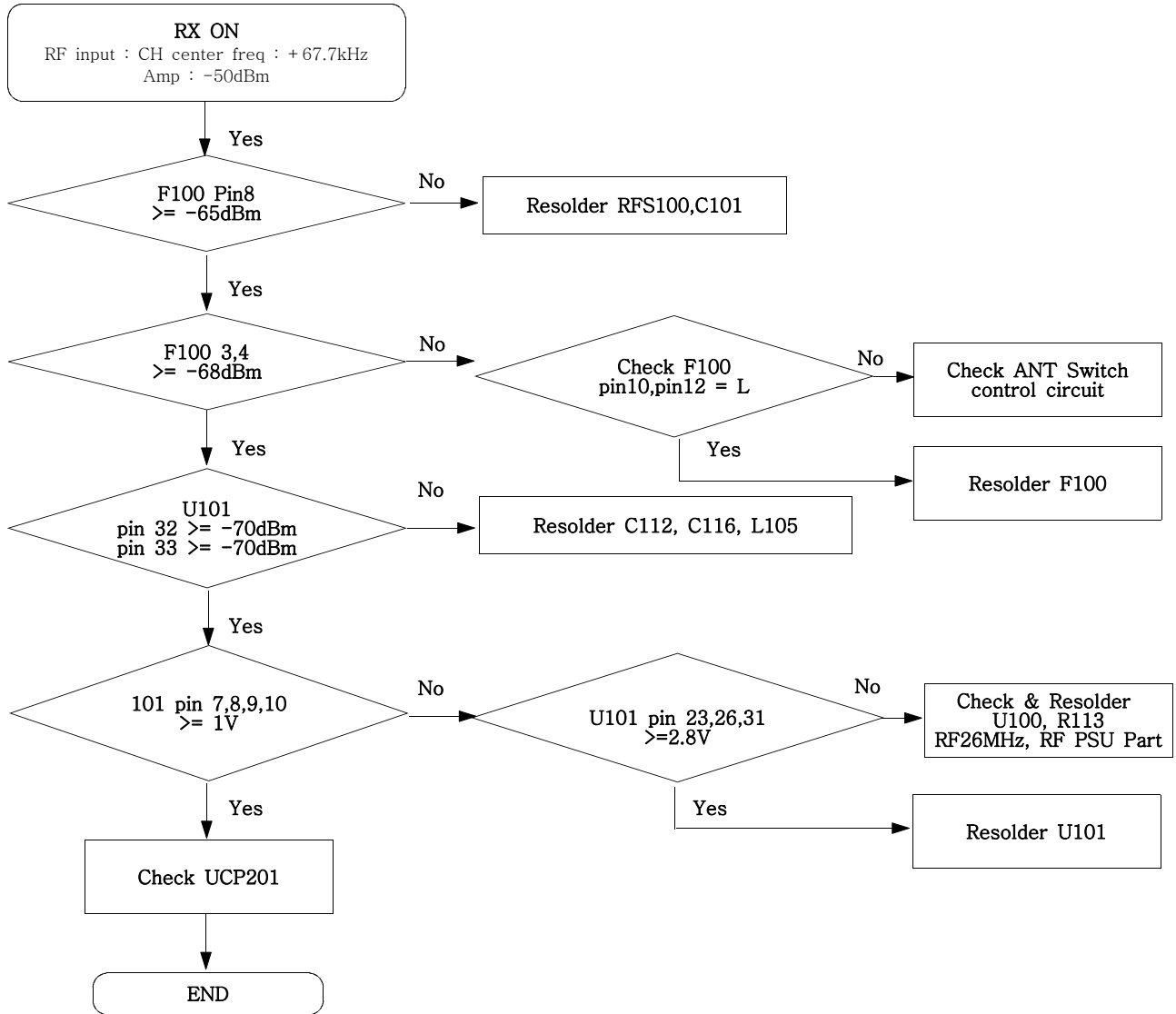

9-17. PCS Transmitter

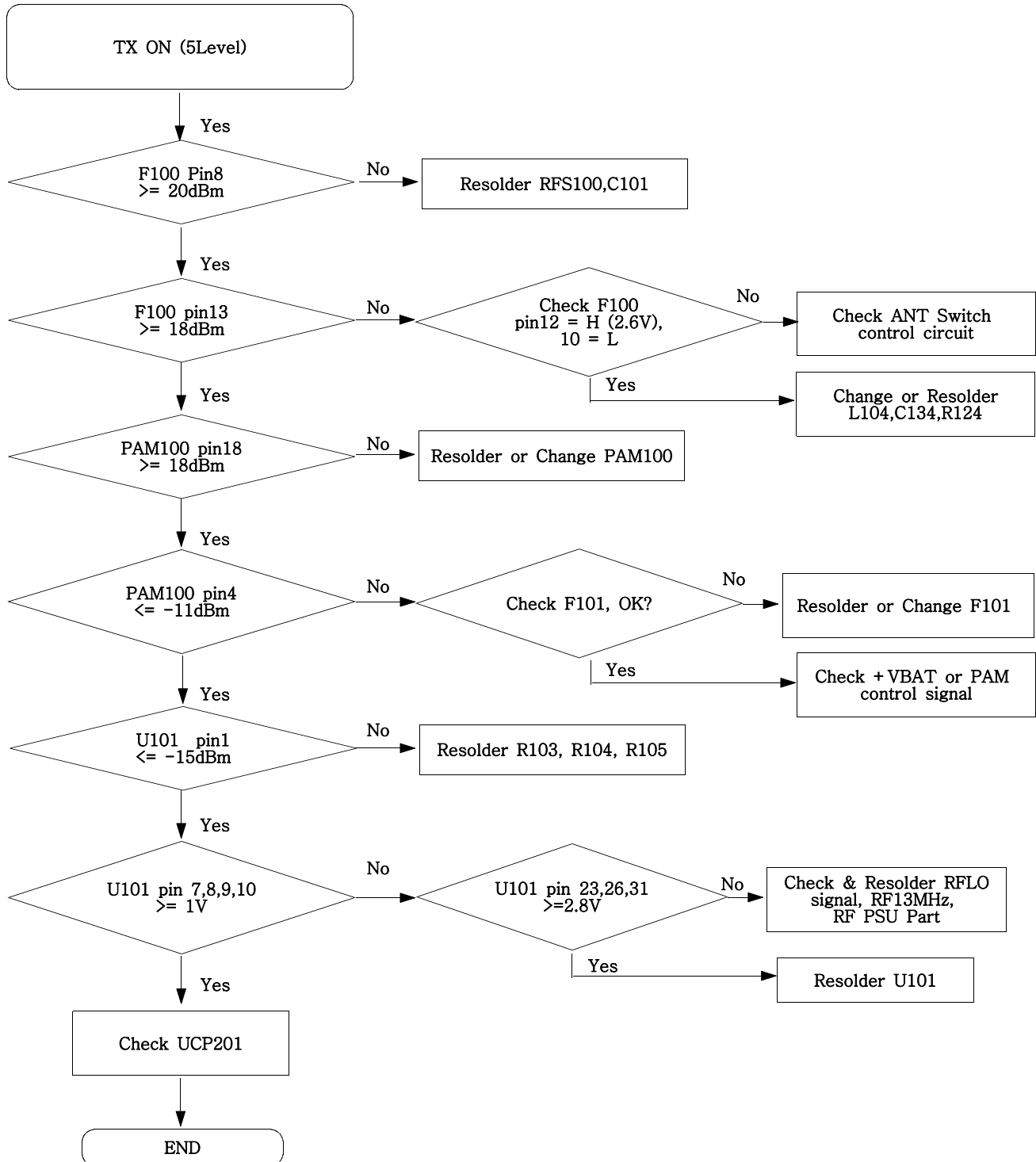

Flow Chart of Troubleshooting

	SMC100	SMC100A	SMC100B	SMC100C
YUSBSW001	H	L	L	L
YUSBSW002	L	H	L	L
YUSBSW003	L	L	L	L
YUSBSW004	L	L	L	L
YUSBSW005	L	L	H	H

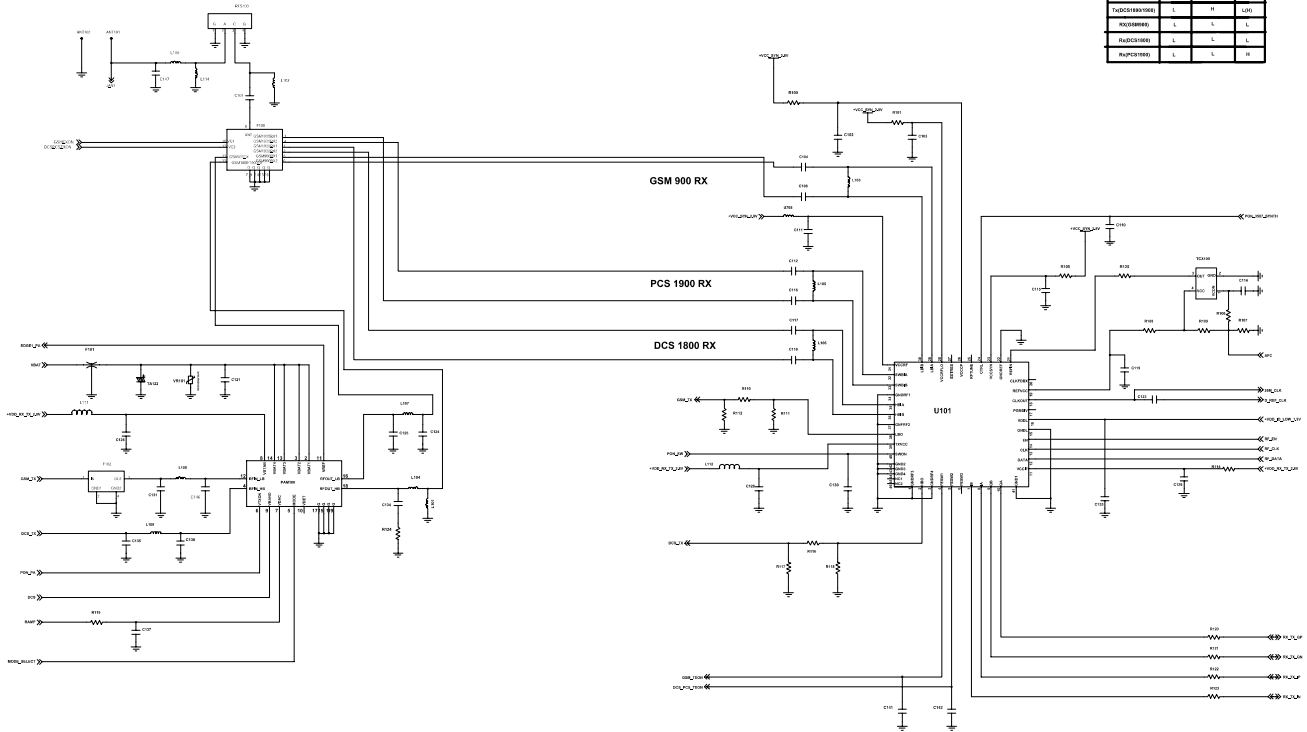

10. Reference data

10-1. Reference Abbreviate

AAC: Advanced Audio Coding.
AVC : Advanced Video Coding.
BER : Bit Error Rate
BPSK: Binary Phase Shift Keying
CA : Conditional Access
CDM : Code Division Multiplexing
C/I : Carrier to Interference
DMB : Digital Multimedia Broadcasting
EN : European Standard
ES : Elementary Stream
ETSI: European Telecommunications Standards Institute
MPEG: Moving Picture Experts Group
PN : Pseudo-random Noise
PS : Pilot Symbol
QPSK: Quadrature Phase Shift Keying
RS : Reed-Solomon
SI : Service Information
TDM : Time Division Multiplexing
TS : Transport Stream

11. Disassembly and Assembly Instructions

11-1. Disassembly

1 Unscrew 4 screws in rear cover



1) Be careful of the damage of cover and scratch.

2 Separate the rear cover

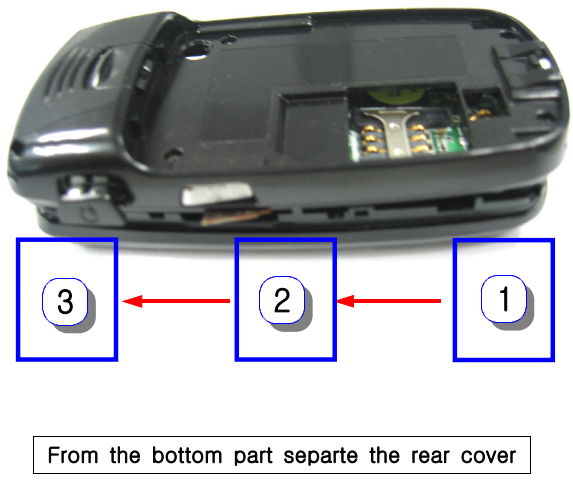

1) Be careful of the damage of cover and scratch.

3 Separate the Main PBA from Front Case with FPCB

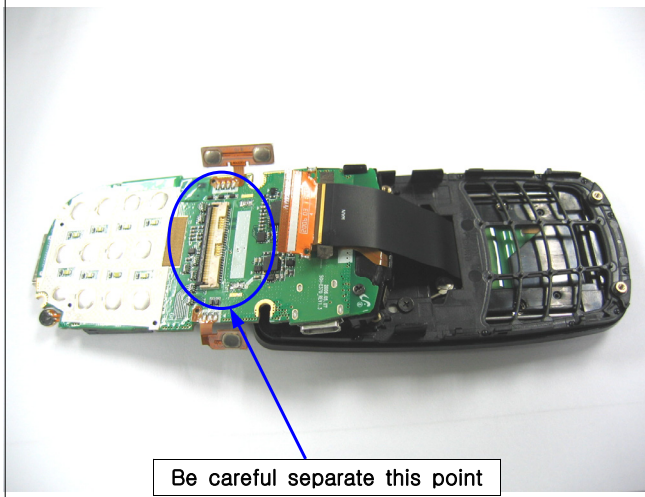

4 Unscrew 4 screws in Rear Lower

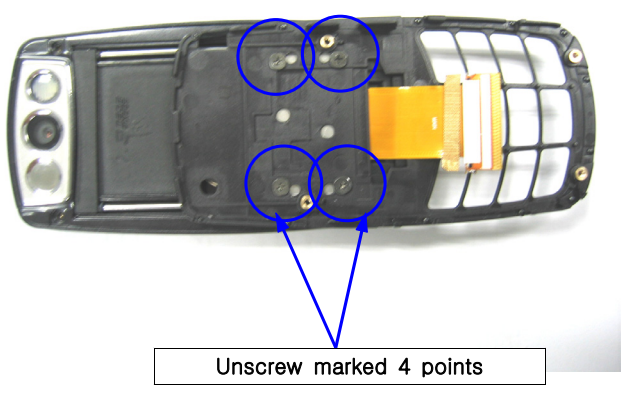

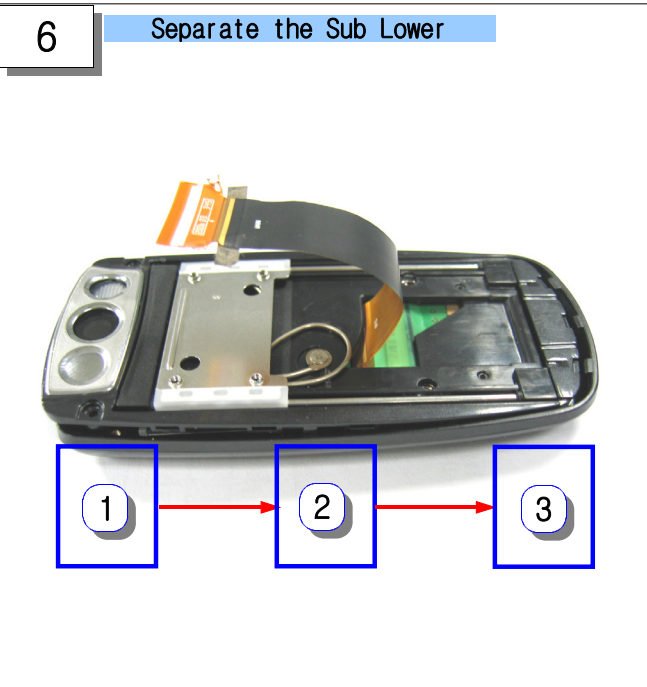
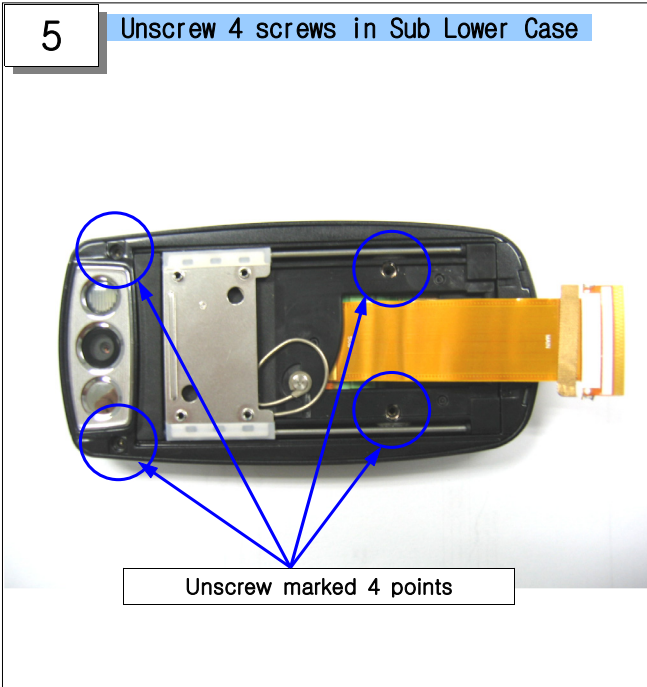

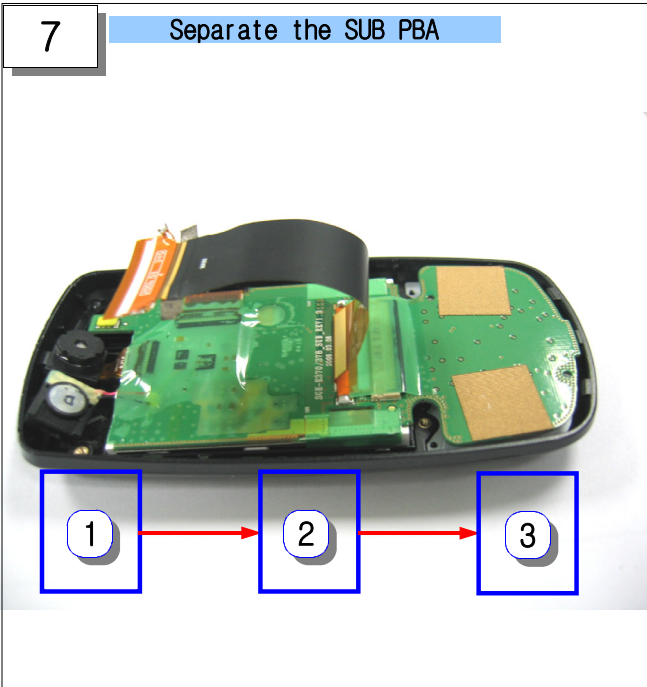

1) Separate the Lower cover from SUB upper

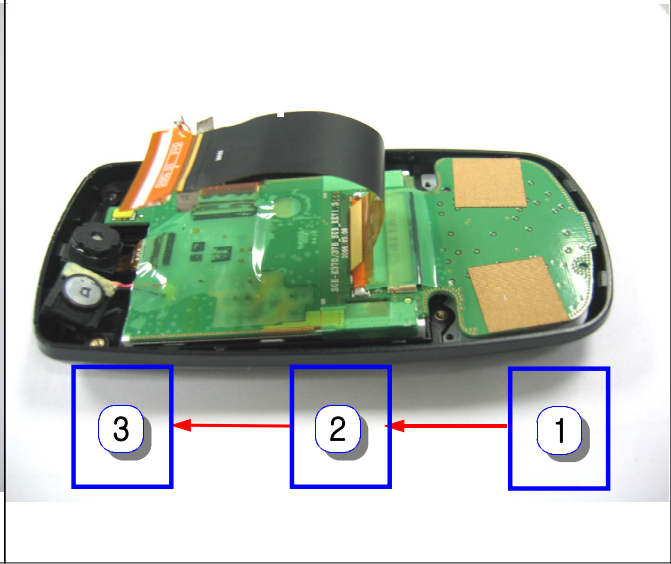

11-2. Assembly

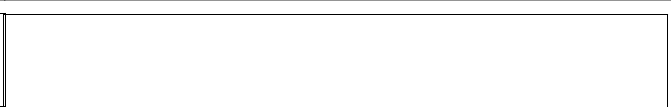
<p>1 Inserting the Sub PBA with LCD module to the Sub Upper case</p> 	<p>2 Place Sub PBA with Receiver and Camera on the Sub Upper Case</p> 
	

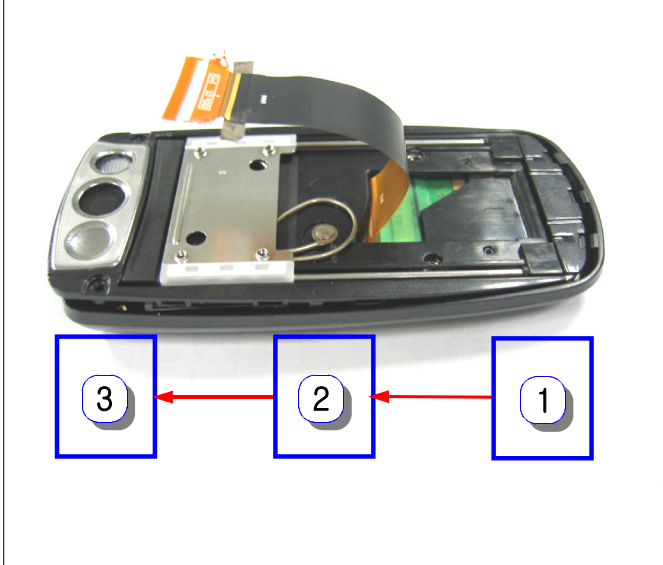
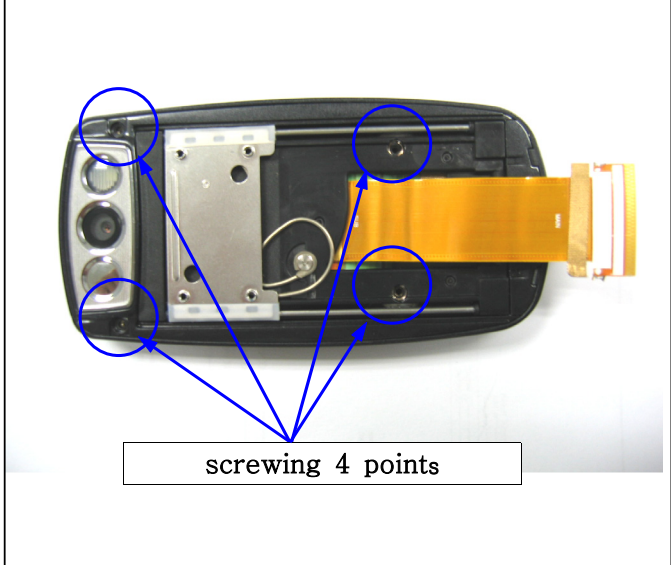
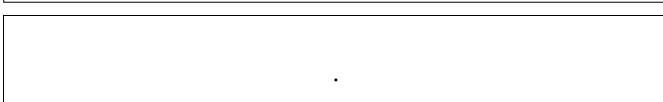
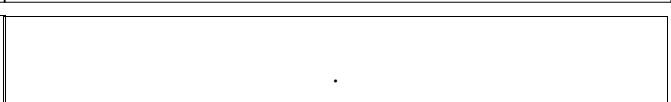
<p>3 Insert Sub Lower to Sub Upper</p> 	<p>4 Screw to the Sub Lower</p>  <p>screwing 4 points</p>
	

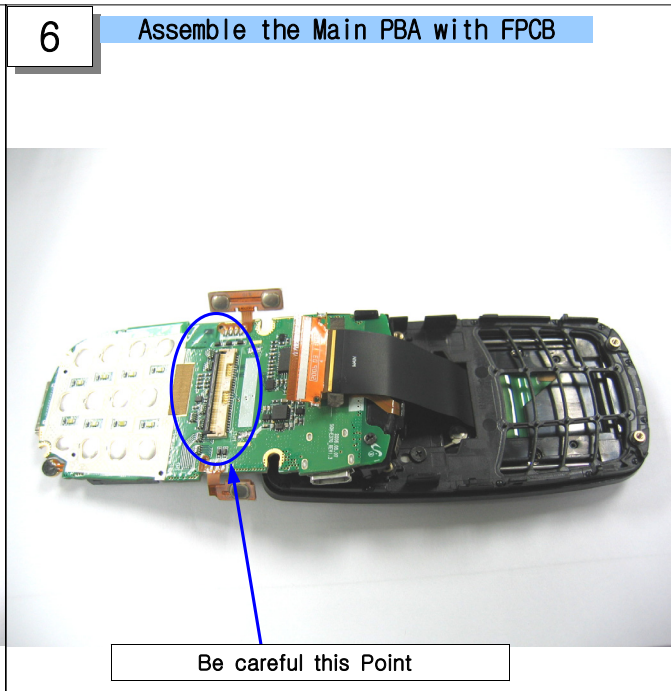
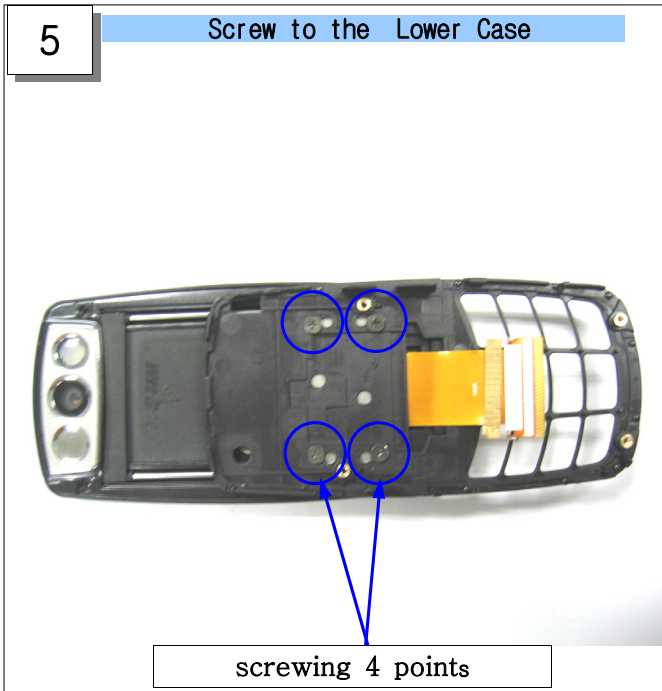

1) Insert the FPCB
2) Assemble the Main PBA

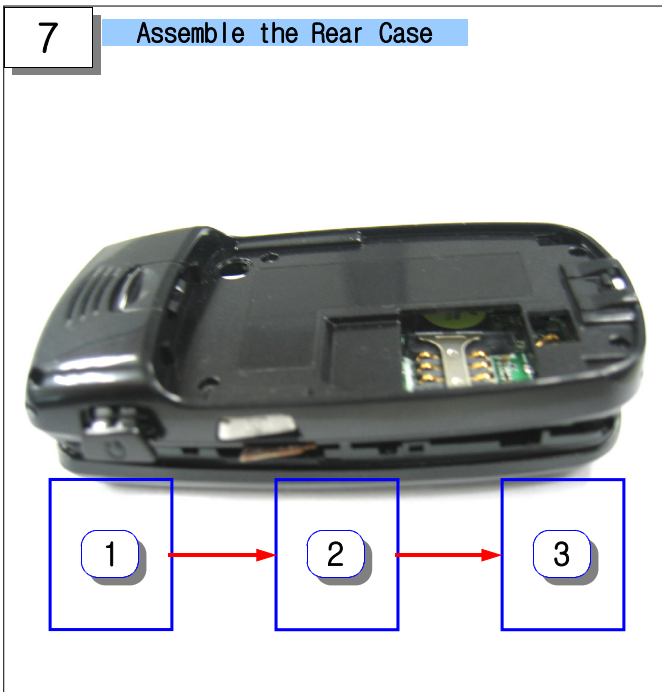

11-3. FPCB KIT Assembly

1

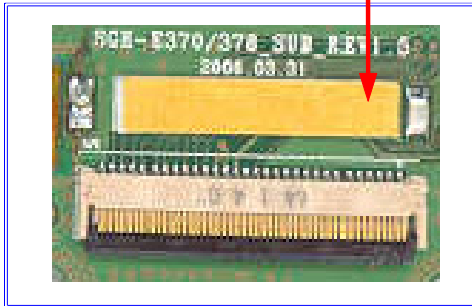

1. Remove the cover from the adhesive tape (SUB PBA)

2



MAIN FPCB

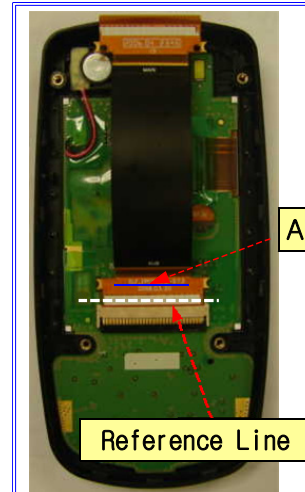

1. Insert MAIN FPCB to the white silk line, and then press the 'A' portion for safe connection

*** Caution**

1. Be care of damaging SUB PBA when using a pair of tweezers

*** Caution**

1. Confirm the direction whether it is MAIN or SUB side.
2. Confirm that the FPCB is fully inserted.

3

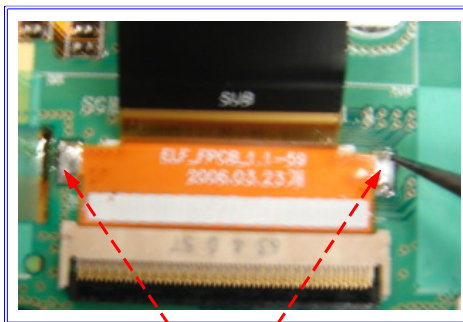

soldering point

1. Solder on the both sides.

*** Caution**

1. Be care of damaging SUB PBA when using a pair of tweezers
2. Soldering temperature : 350~380°C

4



TAPE SUB FPCB SHORT

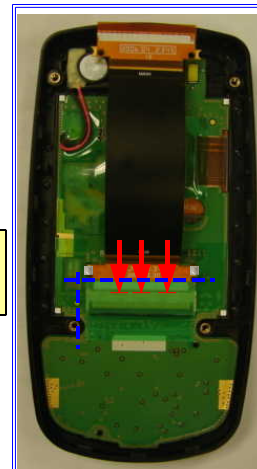

1. Attach an insulating tape up to the BLUE reference line.
2. Press on the surface of tape uniformly.

*** Caution**

1. Reattach the insulating tape when located wrong.

<div data-bbox="167 220 240 268" data-label="Text"> <p>5</p> </div> <div data-bbox="375 235 748 703" data-label="Image"> </div> <div data-bbox="167 745 781 793" data-label="Text"> <p>1. Fold the FPCB downside.</p> </div>	<div data-bbox="820 220 893 268" data-label="Text"> <p>6</p> </div> <div data-bbox="938 306 1455 646" data-label="Image"> </div> <div data-bbox="820 745 1455 821" data-label="Text"> <p>1. Fold the MAIN side of FPCB lightly and unfold</p> </div>
<div data-bbox="167 930 716 1003" data-label="Text"> <p>* Caution 1. FPCB should be folded without tilting.</p> </div>	<div data-bbox="820 930 1373 1003" data-label="Text"> <p>* Caution 1. FPCB should be folded without tilting.</p> </div>
<div data-bbox="167 1077 240 1125" data-label="Text"> <p>7</p> </div> <div data-bbox="248 1163 725 1455" data-label="Image"> </div> <div data-bbox="167 1528 797 1612" data-label="Text"> <p>1. Remove the cover from the adhesive tape (MAIN PBA)</p> </div>	<div data-bbox="820 1077 893 1125" data-label="Text"> <p>8</p> </div> <div data-bbox="865 1155 1414 1428" data-label="Image"> </div> <div data-bbox="820 1528 1455 1612" data-label="Text"> <p>1. Insert MAIN FPCB to the white silk line(A) 2. Press the 'B' portion for safe connection</p> </div>
<div data-bbox="167 1789 797 1862" data-label="Text"> <p>* Caution 1. Be care of damaging MAIN PBA when using a pair of tweezers</p> </div>	<div data-bbox="820 1789 1455 1862" data-label="Text"> <p>* Caution 1. Be care of inseting not enough and being torn.</p> </div>

9



Soldering point

1. Solder on the both sides.

*** Caution**

1. Be care of damaging MAIN PBA when using a pair of tweezers
2. Soldering temperature : 350~380°C

10



TAPE MAIN
FPCB EMI 2

1. Attach an EMI adhesive tape starting left GND pad.
2. Remove the cover.

*** Caution**

1. Follow Red reference line when putting on tape

11

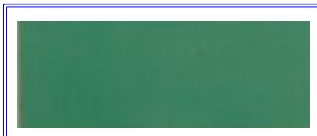

TAPE MAIN
FPCB SHORT

1. Attach an insulating tape to meet with EMI tape

*** Caution**

1. Be care of damaging MAIN PBA when using a pair of tweezers
2. Both side of tape should not be crossed out of the PBA

12

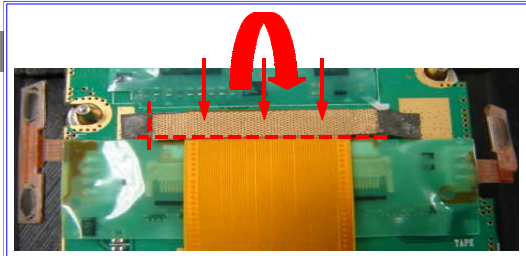



TAPE MAIN
FPCB EMI 1

1. Fold the FPCB downside.
2. Attach an EMI tape.

*** Caution**

1. EMI tape should not lean to one side.

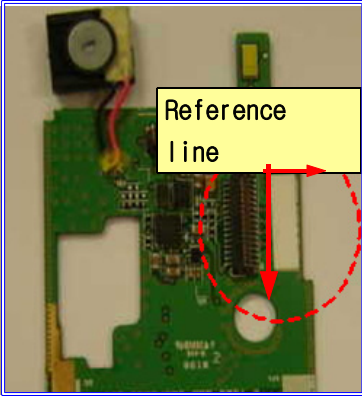
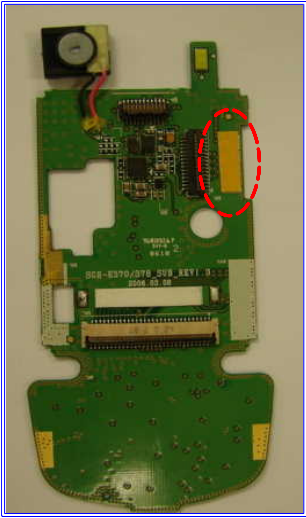
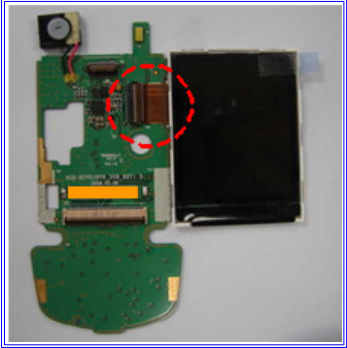
11-4. LCD KIT Assembly

<div data-bbox="164 205 245 258" style="border: 1px solid black; padding: 2px; width: fit-content;">1</div> <div data-bbox="175 281 342 485" style="border: 1px solid blue; padding: 5px; margin: 10px 0;">  </div> <div data-bbox="164 520 362 562" style="border: 1px solid black; padding: 2px; width: fit-content;">TAPE LCD FPCB</div> <div data-bbox="391 268 751 661" style="border: 1px solid blue; padding: 5px; margin: 10px 0;">  </div> <div data-bbox="164 705 808 842" style="border: 1px solid black; padding: 5px;"> <ol style="list-style-type: none"> 1. Make certain that the external appearance of TAPE is clear. 2. Attach a tape up to the reference line. </div>	<div data-bbox="824 205 906 258" style="border: 1px solid black; padding: 2px; width: fit-content;">2</div> <div data-bbox="1016 205 1320 720" style="border: 1px solid blue; padding: 5px; margin: 10px 0;">  </div> <div data-bbox="824 747 1458 842" style="border: 1px solid black; padding: 5px;"> <ol style="list-style-type: none"> 1. Confirm that the TAPE is attached correctly. </div>
<p>※ Caution</p> <ol style="list-style-type: none"> 1. Be care of damaging SUB PBA when using a pair of tweezers. 2. The TAPE should be located accurately. 	<p>※ Caution</p> <ol style="list-style-type: none"> 1. Reattach the adhesive tape when located wrong.
<div data-bbox="164 1098 245 1150" style="border: 1px solid black; padding: 2px; width: fit-content;">3</div> <div data-bbox="334 1157 678 1503" style="border: 1px solid blue; padding: 5px; margin: 10px 0;">  </div> <div data-bbox="164 1608 808 1650" style="border: 1px solid black; padding: 5px;"> <ol style="list-style-type: none"> 1. Insert the LCD FPCB to the connector and fix it. </div>	<div data-bbox="824 1098 906 1150" style="border: 1px solid black; padding: 2px; width: fit-content;">4</div> <div data-bbox="997 1150 1338 1520" style="border: 1px solid blue; padding: 5px; margin: 10px 0;">  </div> <div data-bbox="824 1608 1458 1650" style="border: 1px solid black; padding: 5px;"> <ol style="list-style-type: none"> 1. Remove the cover of adhesive tape. </div>
<p>※ Caution</p> <ol style="list-style-type: none"> 1. Be care of damaging FPCB when using a pair of tweezers. 	<p>※ Caution</p> <ol style="list-style-type: none"> 1. Be care of damaging LCD when using a pair of tweezers.

5



1. confirm the clearance of region indicated.

※ Caution

1.Remove the cover of tape if there is not clear.

6

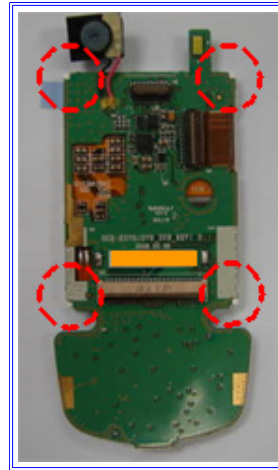

1. Attach the LCD to SUB PBA by adjusting coner .

※ Caution

1. Confirm that the LCD is located correctly.

7

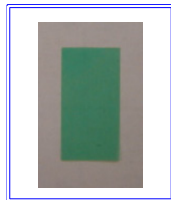

TAPE SLIDE
MODULE EM1

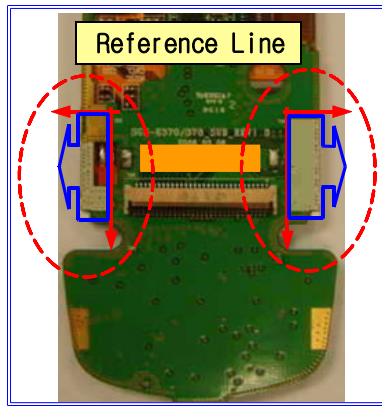

1. Make certain that the external apperance of TAPE is clear.
2. Attach a tape up to the reference line.

※ Caution

1. Be care of damaging SUB PBA when using a pair of tweezers.
2. The TAPE should be located accurately.

8

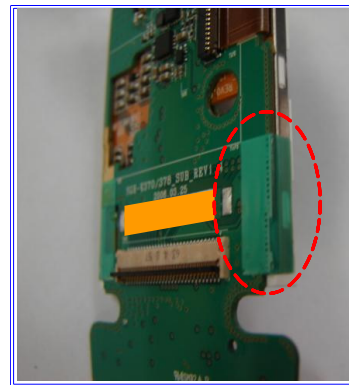

1.Confirm that the TAPE is attached correctly.

※ Caution

1. Reattach the insulating tape when located wrong.

9

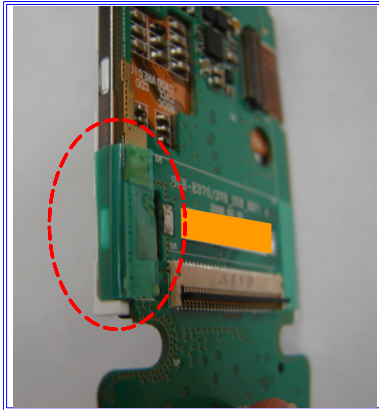

1. Confirm that the TAPE is attached correctly.

※ Caution

1. Reattach the insulating tape when located wrong.

10

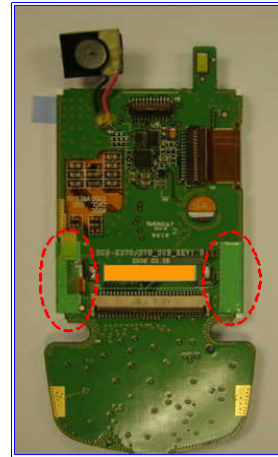

1. Finally, Confirm that the TAPE is attached correctly by front view.

※ Caution

1. Reattach the insulating tape when located wrong.

11

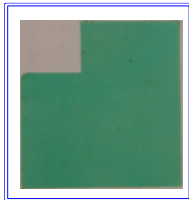

TAPE LCD
PBA
SHORT

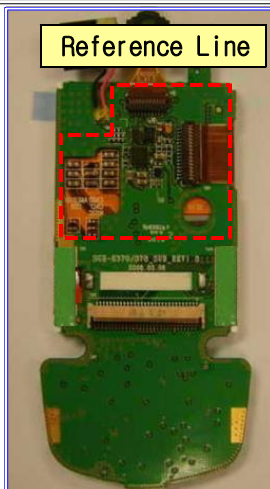

1. Make certain that the external appearance of TAPE is clear.
2. Attach a tape up to the reference line.

※ Caution

1. Be care of damaging SUB PBA when using a pair of tweezers.
2. The TAPE should be located accurately.

12

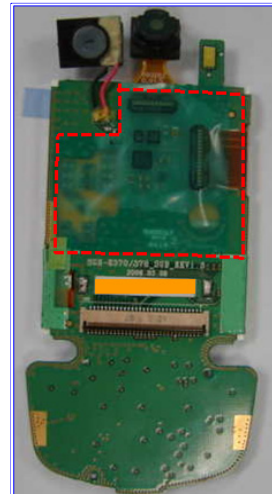

1. Confirm that the TAPE is attached correctly.

※ Caution

1. Reattach the insulating tape when located wrong.

**SAMSUNG
ELECTRONICS**

