

**SAMSUNG**

# GSM TELEPHONE SGH-D820

# ***SERVICE*** *Manual*

**GSM TELEPHONE**



**CONTENTS**

1. Specification
2. Circuit Description
3. Exploded Views and Parts List
4. Electrical Parts List
5. Block Diagrams
6. PCB Diagrams
7. Flow Chart of Troubleshooting

**SAMSUNG  
ELECTRONICS**



This Service Manual is a property of Samsung Electronics Co.,Ltd.  
Any unauthorized use of Manual can be punished under applicable  
international and/or domestic law.

© Samsung Electronics Co.,Ltd. March. 2006  
Printed in Korea.

Code No.: GH68-09648A  
BASIC.

---

# 1. Specification

---

## 1-1. GSM General Specification

	GSM850	GSM900 Phase 1	EGSM 900 Phase 2	DCS1800 Phase 1	PCS1900
Freq. Band[MHz] Uplink/Downlink	824~849 869~864	890~915 935~960	880~915 925~960	1710~1785 1805~1880	1850~1910 1930~1990
ARFCN range	128~251	1~124	0~124 & 975~1023	512~885	512~810
Tx/Rx spacing	45MHz	45MHz	45MHz	95MHz	80MHz
Mod. Bit rate / Bit Period	270.833kbps 3.692us	270.833kbps 3.692us	270.833kbps 3.692us	270.833kbps 3.692us	270.833kbps 3.692us
Time Slot Period / Frame Period	576.9us 4.615ms	576.9us 4.615ms	576.9us 4.615ms	576.9us 4.615ms	576.9us 4.615ms
Modulation	0.3GMSK	0.3GMSK	0.3GMSK	0.3GMSK	0.3GMSK
MS Power	33dBm~5dBm	33dBm~5dBm	33dBm~5dBm	30dBm~0dBm	30dBm~0dBm
Power Class	5pcl ~ 19pcl	5pcl ~ 19pcl	5pcl ~ 19pcl	0pcl ~ 15pcl	0pcl ~ 15pcl
Sensitivity	-102dBm	-102dBm	-102dBm	-100dBm	-100dBm
TDMA Mux	8	8	8	8	8
Cell Radius	35Km	35Km	35Km	2Km	2Km

## 1-2. GSM TX power class

<b>TX Power control level</b>	<b>GSM850</b>	<b>TX Power control level</b>	<b>GSM900</b>	<b>TX Power control level</b>	<b>DCS1800</b>	<b>TX Power control level</b>	<b>PCS1900</b>
5	33±3 dBm	5	33±3 dBm	0	30±3 dBm	0	30±3 dBm
6	31±3 dBm	6	31±3 dBm	1	28±3 dBm	1	28±3 dBm
7	29±3 dBm	7	29±3 dBm	2	26±3 dBm	2	26±3 dBm
8	27±3 dBm	8	27±3 dBm	3	24±3 dBm	3	24±3 dBm
9	25±3 dBm	9	25±3 dBm	4	22±3 dBm	4	22±3 dBm
10	23±3 dBm	10	23±3 dBm	5	20±3 dBm	5	20±3 dBm
11	21±3 dBm	11	21±3 dBm	6	18±3 dBm	6	18±3 dBm
12	19±3 dBm	12	19±3 dBm	7	16±3 dBm	7	16±3 dBm
13	17±3 dBm	13	17±3 dBm	8	14±3 dBm	8	14±3 dBm
14	15±3 dBm	14	15±3 dBm	9	12±4 dBm	9	12±4 dBm
15	13±3 dBm	15	13±3 dBm	10	10±4 dBm	10	10±4 dBm
16	11±5 dBm	16	11±5 dBm	11	8±4dBm	11	8±4dBm
17	9±5 dBm	17	9±5 dBm	12	6±4 dBm	12	6±4 dBm
18	7±5 dBm	18	7±5 dBm	13	4±4 dBm	13	4±4 dBm
19	5±5 dBm	19	5±5 dBm	14	2±5 dBm	14	2±5 dBm
				15	0±5 dBm	15	0±5 dBm

---

## 2. Circuit Description

---

### 2-1. SGH-D820 RF Circuit Description

#### 2-1-1. RX PART

- FRONT END MODULE(ANTENNA SWITCH MODULE + RX SAW FILTER) (F101)

It performs to switch Tx & Rx paths for GSM850, GSM900, DCS1800 and PCS1900 with logic controls below.

- FEM Control Logic Table

	FESW1	FESW2	FESW2
Tx Mode (GSM850/900)	H	L	L
Tx Mode (DCS1800/1900)	L	H	L
Rx Mode (GSM900/850)	L	L	L
Rx Mode (DCS1800)	L	L	L
Rx Mode (PCS1900)	L	L	H

- VC-TCXO (TCX100)

This module generates the 26MHz reference clock to drive the logic and RF systems.

It is turned on when the supply voltage (+VCC\_SYN) is applied.

After buffering, the 26MHz reference clock is supplied to the other parts of the system through the transceiver pin CLKOUT.

- Transceiver (U102)

This chip is fully integrated GSM & GPRS quad-band transceiver with RF VCO, loop filters and most of the passive components required in it.

It also fully integrated fractional N RF synthesizer with AFC control possibility, RF VCO with integrated supply regulator. Semi integrated reference oscillator with integrated supply regulator.

RF Receiver front-end amplifies the E-GSM900(GSM850), DCS1800 and PCS1900 aerial signal, convert the chosen channel down to a low IF of 100kHz.

In IF section, further amplifies the wanted channel, performs gain control to tune the output level to the desired value and rejects DC.

#### 2-1-2. TX PART

The transmitter is fully differential using a direct up conversion architecture. It consists of a signal side band power up mixer. Gain is controlled by 6 dB via 3-wire serial bus programming. The fully integrated VCO and power mixer achieve LO suppression, quadrature phase error, quadrature amplitude balance and low noise floor specification. Output matching/balun components drive a standard 50 ohms single ended load.

## 2-2. Baseband Circuit description of SGH-D820

### 2-2-1. PCF50603 (U400)

#### - Power Management

Eight low-dropout regulators designed specifically for GSM applications power the terminal and help ensure optimal system performance and long battery life. A programmable boost converter provides support for 1.8V, 3.0V SIMs, while a self-resetting, electronically fused switch supplies power to external accessories. Ancillary support functions, such as RTC module and High Voltage Charge pump, Clock generator, aid in reducing both board area and system complexity.

I2C BUS serial interface provides access to control and configuration registers. This interface gives a microprocessor full control of the PCF50603 and enables system designers to maximize both standby and talk times.

Supervisory functions, including a reset generator, an input voltage monitor, and a temperature sensor, support reliable system design. These functions work together to ensure proper system behavior during start-up or in the event of a fault condition (low microprocessor voltage, insufficient battery energy, or excessive die temperature).

#### - Pulse-Width Modulator

The Backlight Brightness Modulator (BBM) contains a programmable Pulse-width modulator (PWM) to modulate the intensity of a series of LED's or to control a DC/DC converter that drives LCD backlight.

This phone is using PWM control to modulate the LCD backlight brightness.

#### - Clock Generator

The Clock Generator (CG) generates all clocks for internal and external usage. The 32.768 kHz crystal oscillator provides an accurate low clock frequency for the PCF50603 and other circuitry.

### 2-2-2. LCD

D820 has just one 2.12" TFT LCD. 16-bit data lines(LD(0)~LD(15)) transfers data and commands to LCD. There are couple of control signals such as RS, LCD\_MAIN\_CS, L\_WRB, etc. RS stands for "Register Select pin." When RS = 0, data can be written to the index register or status can be read, and when RS = 1, an instruction can be issued or data can be written to or read from RAM. Read or write operation is selected according to L\_WRB signals. The data is received when the R/W bit is 0, and is transmitted when the R/W bit is 1. At the falling edge of LCD\_MAIN\_CS input, serial data transfer is initiated. On the other hand, at the rising edge of LCD\_MAIN\_CS input, the data transfer is ceased.

### 2-2-3. Key

Key recognition part is consisted of 8 ports from PCF5213EL1. KEY\_ROW(0:4) & KEY\_COL(0:4)

These signals performs with the matrix. Any input from the matrix informs the key status to key interface in the PCF5213EL1. Power on/off key is independent of the matrix. Therefore, 'power on/off' signal is directly connected with PCF50603 to turn PCF50603 on.

Two 3.3V LDOs(U716, U823) enable Main and Sub Key LED on. Main and Sub Key LED are controlled by KEYLED\_ON and SLIDER\_KEY\_ON signal respectively.

#### 2-2-4. EMI ESD Filter (F500)

This system uses the EMI ESD filter (F500) to protect the device from noises from IF CONNECTOR part.

#### 2-2-5. IF connetor (IFC500)

It has 20-pin. They are designed to allocate not only 'power and data lines'(VBAT, V\_EXT\_CHARGE, USB\_D+, +VBUS, USB\_D-, TXD1, RXD1, AUX\_ON, EXT1, EXT2 and GND) but also Earphone lines(EAMMIC\_P/N, EARS PK\_R/L, EAR\_SWITCH, EARS PK\_COM and EAR\_ADC). They connected to power supply IC, microprocessor, signal processor IC and Earphone.

#### 2-2-6. Battery Charge Management

D820 has a complete constant-current/constant-voltage linear charger for single cell lithium-ion batteries inside.

If Travel Adapter is connected, "V\_EXT\_CHARGE" begins to provide the charger IC (to battery) with power (current).

When the charging operation is done, "END\_OF\_CHG" informs it to PCF5213EL1 to stop the operation. "CHG\_ON" signal enables the charger IC to operate in adequate circumstances.

#### 2-2-7. Audio - Part

D820 has several audio-outputs such as stereo speaker, receiver, earphone, etc. HFR P/N signals from CPU are connected to the receiver. MIC\_CP/N are connected to the main MIC and MIC\_CP2/N2 as well.

SAPA1D2 is a Class-D amplifier for outputting sounds that are used by mobile phones including MP3 playback, melodies, voice output on speaker phone mode and so on..

STG3699(U515) is an analog switch to connect SAPA1D2 input port to main DSP or CODEC Chip.

#### 2-2-8. Memory (UME307)

D820 has KBH10PD00M-D414 as a memory module.

The KBH10PD00M-D414 is a Multi Chip Package Memory which combines 256Mbit Synchronous Burst Multi Bank NOR Flash Memory and 1Gbit OneNAND Flash and 256Mbit Synchronous Burst UtRAM.

It has 16 bit data line, HD[0~15] which is connected to PCF5213 and CL8522S5(Multi-media chip), also has 24 bit address lines, HA[1~24]. There are 3 chip select signals, CS0n\_FLASH, CS1n\_RAM, and CS4n\_NAND.

In the writing process, WEn is fallen to low and it enables writing process to operate. During reading process,

OEn is fallen to low and it enables reading process to operate. Each chip select signals in the PCF5213EL1 choose different types of memory.

#### 2-2-9. PCF5213EL1 (UCP200)

The PCF5213EL1 is mainly composed of embeded DSP and ARM core. The DSP subsystem includes the Saturn DSP core with embedded RAM and ROM, and a set of peripherals. It has 24k×16 bits PRAM, 104k×16 bits, 32k×16 XYRAM and 63k×16 XYROM in the DSP.

The ARM946E-S consists of an ARM9E-S processor core, 8 kbyte instruction cache and 8 kbyte data cache, tightly-coupled ITCM (Instruction Tightly Coupled Memory) and DTCM (Data Tightly Coupled Memory) memories, a memory protection unit, and an AMBA (Advanced Microcontroller Bus Architecture) AHB (Advanced High-performance Bus) bus interface with a write buffer. HD(0:15), data lines and HA(0:23), address lines are connected to KBH10PD00M-D414(memory) and CL8522S5(Multi-media chip)

. It has 64 kbyte SC RAM (0.5 Mbit) and 32 kbyte SC program ROM for bootstrap loader in the ARM core.

HD(0:15), data lines and HA(0:23), address lines are connected to memory and CL8522S5 to communicate. ARM core and DSP core. OEn, WEn control the access of memory. KROW, and KCOL recognize the key string input status. It has J-TAG control pins (TDI/TDO/TCK) for ARM and DSP core. J-SEL signal controls different access to ARM and DSP core. ADC(Analog to Digital Convertor) receives the condition of temperature, battery type and battery voltage.

### 2-2-10. TCO-5871U (TCX100, 26MHz)

This system has the 26MHz TCXO, TCO-5871U from Toyocom. AFC controlling signal from PCF5213EL1 controls frequency from 26MHz X-tal. It generates the clock frequency. This clock is connected to PCF5213EL1 and UAA3587.

### 2-2-11. CL8522S5 (U303)

CL8522S5 provides rich video functions up to 30-frame display with minimized tasks in the handset main processor as well as hardware based real-time JPEG compression and decompression. CL8522S5 directly transmits and previews the RGB data to the LCD graphic memory by processing the sensor output data according to the handset's command. It can save the raw RGB data up to VGA resolution into its image buffer and allows the host processor to download with scalable sized compressed data. It also provides I2S data bus to playback MP3 formatted data. It utilizes 16 bit data bus for communication with the main processor, including bus interface types.



### 3. Exploded View and its Parts list

#### 3-1. Exploded View

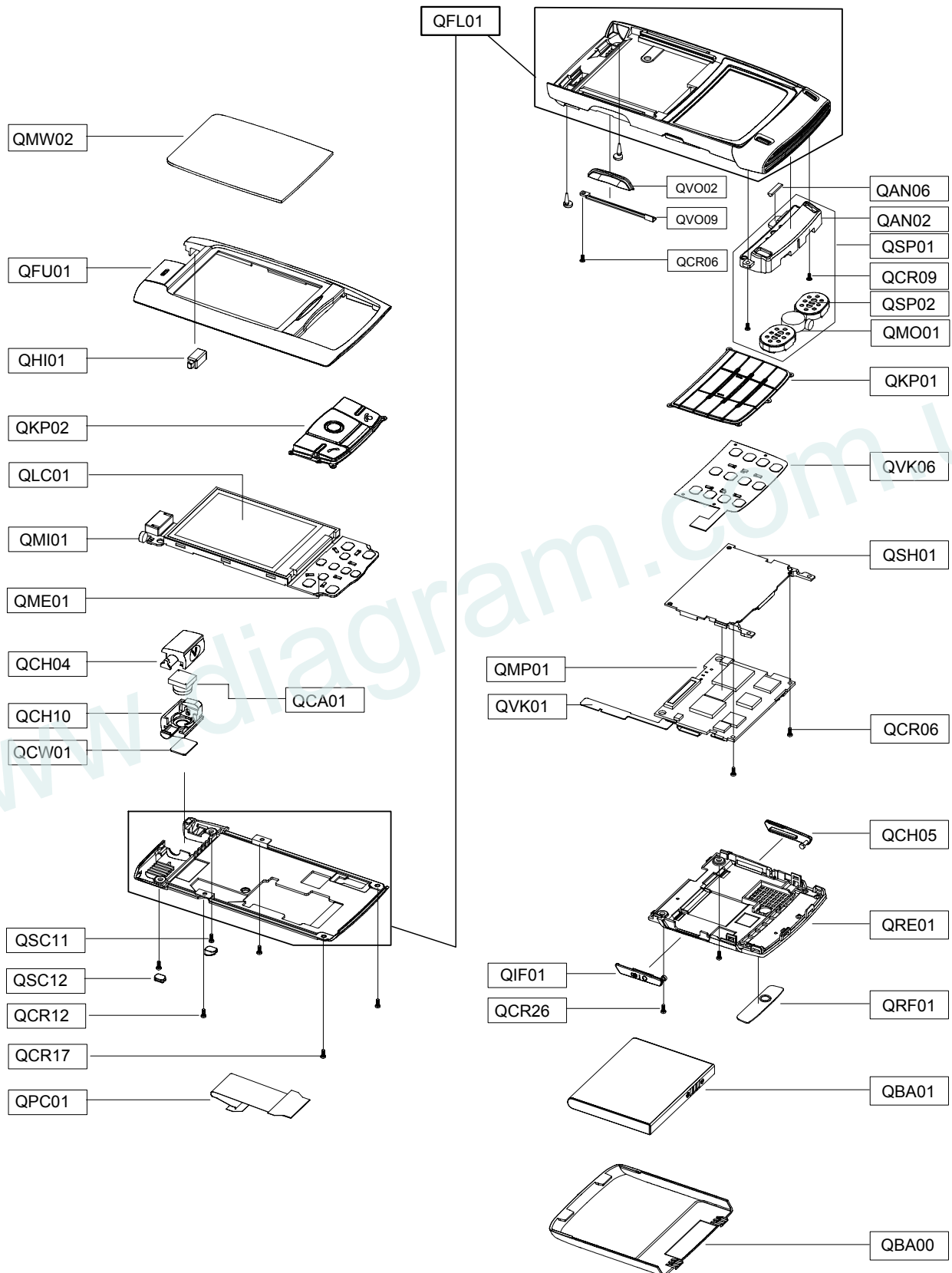

## 3-2. Parts List

Location NO.		Description	SEC CODE
QAN06		MEC-TAPE ANTENNA RUBBER	GH75-08483A
QAR01		AUDIO-RECEIVER	3009-001178
QBA00		MEC-BATTERY COVER	GH75-08553A
QBA01		INNER BATTERY PACK-800MAH,BLAC	GH43-02098A
QCA01		UNIT-CAMERA	GH59-02787B
QCH04		MEC-CAMERA UPPER	GH75-08984A
QCH10		MEC-CAMERA LOWER	GH75-08107A
QCR06		SCREW-MACHINE	6001-001155
QCR09		SCREW-MACHINE	6001-001670
QCR12		SCREW-MACHINE	6001-001530
QCR17		SCREW-MACHINE	6001-001460
QCR26		SCREW-MACHINE	6001-001850
QCW01		PCT-CAMERA WINDOW	GH72-25223A
QFL01		MEC-FRONT SLIDER LOWER	GH75-08922A
QFU01		MEC-SLIDER UPPER	GH75-09284A
QHI01		MEC-HINGE(CAMERA)	GH75-06936A
QKP01		MEC-KEYPAD MAIN(EU/IKA)	GH75-08928A
QKP02		MEC-KEYPAD SUB	GH75-08927A
QLC01		ELA ETC-SGHD820 SUB LCD ASSY	GH96-02105A
QME01		UNIT-METAL DOME(SUB)	GH59-02384A
QMI01		MICROPHONE-ASSY	GH30-00220A
QMP01		PBA MAIN-SGHD820	GH92-02534A
QMW02		PCT-MAIN WINDOW	GH72-25222A
QPC01		MEA-SLIDER FPCB KIT	GH97-05501A
QRF01		PMO-RF COVER	GH72-25131A
QSC11		PMO-S/LOWER SCREW CAP R	GH72-26494A
QSC12		PMO-S/LOWER SCREW CAP L	GH72-26493A
QSH01		MEC-SHIELD CAN	GH75-09439A
QVK01		UNIT-VOLUME KEY	GH59-02935A
QVK06		UNIT-KEYPAD FPCB(MAIN)	GH59-02379A
QVO02		PMO-KEY VOLUME	GH72-24204A
QVO09		NDC-VOLUME KEY COVER	GH71-05436A
QSP01		UNIT-SPK MOT INTENNA MODULE	GH59-02915A
	QAN02	ANTENNA-SGHD820	GH42-00767A
	QSP02	UNIT-MODULE SPEAKER	GH59-02851A
	QMO01	MOTOR DC-SGHT809	GH31-00196A
QRE01		MEC-REAR COVER	GH75-08929A
	QCH05	PMO-T FLASH COVER V3	GH72-26991A
	QIF01	PMO-IF COVER V4	GH72-26995A

<b>Description</b>	<b>SEC CODE</b>
BAG PE	6902-000297
BAG PE	6902-000378
CBF INTERFACE-AV CABLE	GH39-00442A
CBF INTERFACE-DATA LINK CABLE	GH39-00444A
ADAPTOR-SGHD800 TA(EU)	GH44-01060A
S/W CD-SAMSUNG PC STUDIO	GH46-00191A
UNIT-EARPHONE	GH59-02499A
LABEL(P)-IMEI	GH68-01335D
LABEL(P)-WATER SOAK	GH68-02026A
MANUAL-USER	GH68-08207A
LABEL(R)-SGHD820(EU)	GH68-08973A
BOX(P)-UNIT MAIN	GH69-03456A
BOX(P)-SLIP CASE(EU)	GH69-03553A
MPR-BOHO VINYL LCD CONN	GH74-15350A
MPR-TAPE MAIN WINDOW	GH74-17833A
MPR-TAPE SUB INSULATION	GH74-17843A
MPR-TAPE SUB INSULATION	GH74-17843A
MPR-TAPE MAIN CONNECTOR	GH74-17844A
MPR-TAPE RF COVER	GH74-17845A
MPR-TAPE EL FIXED	GH74-18873A
MPR-TAPE HOT BAR FIXED	GH74-18878A
MPR-BOHO VINYL INPUT BEF	GH74-18886A
MPR-BOHO VINYL INPUT AFT	GH74-18887A
MPR-TAPE VOLKEY SOLDER	GH74-18904A
MPR-BOHO VINYL KEYPAD	GH74-19130A
MPR-BOHO VINYL M/KEYPAD	GH74-19246A
MPR-TAPE SUB MIC SOLDER	GH74-19264A
MPR-TAPE LCD FPVB SUB 2	GH74-21187A
MPR-TAPE LCD FPCB MAIN 1	GH74-21189A
MPR-VINYL BOHO MAIN WIN FINAL	GH74-21556A
MPR-TAPE LCD ESD 1	GH74-21557A
MPR-TAPE LCD ESD 2	GH74-21558A
MPR-TAPE SUB CONNECTOR 2	GH74-21559A
MPR-TAPE LCD HOT BAR 2	GH74-21560A
MPR-GASKET MAIN CONN 2	GH74-22079A
MPR-VINYL BOHO WIN DUST	GH74-22082A
MPR-TAPE EMI 1	GH74-22084A

### 3-3. Disassembling Procedure

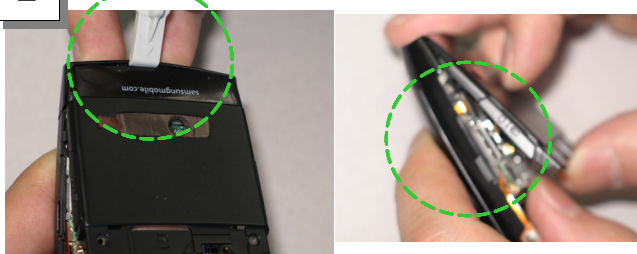
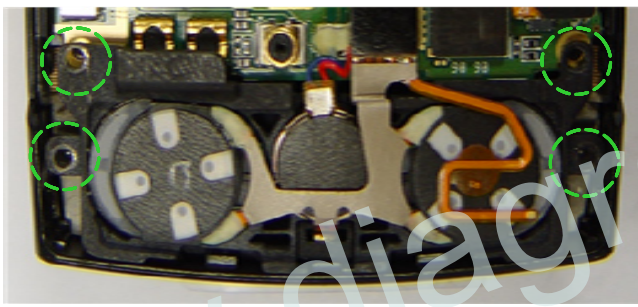
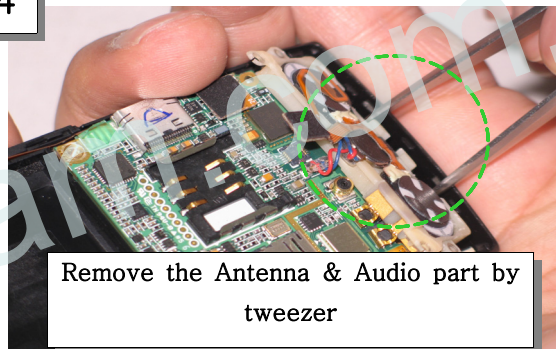
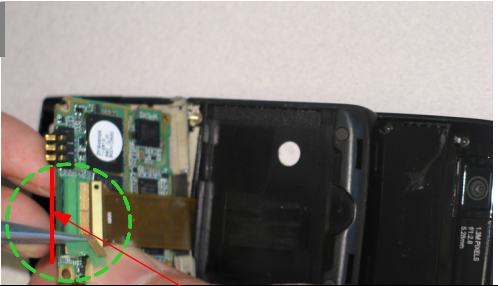
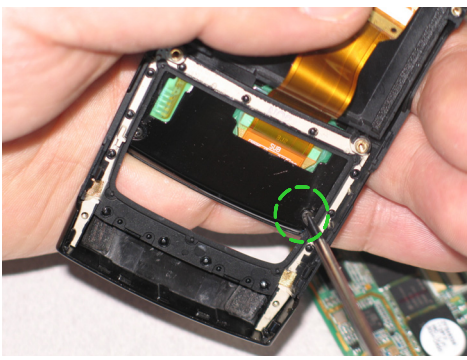
<p>1</p> 	<p>2</p>  <p>Open the rear case with your finger</p> <p>Put the disassembly tool on lower end of rear case</p>
<p><b>Remove the 3 screws on rear case &amp; Volume Key</b></p>	<p><b>Do not disassemble the phone by compulsion</b></p>
<p>3</p> 	<p>4</p>  <p>Remove the Antenna &amp; Audio part by tweezers</p>
<p><b>Remove the 4 screws on Antenna &amp; Audio Parts</b></p>	<p><b>When remove the Antenna part, make ensure the Vibrator part carefully</b></p>
<p>5</p>  <p>When you remove the FPCB, you must pull up the actuator</p>	<p>6</p> 
<p><b>Slide up then remove the green tape</b></p>	<p><b>Remove the Main PCB and Key pad then remove the 2 screws</b></p>

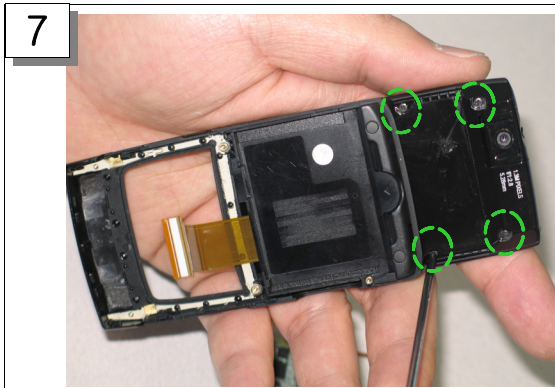

7

**Make a Slide up, then remove the 4 screws**



8

**Disassemble the Slide Part**

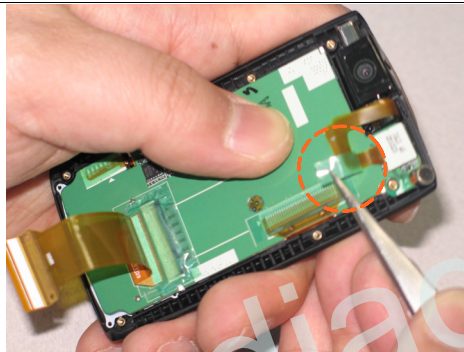

9

**Before disassemble the Camera part, remove the green tape**



10

Remove the green tape then remove the FPCB

**When you remove the FPCB, first pull up the actuator then removethe FPCB**

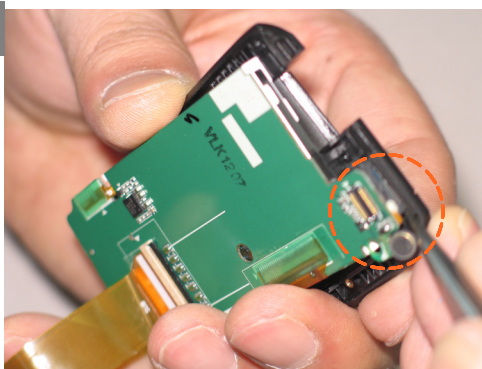

11

**Before disassemble the slider PCB, remove the Receiver part**

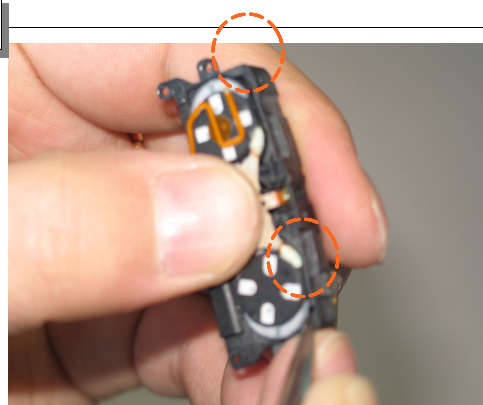

12

**When you remove the audio part, using a removal hole by tweezor**



13



**When you disassemble the slide part, push the slide part to the upper end**

www.diagram.com.ua

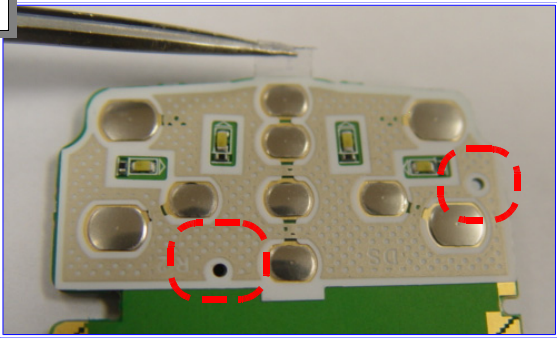
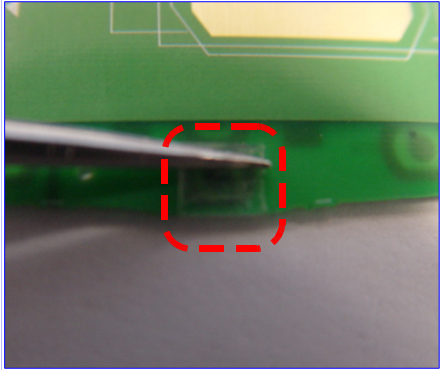
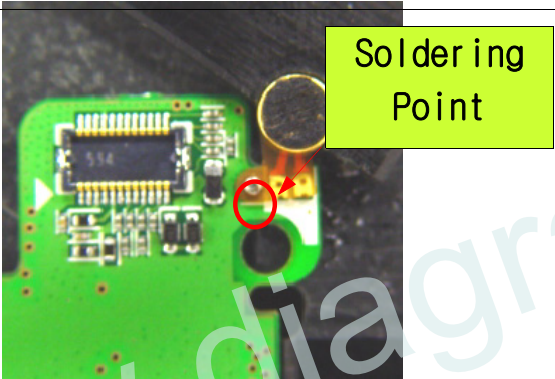
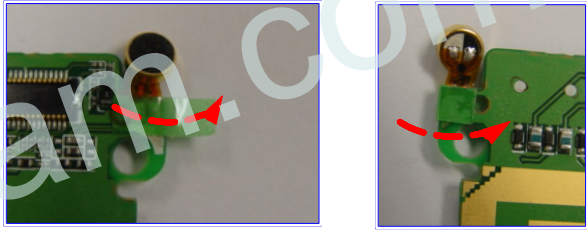
### 3-4. Assembling Procedure

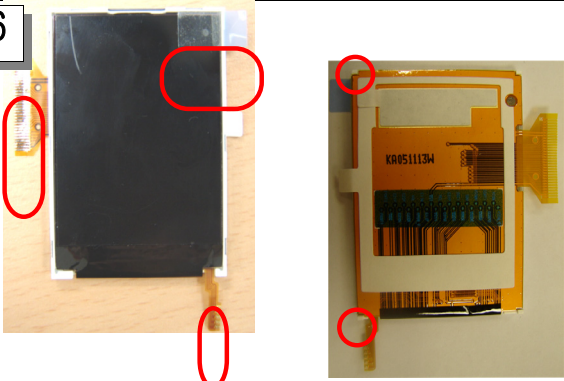
<p>1</p> 	<p>2</p> 
<p><b>Check the guide holes for dome sheet</b></p>	<p><b>The lower part of dome sheet should be attached on the rear side of PCB</b></p>
<p>3</p> 	<p>4</p> 
<p><b>Solder the sub_microphone guided by it's soldering point</b></p>	<p><b>Adhere the non-conductive tape on the soldering point of SUB_MIC</b></p>
<p>5</p> 	<p>6</p> 
<p><b>Check the guide hole on right position</b></p>	<p><b>Check the Hot Bar, Backlight FPCB, Heat seal and Guide poles</b></p>

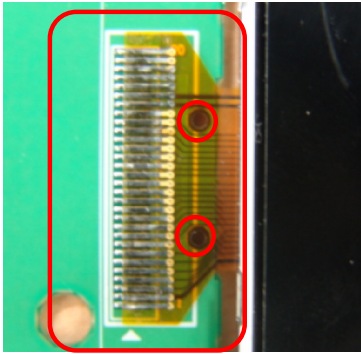
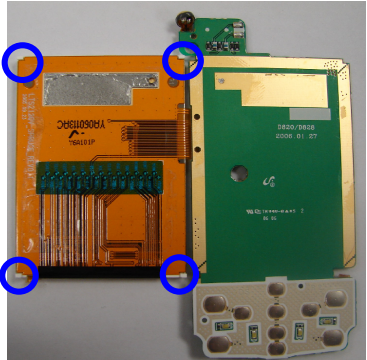

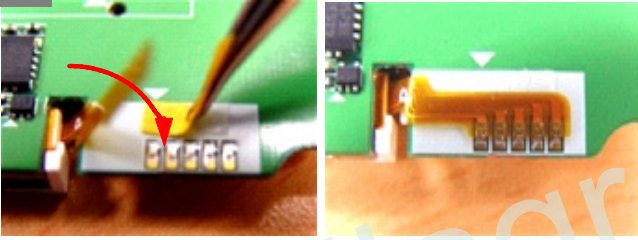
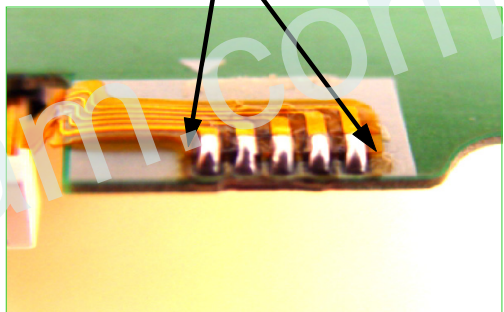
<p>7</p> 	<p>8</p> 
<p><b>Check the guide hole on right position</b></p>	<p><b>Adjust between each corners of LCD module and Guiding edges on PCB</b></p>

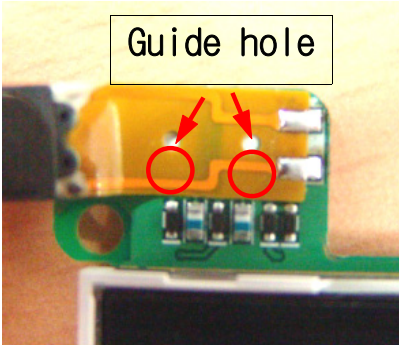
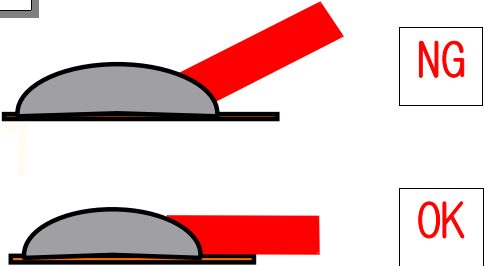
<p>9</p> 	<p>10</p> <p>GUIDE MARK</p> 
<p><b>Solder the backlight FPCB</b></p>	<p><b>Be careful of two guide marks on soldering process</b></p>



<p>11</p> <p>Guide hole</p> 	<p>12</p> 
<p><b>Solder the Receiver on PCB</b></p>	<p><b>Receiver's FPCB should be parallel to the PCB</b></p>

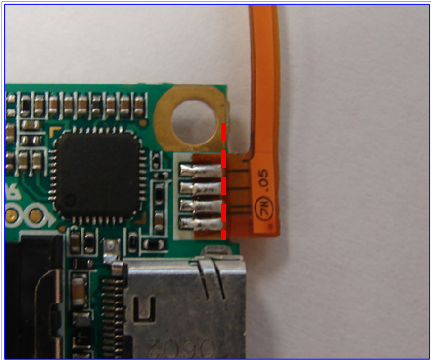
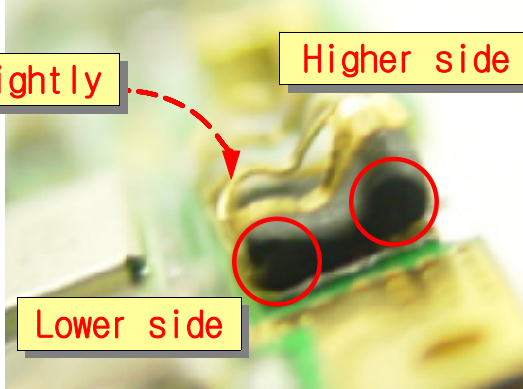
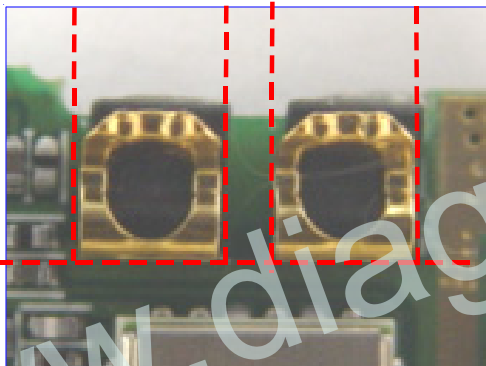

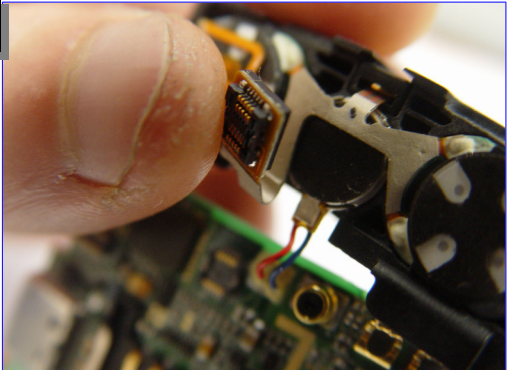
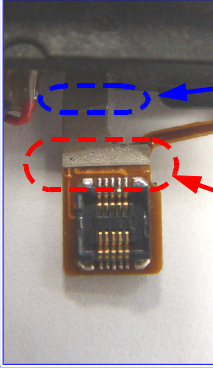
<p>13</p> 	<p>14</p> 
<p><b>Adhere the non-conductive tape on left side of PCB</b></p>	<p><b>Adhere the non-conductive tape on the charger pump</b></p>
<p>15</p> 	<p>16</p> 
<p><b>Adhere the non-conductive tape on Hot-bar</b></p>	<p><b>Adhere the non-conductive tape on backlight FPCB</b></p>
<p>17</p> 	<p>18</p> 
<p><b>Solder and bond the vibrator's wire and bend it on picture's direction</b></p>	<p><b>Paste the Bluetooth Ant. on the right side Speaker</b></p>

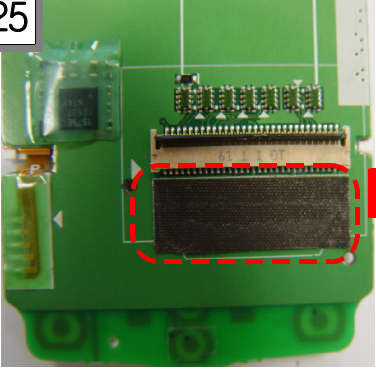
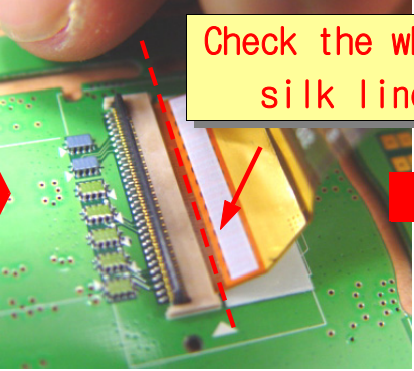
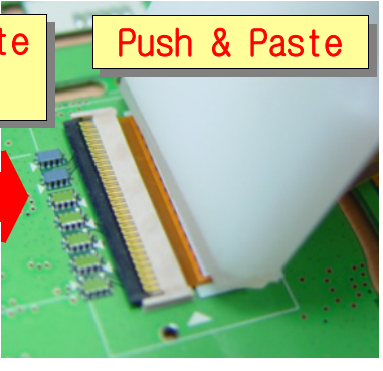
<p>19</p> 	<p>20</p> 
<p><b>Solder the side key FPCB. Adjust the PCB outline and be careful of electrical shortage.</b></p>	<p><b>Insert the rubber for intenna contact</b></p>
<p>21</p> 	<p>22</p> 
<p><b>Rubber should be place on aligned position on the red line</b></p>	<p><b>Adhere the non-conductive tape on the solder point of side key</b></p>
<p>23</p> 	<p>24</p>  <p>Bending point of FPCB (the form of 'U')</p> <p>This point should not be bended</p>
<p><b>Bend the SPK FPCB</b></p>	<p><b>The bending point of SPK FPCB</b></p>

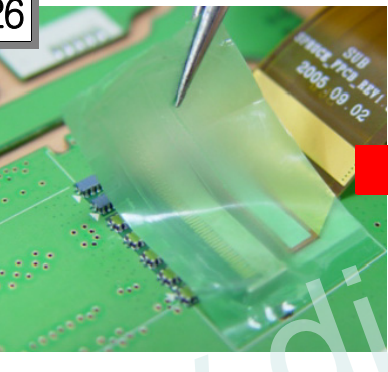
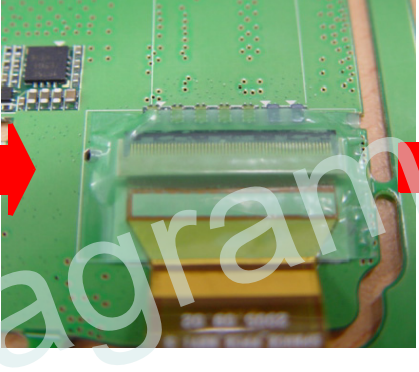
<p>25</p> 	 <p>Check the white silk line</p>	 <p>Push &amp; Paste</p>
<p><b>Remove the protection cover</b></p>	<p><b>Check the alignment between FPCB and white silk line</b></p>	

<p>26</p> 		
<p><b>Adhere the non-conductive tape on FPCB connector of Sub PCB</b></p>	<p><b>Check the alignment between FPCB and white silk line</b></p>	

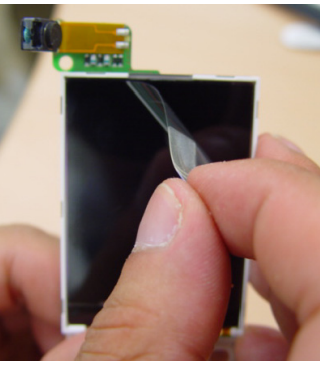
<p>27</p> 	<p>28</p> 
<p><b>Put the Sub Key Pad on the slide upper case</b></p>	<p><b>Remove the protection tape on LCD window</b></p>

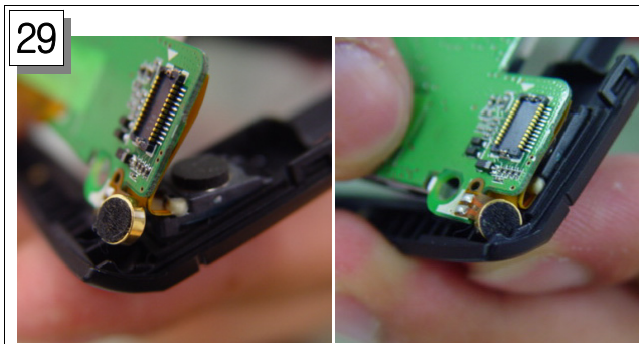

**Insert the receiver and Sub MIC into each holder on the slide upper case**

from '2' to '1' direction

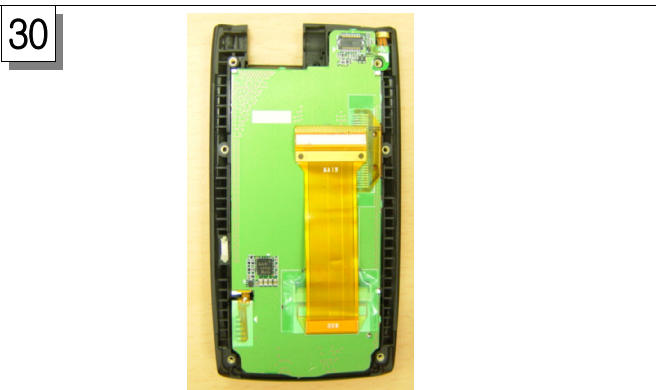

**Put the sub PBA assy. on the slide upper case**

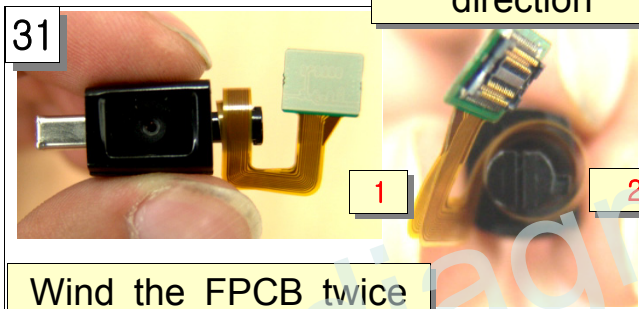

Wind the FPCB twice

**Wind the camera's FPCB on the its hinge**

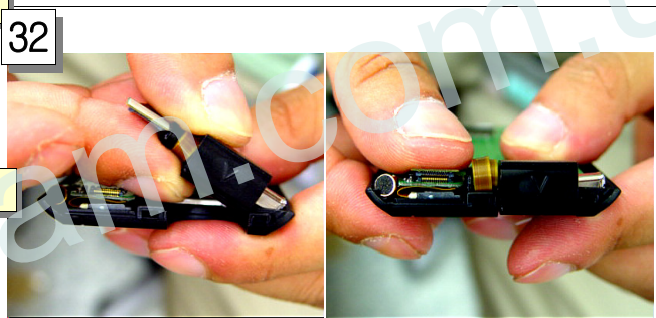

**Insert the camera module on the fron case (put on the camera's hinge first)**

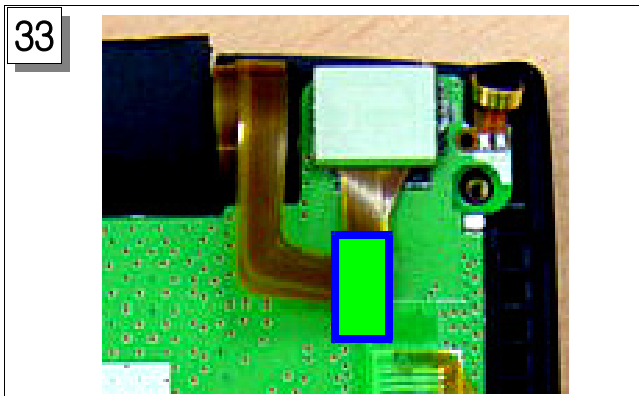

**Adhere the non-conductive tape on the cameras FPCB**

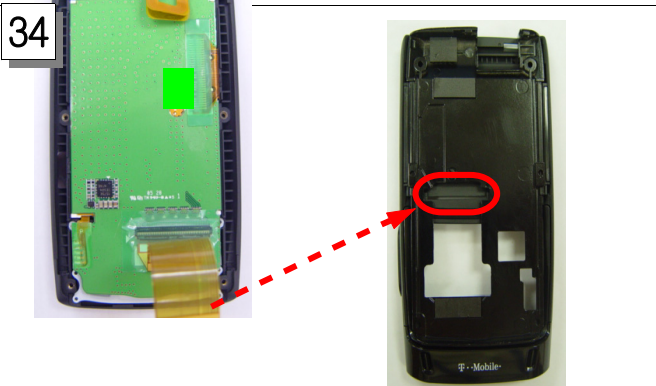

**Pull out the Main FPCB through the slider case's hole(red circle)**

35

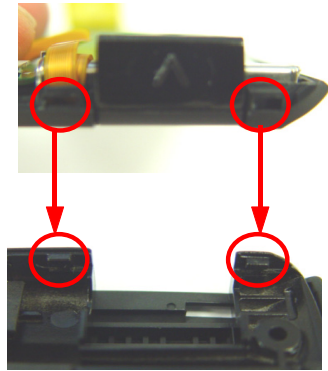

**Push the slide lower to the slide upper's direction**

36



**If there is no problems until now, the current state will be like this**

37



**Screw down the upper's 4 points**

38



**Screw down the lower's 2 points**

39

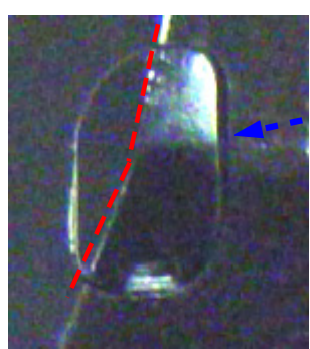

**Insert the screw cap**

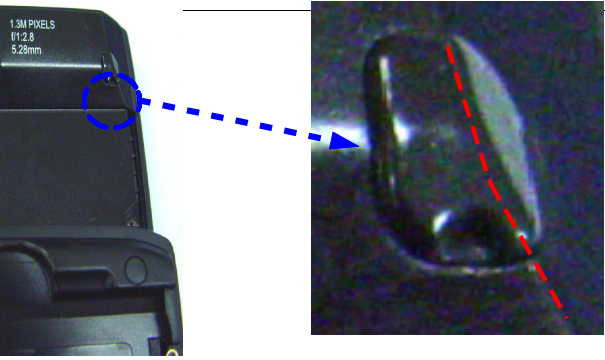

**Be careful of each direction**

40 MAIN KEY PAD'S GUIDE HOLE

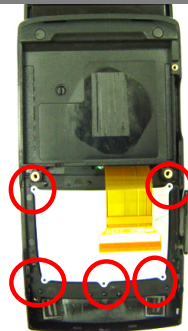

Put the main key pad on the front case

41

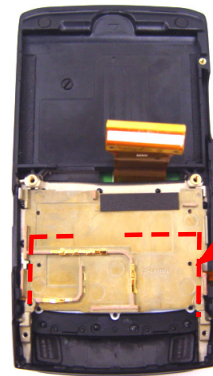

shield can's guide line

Place the shield can over the main key pad

42

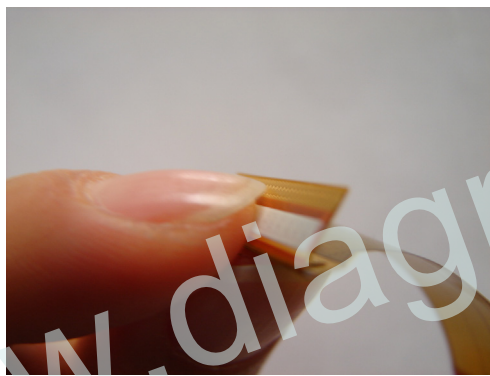

Confirm the bending state of Main FPCB

43

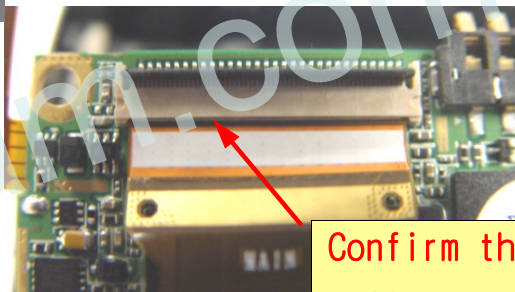

Confirm the alignment

Push the main FPCB into the Main connector

44

Push the whole parts of FPCB equaly

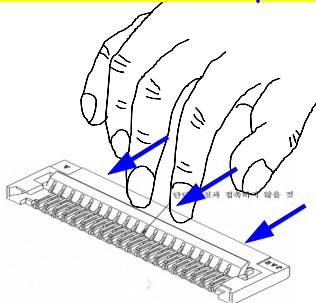

Insertion guide

45

Push the middle of actuator first and the both sides later

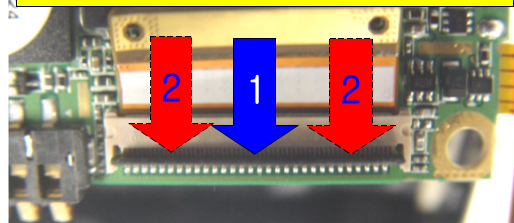

Insertion guide II ;

46

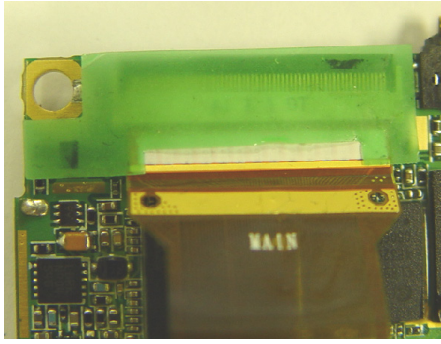

**Adhere the non-conductive tape on the Main connector of Main PCB**

47

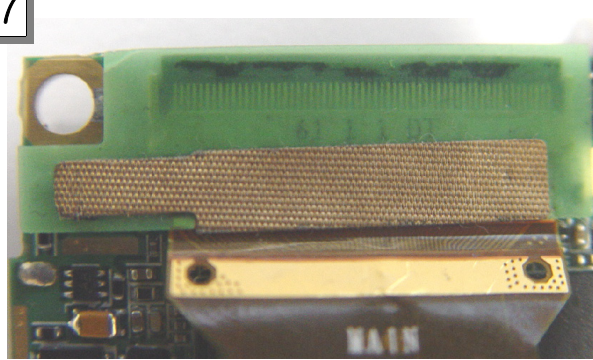

**Adhere the gold gasket over the non-conductive tape**

48



**Bending line should be aligned with the red line**

49



**If the other point is bent, the critical display error will be occurred**

50

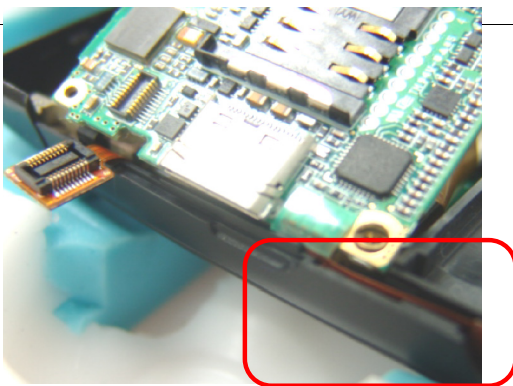

**Bend and push the side key FPCB into the front case**

51

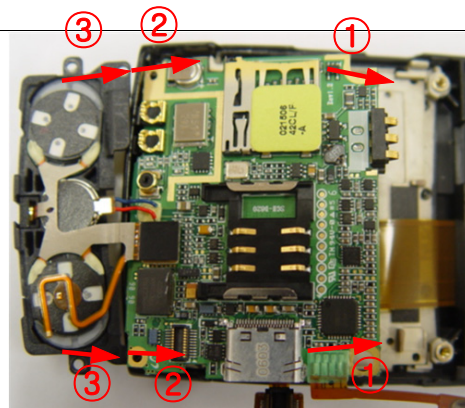

**Put the Main PCB on the shield can in the order described above**

52

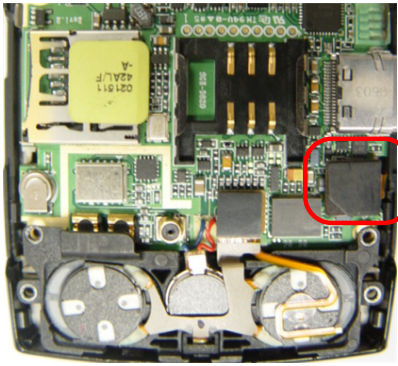

Insert the shield can's connector

53

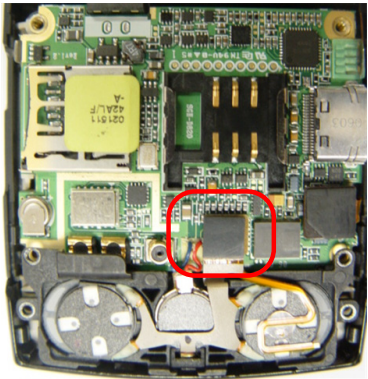

Insert the Speaker's connector

54

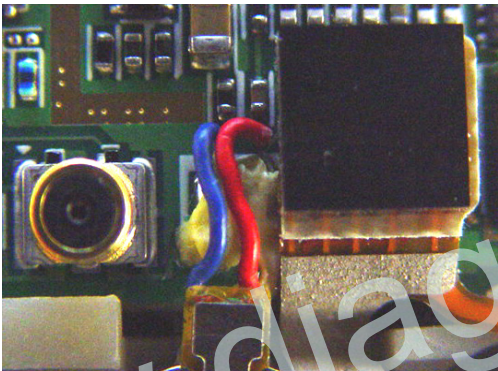

Reference position of the vibrator's wire

55

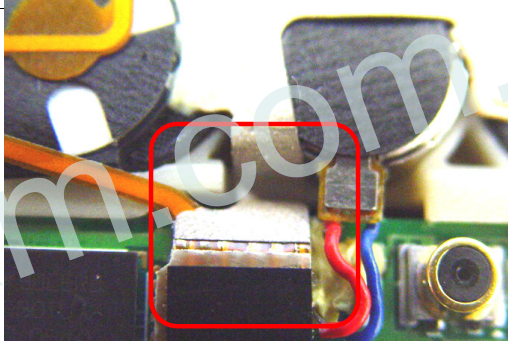

Bend as the form of 'U' and push the SPK's FPCB into the inner space

56

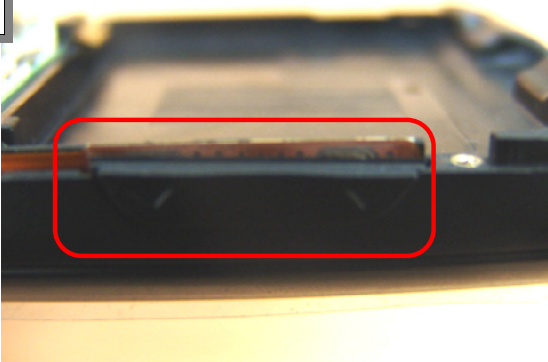

The picture of side key FPCB on normal condition

57

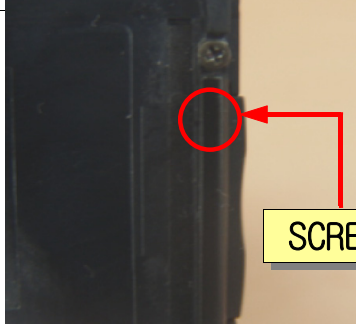

SCREW

Screw down the side key's holder



58

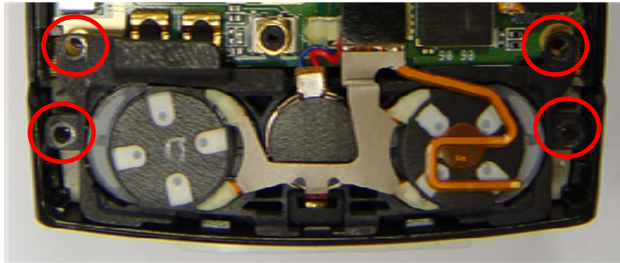

**Screw down on each 4 points of antenna module**

59

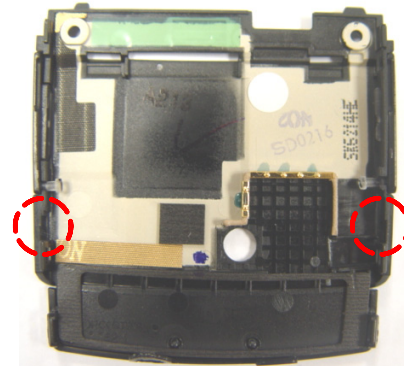

**Two red circles' point should be inserted first at the rear case assembly procedure**

60

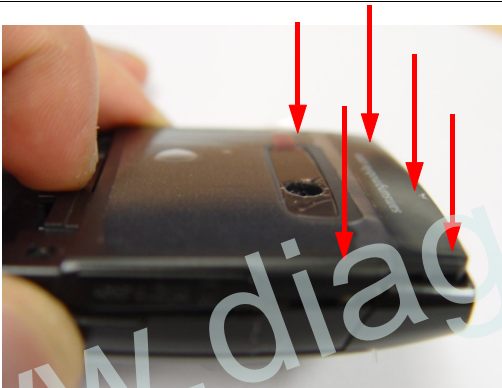

**Push each 5 points sufficiently**

61



**Screw down on the last 2 points**

### 3-5. Slide FPCB KIT Assembling Procedure

- Sub PCB Part

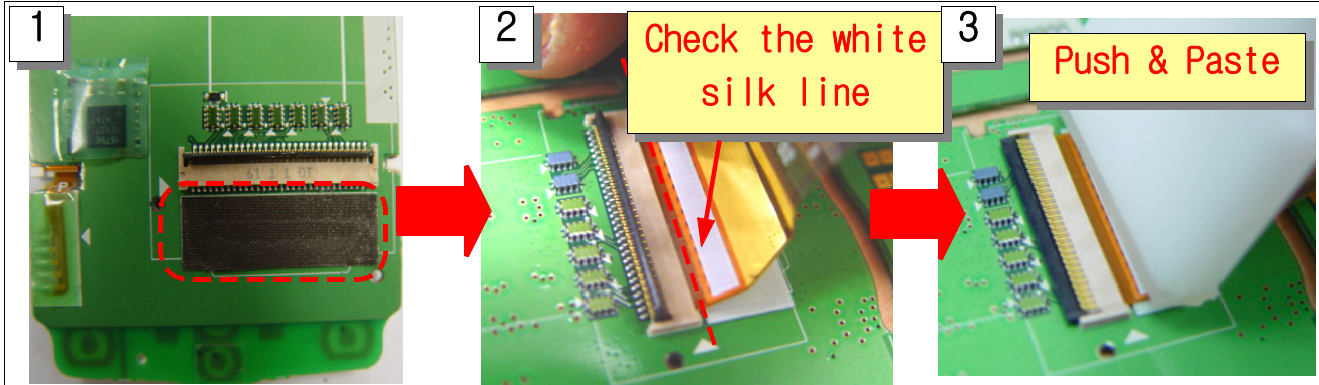

1. Check the condition of FPCB and remove the protection cover of Sub PCB
2. Check the alignment between FPCB and white silk line
3. Push and Paste evenly by pushing tool

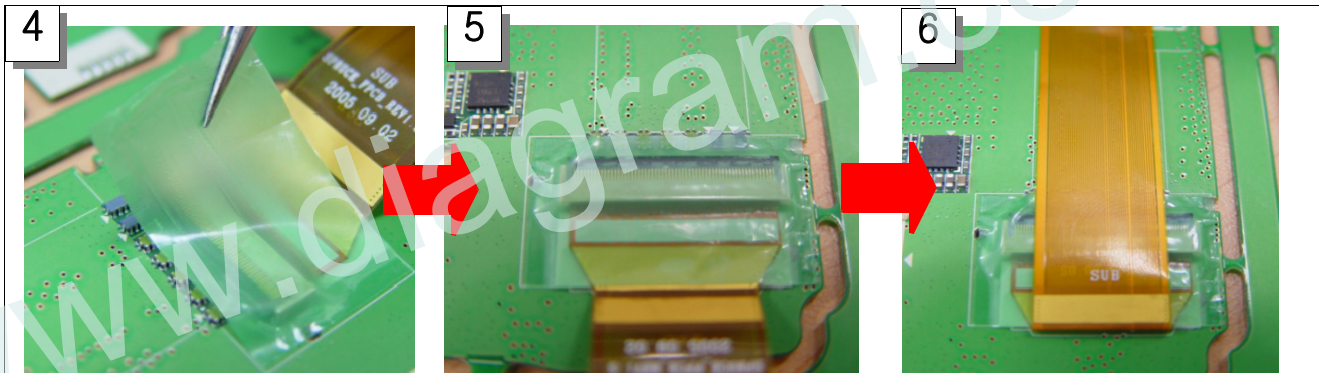

4. Adhere the non-conductive tape on FPCB connector of Sub PCB
5. Check the condition of attachment
6. Bend the FPCB upward and check the alignment between FPCB and white silk line

- Main PCB Part

7

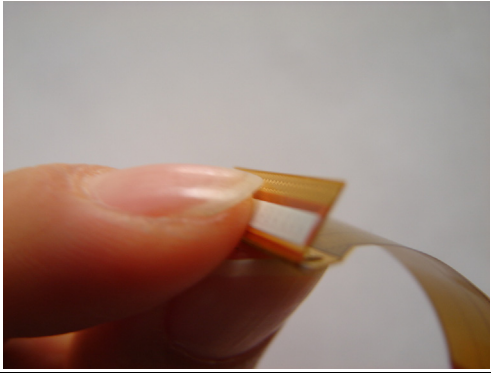

**Confirm the bending state of FPCB**

8



**Remove the protection cover**

9

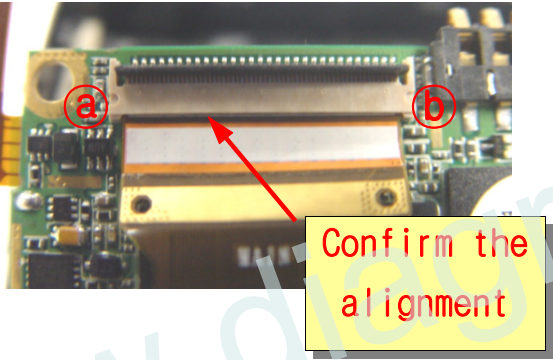

**Push the main FPCB into the Main connector and confirm the alignment with (a)-(b) line**

10

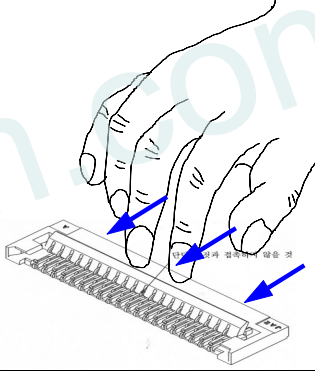

**Push the whole parts of FPCB equally**

11

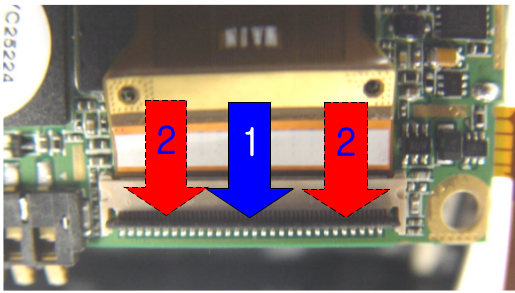

**Push the middle of actuator first and the both sides later**

12

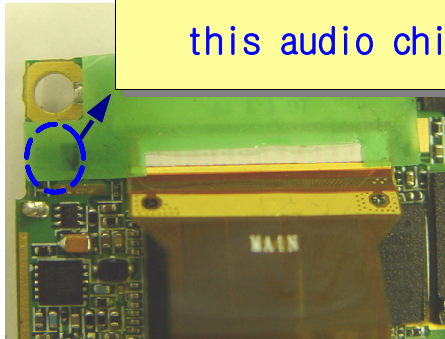

**Adhere the non-conductive tape on the Main connector of Main PCB**

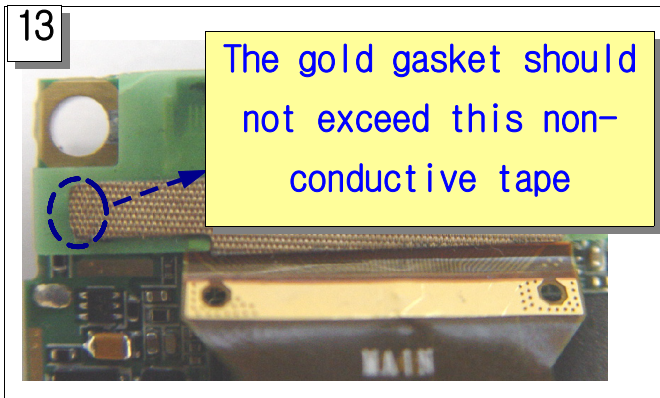

**Adhere the gold gasket over the non-conductive tape**

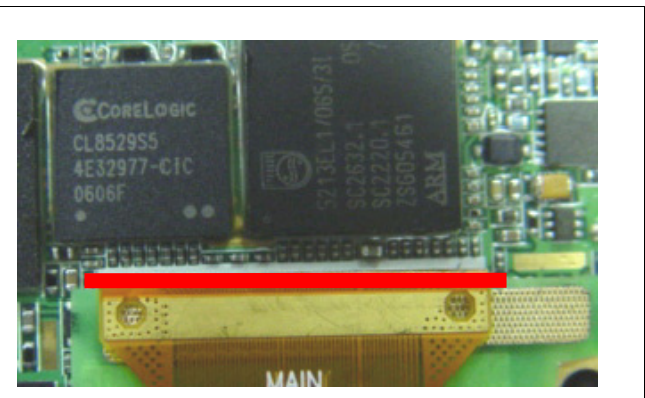

**Bending line should be aligned with the red line**

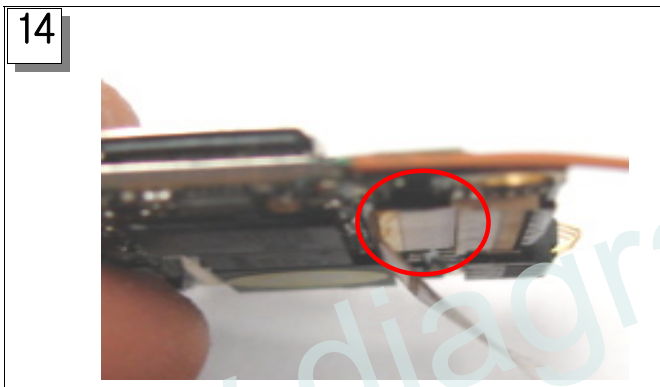



**Important :**  
**If the other point is bent, the critical display error will be occurred**

### 3-6. LCD KIT Assembling Procedure

<p><b>Check the (1)Hot Bar, (3) Backlight FPCB, (2) Heat seal and (4)Guide poles</b></p>	<ol style="list-style-type: none"> <li><b>1. Remove the double-sided tape on Sub PCB by tweezer.</b></li> <li><b>2. Align the guide holes on hot bar FPCB with guide silk on Sub PCB.</b></li> <li><b>3. Paste the flux evenly on the solder PAD .</b></li> <li><b>4. Solder by the soldering iron</b></li> <li><b>5. Check the soldered condition</b></li> </ol>

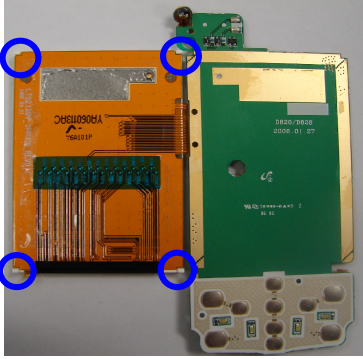
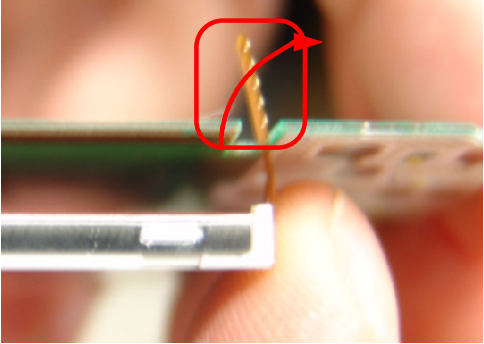
<p><b>Check the condition of HOT BAR by a magnifying glass</b></p>	

<p><b>4</b></p> 	<p><b>5</b></p> 
<ol style="list-style-type: none"> <li>1. Remove the double-sided tape on bottom side of LCD by tweezers</li> <li>2. Adjust between each corner of LCD module and Guiding edges on PCB</li> <li>3. Pay attention the Hot bar not to be bent when you remove the tape by tweezers</li> </ol>	<ol style="list-style-type: none"> <li>1. Attach the LCD module after inserting the back light FPCB first</li> <li>2. LCD module should be attached closely on Sub PCB</li> <li>3. Check the LCD's GUIDE POLE fitting on the guide groove on Sub PCB</li> </ol>

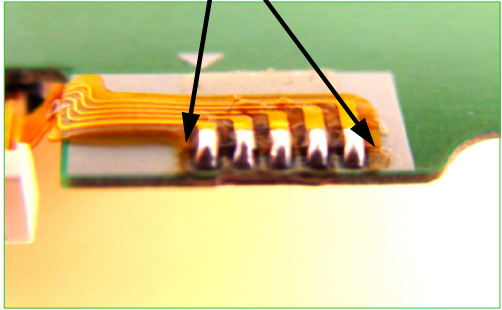
<p><b>6</b></p> 	<p><b>7</b></p> <p>GUIDE MARK</p> 
<ol style="list-style-type: none"> <li>1. Remove the cover of double-sided tape beside the soldering pad by tweezers</li> <li>2. Adjust the end of Backlight FPCB's Land with the guide mark on PCB</li> <li>3. Paste the flux on the solder land</li> </ol>	<ol style="list-style-type: none"> <li>1. Pay attention the backlight FPCB not to be cracked</li> <li>2. Do not paste the Flux too much</li> <li>3. Be careful of two guide marks on soldering process</li> </ol>

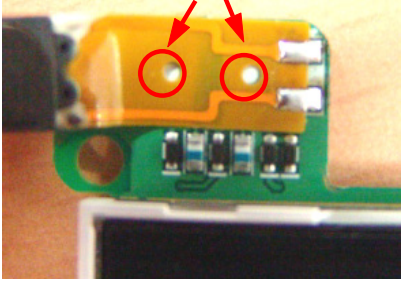
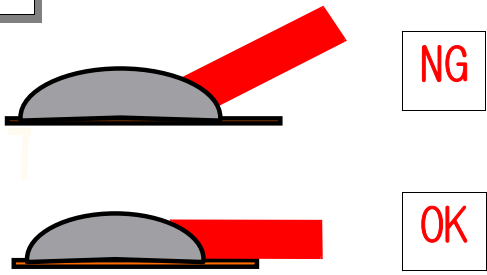
<p><b>8</b></p> <p>Check the Guide hole</p> 	<p><b>9</b></p> 
<p>1. Solder the Receiver (Temp. recommend : 350℃ ~ 380℃) 2. Soldering time : within 3 sec.</p>	<p>1. Check the soldered position 2. Check the short/open condition</p>

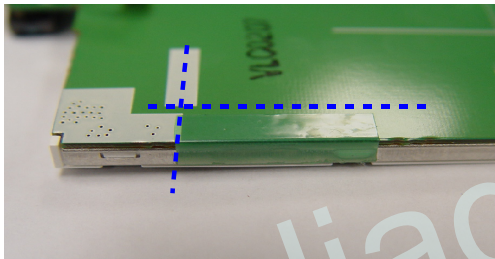
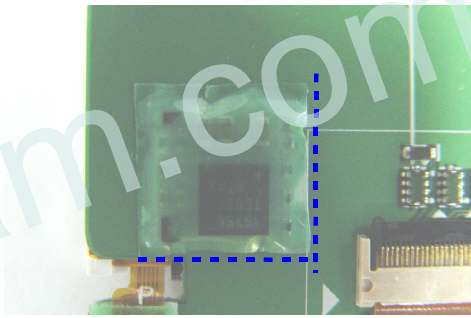
<p><b>10</b></p> 	<p><b>11</b></p> 
<p><b>Adhere the non-conductive tape on left side of PCB</b></p>	<p><b>Adhere the non-conductive tape on the charger pump</b></p>

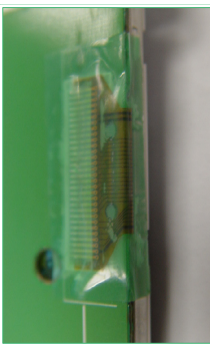
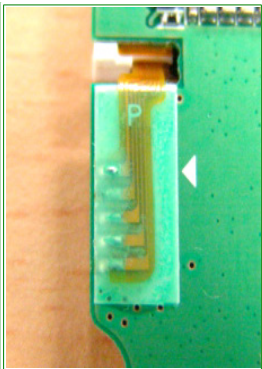
<p><b>12</b></p> 	<p><b>13</b></p> 
<p><b>Adhere the non-conductive tape on Hot-bar</b></p>	<p><b>Adhere the non-conductive tape on backlight FPCB</b></p>

3-7. Test Jig (GH80-03306A)

3-7-1. USB JIG Cable

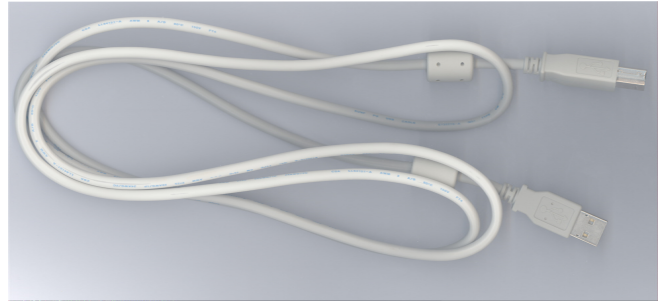
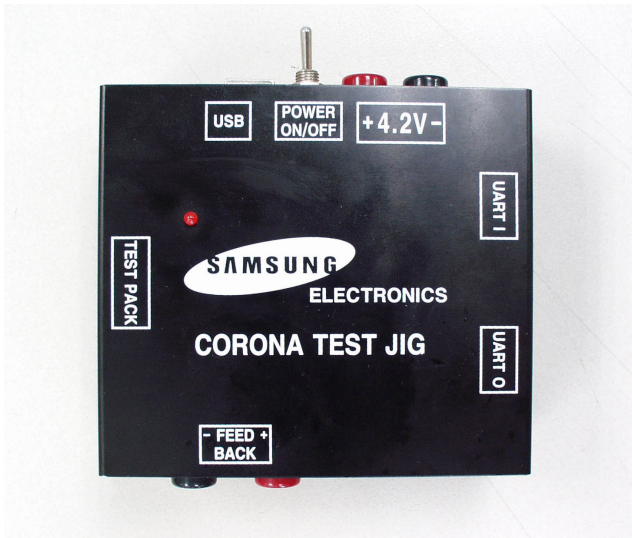

3-7-2. RF Test Cable  
(GH39-00397A)

3-7-3. Test Cable  
(GH39-00459A)

3-7-4. Serial Cable  
(CSA LL64151-A)

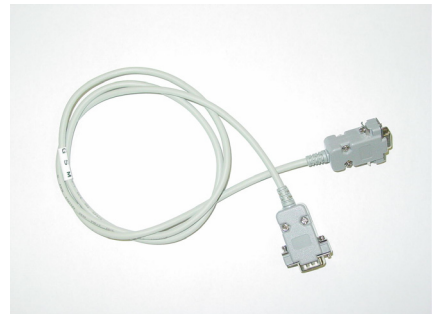

3-7-5. Power Supply Cable

3-7-6. DATA CABLE  
(GH39-00444A)

3-7-7. TA  
(GH44-01060A)

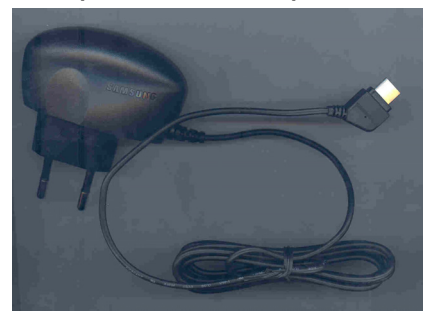
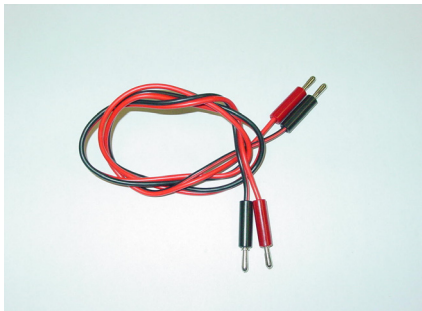



## 4. Electrical Parts List

DESIGN LOC	DESCRIPTION	SEC CODE	STATUS
ANT101	NPR-ANTENNA CONTACT	GH71-05796A	SA
ANT102	NPR-ANTENNA CONTACT	GH71-05796A	SA
BAT409	BATTERY-LI(2ND)	4302-001181	SA
BTC600	CONNECTOR-BATTERY	3711-006003	SA
C102	C-CER,CHIP	2203-003054	SA
C103	C-CER,CHIP	2203-001259	SA
C105	C-CER,CHIP	2203-000812	SA
C106	C-CER,CHIP	2203-000812	SA
C107	C-CER,CHIP	2203-000854	SA
C109	C-CER,CHIP	2203-001201	SA
C112	C-CER,CHIP	2203-000812	SA
C114	C-CER,CHIP	2203-000233	SA
C116	C-CER,CHIP	2203-002709	SA
C118	C-CER,CHIP	2203-000812	SA
C121	C-CER,CHIP	2203-000425	SA
C122	C-CER,CHIP	2203-000425	SA
C124	C-CER,CHIP	2203-000233	SA
C126	C-CER,CHIP	2203-002668	SA
C127	C-CER,CHIP	2203-006120	SA
C131	C-CER,CHIP	2203-006120	SA
C134	C-CER,CHIP	2203-000233	SA
C135	C-CER,CHIP	2203-000254	SA
C136	C-CER,CHIP	2203-000330	SA
C138	C-CER,CHIP	2203-000812	SA
C139	C-CER,CHIP	2203-000854	SA
C141	C-CER,CHIP	2203-000995	SA
C142	C-CER,CHIP	2203-000995	SA
C147	C-CER,CHIP	2203-002709	SA
C148	C-CER,CHIP	2203-000654	SA
C152	C-CER,CHIP	2203-000812	SA
C157	C-CER,CHIP	2203-000995	SA
C160	C-CER,CHIP	2203-005682	SA
C161	C-CER,CHIP	2203-005050	SA
C162	C-CER,CHIP	2203-005050	SA
C163	C-CER,CHIP	2203-000812	SA
C165	C-CER,CHIP	2203-000854	SA
C166	C-CER,CHIP	2203-000359	SA
C201	C-CER,CHIP	2203-006194	SA
C202	C-CER,CHIP	2203-006423	SA
C203	C-CER,CHIP	2203-006423	SA
C204	C-CER,CHIP	2203-006423	SA
C205	C-CER,CHIP	2203-006423	SA
C206	C-CER,CHIP	2203-006423	SA
C207	C-CER,CHIP	2203-006423	SA
C208	C-CER,CHIP	2203-006423	SA
C209	C-CER,CHIP	2203-006423	SA
C210	C-CER,CHIP	2203-006562	SA
C211	C-CER,CHIP	2203-006423	SA
C212	C-CER,CHIP	2203-006423	SA
C213	C-CER,CHIP	2203-006423	SA

Electrical Parts List

DESIGN LOC	DESCRIPTION	SEC CODE	STATUS
C218	C-CER,CHIP	2203-006048	SA
C219	C-CER,CHIP	2203-006423	SA
C221	C-CER,CHIP	2203-005682	SA
C301	C-CER,CHIP	2203-006048	SA
C302	C-CER,CHIP	2203-000254	SA
C303	C-CER,CHIP	2203-006423	SA
C304	C-CER,CHIP	2203-006423	SA
C305	C-CER,CHIP	2203-006423	SA
C306	C-CER,CHIP	2203-006423	SA
C307	C-CER,CHIP	2203-000330	SA
C308	C-CER,CHIP	2203-000330	SA
C309	C-CER,CHIP	2203-006048	SA
C317	C-CER,CHIP	2203-006562	SA
C318	C-CER,CHIP	2203-006562	SA
C319	C-CER,CHIP	2203-006838	SA
C320	C-CER,CHIP	2203-006562	SA
C321	C-CER,CHIP	2203-006562	SA
C325	C-CER,CHIP	2203-006048	SA
C326	C-CER,CHIP	2203-005659	SA
C328	C-TA,CHIP	2404-001240	SA
C329	C-TA,CHIP	2404-001088	SA
C330	C-CER,CHIP	2203-006562	SA
C331	C-CER,CHIP	2203-006562	SA
C350	C-CER,CHIP	2203-006324	SA
C401	C-CER,CHIP	2203-006562	SA
C402	C-CER,CHIP	2203-006838	SA
C403	C-CER,CHIP	2203-006824	SA
C405	C-CER,CHIP	2203-006048	SA
C406	C-CER,CHIP	2203-006257	SA
C407	C-CER,CHIP	2203-000550	SA
C408	C-CER,CHIP	2203-000550	SA
C411	C-CER,CHIP	2203-000812	SA
C412	C-CER,CHIP	2203-006824	SA
C413	C-CER,CHIP	2203-006257	SA
C414	C-CER,CHIP	2203-006824	SA
C415	C-CER,CHIP	2203-006257	SA
C418	C-CER,CHIP	2203-006824	SA
C419	C-CER,CHIP	2203-006048	SA
C422	C-CER,CHIP	2203-006824	SA
C423	C-CER,CHIP	2203-006824	SA
C424	C-CER,CHIP	2203-006257	SA
C425	C-CER,CHIP	2203-006257	SA
C426	C-CER,CHIP	2203-000233	SA
C429	C-CER,CHIP	2203-006257	SA
C430	C-CER,CHIP	2203-006708	SA
C501	C-CER,CHIP	2203-006048	SA
C504	C-CER,CHIP	2203-001412	SA
C505	C-CER,CHIP	2203-006048	SA
C508	C-CER,CHIP	2203-000278	SA
C509	C-CER,CHIP	2203-001437	SA

DESIGN LOC	DESCRIPTION	SEC CODE	STATUS
C511	C-CER,CHIP	2203-005050	SA
C512	C-CER,CHIP	2203-001259	SA
C514	C-CER,CHIP	2203-006048	SA
C516	C-CER,CHIP	2203-001437	SA
C518	C-CER,CHIP	2203-000278	SA
C519	C-CER,CHIP	2203-001153	SA
C520	C-CER,CHIP	2203-005281	SA
C521	C-CER,CHIP	2203-006048	SA
C522	C-CER,CHIP	2203-006648	SA
C538	C-CER,CHIP	2203-006562	SA
C539	C-CER,CHIP	2203-005344	SA
C541	C-CER,CHIP	2203-006047	SA
C542	C-CER,CHIP	2203-005344	SA
C544	C-CER,CHIP	2203-005481	SA
C545	C-CER,CHIP	2203-006047	SA
C546	C-CER,CHIP	2203-005481	SA
C550	R-CHIP	2007-000148	SA
C551	R-CHIP	2007-000148	SA
C552	R-CHIP	2007-000148	SA
C553	R-CHIP	2007-000148	SA
C554	C-CER,CHIP	2203-005344	SA
C555	C-CER,CHIP	2203-006562	SA
C556	C-CER,CHIP	2203-006048	SA
C558	C-CER,CHIP	2203-006562	SA
C559	C-CER,CHIP	2203-005344	SA
C563	C-CER,CHIP	2203-000854	SA
C564	C-CER,CHIP	2203-003054	SA
C566	C-CER,CHIP	2203-006048	SA
C567	C-CER,CHIP	2203-000812	SA
C568	C-CER,CHIP	2203-000812	SA
C569	C-CER,CHIP	2203-000627	SNA
C570	C-CER,CHIP	2203-000627	SNA
C571	C-CER,CHIP	2203-000386	SA
C600	C-CER,CHIP	2203-005779	SA
C601	C-CER,CHIP	2203-006562	SA
C602	C-CER,CHIP	2203-006626	SA
C604	C-CER,CHIP	2203-006048	SA
C605	C-CER,CHIP	2203-006048	SA
C606	C-CER,CHIP	2203-006048	SA
C607	C-CER,CHIP	2203-002443	SA
C608	C-CER,CHIP	2203-006562	SA
C609	C-CER,CHIP	2203-006562	SA
C610	C-CER,CHIP	2203-006048	SA
C611	C-CER,CHIP	2203-006048	SA
C613	C-CER,CHIP	2203-006562	SA
C615	C-CER,CHIP	2203-006838	SA
C617	C-CER,CHIP	2203-006562	SA
C618	C-CER,CHIP	2203-006562	SA
C620	C-CER,CHIP	2203-006048	SA
C621	C-CER,CHIP	2203-006324	SA

Electrical Parts List

DESIGN LOC	DESCRIPTION	SEC CODE	STATUS
C622	C-CER,CHIP	2203-002487	SA
C623	C-CER,CHIP	2203-006048	SA
C624	C-CER,CHIP	2203-006048	SA
C630	C-CER,CHIP	2203-002709	SA
C705	C-CER,CHIP	2203-005682	SA
C706	C-CER,CHIP	2203-005682	SA
C707	C-CER,CHIP	2203-005682	SA
C708	C-CER,CHIP	2203-005682	SA
C709	C-CER,CHIP	2203-005682	SA
C712	C-CER,CHIP	2203-006562	SA
C713	C-CER,CHIP	2203-005682	SA
C730	C-CER,CHIP	2203-005682	SA
C731	C-CER,CHIP	2203-005682	SA
C732	C-CER,CHIP	2203-005682	SA
C733	C-CER,CHIP	2203-006423	SA
C736	C-CER,CHIP	2203-005682	SA
C738	C-CER,CHIP	2203-005682	SA
C751	C-CER,CHIP	2203-006361	SA
C752	C-CER,CHIP	2203-006562	SA
C753	C-CER,CHIP	2203-006562	SA
C754	C-CER,CHIP	2203-006838	SA
C755	C-CER,CHIP	2203-006048	SA
C756	C-CER,CHIP	2203-005682	SA
C757	C-CER,CHIP	2203-005682	SA
C758	C-CER,CHIP	2203-005682	SA
C759	C-CER,CHIP	2203-005682	SA
C760	C-CER,CHIP	2203-005682	SA
C762	C-CER,CHIP	2203-005682	SA
C763	C-CER,CHIP	2203-005682	SA
C764	C-CER,CHIP	2203-005682	SA
C765	C-CER,CHIP	2203-005682	SA
C766	C-CER,CHIP	2203-005682	SA
C767	C-CER,CHIP	2203-005682	SA
C768	C-CER,CHIP	2203-005682	SA
C769	C-CER,CHIP	2203-005682	SA
C770	C-CER,CHIP	2203-005682	SA
C771	C-CER,CHIP	2203-006562	SA
C772	C-CER,CHIP	2203-005682	SA
C773	C-CER,CHIP	2203-005682	SA
C774	C-CER,CHIP	2203-005682	SA
C775	C-CER,CHIP	2203-005682	SA
C776	C-CER,CHIP	2203-005682	SA
C780	C-CER,CHIP	2203-005682	SA
C781	C-CER,CHIP	2203-005682	SA
C808	C-CER,CHIP	2203-006824	SA
C809	C-CER,CHIP	2203-006824	SA
C810	C-CER,CHIP	2203-006562	SA
C814	C-CER,CHIP	2203-006048	SA
C830	C-CER,CHIP	2203-006824	SA
C832	C-CER,CHIP	2203-005682	SA

DESIGN LOC	DESCRIPTION	SEC CODE	STATUS
C833	C-CER,CHIP	2203-005682	SA
C834	C-CER,CHIP	2203-005682	SA
C835	C-CER,CHIP	2203-005682	SA
C836	C-CER,CHIP	2203-005682	SA
C837	C-CER,CHIP	2203-005682	SA
C838	C-CER,CHIP	2203-005682	SA
C839	C-CER,CHIP	2203-005682	SA
C840	C-CER,CHIP	2203-005682	SA
C841	C-CER,CHIP	2203-005682	SA
C843	C-CER,CHIP	2203-005682	SA
C845	C-CER,CHIP	2203-006423	SA
C846	C-CER,CHIP	2203-006423	SA
C848	C-CER,CHIP	2203-006562	SA
C849	C-CER,CHIP	2203-006562	SA
C850	C-CER,CHIP	2203-006562	SA
C851	C-CER,CHIP	2203-006562	SA
C853	C-CER,CHIP	2203-006562	SA
C854	C-CER,CHIP	2203-006838	SA
C856	C-CER,CHIP	2203-001259	SA
C857	C-CER,CHIP	2203-000812	SA
CD300	CONNECTOR-CARD EDGE	3709-001344	SA
CPL308	BLUETOOTH MODULE	4709-001382	SA
D309	DIODE-TVS	0406-001200	SA
D403	DIODE-SCHOTTKY	0404-001172	SA
D500	DIODE-SCHOTTKY	0404-001172	SA
D516	DIODE-TVS	0406-001208	SA
D517	DIODE-TVS	0406-001150	SA
D813	DIODE-TVS	0406-001203	SA
D814	DIODE-TVS	0406-001203	SA
D815	DIODE-TVS	0406-001203	SA
D816	DIODE-TVS	0406-001203	SA
D817	DIODE-TVS	0406-001201	SA
F101	DUPLEXER-FEM	2911-000023	SA
F102	DUPLEXER-SAW	2911-000026	SA
F103	FILTER-EMI SMD	2901-001254	SA
F500	FILTER-EMI/ESD	2901-001322	SA
F600	FILTER-EMI SMD	2901-001254	SA
F800	FILTER-EMI/ESD	2901-001353	SA
F801	FILTER-EMI/ESD	2901-001353	SA
F802	FILTER-EMI/ESD	2901-001353	SA
F803	FILTER-EMI/ESD	2901-001353	SA
F804	FILTER-EMI/ESD	2901-001353	SA
F805	FILTER-EMI/ESD	2901-001353	SA
F806	FILTER-EMI/ESD	2901-001353	SA
HDC704	HEADER-BOARD TO BOARD	3711-005550	SA
HDC710	HEADER-BOARD TO BOARD	3711-005456	SA
HDC802	HEADER-BOARD TO BOARD	3711-005643	SA
IFC500	SOCKET-INTERFACE	3710-002306	SA
L101	INDUCTOR-SMD	2703-002597	SA
L103	R-CHIP	2007-000171	SA

Electrical Parts List

DESIGN LOC	DESCRIPTION	SEC CODE	STATUS
L106	INDUCTOR-SMD	2703-002636	SA
L117	INDUCTOR-SMD	2703-001990	SA
L121	INDUCTOR-SMD	2703-001868	SA
L133	INDUCTOR-SMD	2703-001409	SA
L135	INDUCTOR-SMD	2703-001178	SA
L137	INDUCTOR-SMD	2703-002586	SA
L138	INDUCTOR-SMD	2703-001722	SA
L139	INDUCTOR-SMD	2703-001728	SA
L141	INDUCTOR-SMD	2703-001723	SA
L142	INDUCTOR-SMD	2703-002597	SA
L143	INDUCTOR-SMD	2703-002597	SA
L144	INDUCTOR-SMD	2703-001722	SA
L145	C-CER,CHIP	2203-002668	SA
L300	BEAD-SMD	3301-001534	SA
L401	BEAD-SMD	3301-001120	SA
L402	INDUCTOR-SMD	2703-002653	SA
L500	INDUCTOR-SMD	2703-001723	SA
L501	INDUCTOR-SMD	2703-001723	SA
L502	BEAD-SMD	3301-001756	SA
L503	BEAD-SMD	3301-001756	SA
L504	BEAD-SMD	3301-001729	SA
L601	BEAD-SMD	3301-001534	SA
L602	BEAD-SMD	3301-001729	SA
L603	BEAD-SMD	3301-001729	SA
L604	BEAD-SMD	3301-001729	SA
L700	BEAD-SMD	3301-001438	SA
L701	BEAD-SMD	3301-001438	SA
L710	INDUCTOR-SMD	2703-001723	SA
L711	INDUCTOR-SMD	2703-001723	SA
L712	INDUCTOR-SMD	2703-001938	SA
L713	INDUCTOR-SMD	2703-001938	SA
L714	INDUCTOR-SMD	2703-001938	SA
L715	INDUCTOR-SMD	2703-001938	SA
L802	BEAD-SMD	3301-001729	SA
L804	INDUCTOR-SMD	2703-001174	SA
L805	INDUCTOR-SMD	2703-001174	SA
LED801	LED	0601-002053	SA
LED805	LED	0601-002053	SA
LED807	LED	0601-002053	SA
LED810	LED	0601-002053	SA
OSC300	CRYSTAL-SMD	2801-004340	SA
OSC400	CRYSTAL-SMD	2801-004373	SA
PAM100	IC-POWER AMP	1201-002275	SA
R103	R-CHIP	2007-000148	SA
R105	R-CHIP	2007-000172	SA
R111	R-CHIP	2007-000171	SA
R112	R-CHIP	2007-000148	SA
R113	R-CHIP	2007-000162	SA
R114	R-CHIP	2007-000171	SA
R115	R-CHIP	2007-000171	SA

DESIGN LOC	DESCRIPTION	SEC CODE	STATUS
R116	R-CHIP	2007-000171	SA
R117	R-CHIP	2007-000171	SA
R127	R-CHIP	2007-000171	SA
R128	R-CHIP	2007-000171	SA
R129	R-CHIP	2007-007306	SA
R130	R-CHIP	2007-000171	SA
R135	INDUCTOR-SMD	2703-002198	SA
R136	INDUCTOR-SMD	2703-002198	SA
R137	R-CHIP	2007-000171	SA
R138	R-CHIP	2007-000171	SA
R201	R-CHIP	2007-008516	SA
R208	R-CHIP	2007-000162	SA
R215	R-CHIP	2007-008478	SA
R216	R-CHIP	2007-008478	SA
R219	R-CHIP	2007-008052	SA
R220	R-CHIP	2007-000148	SA
R221	R-CHIP	2007-000147	SA
R223	R-CHIP	2007-000162	SA
R224	R-CHIP	2007-000162	SA
R250	R-CHIP	2007-000147	SA
R280	R-CHIP	2007-000140	SA
R300	R-CHIP	2007-000162	SA
R301	R-CHIP	2007-008055	SA
R304	R-CHIP	2007-000148	SA
R305	R-CHIP	2007-000170	SA
R306	R-CHIP	2007-008590	SNA
R307	R-CHIP	2007-000157	SA
R308	R-CHIP	2007-007312	SA
R309	R-CHIP	2007-008516	SA
R320	R-CHIP	2007-000162	SA
R322	R-CHIP	2007-000140	SA
R323	R-CHIP	2007-000162	SA
R324	R-CHIP	2007-000159	SA
R325	R-CHIP	2007-000162	SA
R327	R-CHIP	2007-000166	SA
R328	R-CHIP	2007-008055	SA
R333	R-CHIP	2007-000162	SA
R335	R-CHIP	2007-009157	SA
R336	R-CHIP	2007-007142	SA
R337	R-CHIP	2007-000146	SA
R338	R-CHIP	2007-000171	SA
R340	R-CHIP	2007-008055	SA
R401	R-CHIP	2007-007100	SA
R404	R-CHIP	2007-000162	SA
R500	R-CHIP	2007-002796	SA
R501	R-CHIP	2007-000140	SA
R504	R-CHIP	2007-007573	SA
R505	R-CHIP	2007-000140	SA
R506	R-CHIP	2007-002796	SA
R507	R-CHIP	2007-002796	SA

## Electrical Parts List

DESIGN LOC	DESCRIPTION	SEC CODE	STATUS
R508	R-CHIP	2007-000162	SA
R509	R-CHIP	2007-009170	SA
R511	R-CHIP	2007-008419	SA
R512	R-CHIP	2007-008419	SA
R513	R-CHIP	2007-002796	SA
R520	R-CHIP	2007-007009	SA
R522	R-CHIP	2007-001306	SA
R530	R-CHIP	2007-001325	SA
R531	R-CHIP	2007-007137	SA
R532	R-CHIP	2007-001325	SA
R533	R-CHIP	2007-007137	SA
R535	R-CHIP	2007-000162	SA
R537	R-CHIP	2007-007142	SA
R538	R-CHIP	2007-007334	SA
R550	R-CHIP	2007-000162	SA
R551	R-CHIP	2007-007314	SA
R552	R-CHIP	2007-007314	SA
R558	R-CHIP	2007-007791	SA
R559	R-CHIP	2007-007791	SA
R561	R-CHIP	2007-000162	SA
R565	R-CHIP	2007-008531	SA
R567	R-CHIP	2007-008531	SA
R600	R-CHIP	2007-008516	SA
R601	R-CHIP	2007-007107	SA
R603	R-CHIP	2007-000162	SA
R604	R-CHIP	2007-008483	SA
R605	R-CHIP	2007-007573	SA
R606	R-CHIP	2007-000142	SA
R607	R-CHIP	2007-007318	SA
R608	R-CHIP	2007-007588	SA
R609	R-CHIP	2007-007334	SA
R612	R-CHIP	2007-000170	SA
R613	R-CHIP	2007-000170	SA
R617	R-CHIP	2007-000148	SA
R618	R-CHIP	2007-000162	SA
R620	R-CHIP	2007-007312	SA
R623	R-CHIP	2007-008055	SA
R801	R-CHIP	2007-003030	SA
R802	R-CHIP	2007-003030	SA
R806	R-CHIP	2007-003030	SA
R807	R-CHIP	2007-003030	SA
R814	R-CHIP	2007-000162	SA
R830	R-CHIP	2007-000141	SA
R831	R-CHIP	2007-000141	SA
R835	R-CHIP	2007-000151	SA
R836	R-CHIP	2007-000151	SA
RFS100	CONNECTOR-COAXIAL	3705-001358	SA
SIM400	CONNECTOR-CARD EDGE	3709-001365	SA
SLC700	CONNECTOR-FPC/FFC/PIC	3708-002170	SA
SLC811	CONNECTOR-FPC/FFC/PIC	3708-002170	SA



DESIGN LOC	DESCRIPTION	SEC CODE	STATUS
TA100	C-TA,CHIP	2404-001422	SA
TA410	C-TA,CHIP	2404-001381	SA
TA428	C-TA,CHIP	2404-001375	SA
TA500	C-TA,CHIP	2404-001422	SA
TA502	C-TA,CHIP	2404-001281	SA
TA534	C-TA,CHIP	2404-001225	SA
TA557	C-TA,CHIP	2404-001381	SA
TA560	C-TA,CHIP	2404-001402	SA
TA561	C-TA,CHIP	2404-001402	SA
TA562	C-TA,CHIP	2404-001281	SA
TA603	C-TA,CHIP	2404-001268	SA
TA831	C-TA,CHIP	2404-001339	SA
TCX100	OSCILLATOR-VCTCXO	2809-001294	SA
TR200	FET-SILICON	0505-001518	SA
TR201	FET-SILICON	0505-001518	SA
TR210	TR-DIGITAL	0504-001060	SA
TR312	TR-DIGITAL	0504-001151	SA
U100	IC-RF/VI/AUDIO S/W	1001-001347	SA
U102	IC-TRANSCEIVER	1205-002817	SA
U104	IC-ANALOG SWITCH	1001-001350	SA
U105	IC-ANALOG SWITCH	1001-001350	SA
U201	IC-ANALOG SWITCH	1001-001231	SA
U304	IC-POSI.FIXED REG.	1203-003754	SA
U305	IC-CMOS LOGIC	0801-002237	SA
U310	IC-POSI.FIXED REG.	1203-003829	SA
U311	IC-CMOS LOGIC	0801-002237	SA
U314	IC-POSI.FIXED REG.	1203-003767	SA
U315	IC-CODEC	1205-002834	SA
U316	IC-POSI.FIXED REG.	1203-003432	SA
U400	IC-POWER SUPERVISOR	1203-003882	SA
U401	IC-DC/DC CONVERTER	1203-003545	SA
U402	IC-POSI.FIXED REG.	1203-003754	SA
U503	IC-VIDEO AMP	1201-002147	SA
U504	IC-AUDIO AMP	1201-002241	SA
U510	IC-ANALOG SWITCH	1001-001231	SA
U511	IC-ANALOG SWITCH	1001-001231	SA
U512	IC-ANALOG SWITCH	1001-001231	SA
U514	IC-ANALOG MULTIPLEX	1001-001351	SA
U515	IC-ANALOG MULTIPLEX	1001-001349	SA
U517	IC-ANALOG SWITCH	1001-001231	SA
U518	IC-ANALOG SWITCH	1001-001231	SA
U600	IC-HALL EFFECT S/W	1009-001020	SA
U601	FILTER-EMI SMD	2901-001316	SA
U602	IC-POSI.FIXED REG.	1203-003754	SA
U603	IC-CODEC	1205-002681	SA
U605	IC-BATTERY	1203-003823	SA
U715	IC-POSI.FIXED REG.	1203-003754	SA
U716	IC-POSI.FIXED REG.	1203-003754	SA
U720	VARISTOR	1405-001161	SA
U721	VARISTOR	1405-001161	SA

## Electrical Parts List

DESIGN LOC	DESCRIPTION	SEC CODE	STATUS
U820	IC-SWITCH REG.	1203-003309	SA
U823	IC-POSI.FIXED REG.	1203-003754	SA
UCP200	IC-COMM. CONTROLLER	1205-002757	SA
UME307	IC-MCP	1108-000030	SA
VR100	VARISTOR	1405-001082	SA
VR101	VARISTOR	1405-001082	SA
VR102	VARISTOR	1405-001082	SA
VR300	DIODE-TVS	0406-001150	SA
VR301	VARISTOR	1405-001082	SA
VR302	DIODE-TVS	0406-001150	SA
VR303	VARISTOR	1405-001082	SA
VR304	VARISTOR	1405-001082	SA
VR305	VARISTOR	1405-001082	SA
VR400	VARISTOR	1405-001082	SA
VR500	VARISTOR	1405-001082	SA
VR501	VARISTOR	1405-001082	SA
VR600	THERMISTOR-NTC	1404-001221	SA
VR810	VARISTOR	1405-001082	SA
VR811	DIODE-TVS	0406-001201	SA
VR812	VARISTOR	1405-001082	SA
VR813	VARISTOR	1405-001082	SA
ZD600	DIODE-ZENER	0403-001411	SA
ZD605	DIODE-ZENER	0403-001427	SA

## 5. Block Diagrams

### 5-1. RF Solution Block Diagram

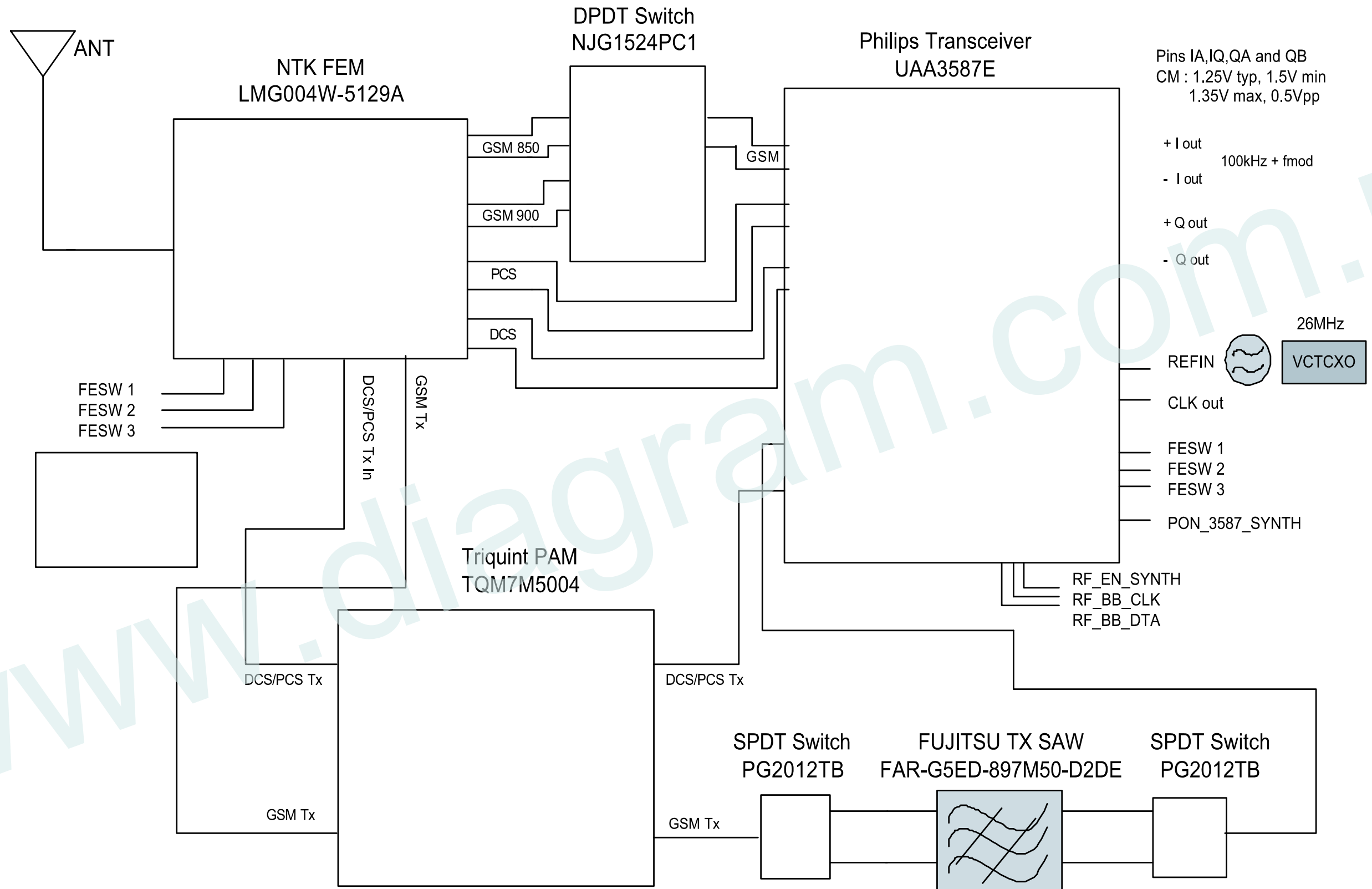

5-2. Base Band Solution Block Diagram

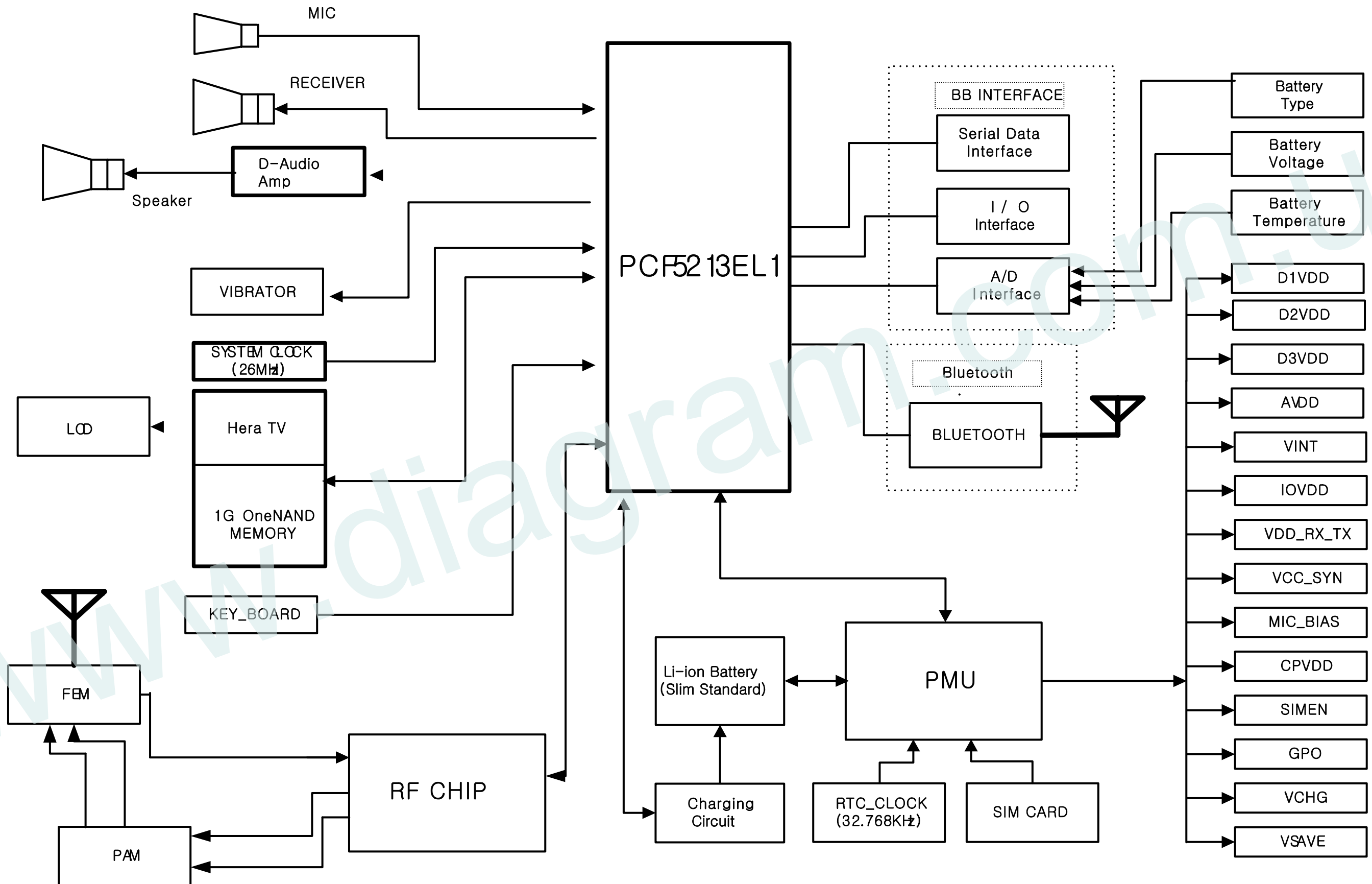

## 6. PCB Diagrams

### 6-1. Main PCB Top Diagram

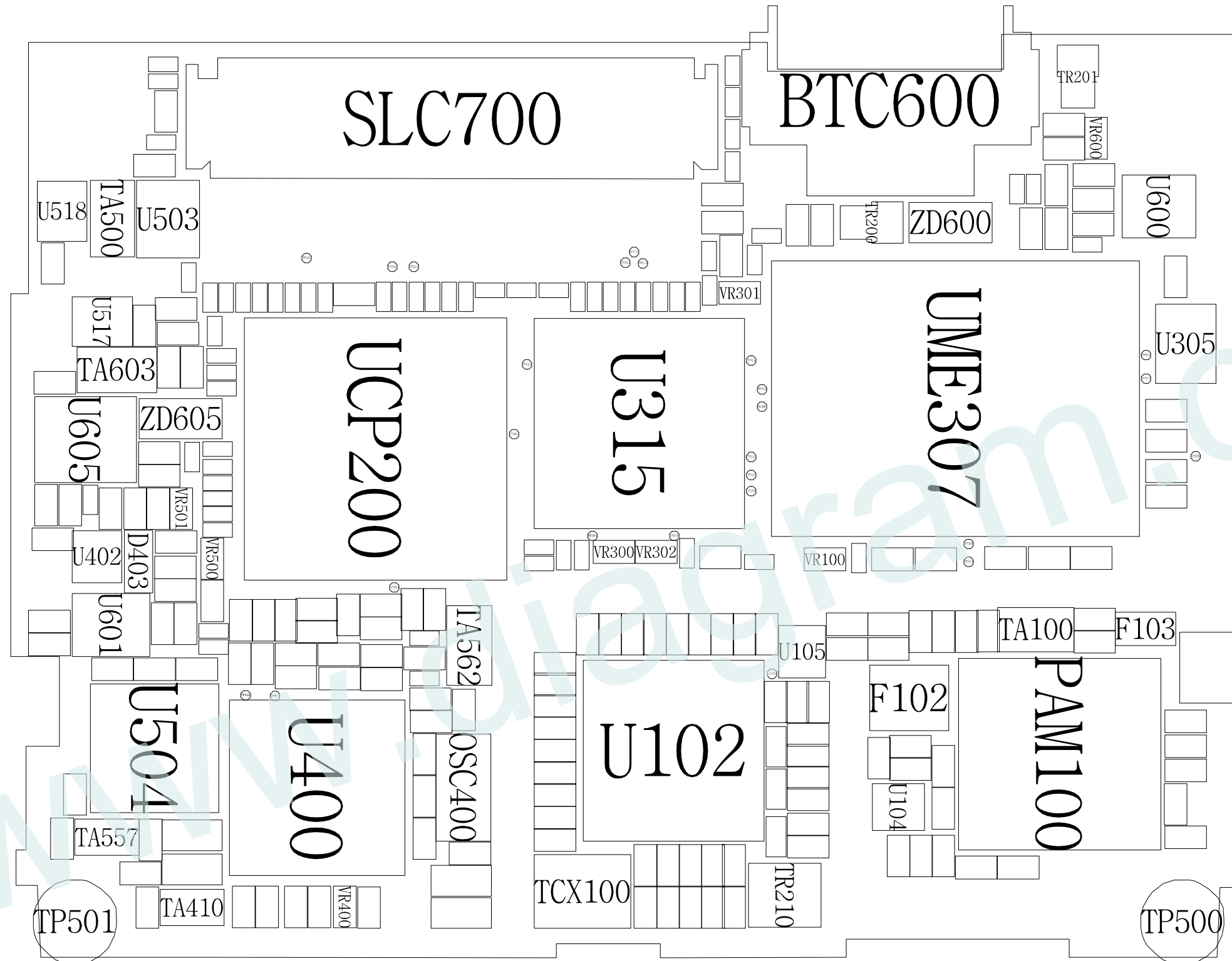

CN202

6-2. Main PCB Bottom Diagram

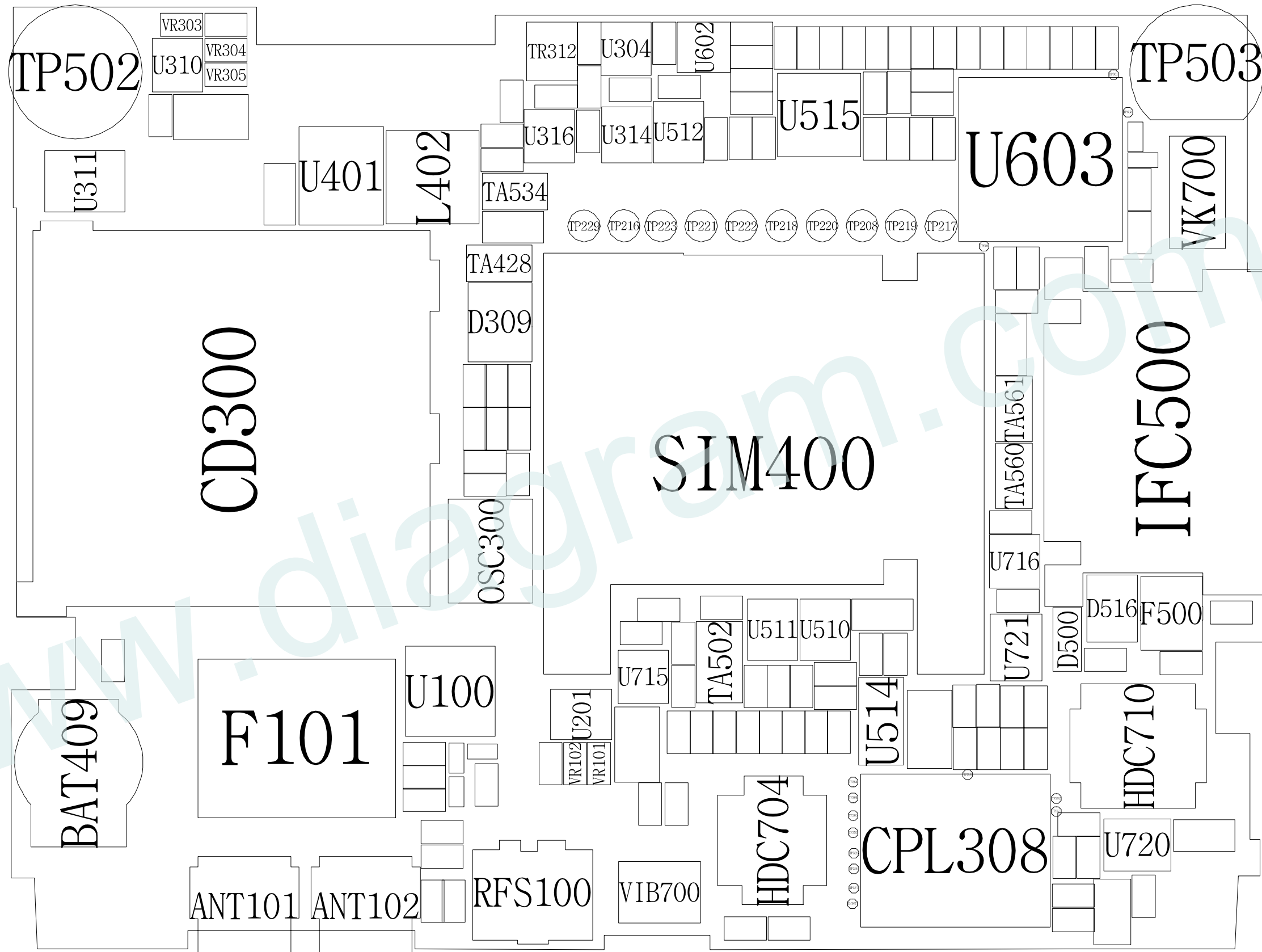

6-3. Sub PCB Top Diagram

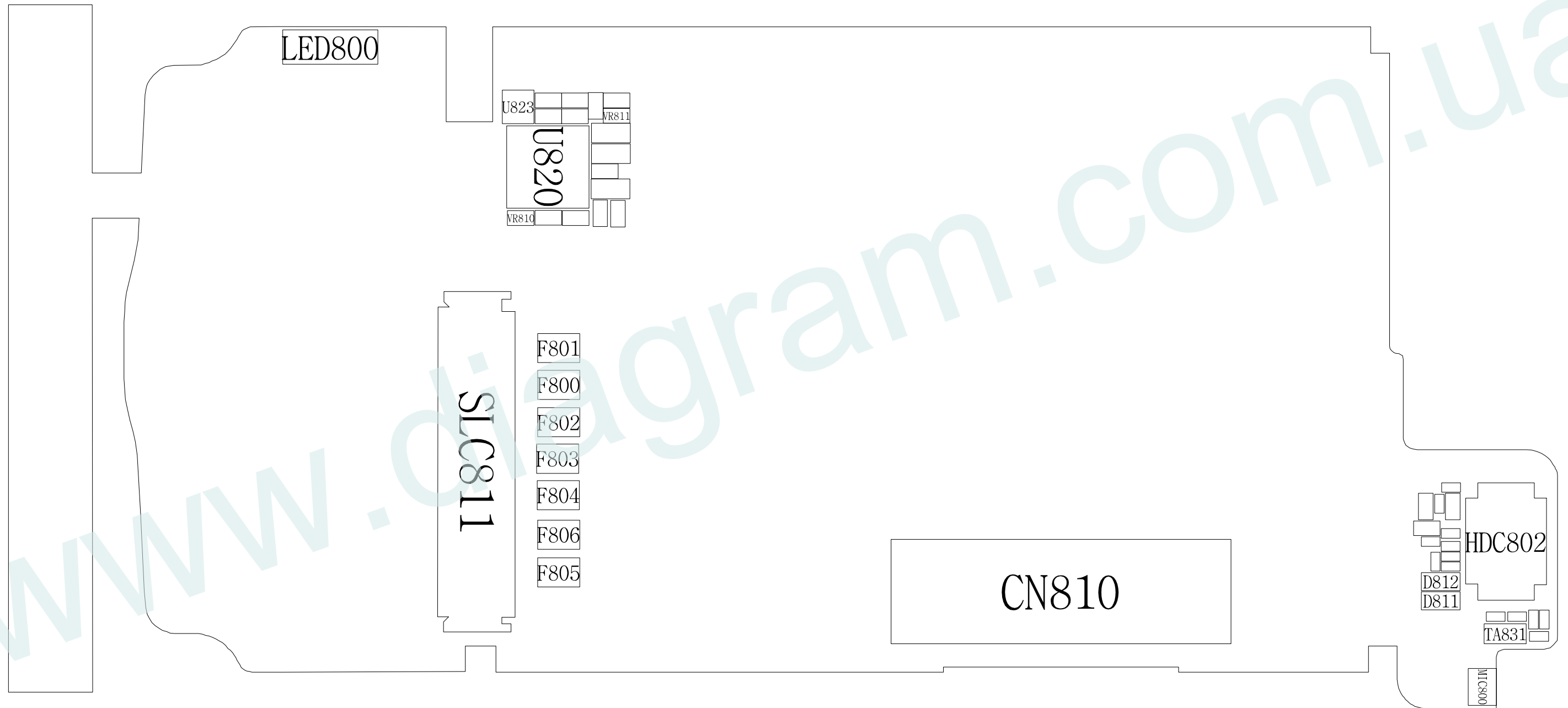

6-4. Sub PCB Bottom Diagram

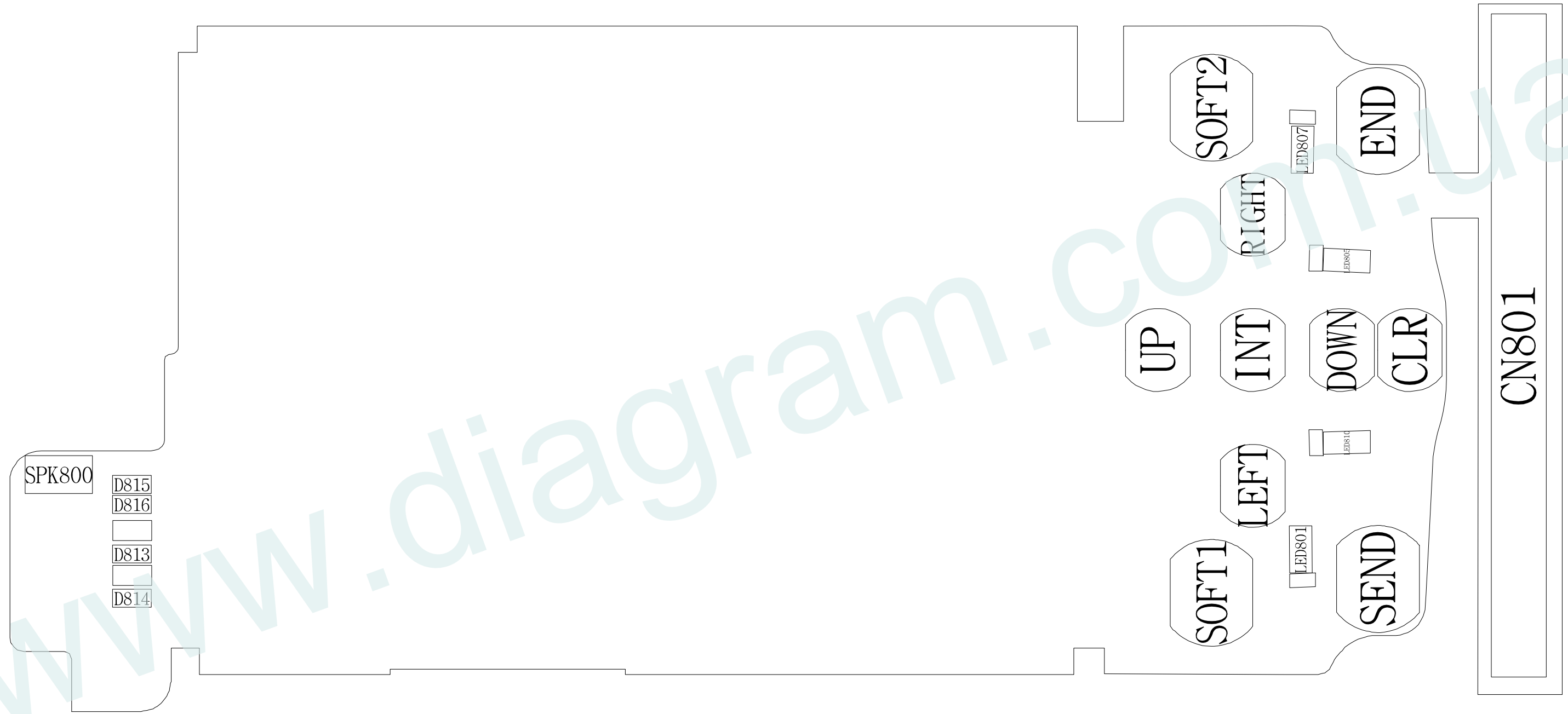



# 7. Flow Chart of Troubleshooting

## 7-1. Power On

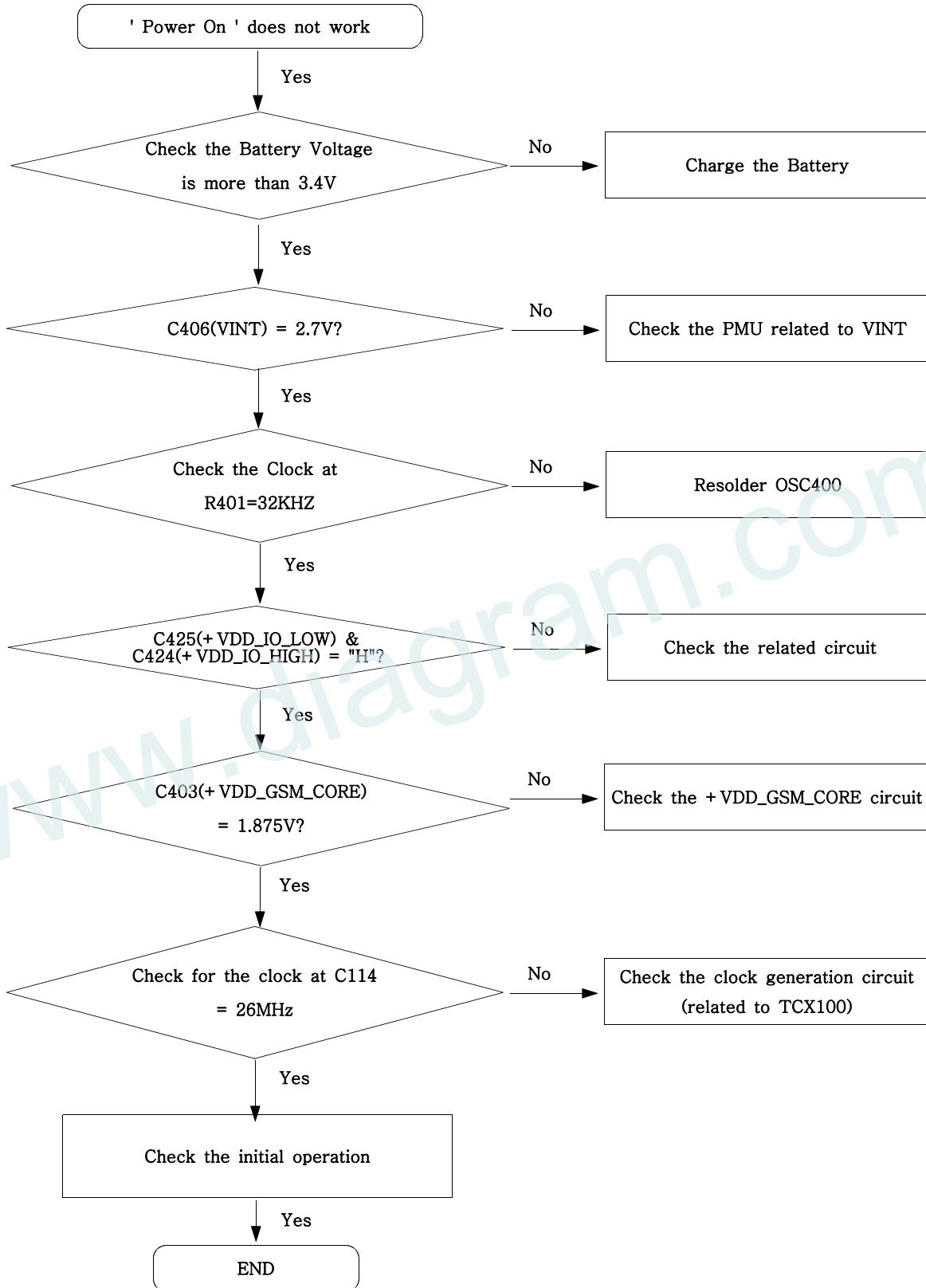

# Flow Chart of Troubleshooting

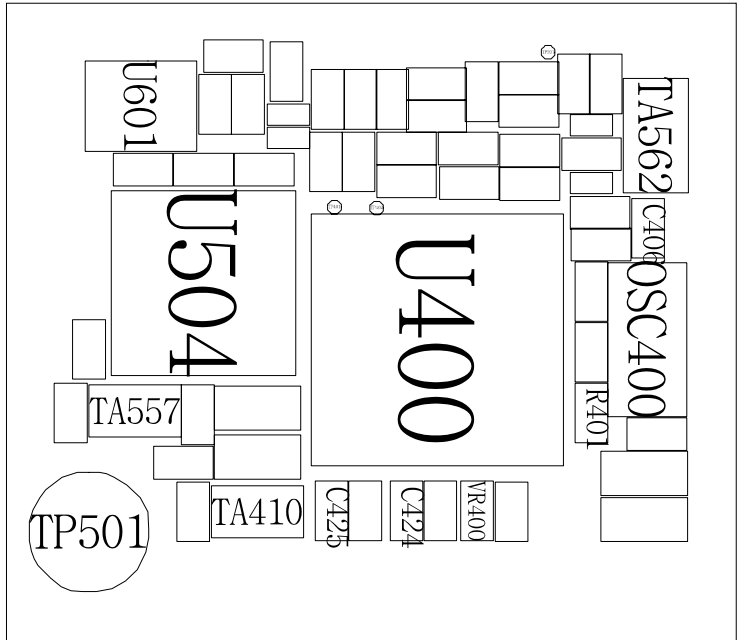
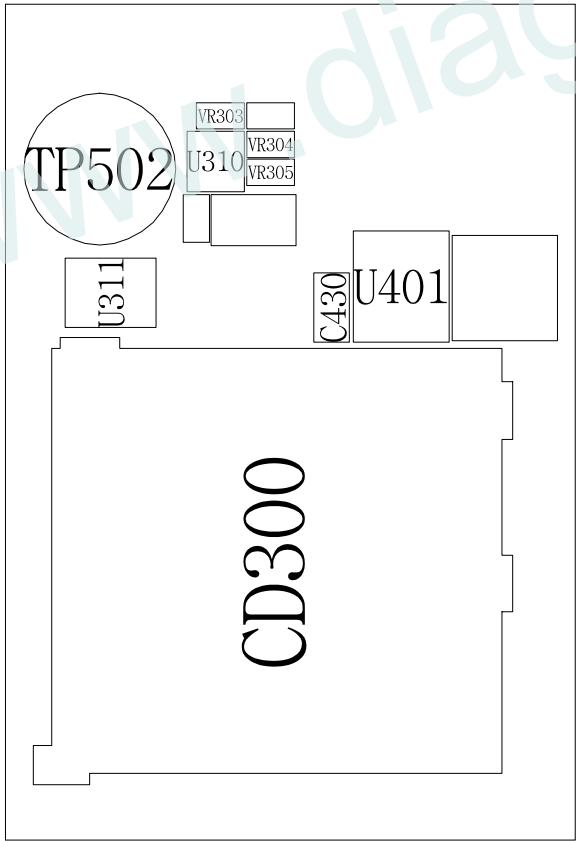
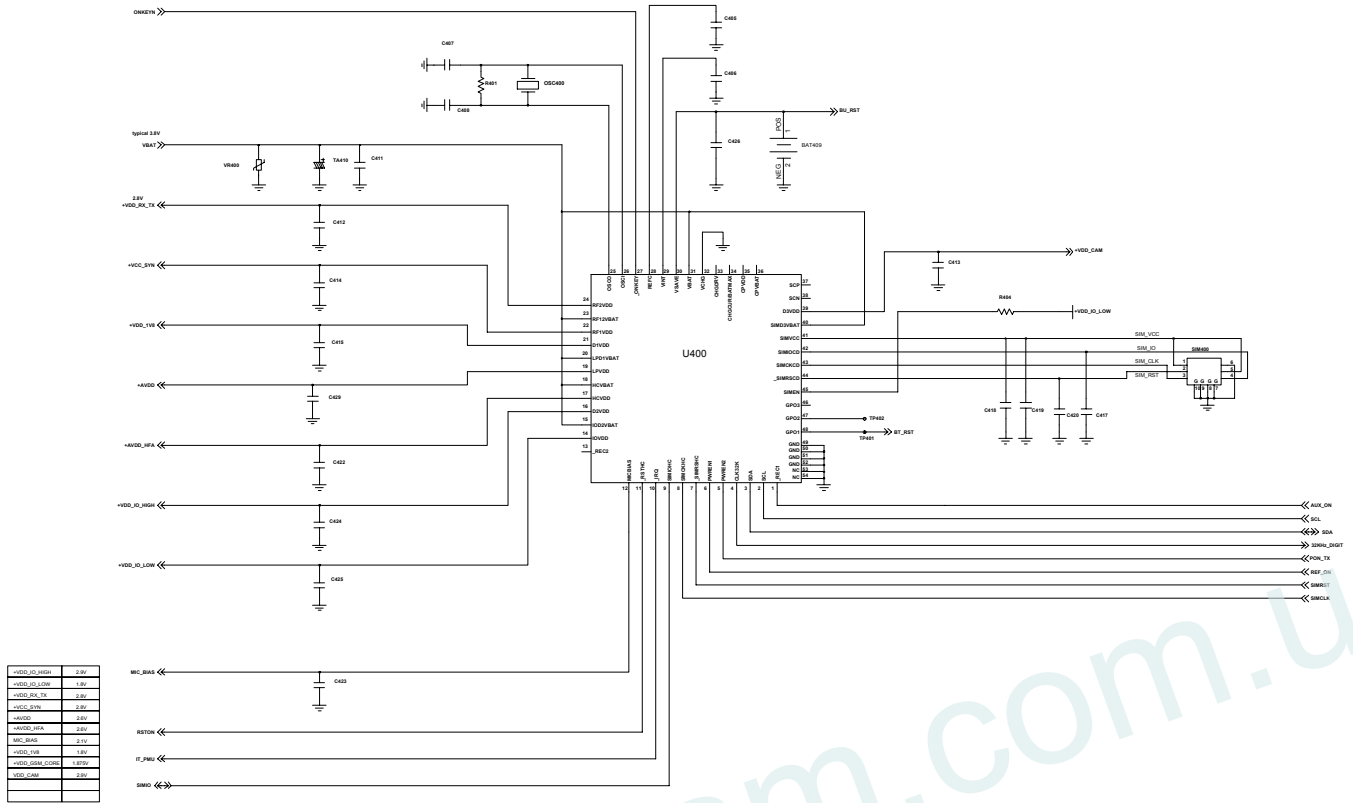

7-2. Initial

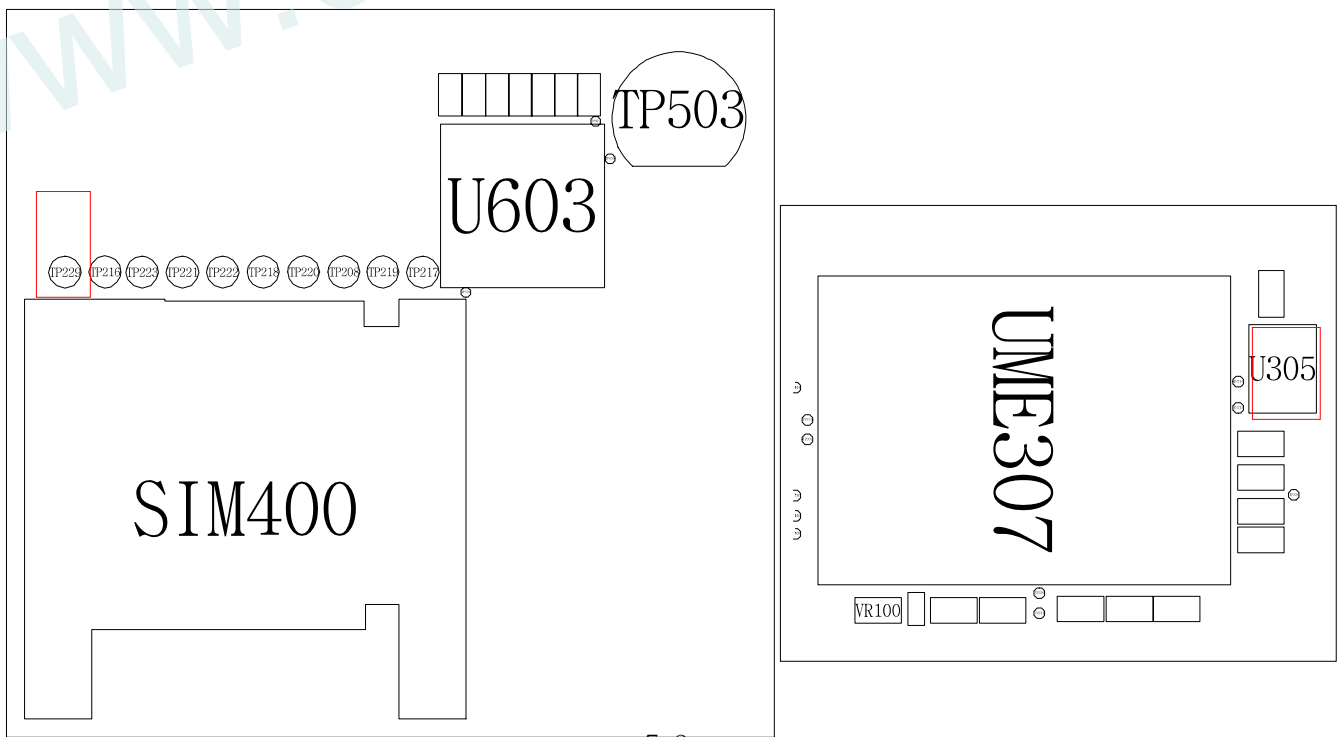
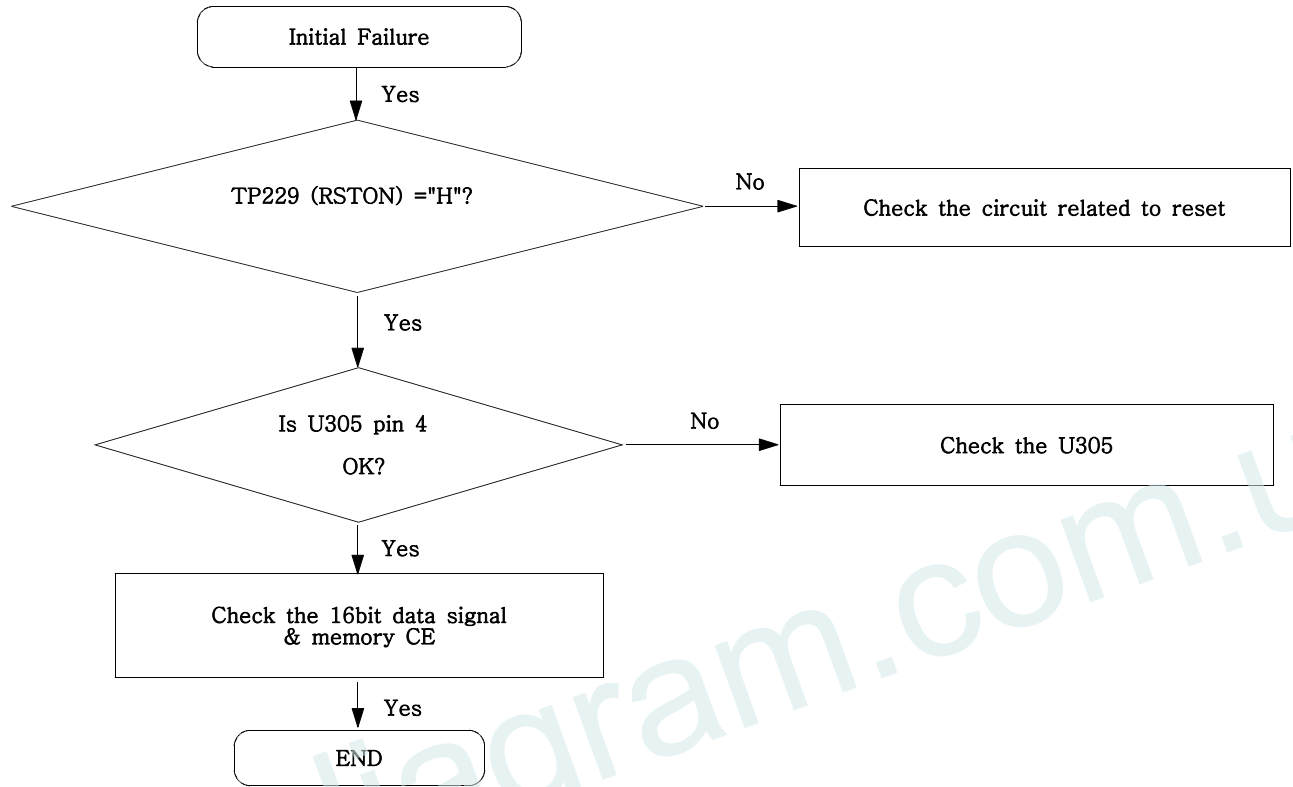

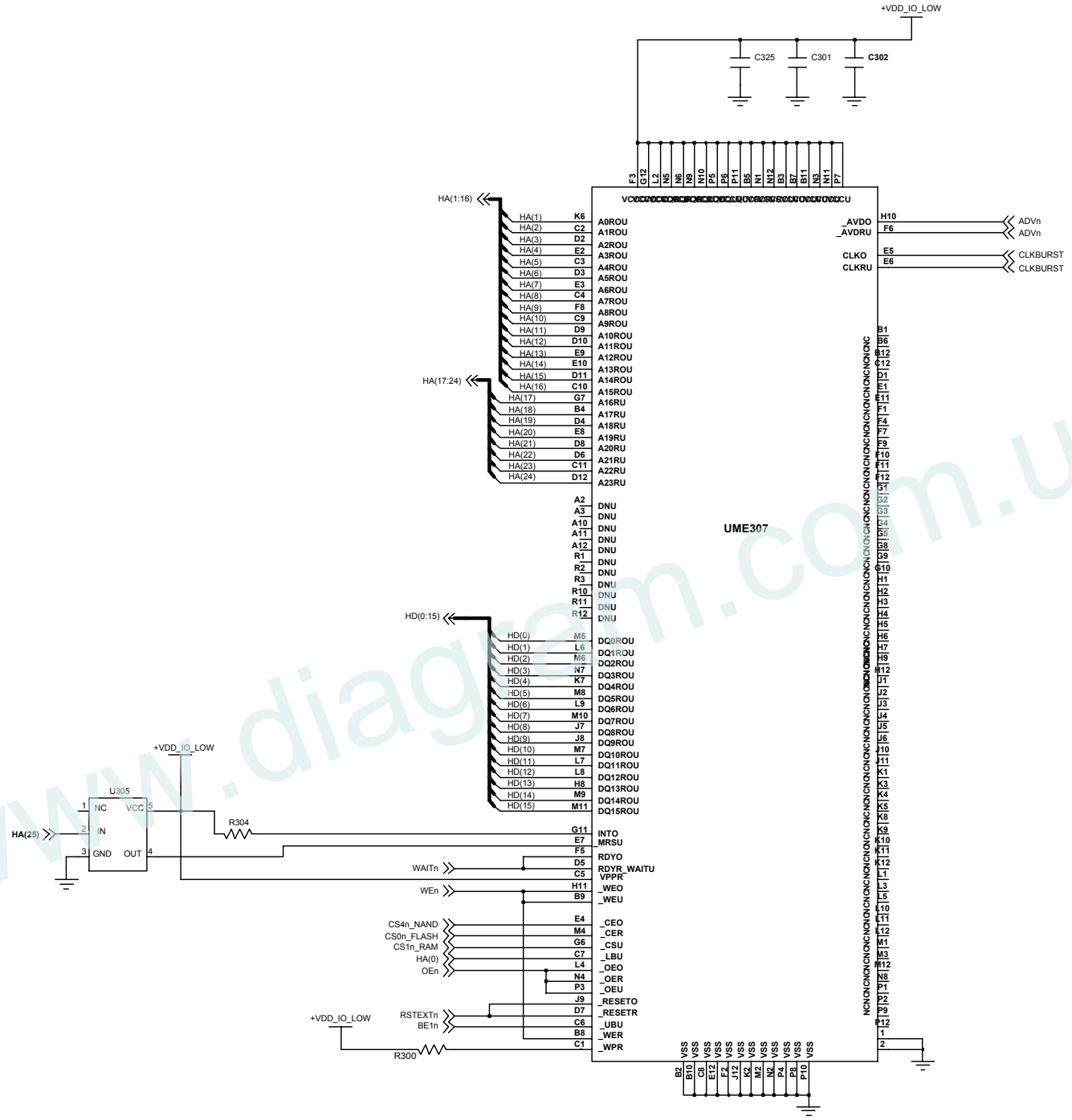

**MEMORY**

7-3. Charging Part

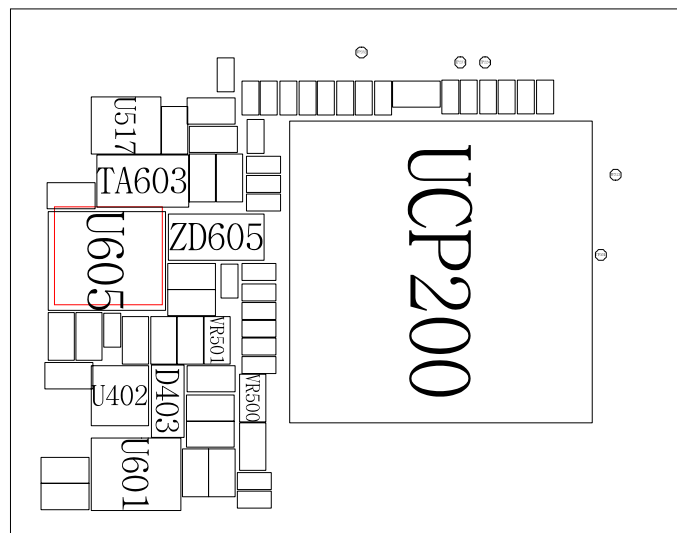
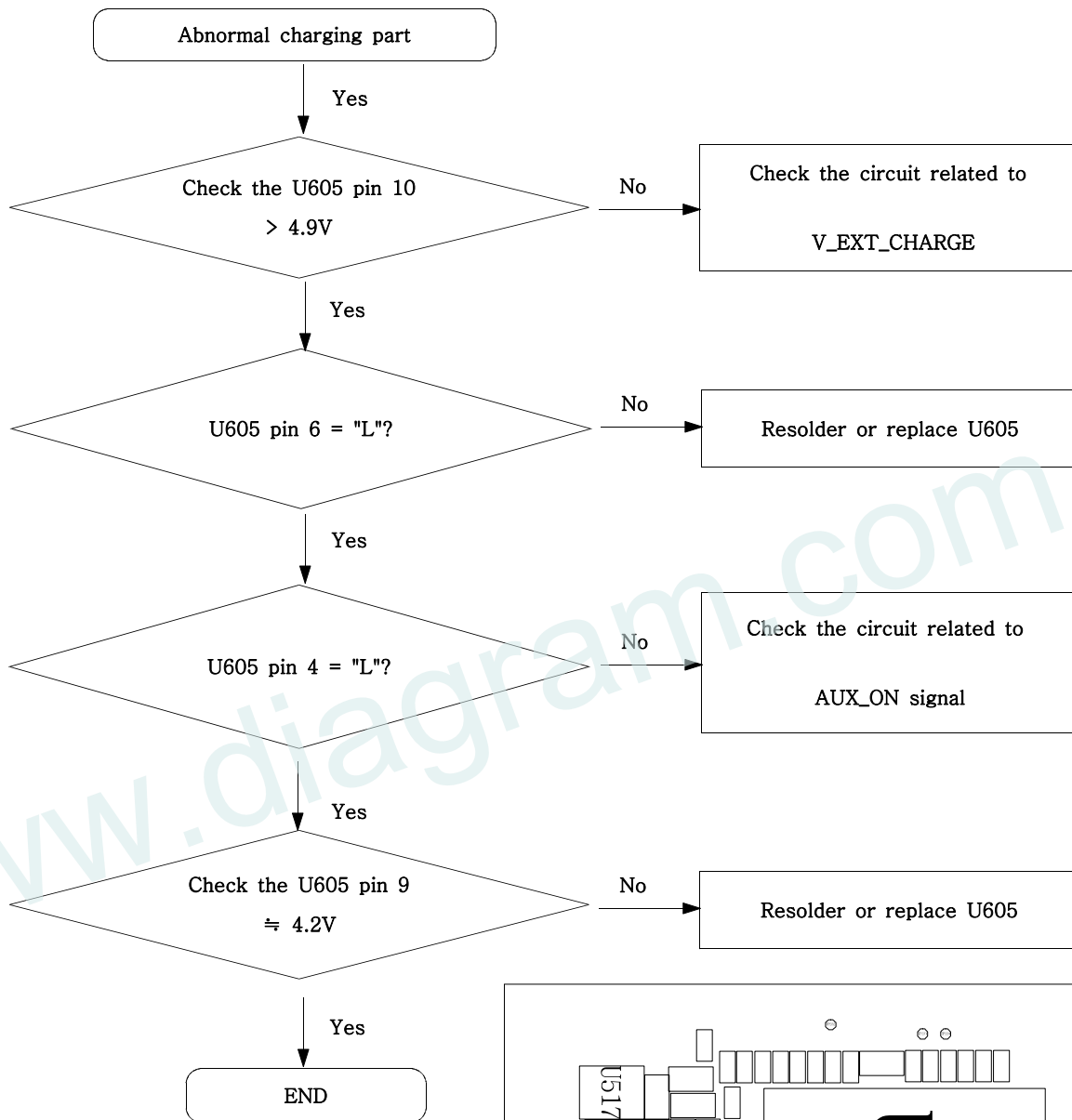

### 7-4. Sim Part

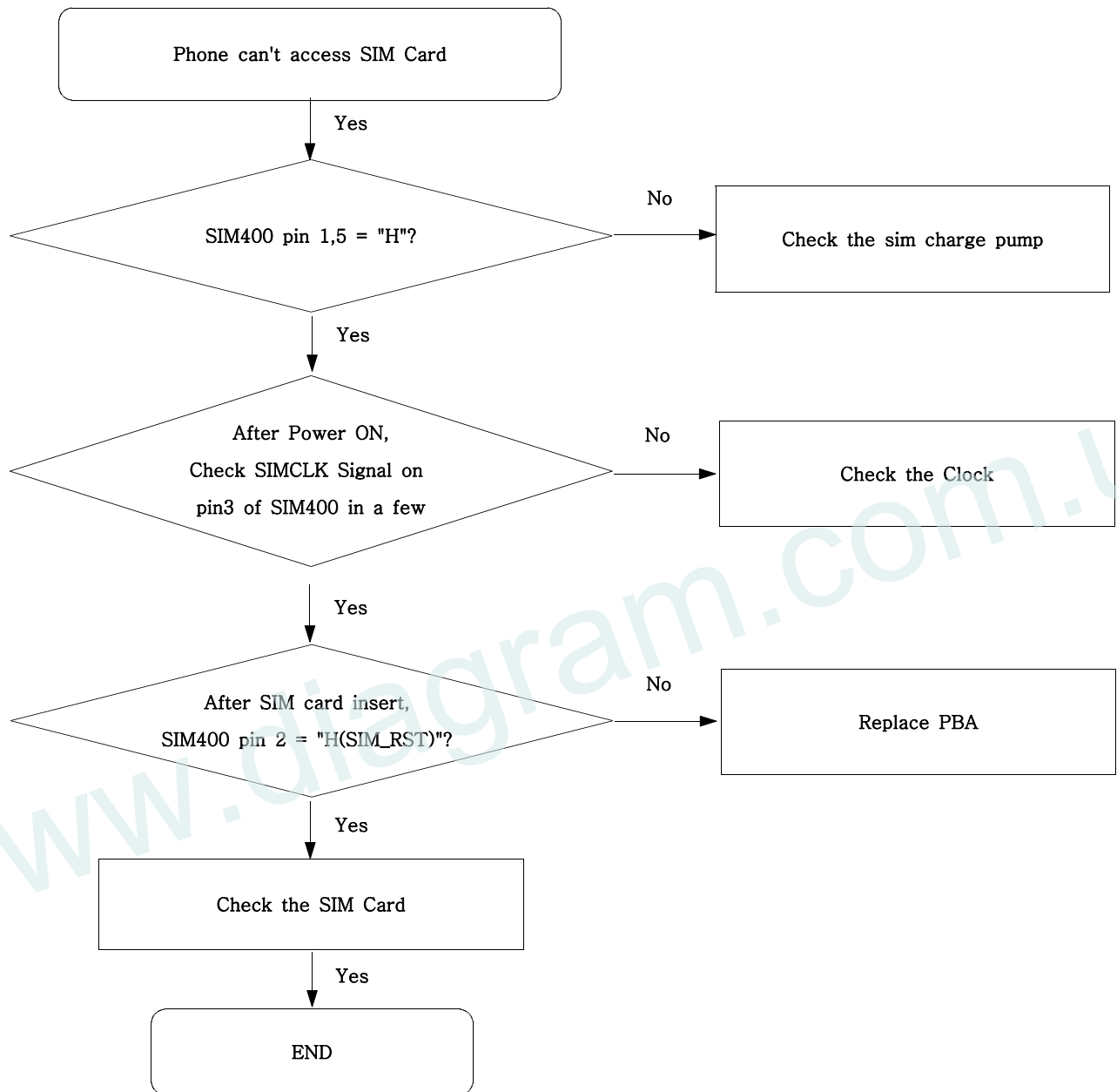

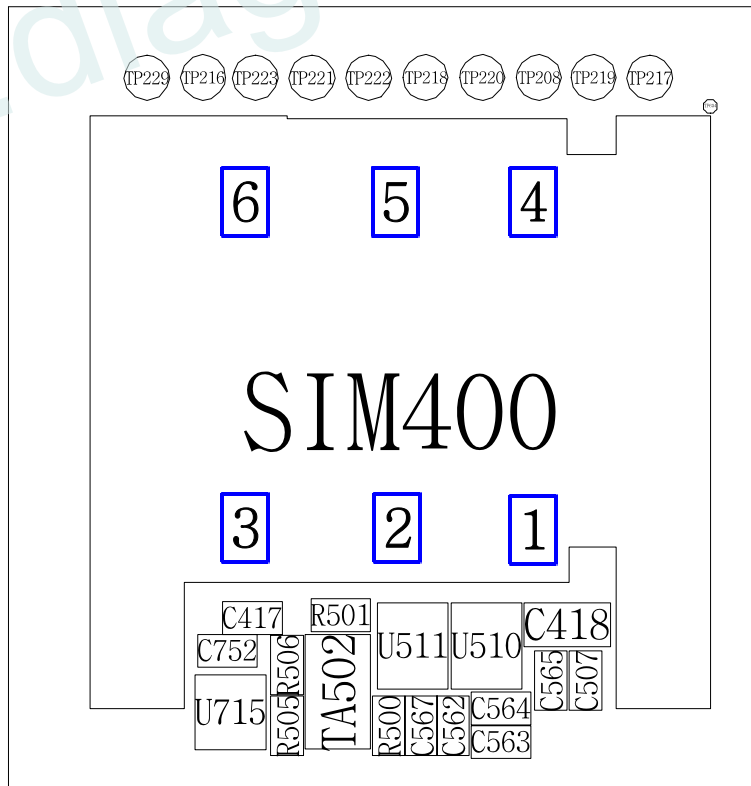
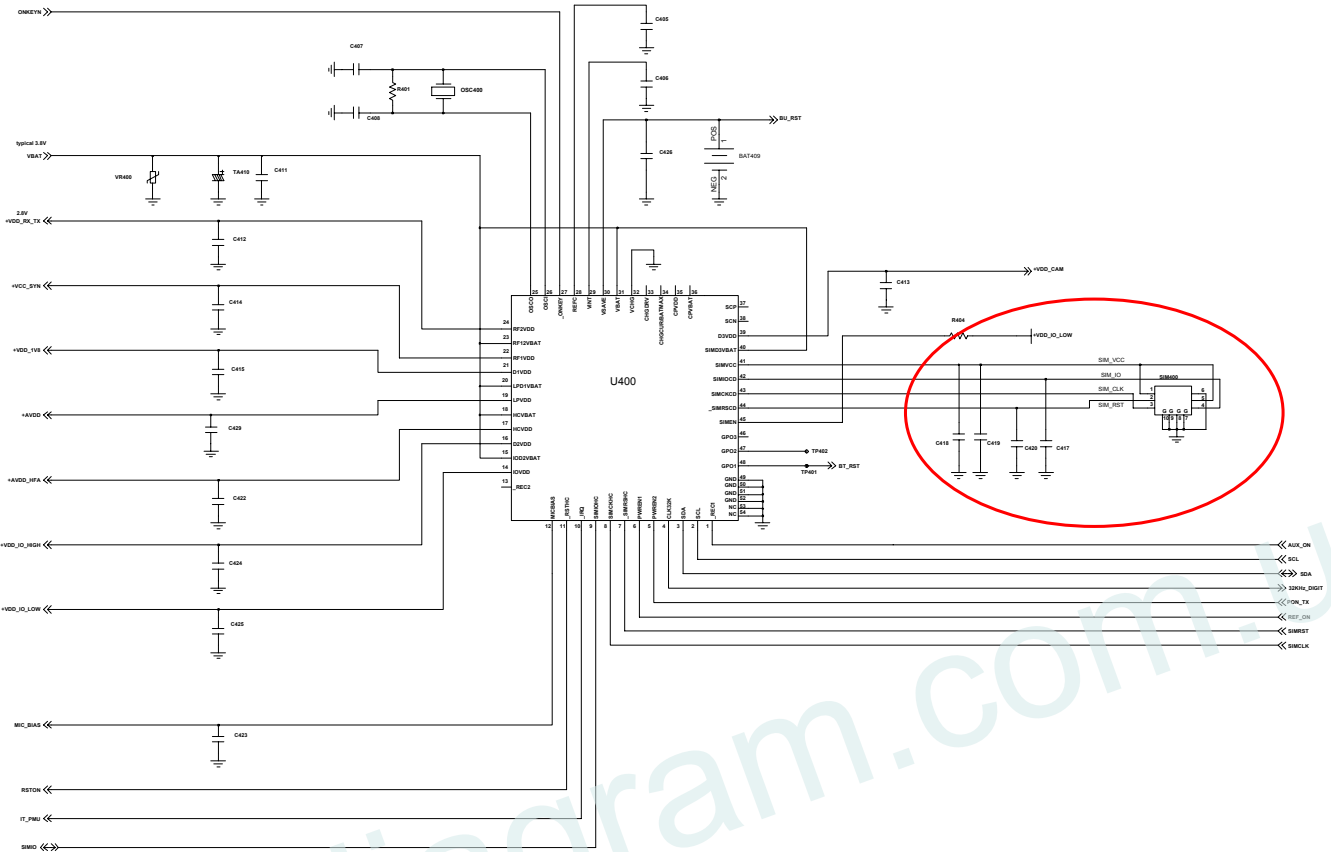

### 7-5. Microphone Part (Main)

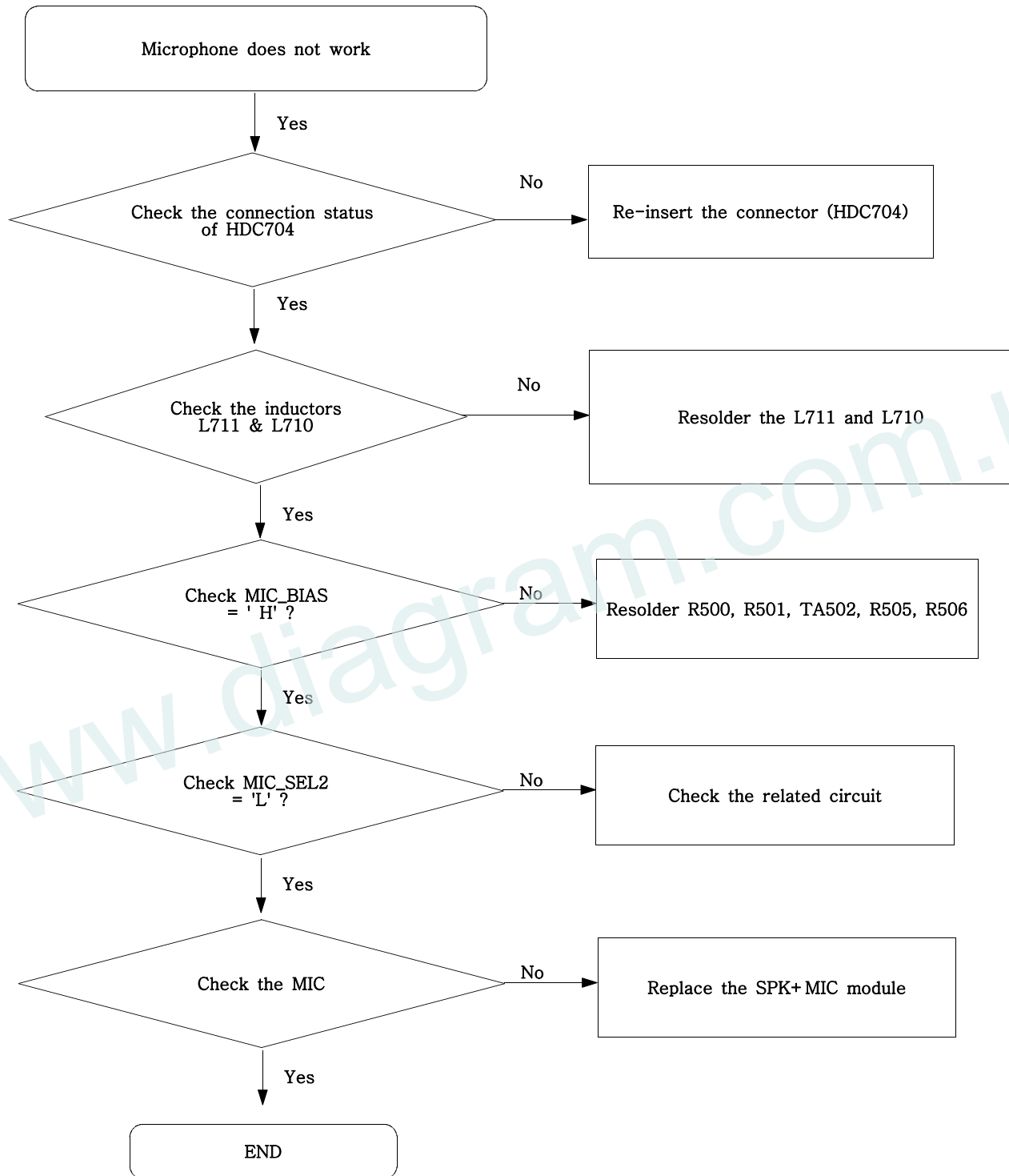



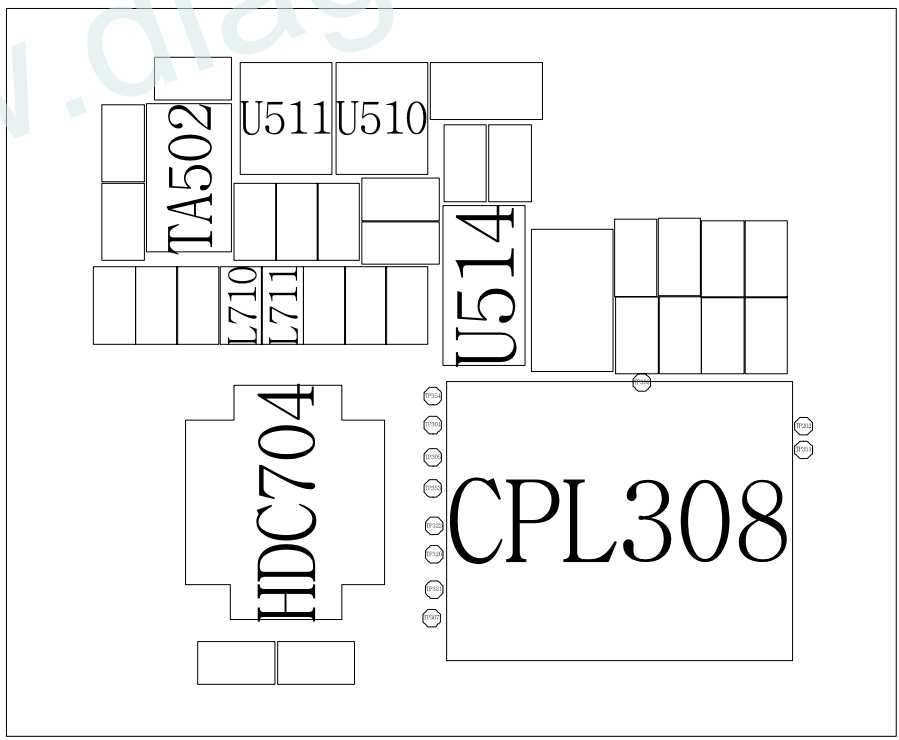
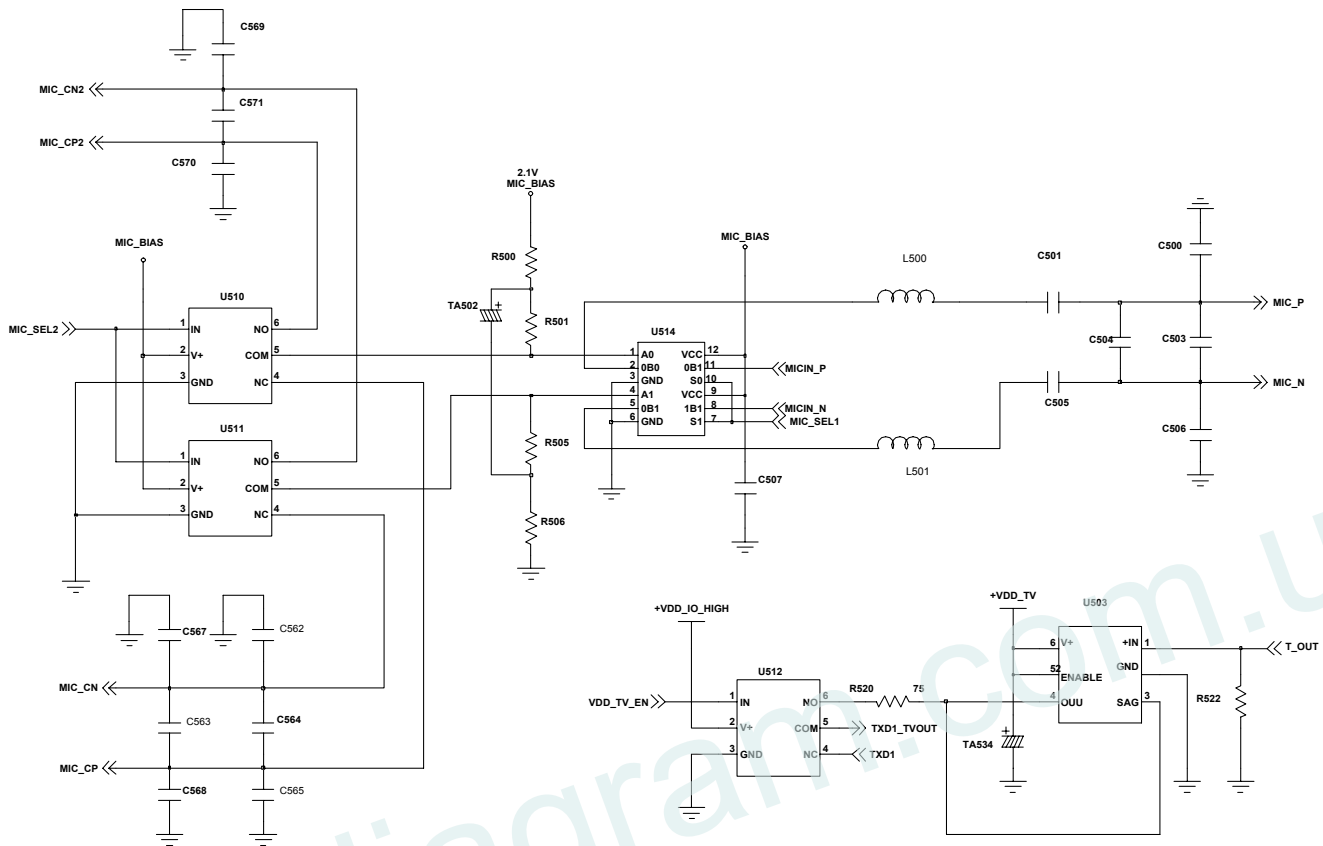

### 7-6. Microphone Part (Sub)

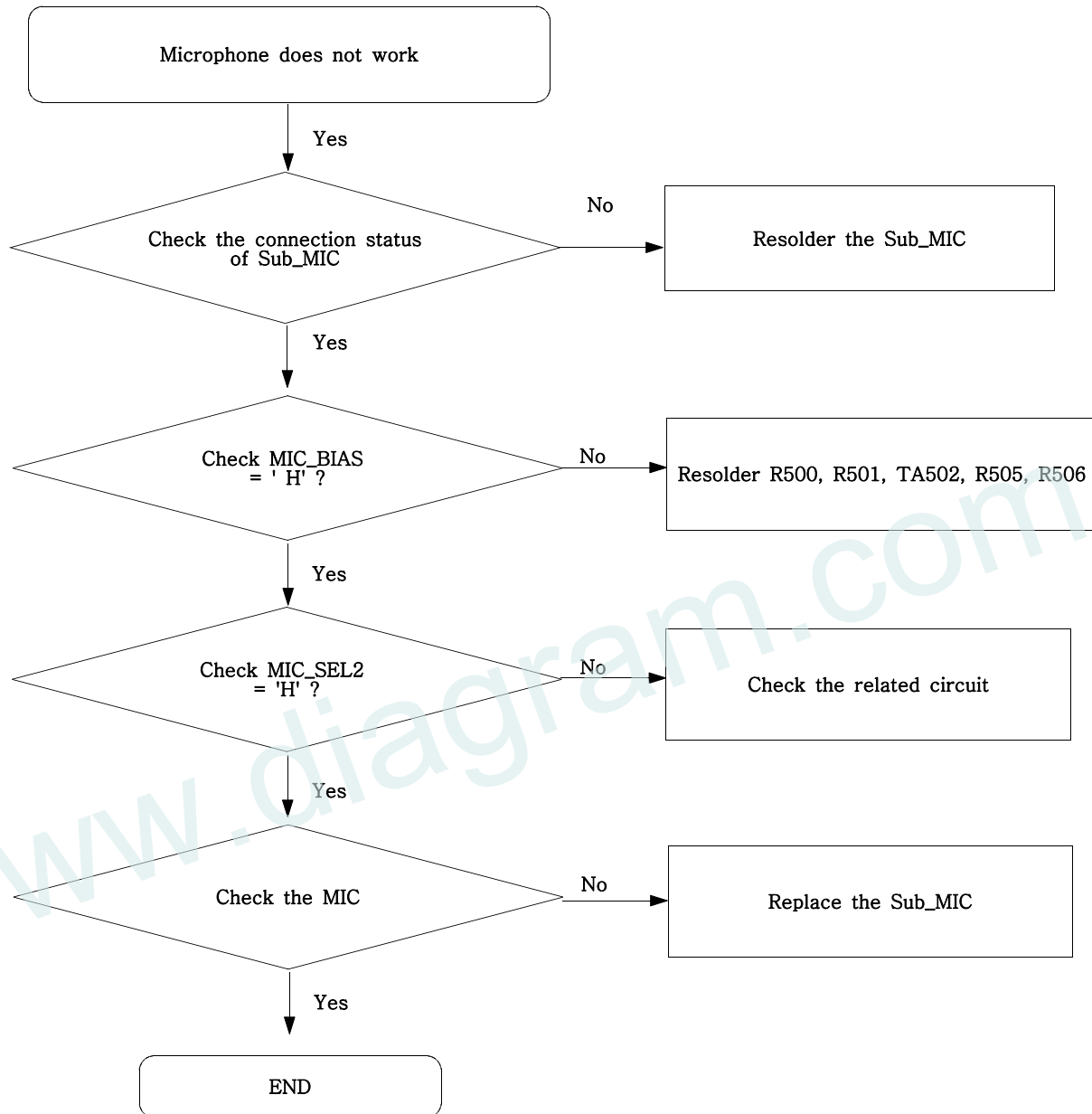

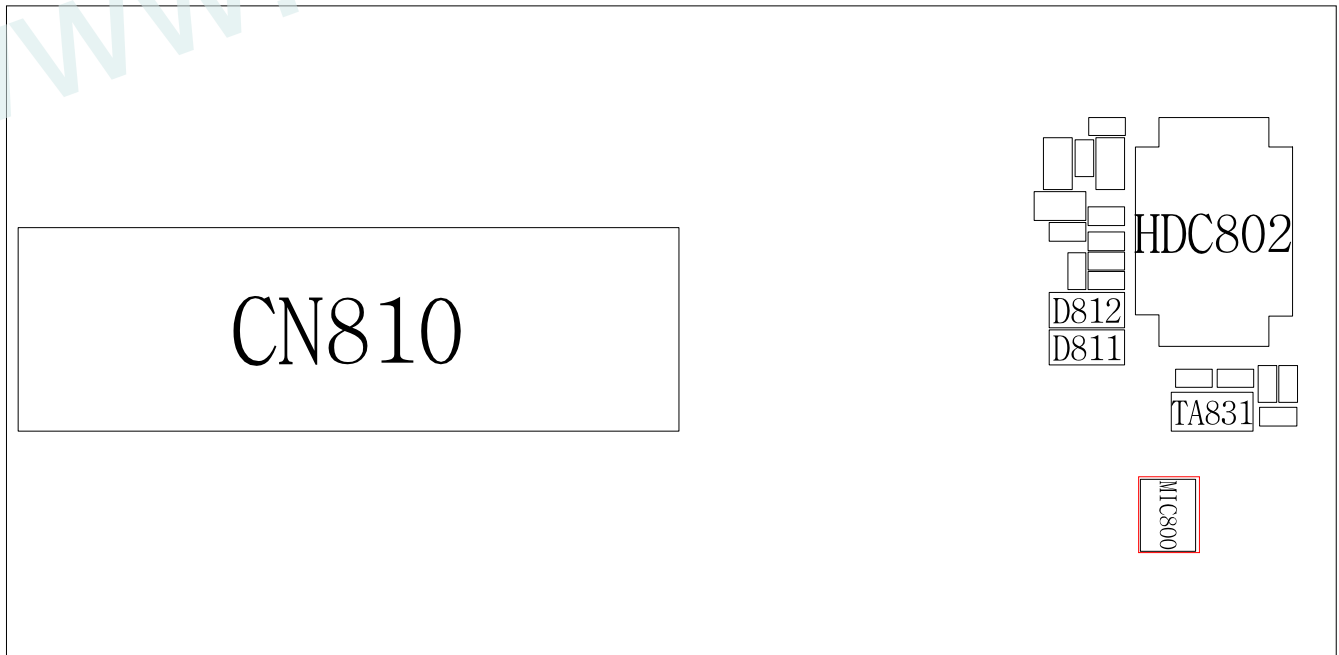
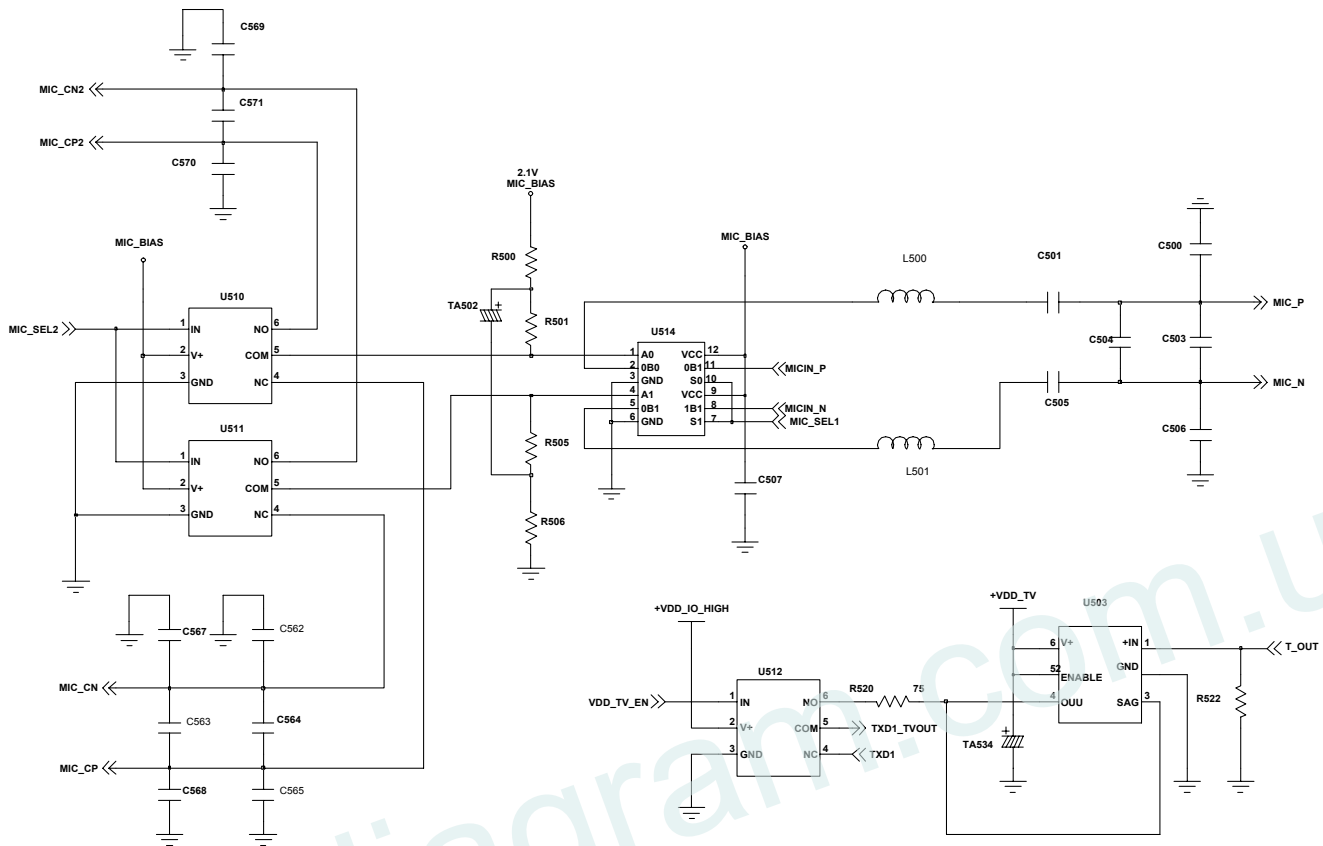

### 7-7. Speaker Part

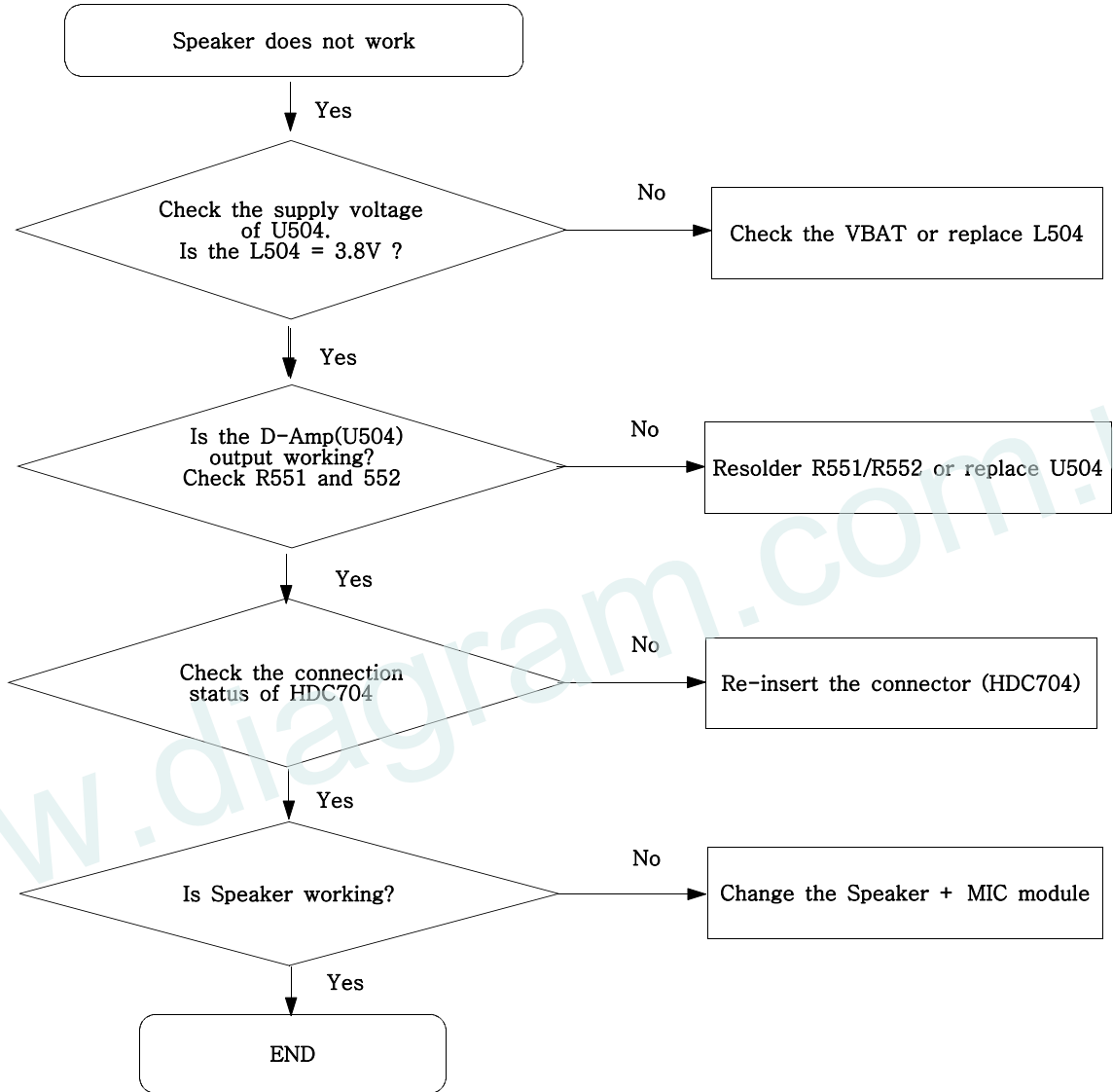

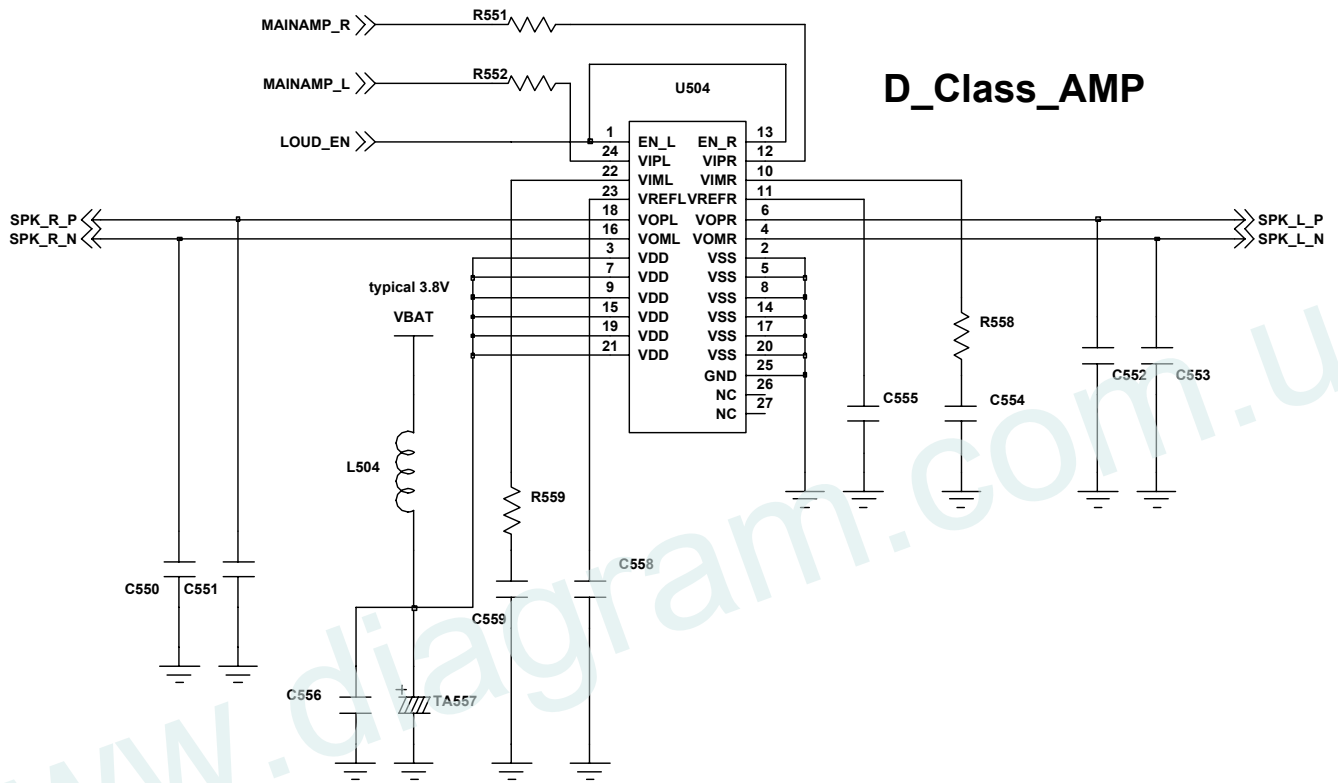

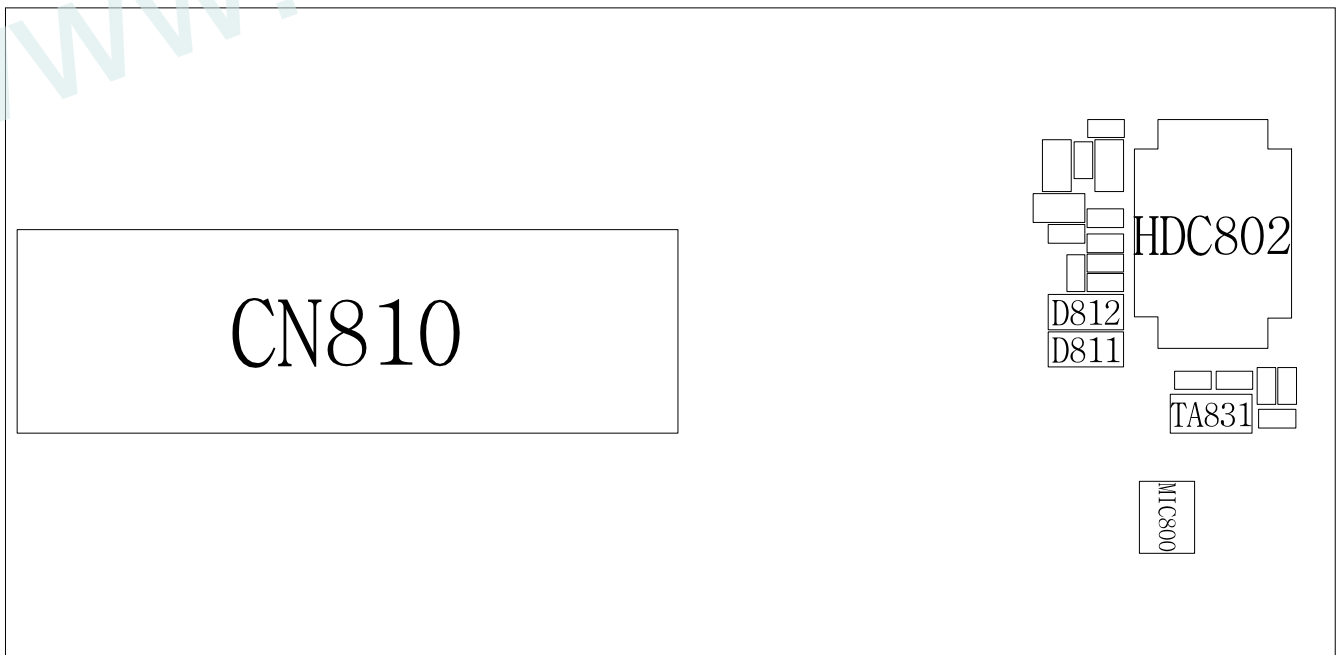
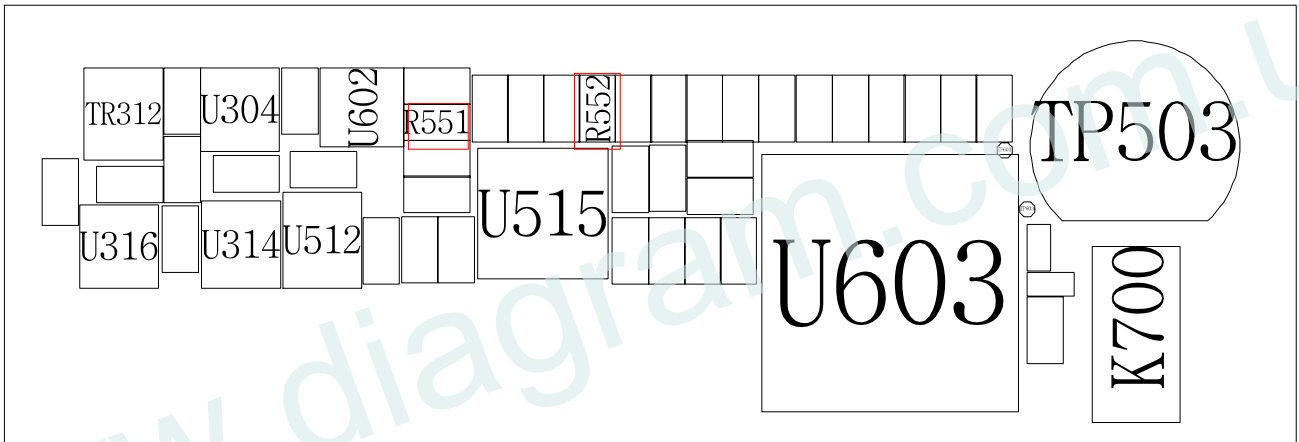
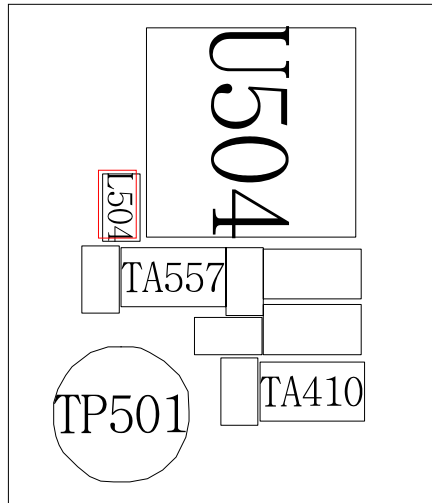

## 7-8. Key Data Input

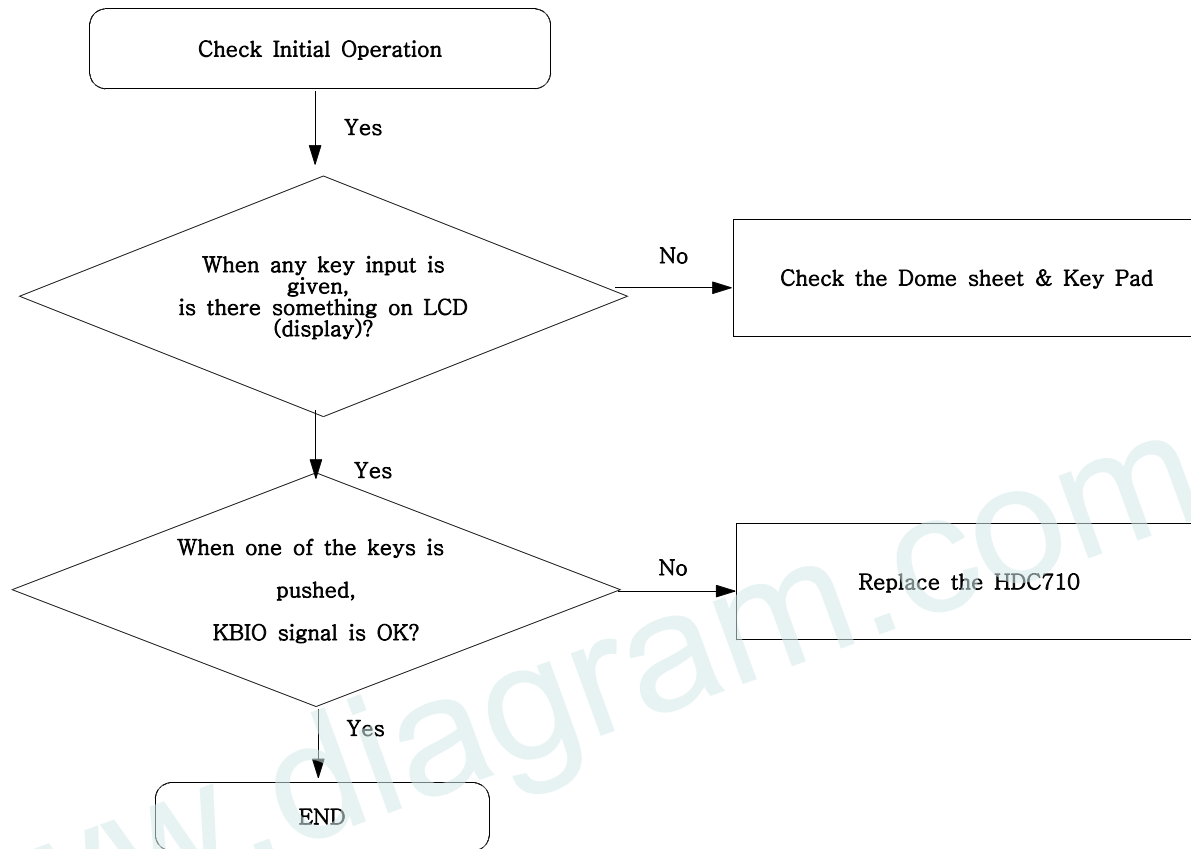

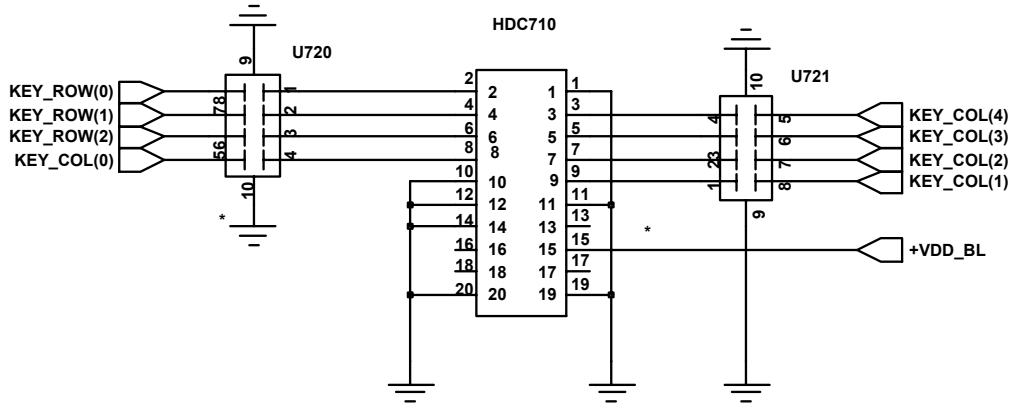

# KEY\_CONNECTOR

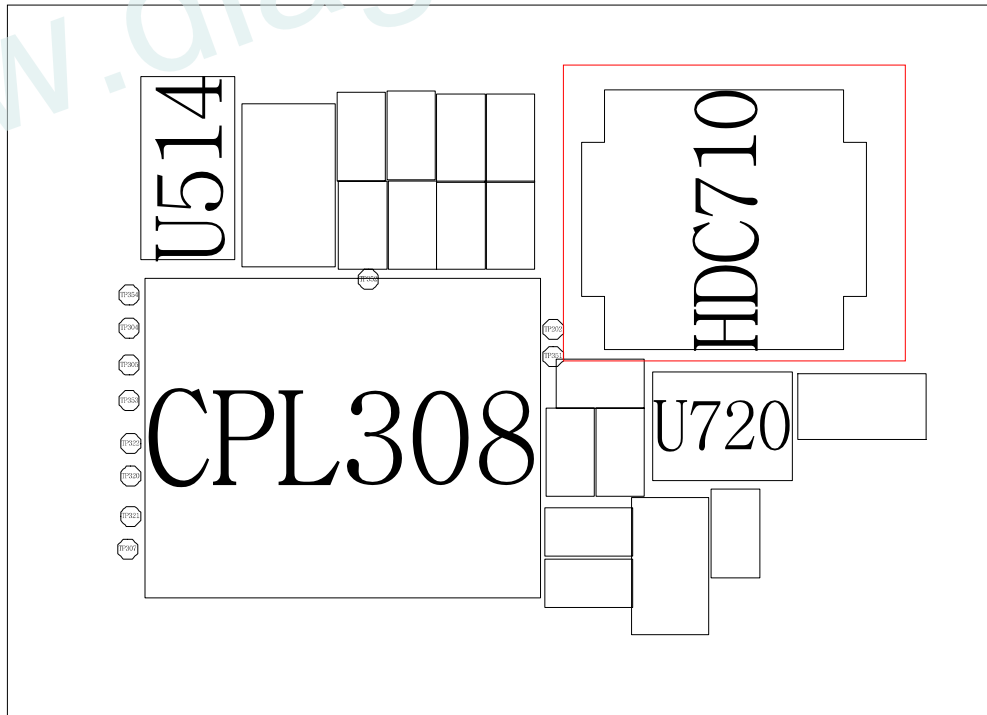



7-9. Receiver Part

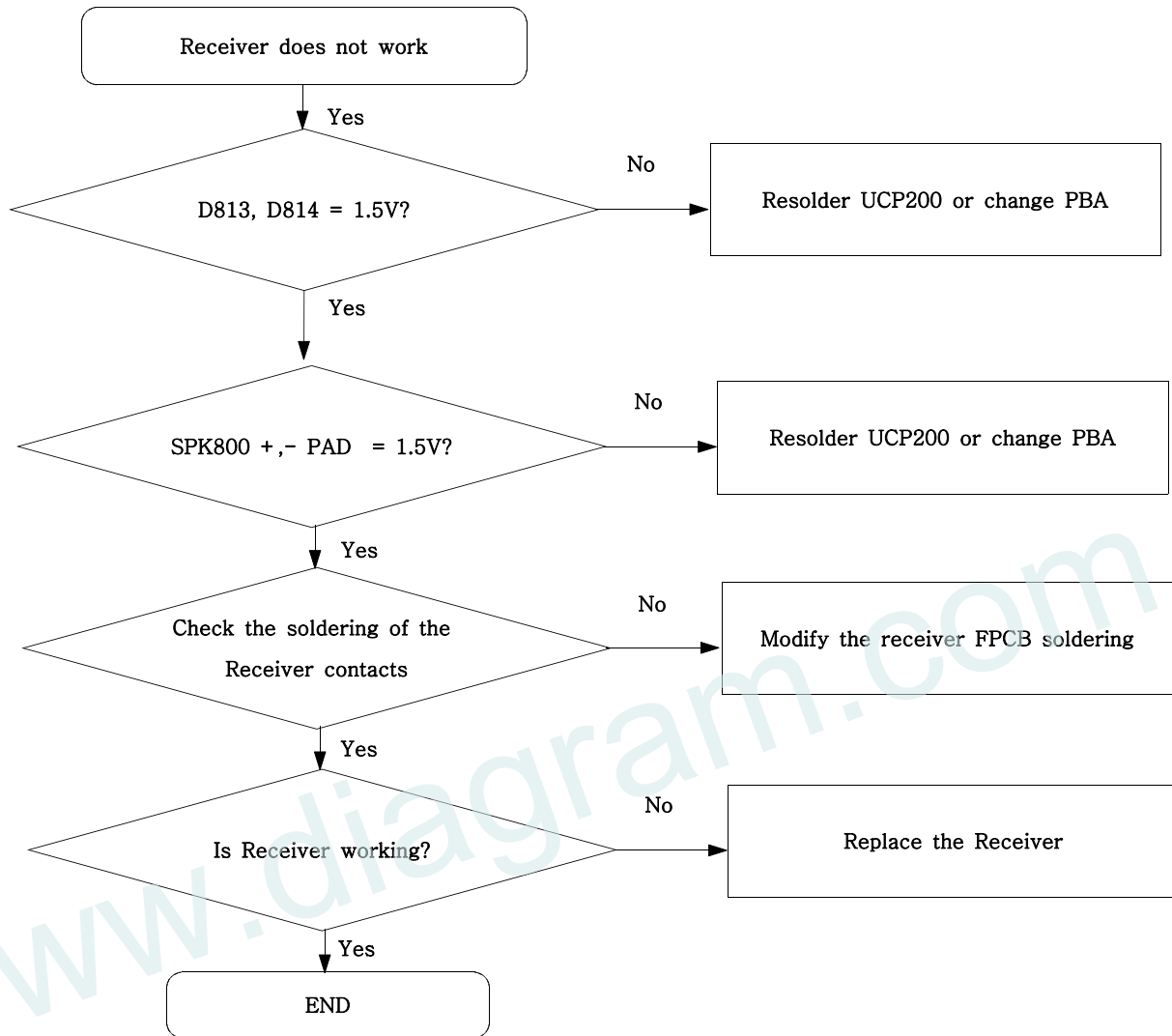

UCP200

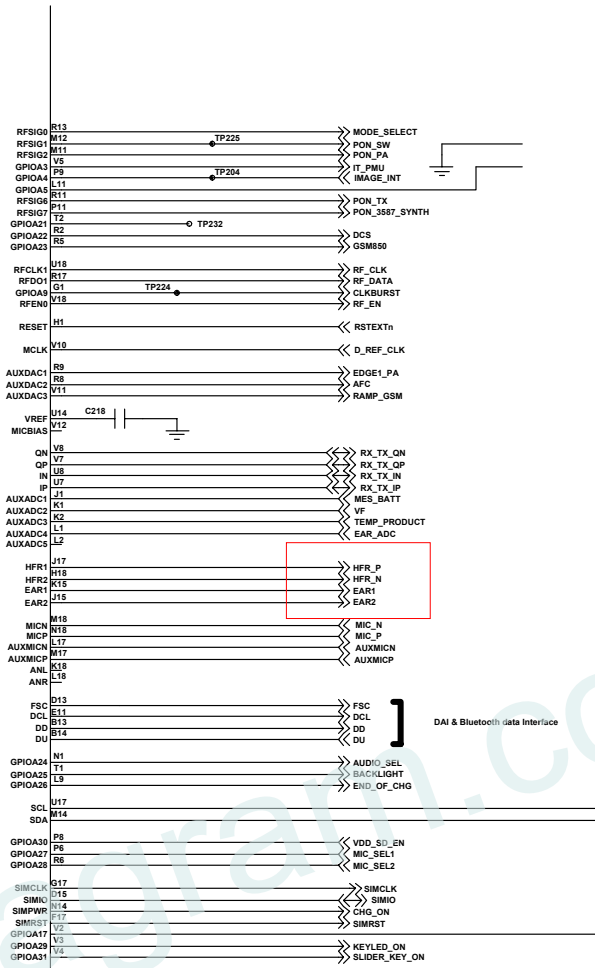

D813

HFR\_P

HFR\_N

D814

**RECEIVER**

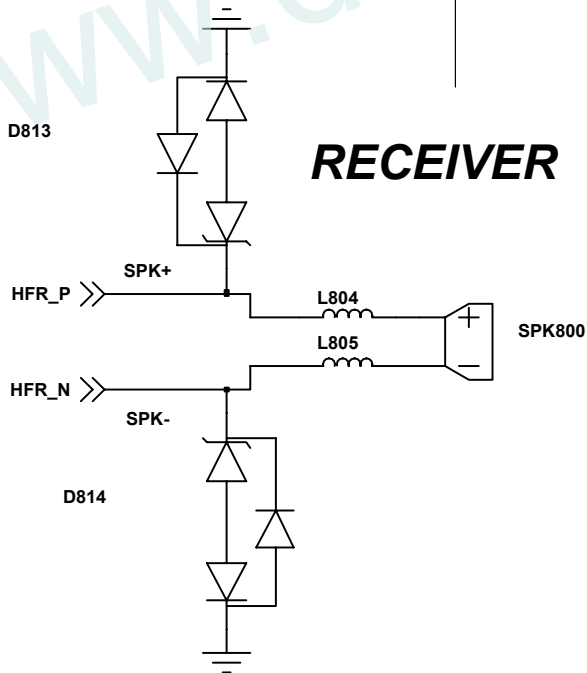

SPK800

D814 L805 D813 L804 D816 D815

7-10. Back Light (for LCD)

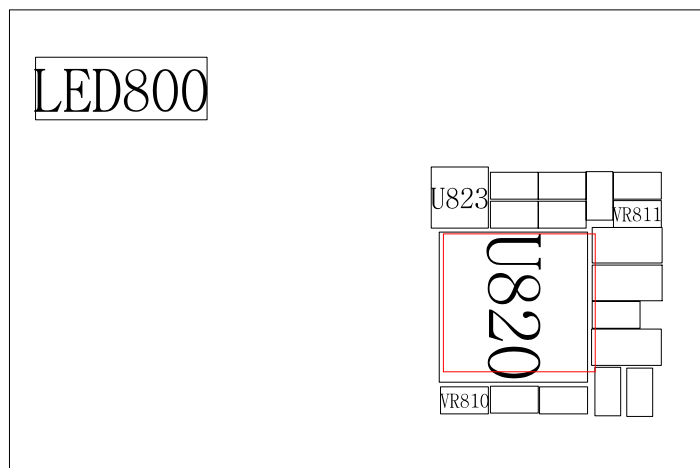
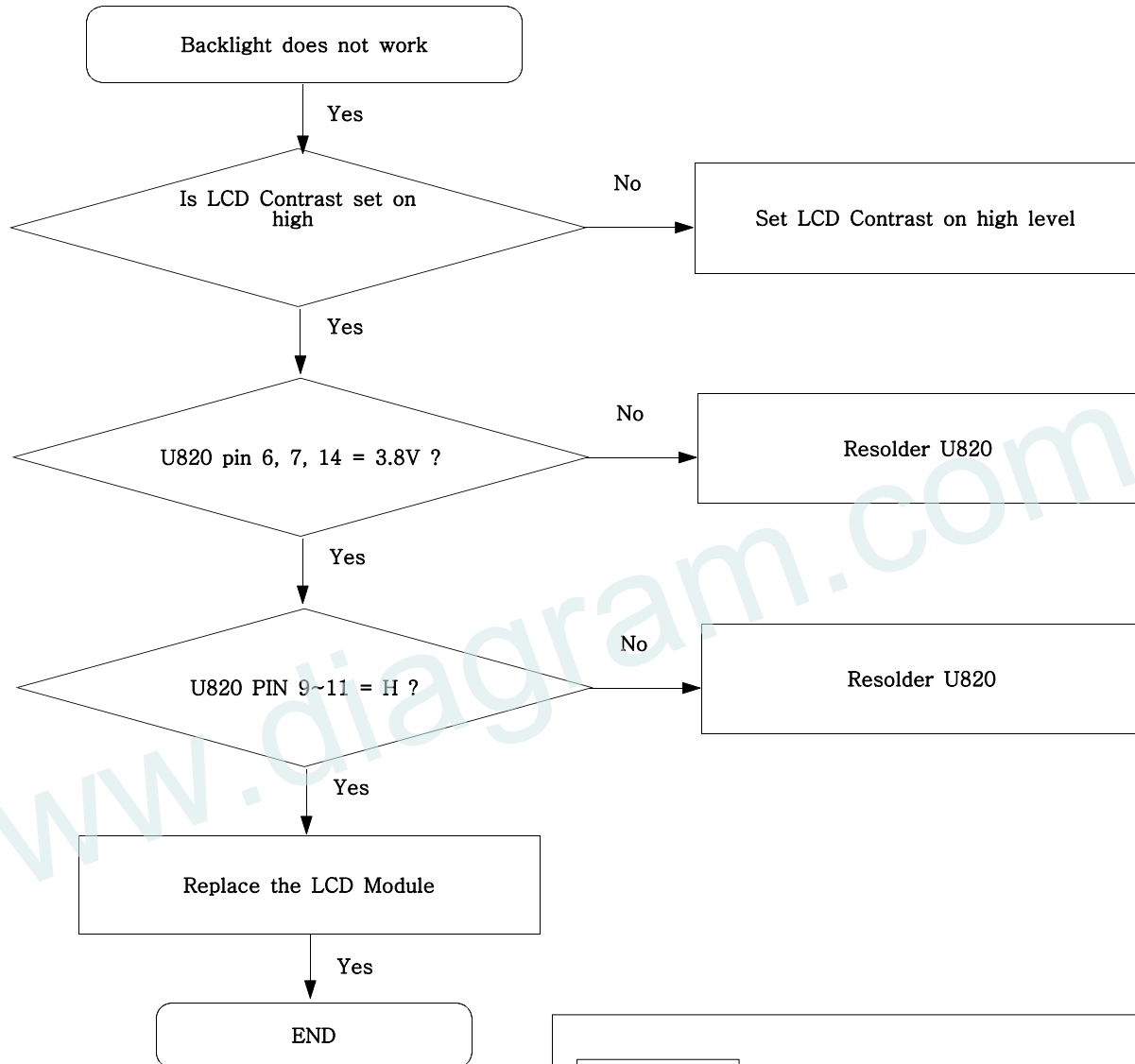

7-11. Key Back Light

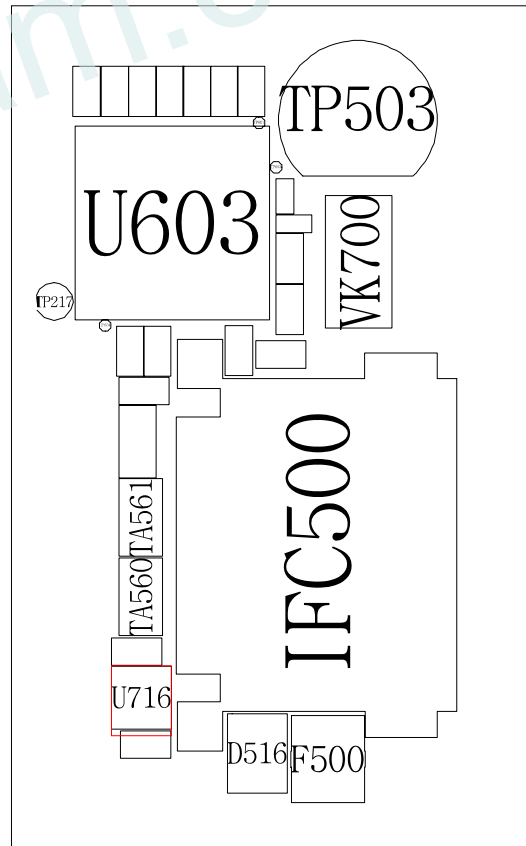
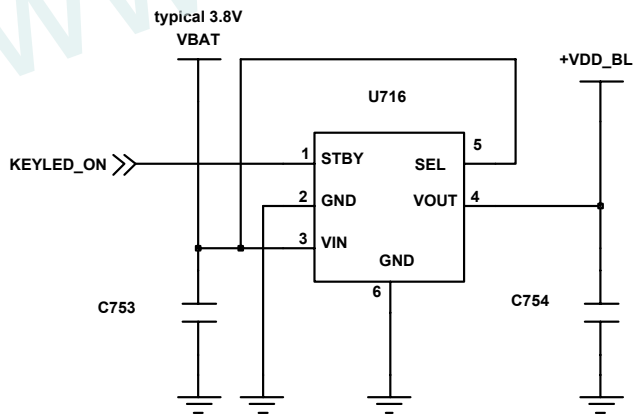
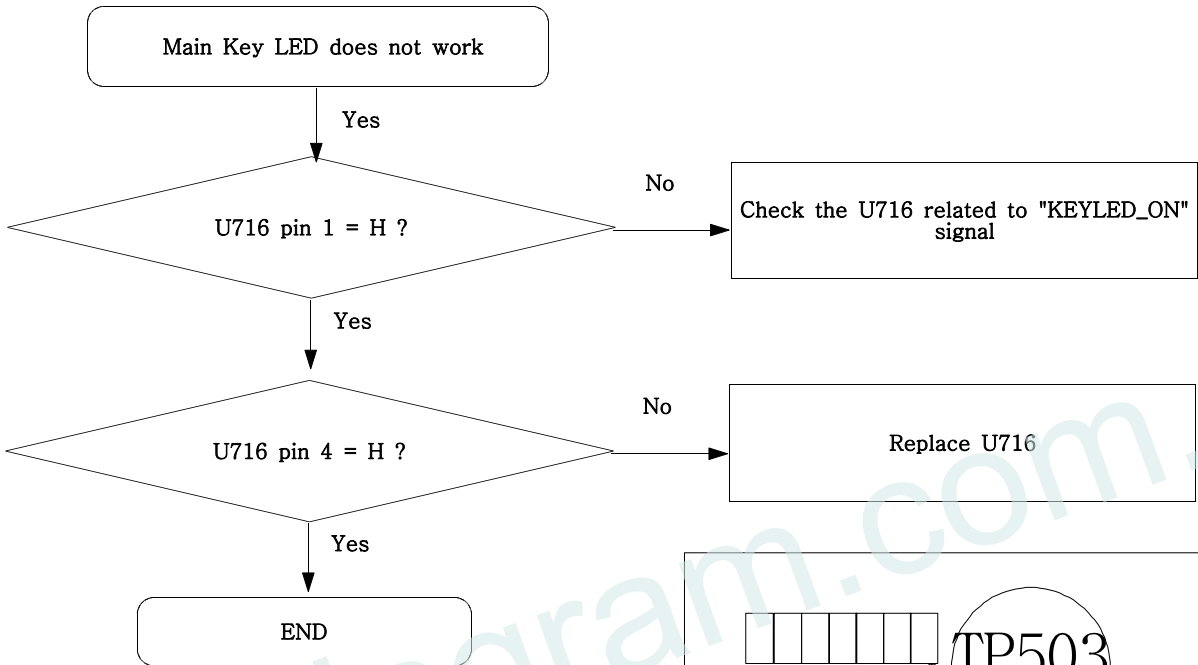

7-12. Sub Key Back Light

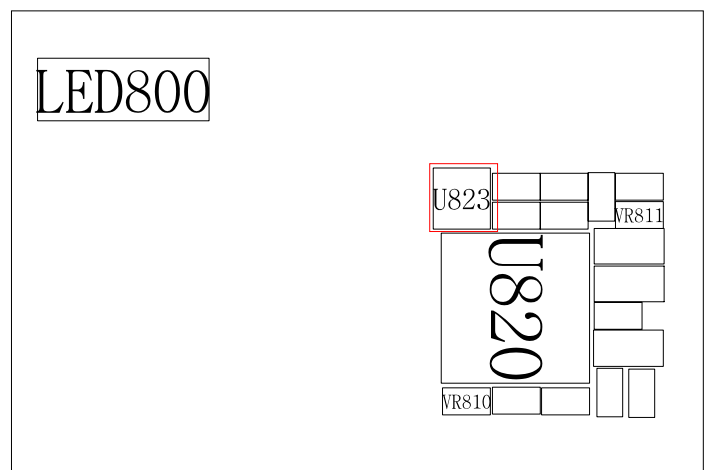
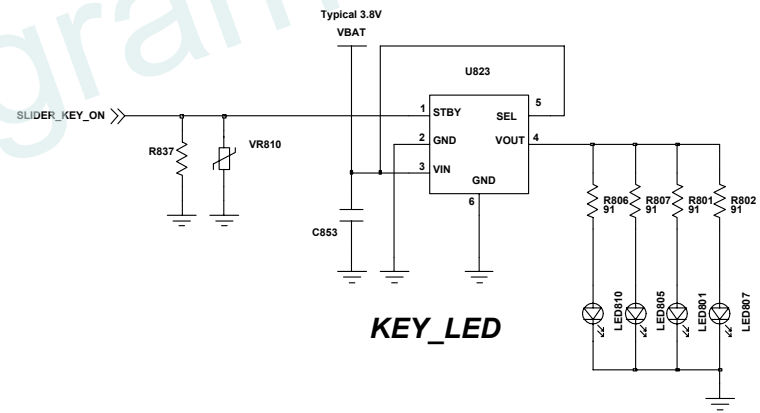
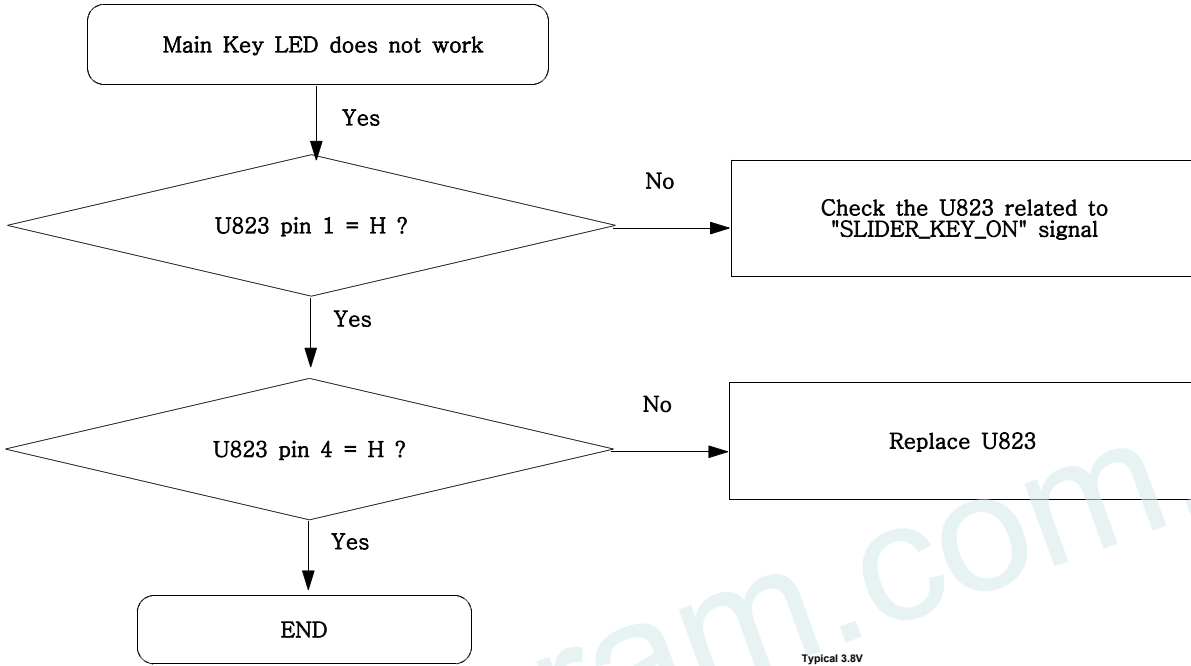

7-13. Camera part

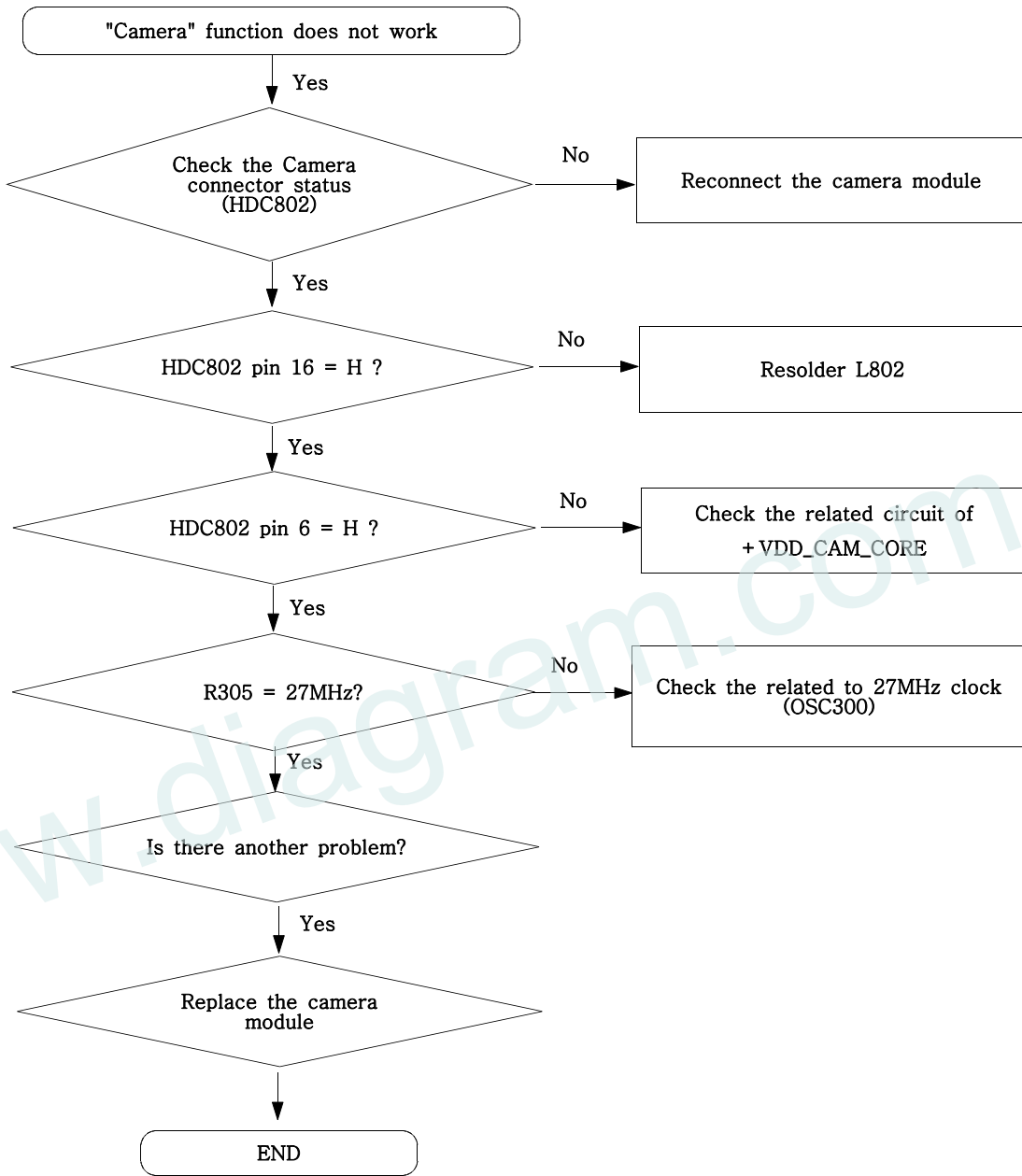



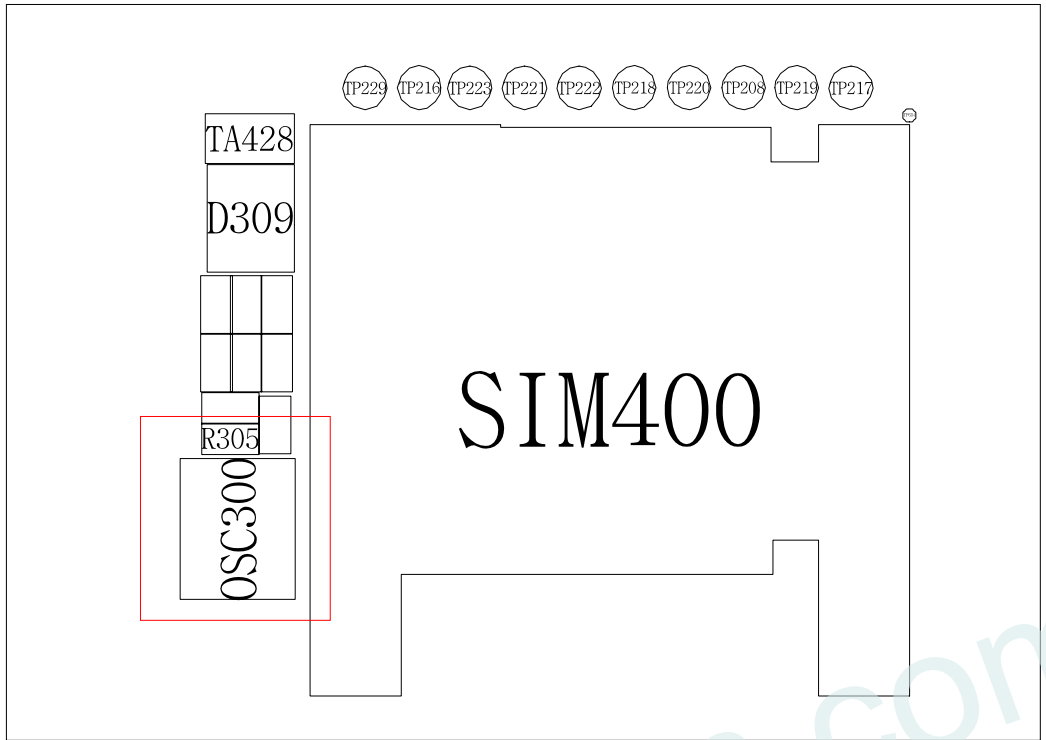



## 7-14. TV\_OUT Part

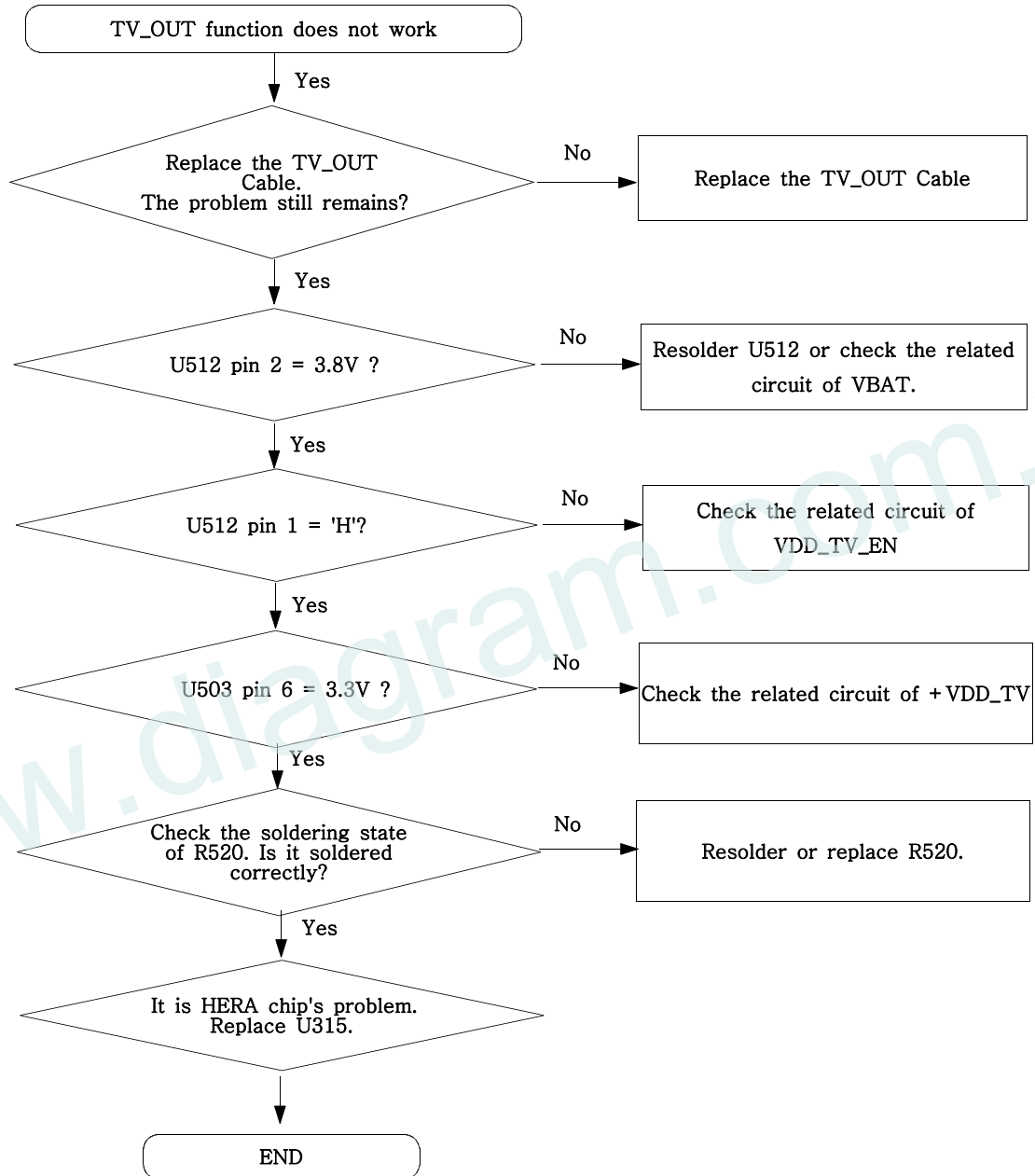

# Flow Chart of Troubleshooting

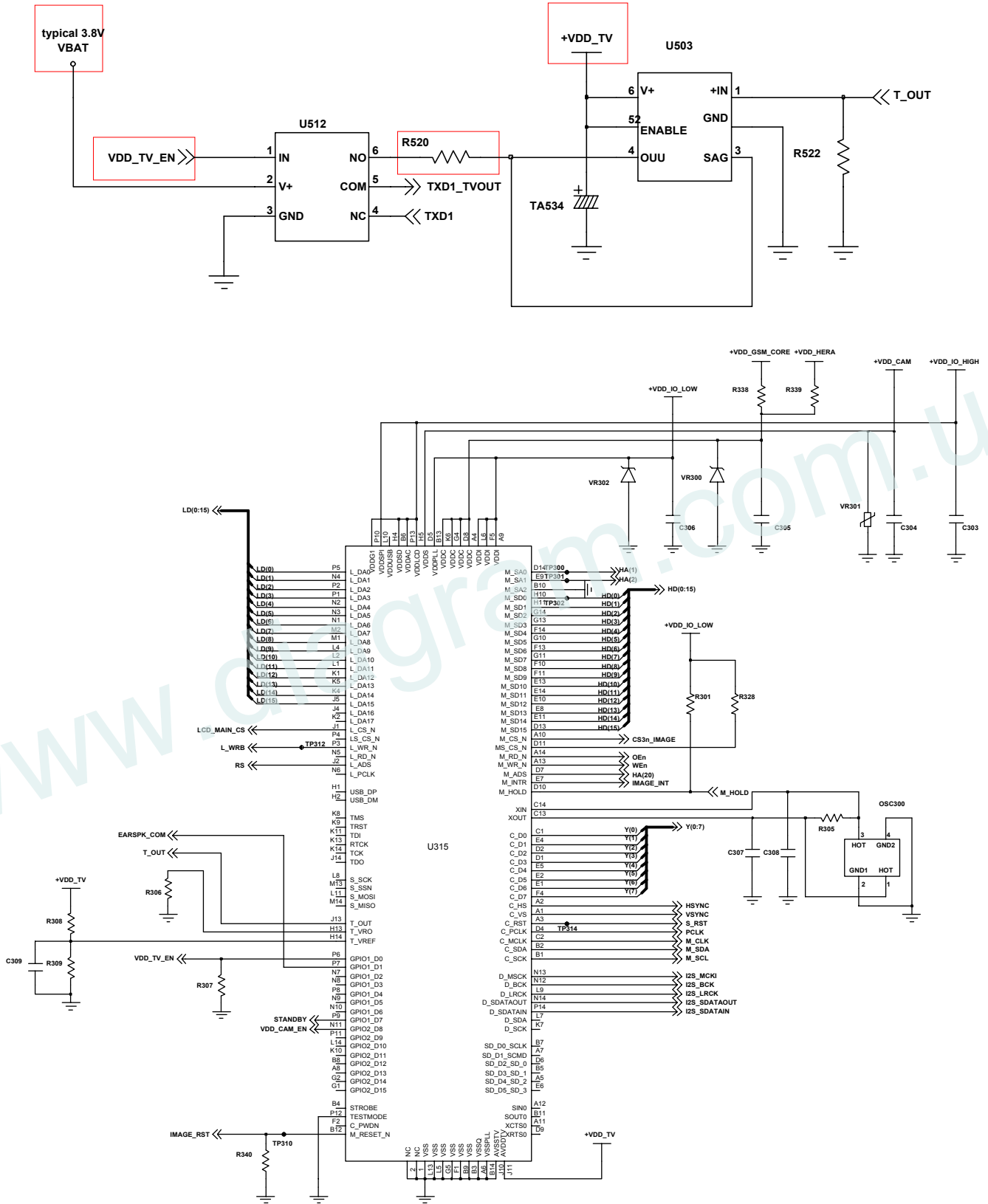

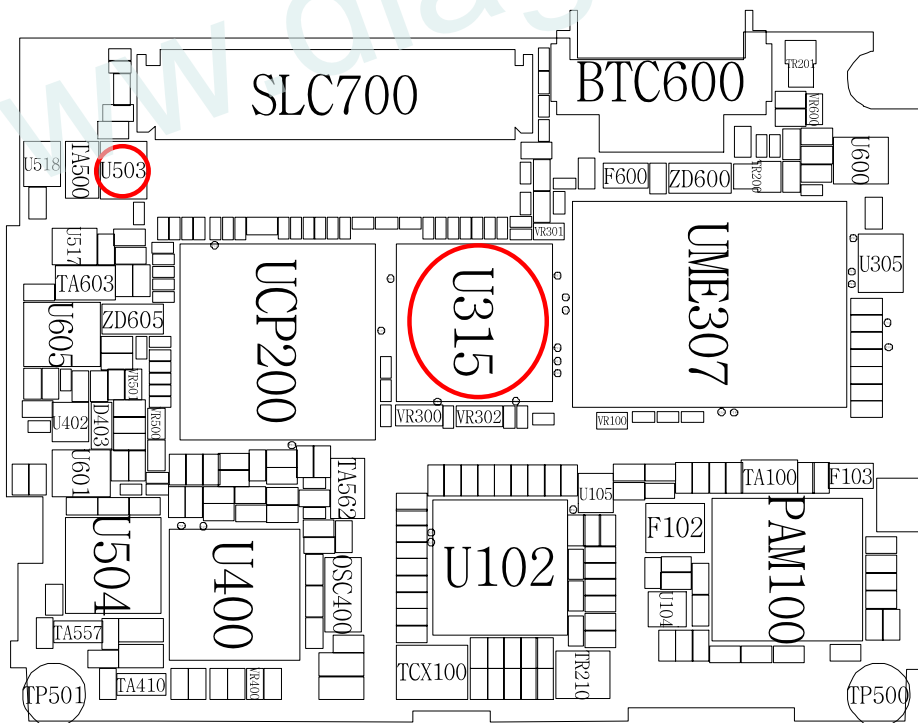
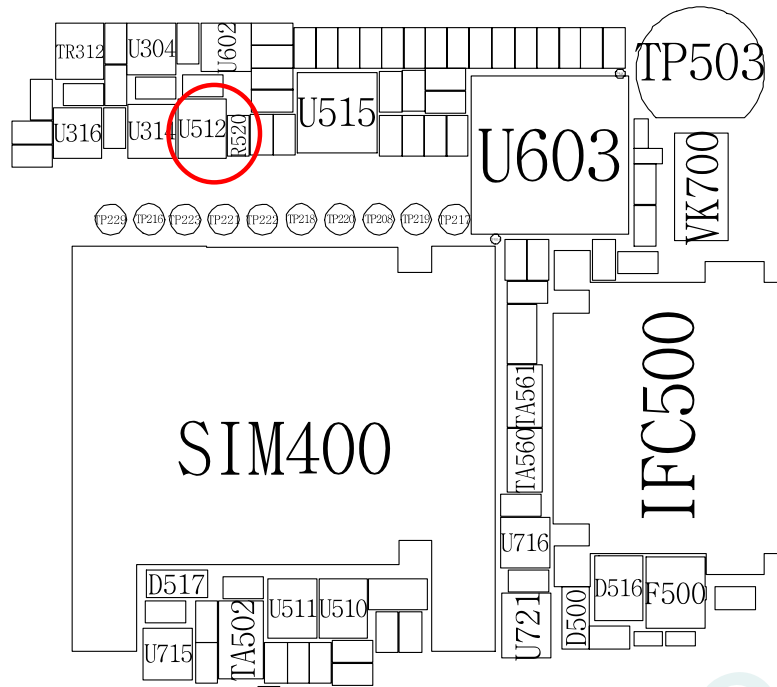

CN203

7-15. GSM850 Receiver

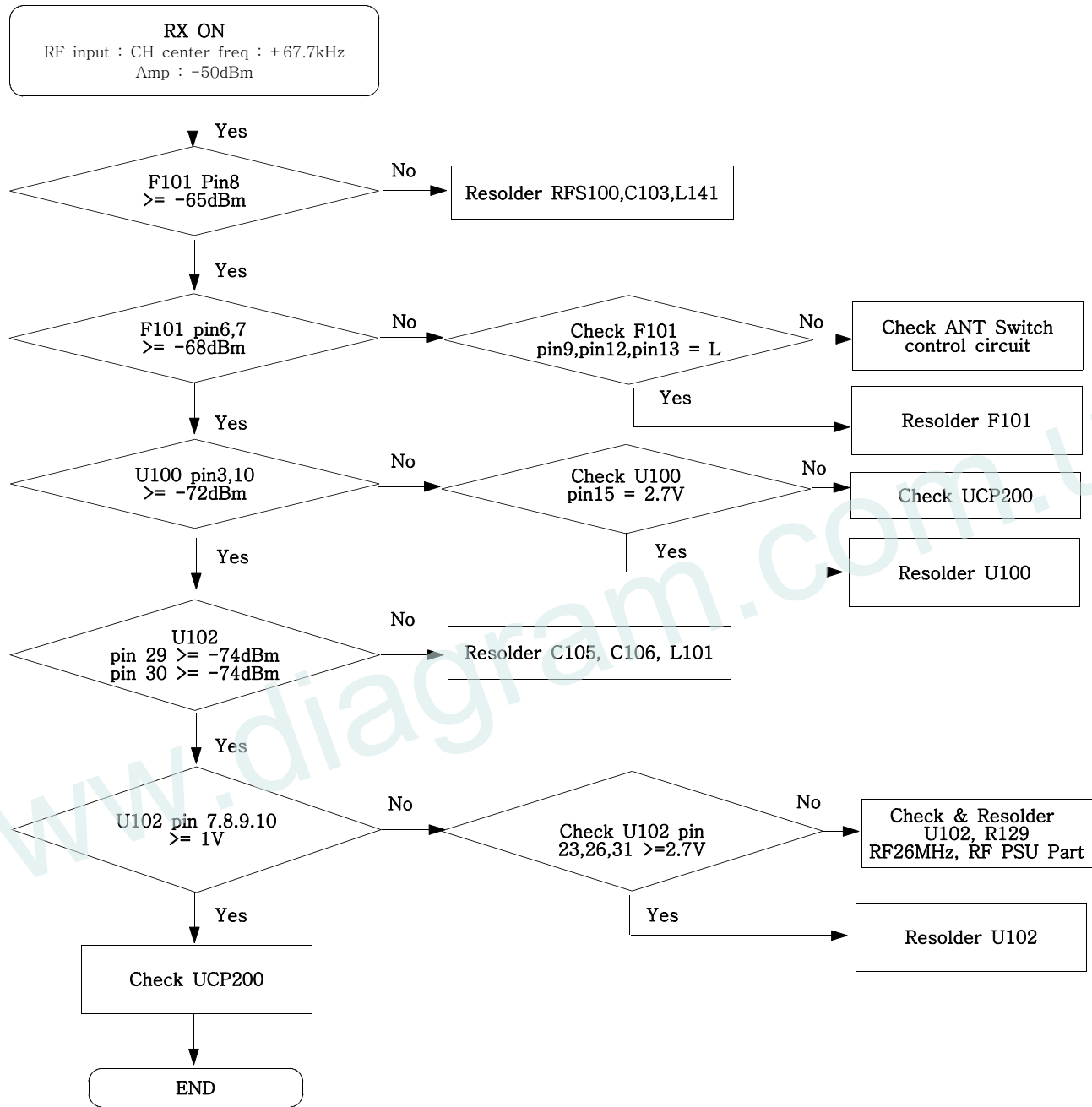

7-16. GSM850 Transmitter

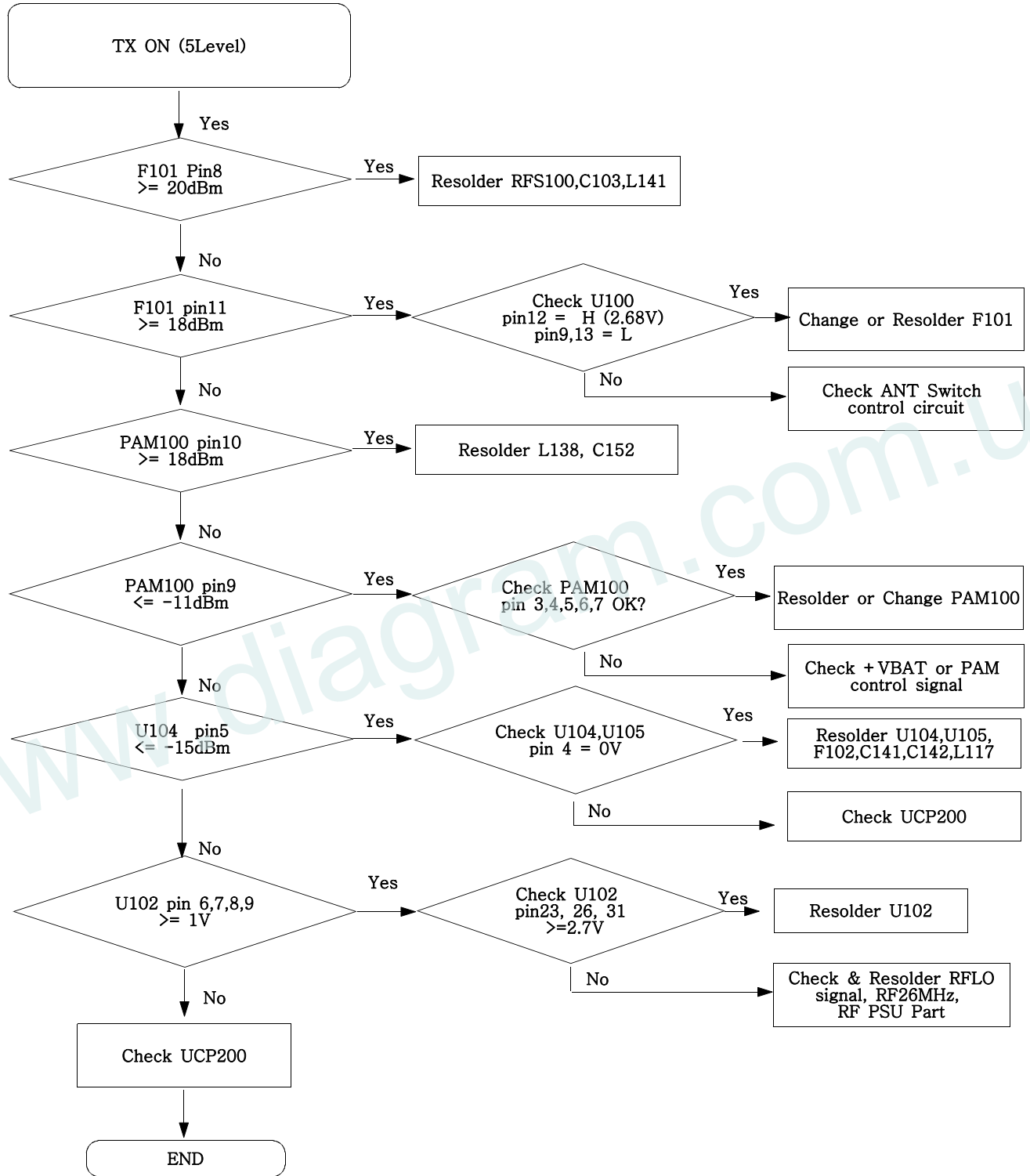

7-17. GSM900 Receiver

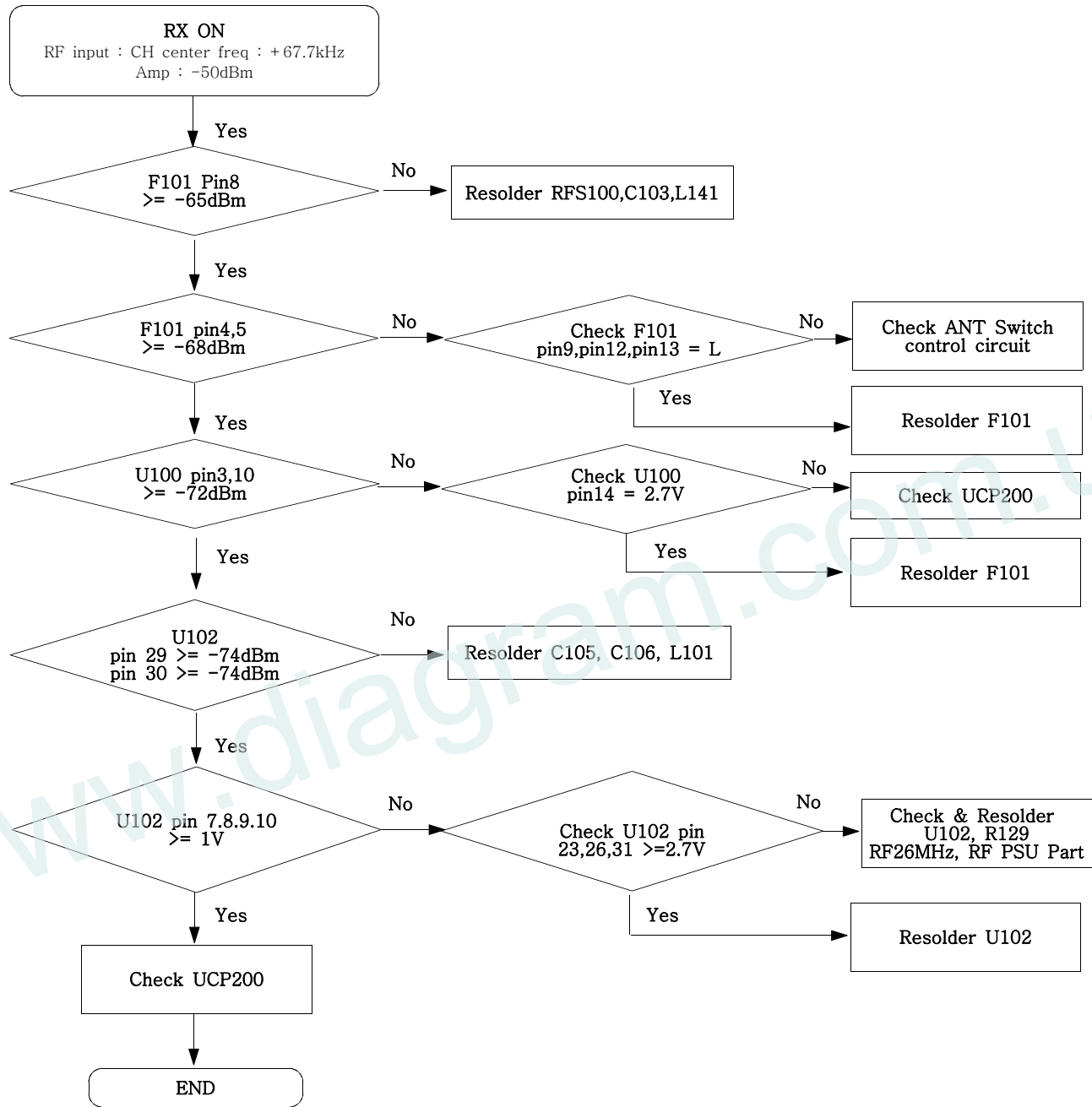

7-18. GSM900 Transmitter

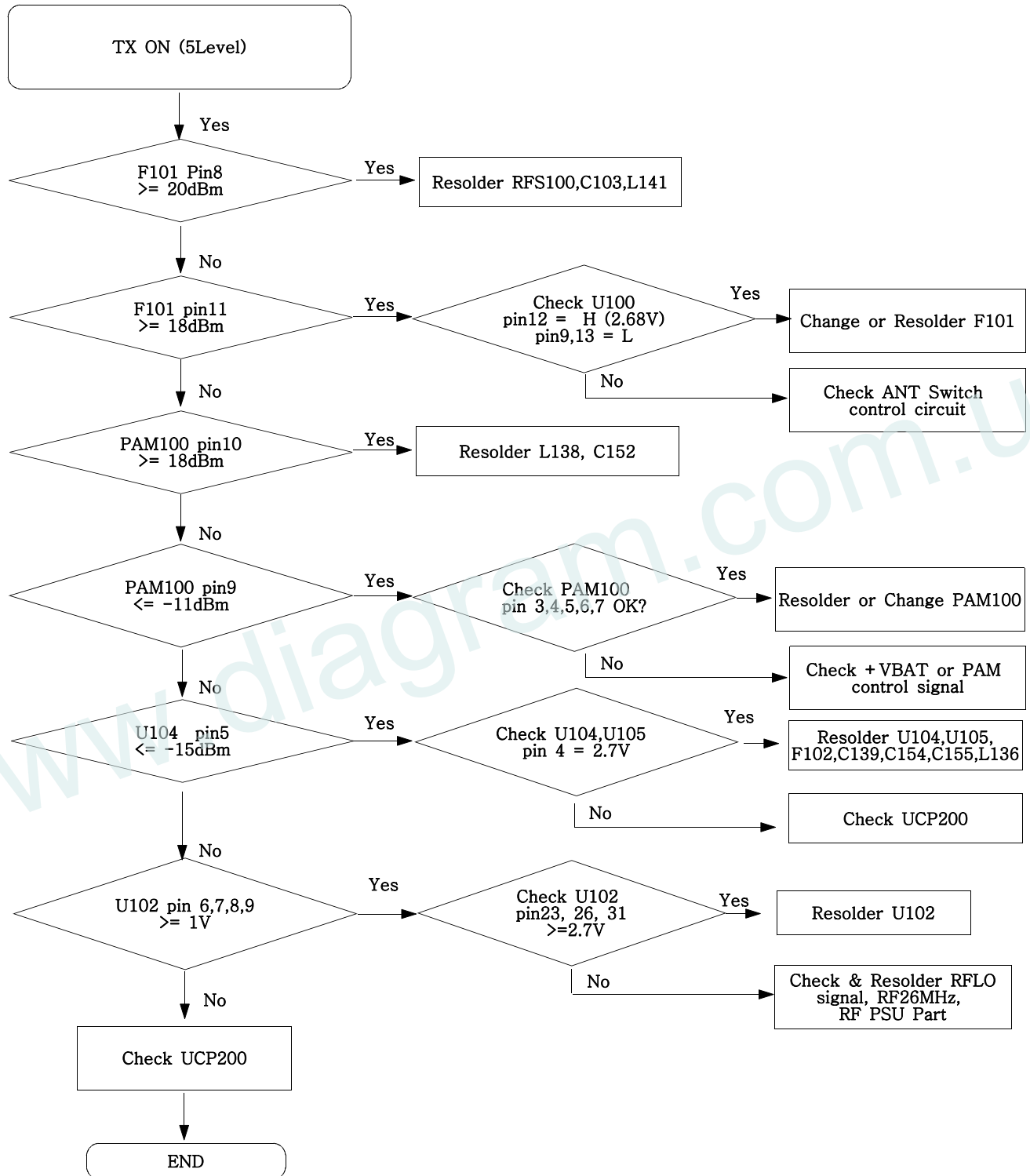

7-19. DCS Receiver

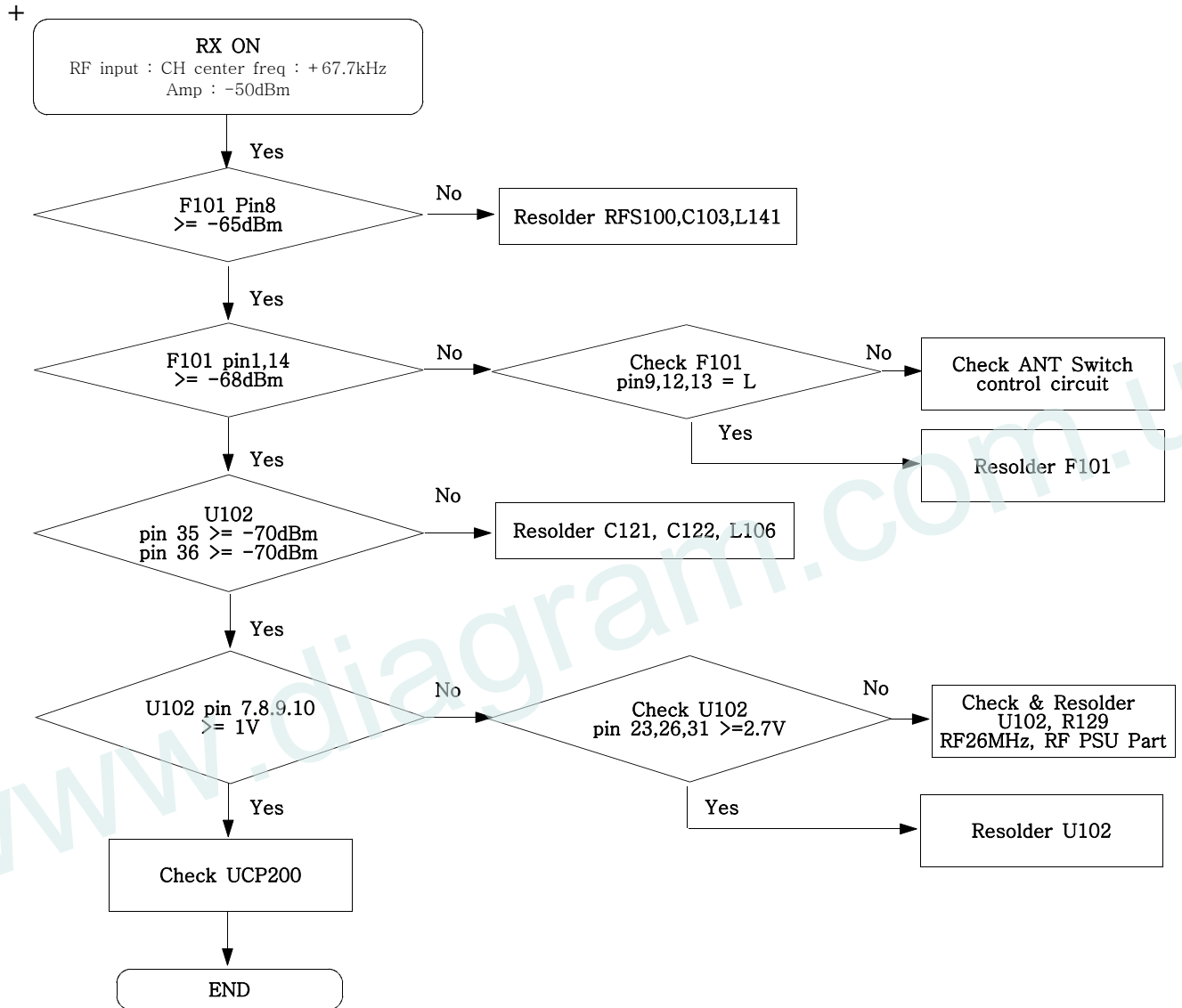



7-20. DCS Transmitter

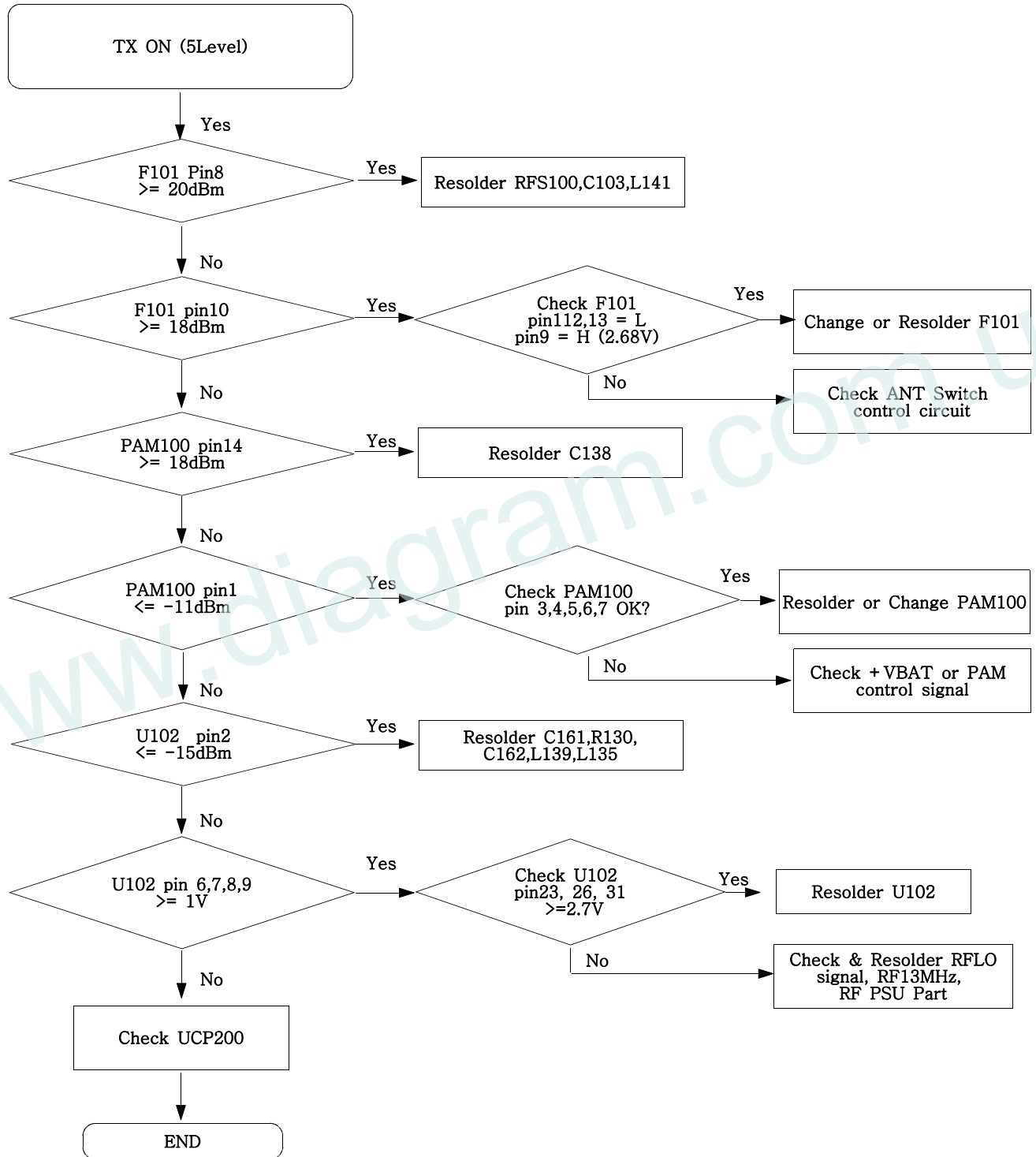

7-21. PCS Receiver

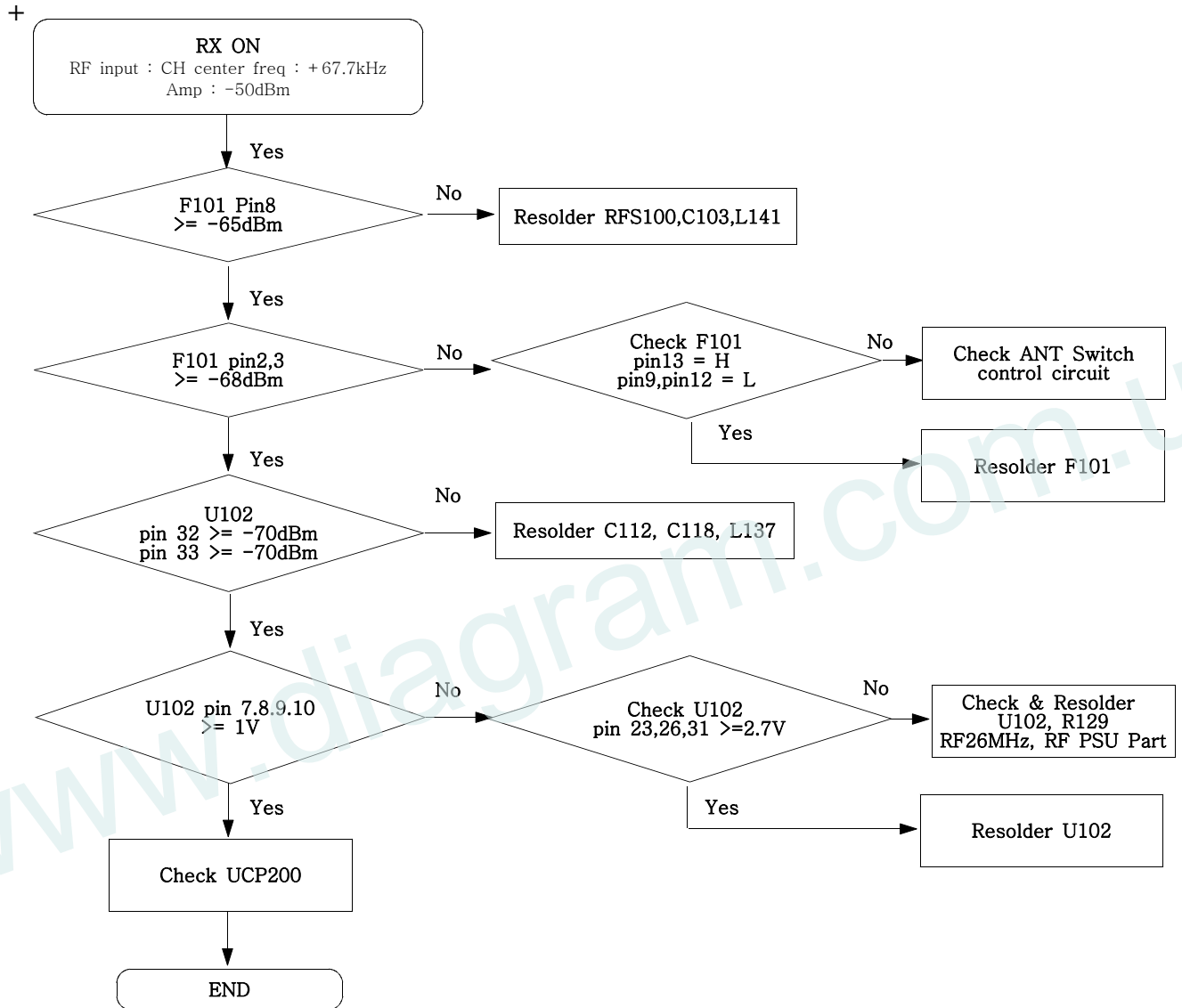

7-21. PCS Transmitter

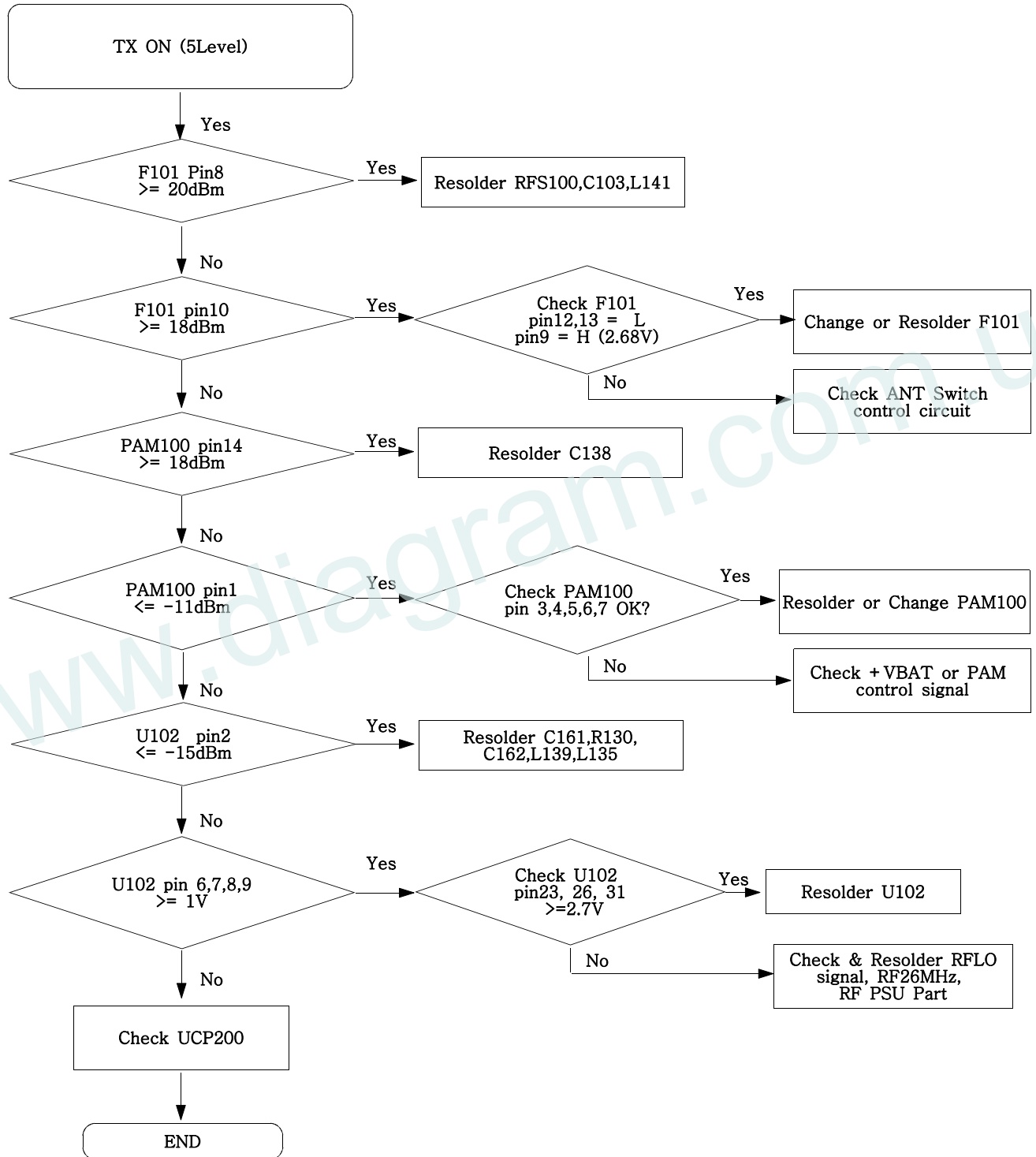

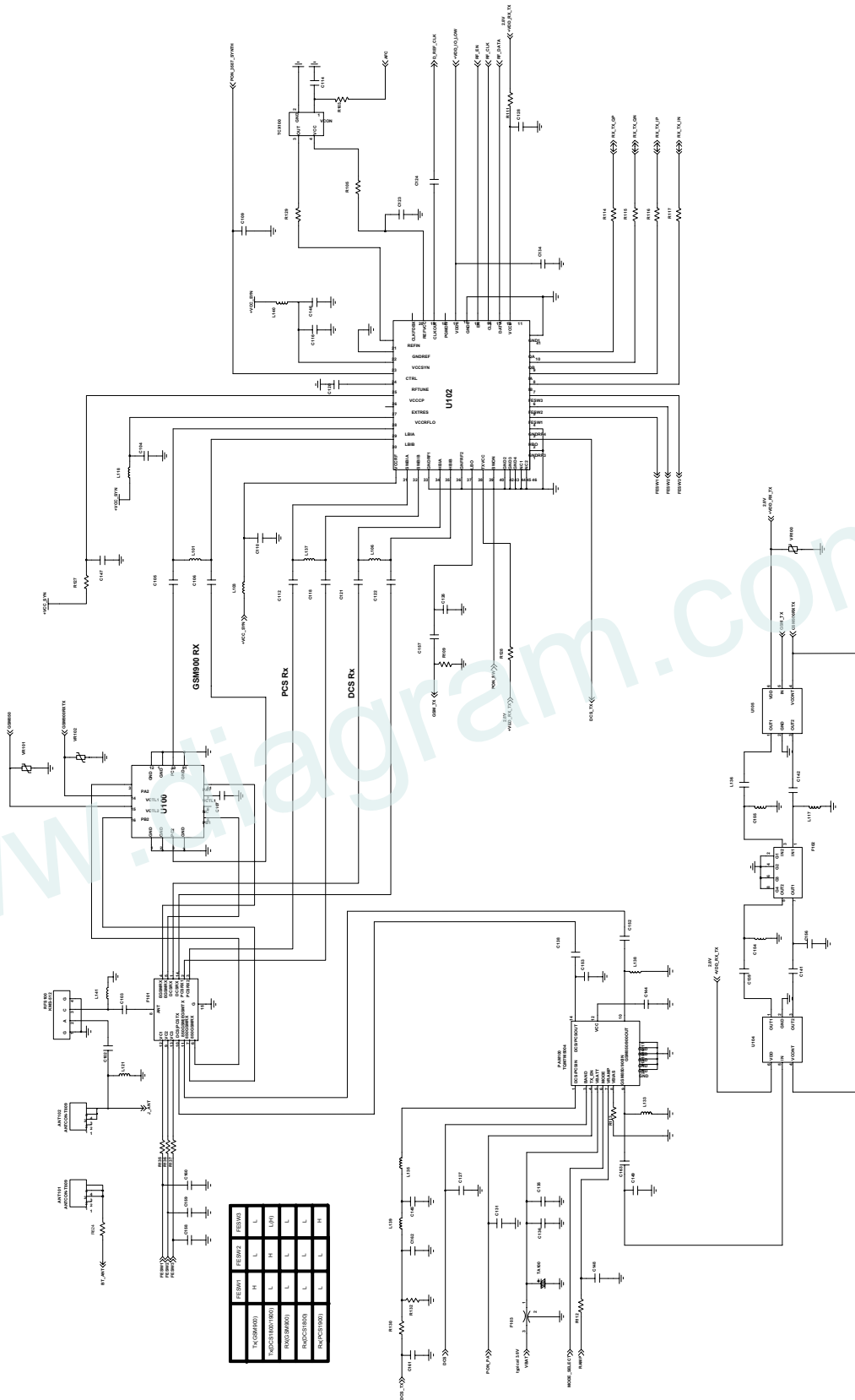

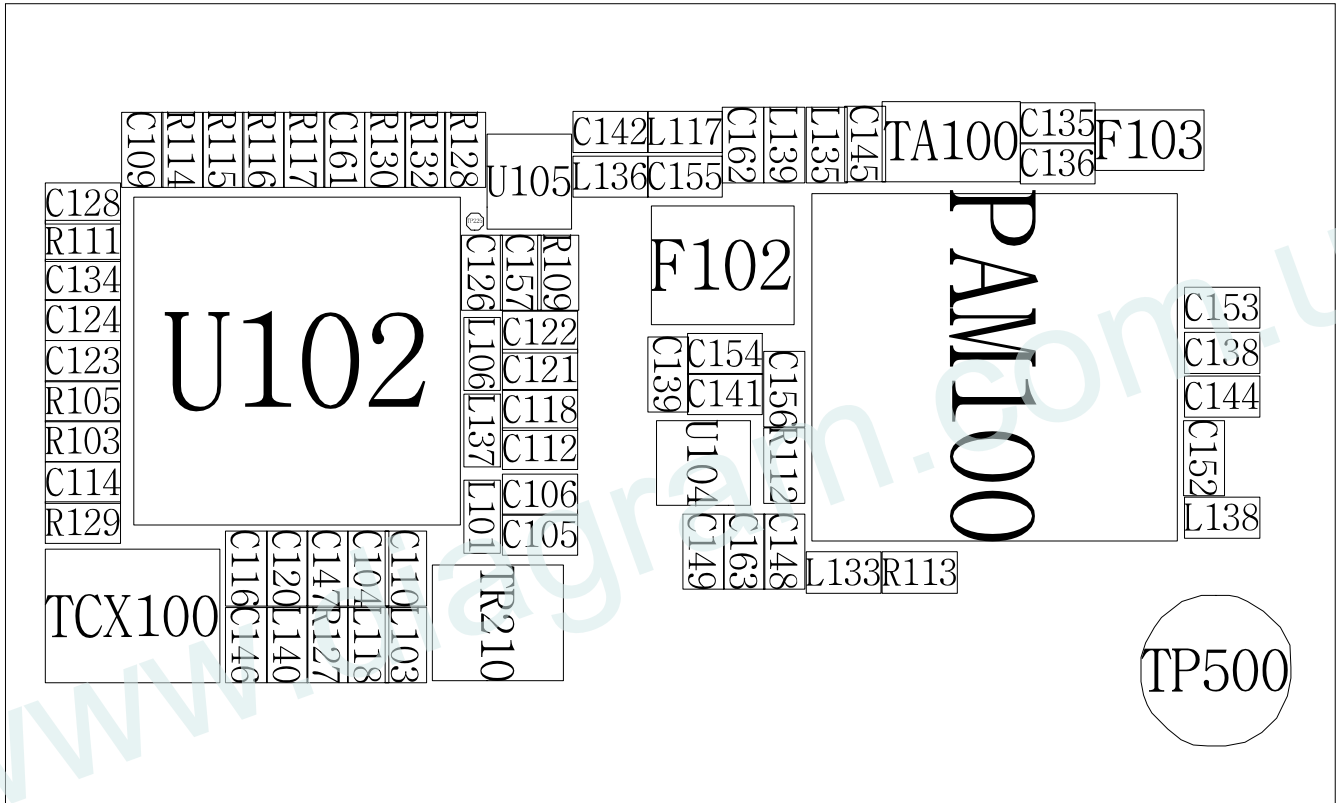

[www.diagram.com.ua](http://www.diagram.com.ua)