

Engineer	DATE	COMPANY NAME
Checked by	DATE	Address
DESIGN NO.		CITY
OPERATOR/CHECKER		
DATE/VERSION		
SGH-D520 REV 1.8		

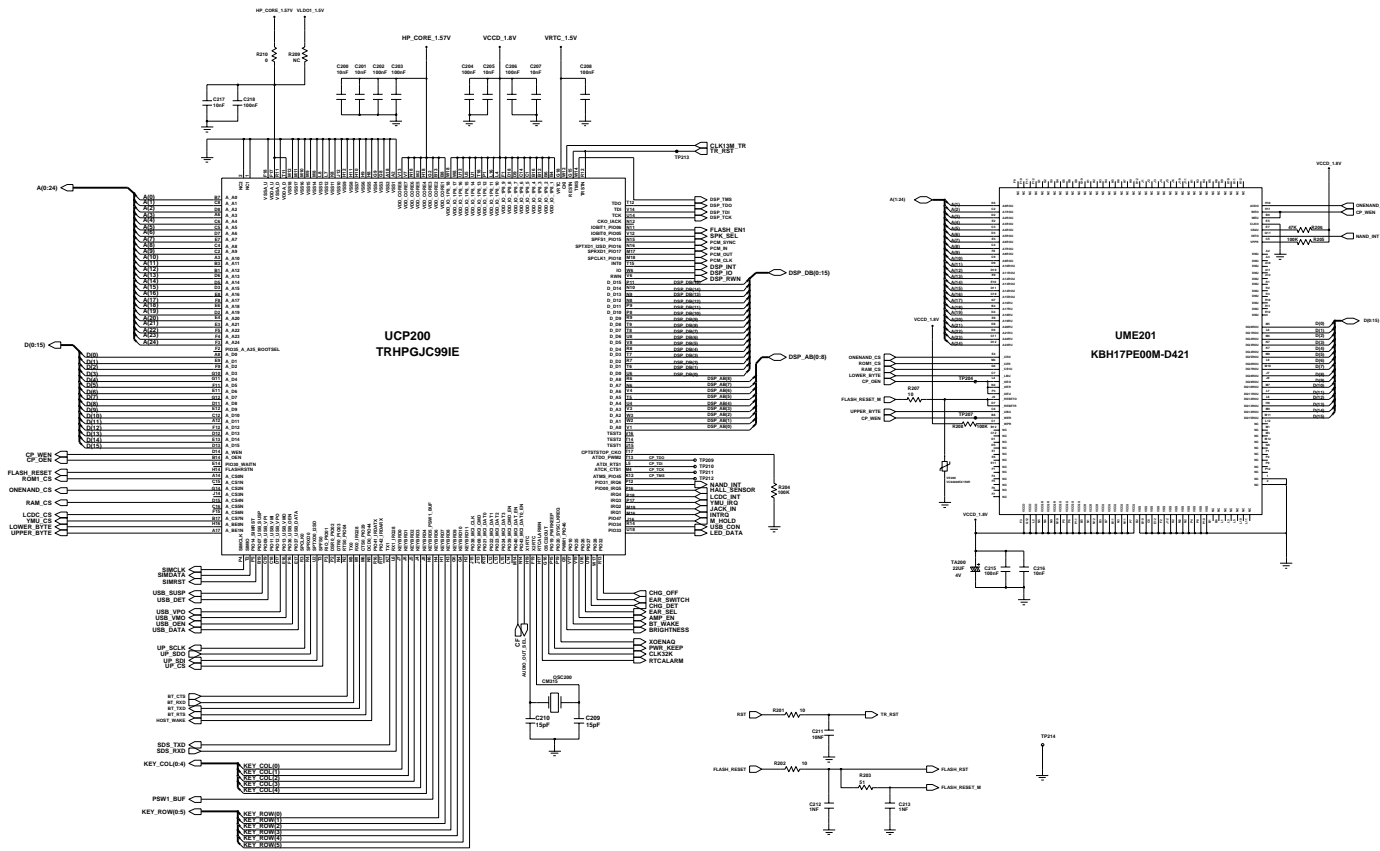

Engineer	Checked	COMPANY NAME
Drawn by	Approved	Address
Rev	City	
SGH-D520 REV 1.8		

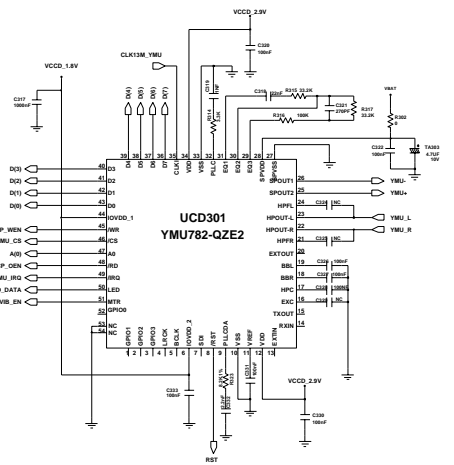
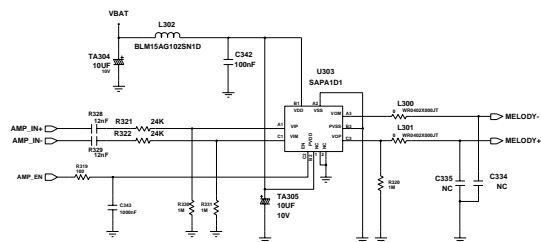
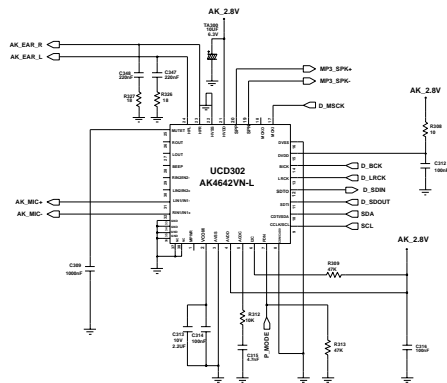
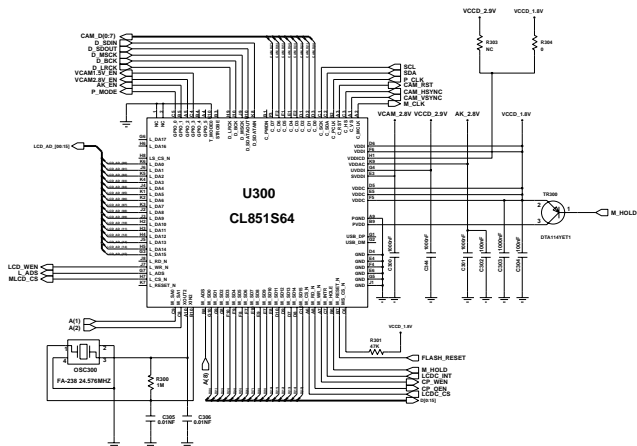

BOARD HOLE



Engineer	COMPANY NAME
Checked by	Address
Rev. No.	City
DATE	
DATE	SGH-D520 REV_1.8
DATE	

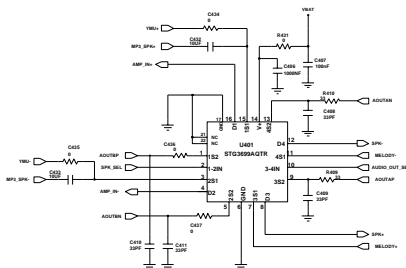
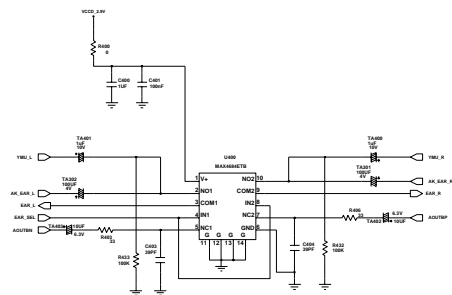

AUDIO SW

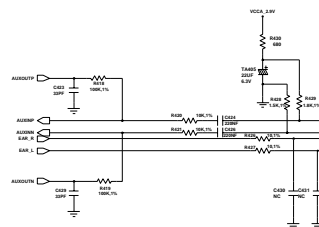
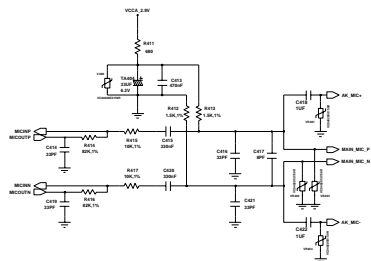

COMPANY NAME	
Engineer	_____
Checked by	_____
Drawn by	_____
Approved by	_____
Project No.	_____
Rev.	_____
SGH-D520 REV_1.8	

< KEY MAP >

	CODE	CD1	CD2	CD3	CD4
ROW1	1	4	7		END LP
RET1	2	5	8	0	END DOWN
RED	3	6	9	#	
RED	MODE	CLR	ENTER/OK	CAMERA	
ROW4	LEFT	DOWN	RIGHT		
ROW5	MODE	UP	END		

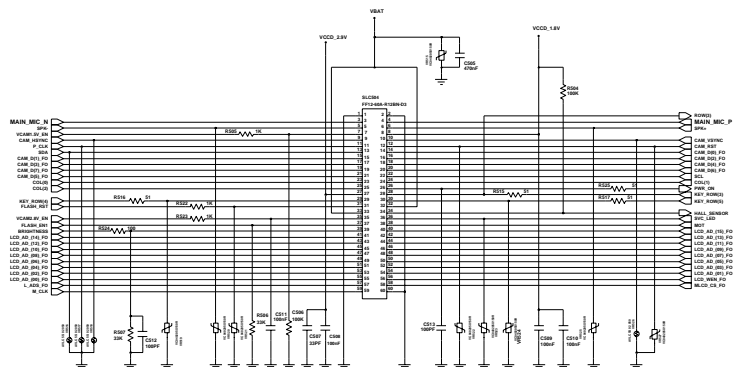
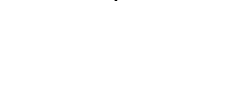
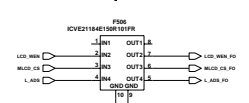
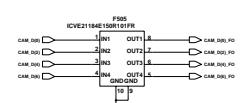
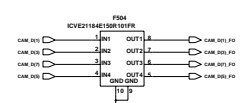
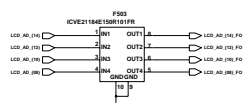
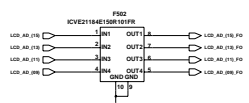
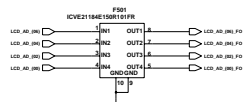
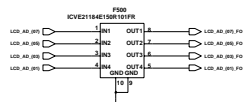
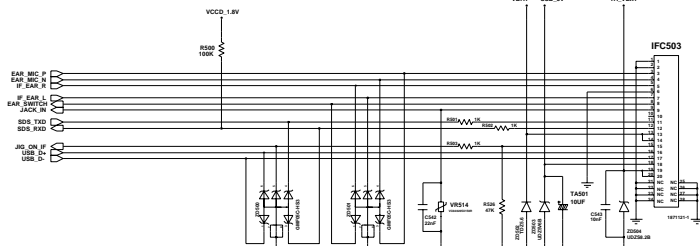
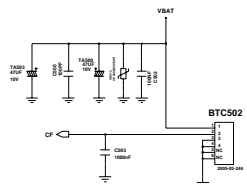
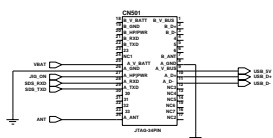
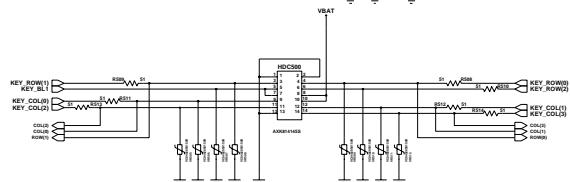
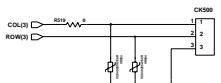
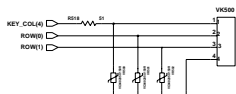

LED CONNECTION

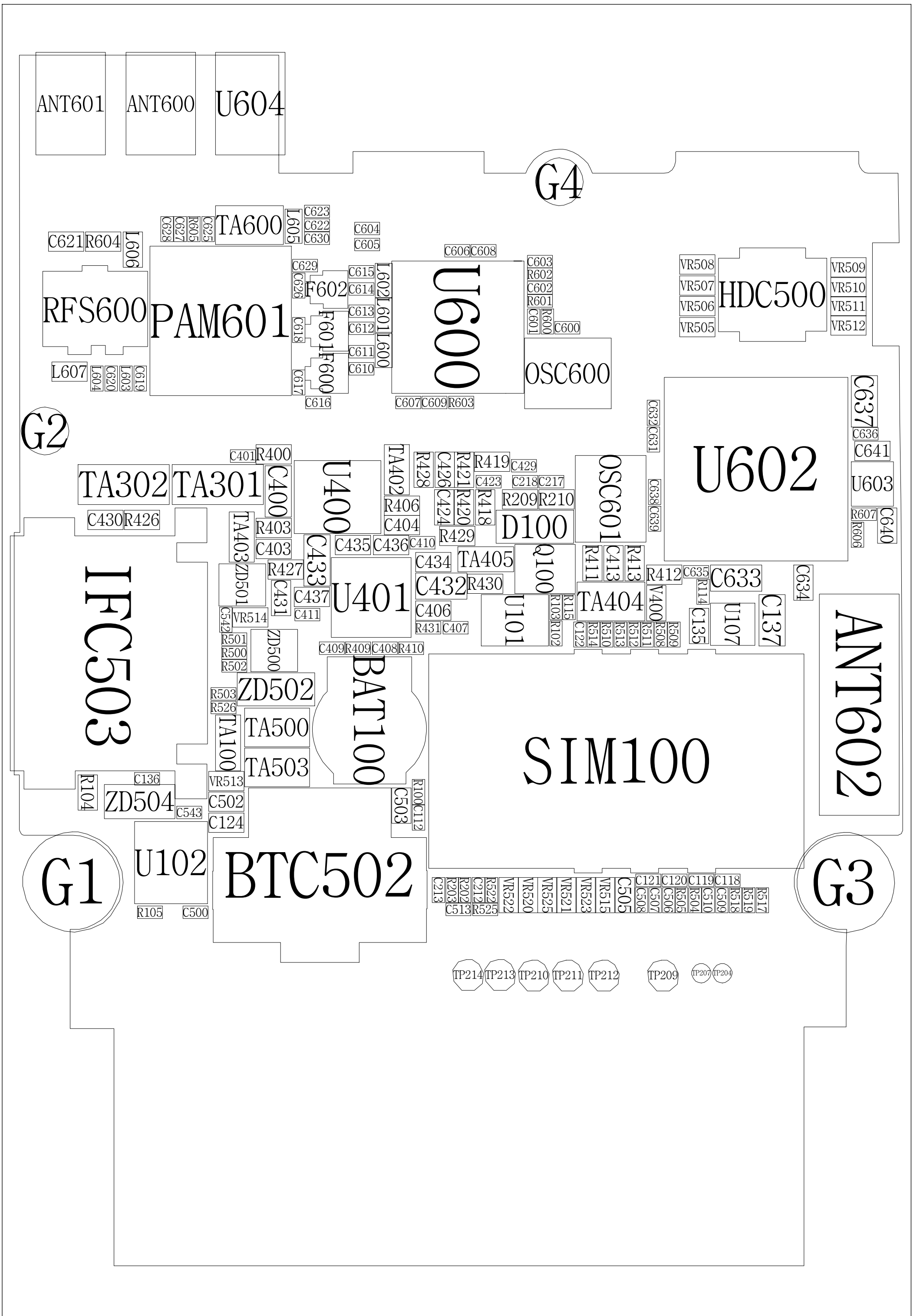

ANT601

ANT600

U604

G4

TA600

C621 R604 L606

C623 C622 C630 L605 R605 C625 C627 C628

C604 C605

U600

C606 C608

C603 R602 C602 R601 C601 R600 C600

VR508 VR507 VR506 VR505

HDC500

VR509 VR510 VR511 VR512

RFS600

PAM601

C629 C615 L602 L601 L600 C614 C613 C612 C611 C610 C617 C618 C616 F602 F601 F600

OSC600

C607 C609 R603

G2

TA302 TA301

C401 R400

U400

TA402

R419 C429 R421 R420 R418 R428 C426 C424 R429 R419 C423 C218 C217 R209 R210 R418 R413 R411 R412 C635 R114 R115 R103 R102 C122 R509 R508 R511 R512 R513 R510 R514 R515

D100

OSC601

U602

C637 C636 C641 U603 R607 R606 C640

C430 R426

IFC503

TA403 ZD501

U401

TA405

Q100

TA404

U107

C137

ANT602

R427 C433 C437 C431 C411 C403 C404 C406 C407 R431 C409 R409 C408 R410

BAT100

SIM100

C633 C135 U101

ZD502

TA500

TA503

R104 ZD504 C136 C543

TA100

VR513 C502 C124

BTC502

U102

R105 C500

R100 C112 C503

C213 C212 R203 R202 R201 R522 R521 R520 VR522 VR521 VR525 VR523 VR515 VR513 C505 C508 C121 C120 C119 C118 R517 R519 R518 C509 C510 R504 R505 C507 C506 R507 R508

G3

G1

TP214 TP213 TP210 TP211 TP212 TP209 TP207 TP204

CK500

VR527
VR526
VR403
R515R506
VR504
VR524
VR503
VR402

F504 F505 F503 F501 F502 F500 F506

VR501
VR502
VR519
R516
VR516VR518

SLC504

C138

UME201

TA200 R301 C300 C301 C302 C303 TR300
R208 R524 C511 R320 R329
R206 R523 L301 R331 R322
R205 C512 C335 L300 U303 C342 L302
C334 TA305 TA304
VR517 R328 R321 R330

U300

ZD503 TA501 C317 C333

C200 C206 C216 C215 R207 U605 C102 C103 C101 C116 C100 C306 R300 C305 C304 R304

UCP200

U100

OSC300

UCD301

C131 U106 L101 C132 L100 U105 TA103 U103 C422 VR404 VR401 C418 C416 C309
C130 OSC200 C210 C208 C203 F101 C343 R108 TA101 TH100 C114 C115 R101 R107 C316 R309 R313
C209 R319 C211 R112 C126 R111 TA101 C115 R101 R107 C316 R309 R313 C109 C117 C110 C113 C105 R106 C108 C107 C106
C344 R204 C205 C104 C104 C111 R302 TA303 R308 C312 C324 C325 C326 C327 C328 C329 C330
C204 C207 C201 C202 R415 C415 TA303 C322 R414 C414 C417 R316 R417 C420 C321 R317 R315 C318 C314
R416 C419 R317 R315 C318 C314 C319 C320 R303 R304 C331 R323 C332
C347 R326 C348 R327 TA300 R433 R432 C129 TA401 TA400 U104 C128 R113
C328 C329 C330

VK500