

D500 Rev3.2 SLIDER

ASSY1

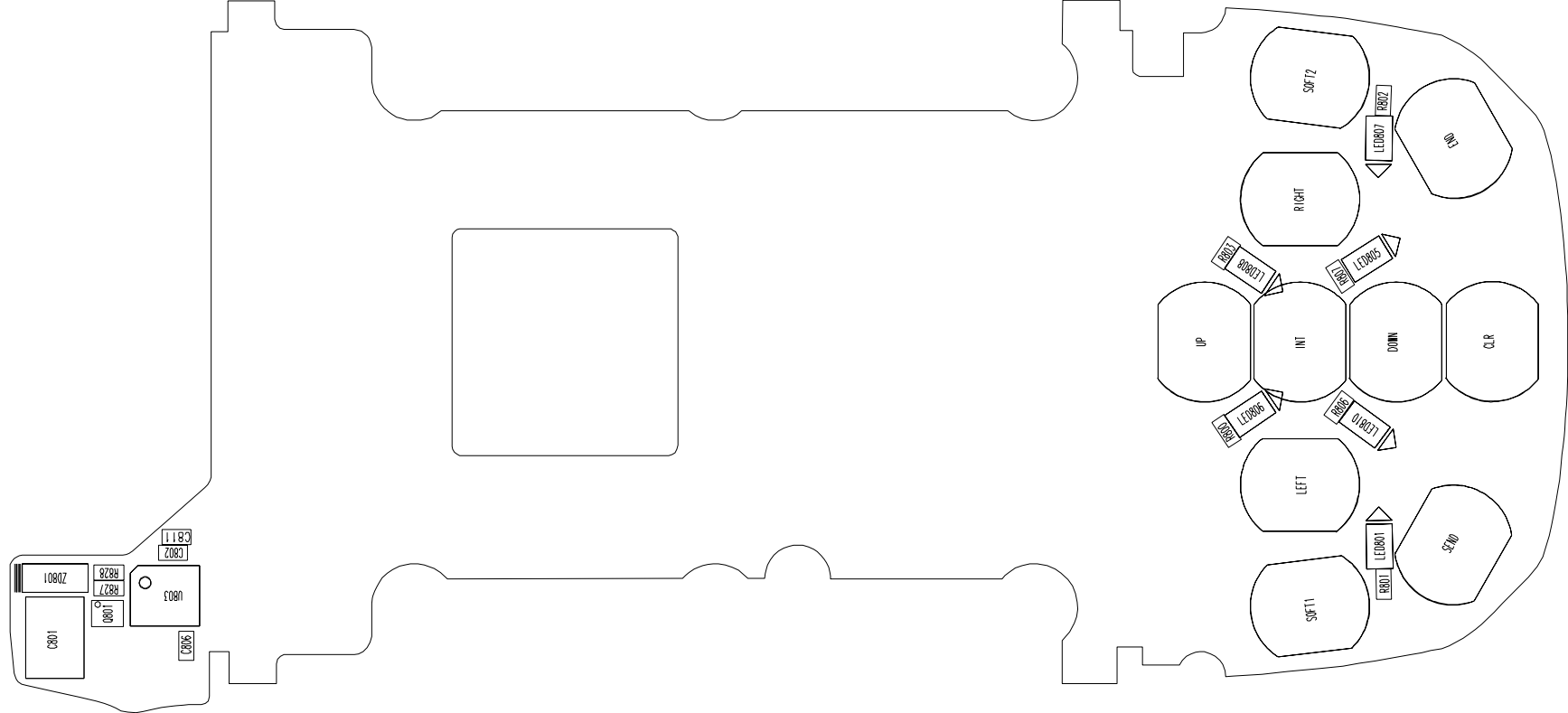

D200 Rev3's ST/DEF

ASSY2

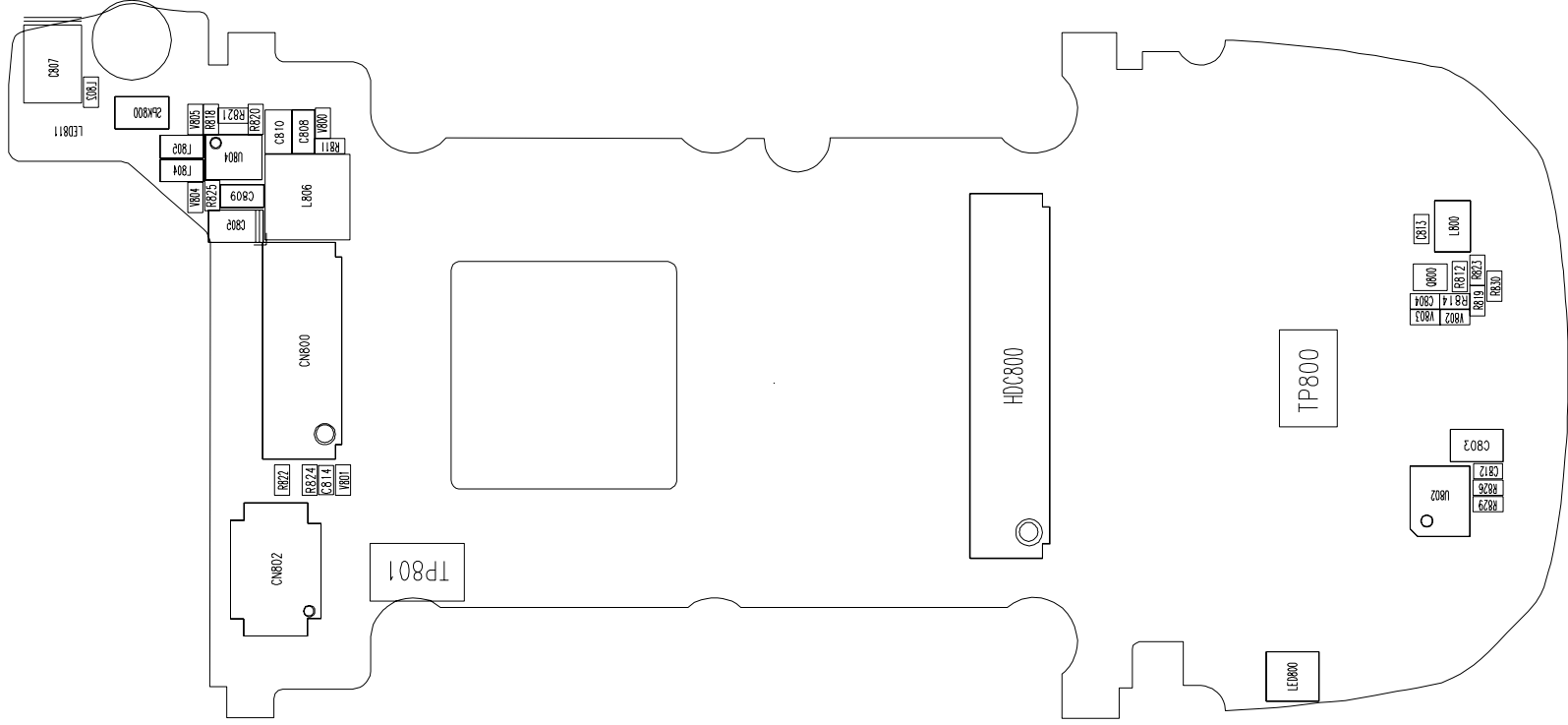

CN801

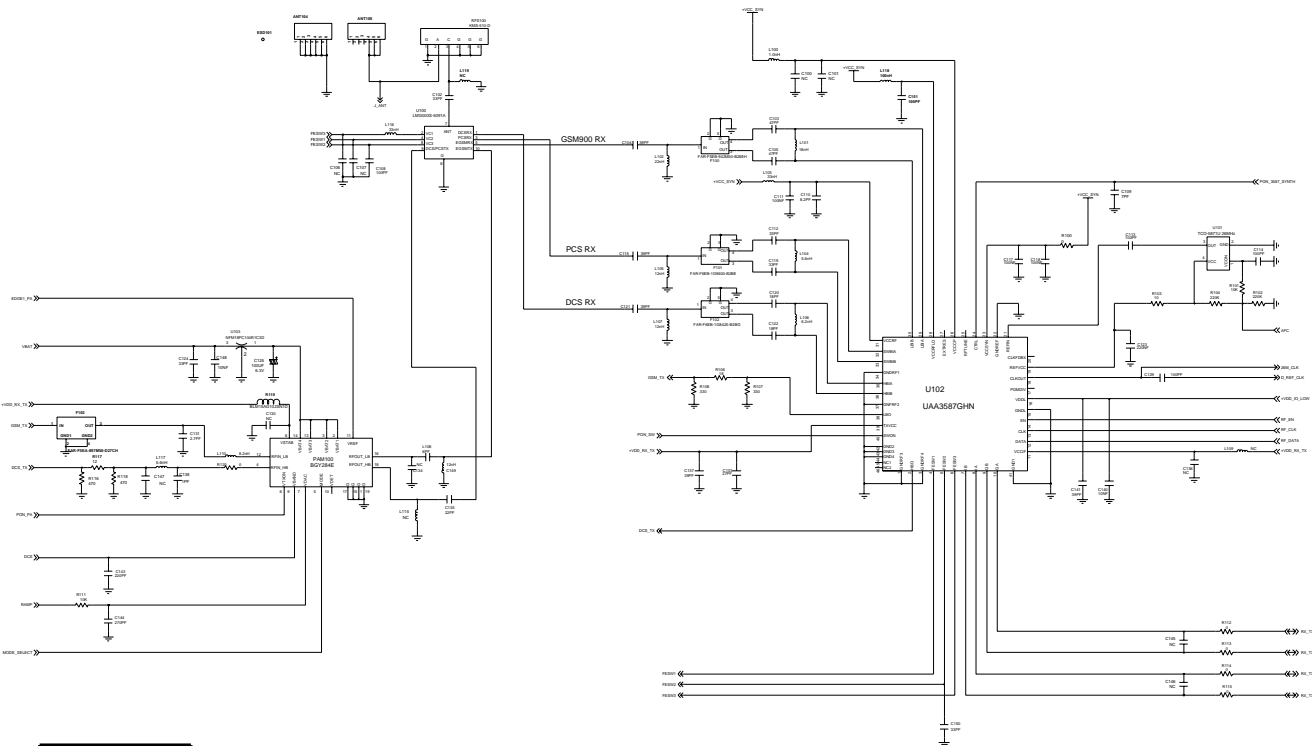

	TEST1	TEST2	TEST3
Tup250000	0H	L	L
TupCC10001000	L	0H	0H
Tup2500000	L	L	L
TupCC1000	L	L	L
TupCC10000	L	L	0H

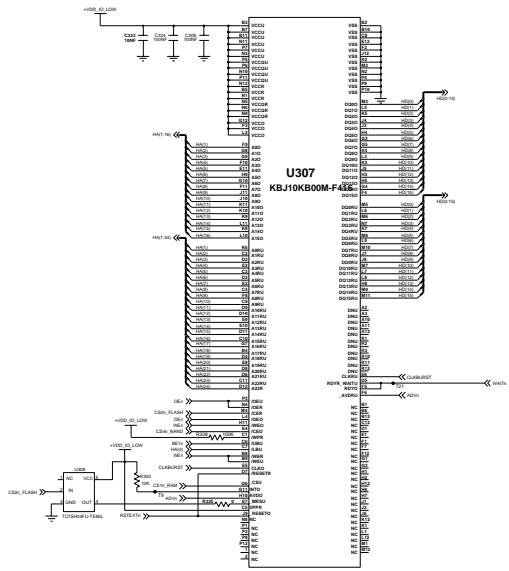

**U307
KB10KB00M-F45C**

MEMORY

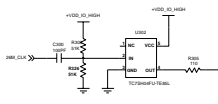

LEVEL SHIFTER

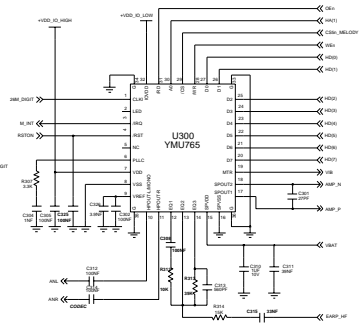

MELODY IC

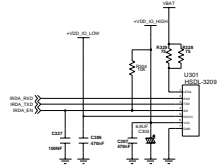

IrDA

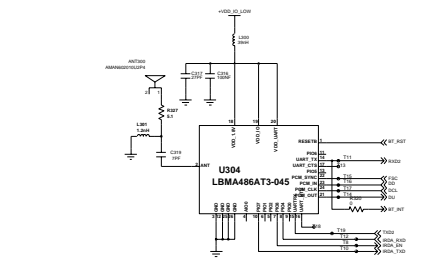

BLUE TOOTH

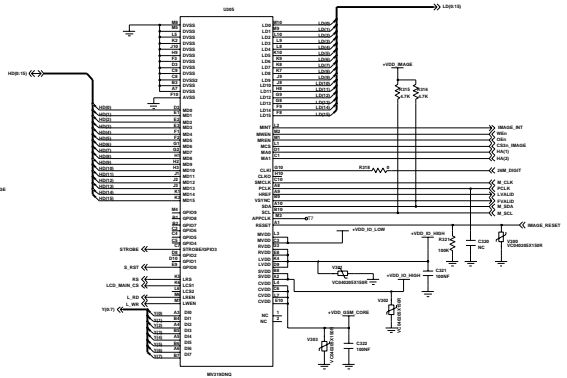
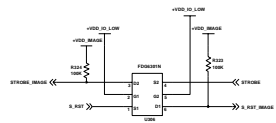

IMAGE_DSP

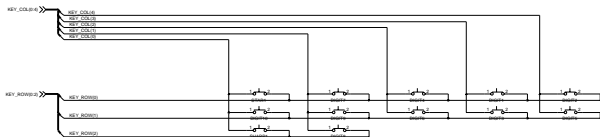

KEY_MAP

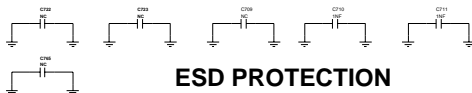

ESD PROTECTION

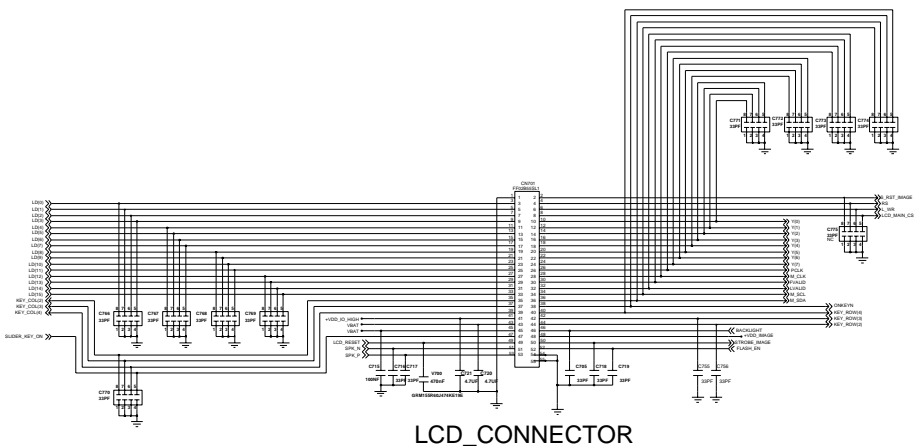
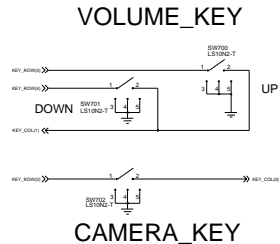

LCD_CONNECTOR

