

Engineer		COMPANY NAME	
Design by	CSH	Address	
Checked by		City	
Released by		TEL	
Approved by		TELEPHONE	
DRG. No.		FAX	
Date		DRG. No.	

SGH-C260

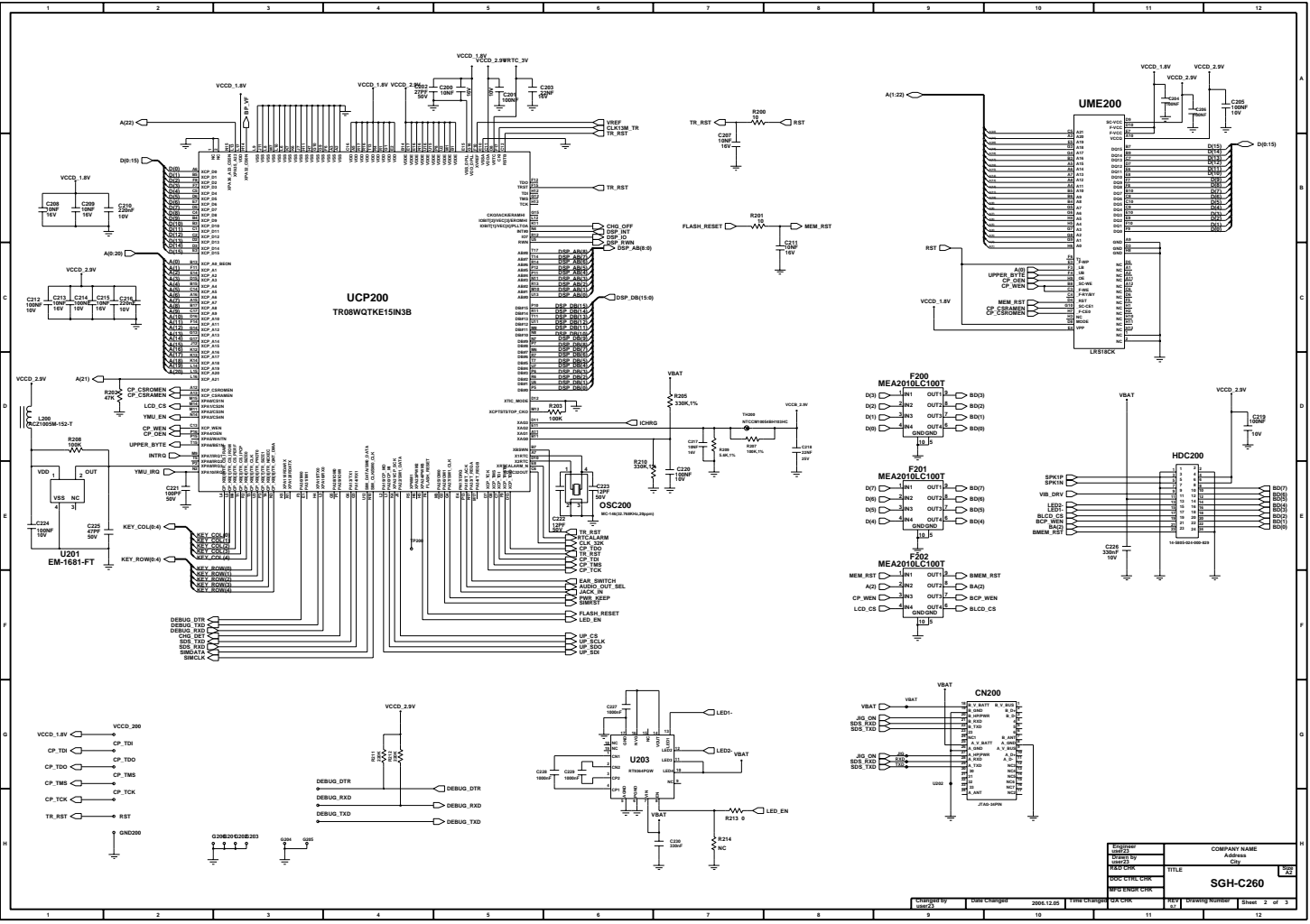

Customer	COMPANY NAME
Design by	Address
Check by	City
DATE CHECK	TITLE
REV ENG/CHK	REV
REV ENG/CHK	DATE
	SGH-C260

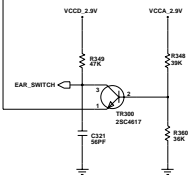
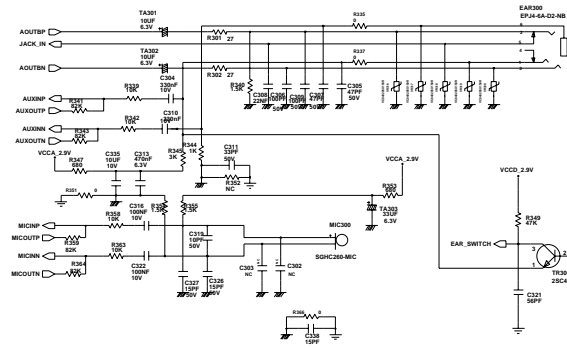
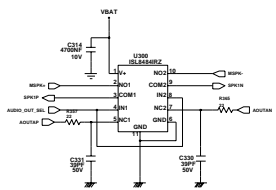
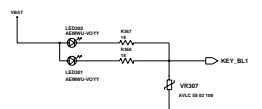
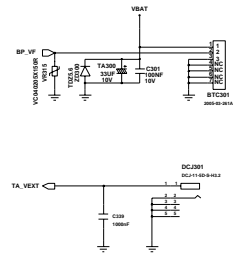
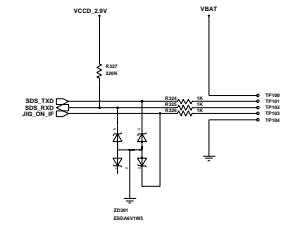
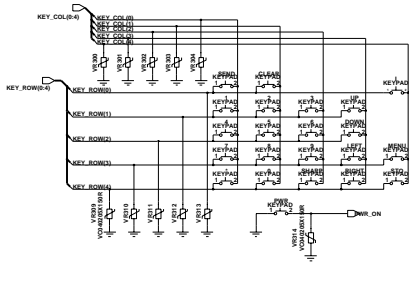

Engineer		COMPANY NAME	
Checked By		Address	
Manufacturer		City	
IPC# & PIN LIST		TITLE	
DATE ENTER FILE		SGH-C260	

U201  
C22 R208  
L200 C225

UP

MENU

LEFT

I

RIGHT

STO

SEND

DOWN

PWR

CLEAR

1

2

3

4

5

6

7

8

9

\*

0

SHARP

LED302

R367

LED301

R307

R368

