

SAMSUNG

GSM TELEPHONE
SGH-C210

SERVICE *Manual*

GSM TELEPHONE



CONTENTS

1. Specification
2. Circuit Description
3. Exploded Views and Parts List
4. Electrical Parts List
5. Block Diagrams
6. PCB Diagrams
7. Flow Chart of Troubleshooting

1. Specification

1-1. GSM General Specification

	EGSM 900 Phase 2	DCS 1800 Phase 1	PCS 1900 Phase 1
Freq. Band[MHz] Uplink/Downlink	880~915 925~960	1710~1785 1805~1880	1850~1910 1930~1960
ARFCN range	0~124 & 975~1023	512~885	512~810
Tx/Rx spacing	45MHz	95MHz	80MHz
Mod. Bit rate/ Bit Period	270.833kbps 3.692us	270.833kbps 3.692us	270.833kbps 3.692us
Time Slot Period/Frame Period	576.9us 4.615ms	576.9us 4.615ms	576.9us 4.615ms
Modulation	0.3GMSK	0.3GMSK	0.3GMSK
MS Power	33dBm~5dBm	30dBm~0dBm	30dBm~0dBm
Power Class	5pcl ~ 19pcl	0pcl ~ 15pcl	0pcl ~ 15pcl
Sensitivity	-102dBm	-100dBm	-100dBm
TDMA Mux	8	8	8
Cell Radius	35Km	2Km	2Km
Operating Temperature	-20°C ~ +50°C		

2. Circuit Description

2-1. SGH-C210 RF Circuit Description

2-1-1. RX PART

— **ASM(F101)** Switching Tx, Rx path for GSM900, DCS1800 and PCS1900 by logic controlling.

— **ASM Control Logic Truth Table**

	VC1	VC2	VC3
EGSM TX	H	L	L
DCS/PCS TX	L	H	L
PCS_RX	L	L	H

— **Saw FILTER**

To convert Electromagnetic Field Wave to Acoustic Wave and then pass the specific frequency band.

- GSM FILTER (F100) For filtering the frequency band between 925 and 960 MHz.
- DCS FILTER (F100) For filtering the frequency band between 1805 and 1880 MHz
- PCS FILTER (F102) For filtering the frequency band between 1930 and 1990 MHz.

— **Crystal (X101)**

To generate the 26MHz reference clock to drive the logic and RF.

After additional process, the reference clock applies to the U801 Rx IQ demodulator and Tx IQ modulator.

The oscillator for RX IQ demodulator and Tx modulator are controlled by serial data to select channel and use fast lock mode for GPRS high class operation.

— **Si4210 (U102)**

The receive section integrates four differential-input low noise amplifiers LNAs supporting the GSM850, EGSM900, DCS1800 and PCS1900 bands. The LNA inputs are matched to the 150 ohm balanced-output SAW filters through external LC matching network.

A quadrature Image-reject mixer downconverts the RF signal to a 200 KHz intermediate frequency(IF). The mixer output is amplified with an analog programmable gain amplifier(PGA) that is controlled with the AGAIN. The quadrature IF ? ? is digitized with high resolution analog-to-digital converts (ADC).

The ADC output is downconverted to baseband with a digital quadrature LO signal. Digital decimation and FIR filters perform digital filtering and remove ADC quantization noise, blockers and reference interferers.

After filtering, the digital output is scaled with a digital PGA, which is controlled with the DGAIN. DACs drive a differential I and Q analog signal onto the BIP, BIN, BQP and BQN pins to interface to standard analog-input baseband ICs.

2-1-2. TX PART

Baseband IQ signal fed into offset PLL, this function is included inside of U801 chip. The transmit section of U801 consist of an I/Q baseband upconverter, an offset phase-locked loop (OPLL) and two 50 ohm output buffers that can drive an external Power Amplifier(PA). Si4210 chip generates modulator signal which power level is about 1.5dBm and fed into Power Amplifier(U900). The PA output power and power ramping are well controlled by Auto Power Control circuit. We use offset PLL below.

Modulation Spectrum	200kHz offset 30 kHz bandwidth	GSM	-35dBc
		DCS	-35dBc
		PCS	-35dBc
	400kHz offset 30 kHz bandwidth	GSM	-66dBc
		DCS	-65dBc
		PCS	-66dBc
	600kHz ~ 1.8MHz offset 30 kHz bandwidth	GSM	-75dBc
		DCS	-68dBc
		PCS	-75dBc

2-2. Baseband Circuit description of SGH-C210

2-2-1. CSP2200B1

— Power Management

Seven low-dropout regulators designed specifically for GSM applications power the terminal and help ensure optimal system performance and long battery life. A programmable LDO provides support for 1.8V, 3.0V SIMs, while a self-resetting, electronically fused switch supplies power to external accessories. Ancillary support functions, such as two LED drivers and two call-alert drivers, aid in reducing both board area and system complexity. A four-wire serial interface unit(SIU) provides access to control and configuration registers. This interface gives a microprocessor full control of the CSP2200B1 and enables system designers to maximize both standby and talk times. Error reporting is provided via an interrupt signal and status register. Supervisory functions, including a reset generator, an input voltage monitor, and a thermal monitor, support reliable system design. These functions work together to ensure proper system behavior during start-up or in the event of a fault condition(low microprocessor voltage, insufficient battery energy, or excessive die temperature).

— Battery Charge Management

A battery charge management block, incorporating an internal PMOS switch, and an 8-bit ADC, provides fast, efficient charging of single-cell Li-Ion battery. Used in conjunction with a current-limited voltage source, this block safely conditions near-dead cells and provides the option of having fast-charge and top-off controlled internally or by the system's microprocessor.

— Backlight LED Driver

The backlight LED driver is a low-side, programmable current source designed to control the brightness of the keyboard illumination. LED1_DRV is controlled via LED1_[0:2] and can be programmed to sink from 15mA to 60mA in 7.5mA steps. LED2_DRV is controlled via LED2_[0:2] and can be programmed to sink from 5mA to 40mA in 5mA steps. Both LED drivers are capable of sinking their maximum output current at a worst-case maximum output voltage of 0.6V. For efficient use, the LEDs is connected between the battery and the LED_DRV output.

— Vibrator Motor Driver

The vibrator motor driver is a independent voltage regulator to drive a small dc motor that silently alerts the user of an incoming call. The driver is a 3.3V constant source while sinking up to 140mA and controlled by enable signal of main chip. For efficient use and safety, the vibrator motor should be connected between the regulator output and the ground.

2-2-2. Connector

— JTAG Connector

Trident has two JTAG ports which are for ARM core and DSP core(DSP16000). So this system has two port connector for these ports. Pins' initials for ARM core are 'CP_' and pins' initials for DSP core are 'DSP_'. CP_TDI and DSP_TDI signal are used for input of data. CP_TDO and DSP_TDO signals are used for the output of the data. CP_TCK and DSP_TCK signals are used for clock because JTAG communication is a synchronous. CP_TMS and DSP_TMS signals are test mode signals. The difference between these is the RESET_INT signal which is for ARM core RESET.

— Keypad connector

This is consisted of key interface pins in the trident, KEY_ROW[0~4] and KEY_COL[0~4]. These signals compose the matrix. Result of matrix informs the key status to key interface in the trident. Some pins are connected to varistor for ESD protection. And power on/off key is seperated from the matrix.

So power on/off signal is connected with CSP2200 to enable CSP2200.

Nine key LED use the +VBATT supply voltage. These are connected to BACKLIGHT signal in the CSP2200.

This signal enables LEDs with current control.

— EMI Filtering

This system uses the EMI Filter to reduce noise from LCD part. Some control signals are connected to LCD without EMI filtering.

2-2-3. IF connector

It is 24-pin connector, and separated into two parts. One is a power supply part for main system. And the other is designed to use SDS, DEBUG, DLC-DETECT, JIG_ON, VEXT, VTEST, VF, and GND. They connected to power supply IC, microprocessor and signal processor IC.

2-2-4. Audio

AOUTAP, AOUTAN from CSP2200 is connected to the speaker via analog switch. AOUTBP and AOUTBN are connected to the ear-mic speaker via ear-jack. MICIN and MICOUT are connected to the main MIC. And AUXIN and AUXOUT are connected to the Ear-mic.

YMU762MA3 is a LSI for portable telephone that is capable of playing high quality music by utilizing FM synthesizer and ADPCM decoder that are included in this device.

As a synthesis, YMU762MA3 is equipped 16 voices with different tones. Since the device is capable of simultaneously generating up to synchronous with the play of the FM synthesizer, various sampled voices can be used as sound effects. Since the play data of YMU762MA3 are interpreted at anytime through FIFO, the length of the data(playing period) is not limited, so the device can flexibly support application such as incoming call melody music distribution service. The hardware sequencer built in this device allows playing of the complex music without giving excessive load to the CPU of the portable telephones. Moreover, the registers of the FM synthesizer can be operated directly for real time sound generation, allowing, for example, utilization of various sound effects when using the game software installed in the portable telephone.

YMU762 includes a speaker amplifier with high ripple removal rate whose maximum output is 550mW (SPVDD=3.6V).

The device is also equipped with conventional function including a vibrator and a circuit for controlling LEDs synchronous with music.

For the headphone, it is provided with a stereophonic output terminal.

For the purpose of enabling YMU762MA3 to demonstrate its full capabilities, Yamaha purpose to use "SMAF:Synthetic music Mobile Application Format" as a data distribution format that is compatible with multimedia.

Since the SMAF takes a structure that sets importance on the synchronization between sound and images, various contents can be written into it including incoming call melody with words that can be used for training karaoke, and commercial channel that combines texts, images and sounds, and others. The hardware sequencer of YMU762MA3 directly interprets and plays blocks relevant to synthesis (playing music and reproducing ADPCM with FM synthesizer) that are included in data distributed in SMAF.

2-2-5. Memory

This system uses SHARP's memory, LRS18B0.

It is consisted of 256M bits flash memory and 64M bits SCRAM. It has 16 bit data line, D[0~15] which is connected to trident, LCD or CSP2200. It has 23 bit address lines, A[1~23]. They are also connected. CP_CSRROMEN signal, chip select signal in the trident, enable flash memories. They use supply voltages, VCCD and VCC_1.8A.

During wrting process, CP_WEN is low and it enables writing process to flash memory and SCRAM. During reading process, CP_OEN is low and it output information which is located at the address from the trident in the flash memory or SCRAM to data lines. Each chip select signals in the trident select flash memory or SCRAM. Reading or writing procedure is processed after CP_WEN or CP_OEN is enabled. Memories use FLASH_RESET, which is buffered signal of RESET from CSP2200, for ESD protection. A[0] signal enables lower byte of SCRAM and UPPER_BYTE signal enables higher byte of SCRAM.

2-2-6. Trident

Trident is consisted of ARM core and DSP core. It has 20K*16bits RAM 144K*16bits ROM in the DSP. It has 4K*32bits ROM and 2K*32bits RAM in the ARM core. DSP is consisted of timer, one bit input/output unit(BIO), JTAG, EMI and HDS(Hardware Development System). ARM core is consisted of EMI, PIC(Programmable Interrupt Controller), reset/power/clock unit, DMA controller, TIC(Test Interface Controller), peripheral bridge, PPI, SSI(Synchronous Serial Interface), ACCs(Asynchronous communications controllers), timer, ADC, RTC(Real-Time Clock) and keyboard interface. DSP_AB[0~8], address lines of DSP core and DSP_DB[0~15], data lines of DSP core are connected to CSP2200. A[0~20], address lines of ARM core and D[0~15], data lines of ARM core are connected to memory, LCD and YMU762.

ICP(Interprocessor Communication Port) controls the communication between ARM core and DSP core.

CSROMEN, CSRAMEN and CS1N to CS4N in the ARM core are connected to each memory. WEN and OEN control the process of memory. External IRQ(Interrupt ReQuest) signals from each units, such as, YMU, Ear-jack, Ear-mic and CSP1093, need the compatible process.

Some PPI pins has many special functions. CP_KB[0~9] receive the status from key FPCB and are used for the communications using data link cable(DEBUG_DTR/RTS/TXD/RXD/CTS/DSR).

And UP_CS/SCLK/SDI, control signals for CSP2200 are outputted through PPI pins. It has signal port for charging(CHG_DET), SIM_RESET and FLIP_SNS with which we knows open.closed status of folder. It has JTAG control pins(TDI/TDO/TCK) for ARM core and DSP core. It recieves 13MHz clock in CKI pin from external TCXO and receives 32.768KHz clock from X1RTC. ADC(Analog to Digital Convertor) part receives the status of temperature, battery type and battery voltage. And control signals(DSP_INT, DSP_IO and DSP_RWN) for DSP core are used. It enables main LCD with DSP IP pins.

2-2-7. CSP2200

CSP2200 is integrated the timing and control functions for GSM 2+ mobile application with the ADC and DAC functions, and power management block. The CSP2200 interfaces to the trident, via a 16-bit parallel interface. It serves as the interface that connects a DSP to the RF circuitry in a GSM 2+ mobile telephone. DSP can load 148 bits of burst data into CSP2200's internal register, and program CSP2200's event timing and control register with the exact time to send the burst. When the timing portion of the event timing and control register matches the internal quarter-bit counter and internal frame counter, the 148 bits in the internal register are GMSK modulated according to GSM 2+ standards. The resulting phase information is translated into I and Q differential output voltages that can be connected directly to an RF modulator at the TXOP and TXON pins. The DSP is notified when the transmission is completed. For receiving baseband data, a DSP can program CSP2200's event timing and control register with the exact time to start receiving I and Q samples through TXIP and TXIN pins. When that time is reached, the control portion of the event timing and control register will start the baseband receive section converting I and Q sample pairs. The samples are stored in a double-buffered register until the register contains 32 sample pairs. CSP2200 then notifies the DSP which has sample time to read the information out before the next 32 sample pairs are stored. The voice band ADC converter issues an interrupt to the DSP whenever it finishes converting a 16-bit PCM word. The DSP then reads the new input sample and simultaneously loads the voice band output DAC converter with a new PCM output word. The voice band output can be connected directly to a speaker via AOUTAN and AOUTAP pins and be connected to a Ear-mic speaker via AOUTBN and AOUTBP pins.

There are 7 LDOs which are power sources of microprocessor, LCD, etc. These 7 LDOs output are programmable.

3. Exploded View and Parts List

3-1. Exploded View

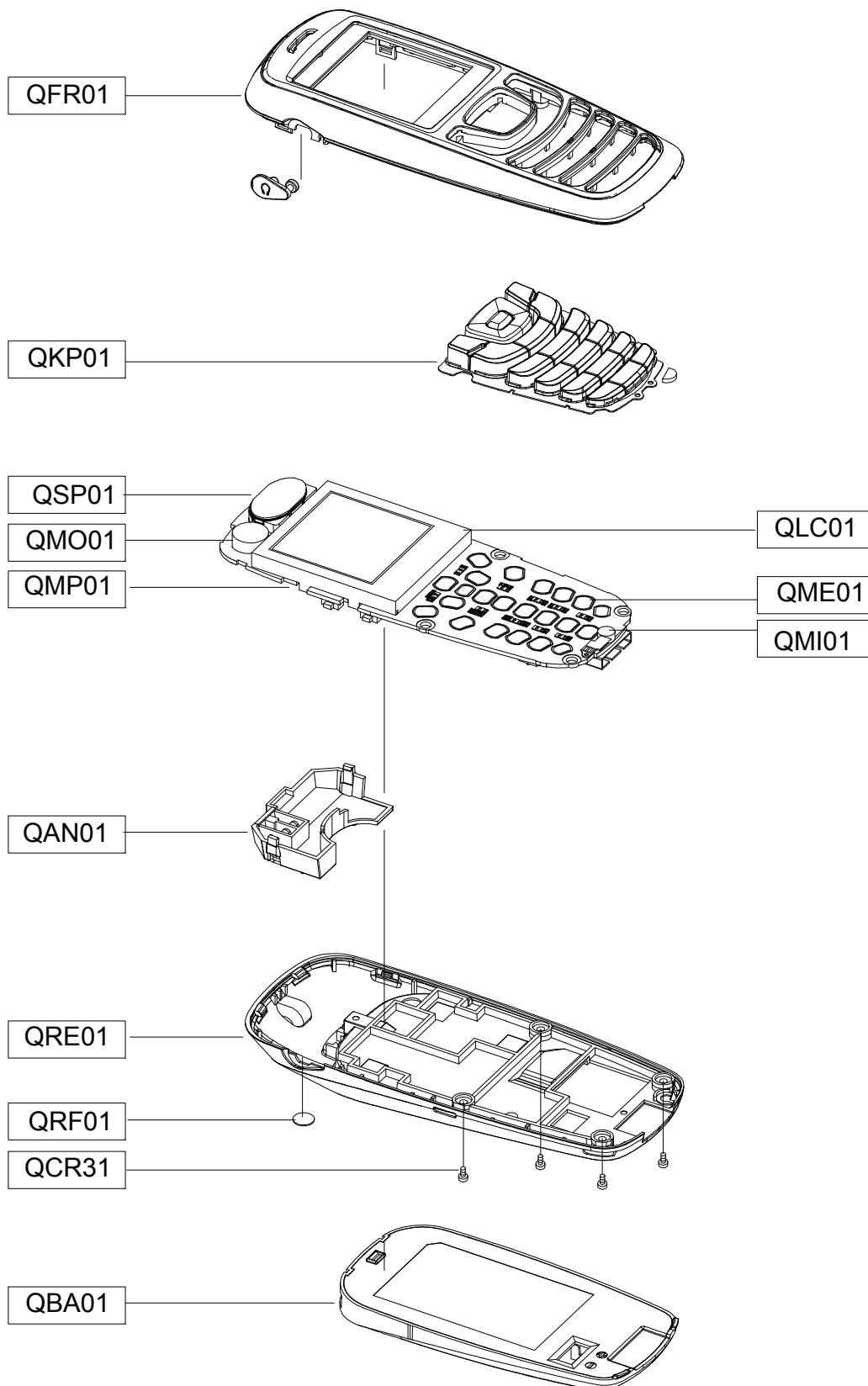

3-2. Parts List

Location NO.		Description	SEC CODE	Remark
QFR01		FRONT COVER	GH75-06802A	
QKP01		KEYPAD	GH75-06998A	
QSP01		SPEAKER	3001-001760	
QMO01		MOTOR DC	GH31-00163A	
QMP01		PBA MAIN	GH92-02142A	
QLC01		LCD	GH07-00701A	
QME01		UNIT METAL DOME	GH59-02090A	
QMI01		MICROPHONE ASSY	GH30-00186A	
QAN01		INTENNA	GH42-00552A	
QRE01		REAR COVER	GH75-06804A	
QRF01		TAPE PC RF	GH74-14175A	
QCR31		SCREW	6001-001795	
QBA01		BATTERY	GH43-01817A	

Description	SEC CODE
BAG PE;LDPE,T0.05,W80,L180,TRP,-,-	6902-000634
ADAPTOR - TAD;TAD137ESE,SGH-P100,-,110	GH44-00482A
LABEL(P) - WATER SOAK;SCH-X110,NORGE,1	GH68-02026A
MANUAL - SFC;SGH-S200,SAMSUNG,RUSSIAN,	GH68-04336A
LABEL(R) - MAIN(SER);SGH-C210,SER,POL	GH68-06983B
MANUAL - USE;SGH-C210,SER,RUSSIAN,ROMA	GH68-07137A
CUSHION - CASE(1 - 2);SGH-C210,PULP,T0.8	GH69-02937A
MPR - ESD TAPE;SGH-C200,3M 851,7X5,-,-	GH74-08853A
MPR - BOHO VINYL M/WIN;SGH-C200,STA EL	GH74-09824B
MPR - MAIN WINDOW BOHO;SGH-C200,ST 555	GH74-11636A

3-3. Test Jig (GH80-00865A)



3-3-1. RF Test Cable
(GH39-00283A)



3-3-2. Test Cable
(GH39-00127A)



3-3-3. Serial Cable



3-3-4. Power Supply Cable



3-3-5. DATA CABLE
(GH39-00143B)



3-3-6. TA
(GH44-00184A)



4. Electrical Parts List

SEC Code	Design LOC	Description
0403-001387	ZD700	DIODE-ZENER
0403-001427	ZD703	DIODE-ZENER
0406-001083	ZD701 ,ZD702	DIODE-TVS
0406-001190	ZD401	DIODE-TVS
0406-001194	ZD601	DIODE-TVS
0406-001201	ZD501 ,ZD502	DIODE-TVS
0407-001002	D501	DIODE-ARRAY
0501-000225	Q400	TR-SMALL SIGNAL
0504-000168	Q300	TR-DIGITAL
0601-002020	LED601 ,LED602 ,LED603	LED
0601-002020	LED604 ,LED605 ,LED606	LED
0601-002020	LED607 ,LED608 ,LED609	LED
0601-002020	LED610	LED
0801-000796	U701	IC
1001-001294	U502	IC
1108-000010	U601	IC
1201-002260	U101	IC
1203-002782	U505	IC
1203-003109	U301	IC
1203-003304	U300	IC
1203-003674	U705	IC
1204-002161	U501	IC
1205-002683	U102	IC
1404-001221	TH200	THERMISTOR
1405-001082	V405 ,V410 ,V411 ,V601	VARISTOR
1405-001082	V602 ,V603 ,V604 ,V605	VARISTOR
1405-001082	V606 ,V607 ,V608 ,V609	VARISTOR
1405-001082	V610 ,V611 ,V613 ,V702	VARISTOR
1405-001082	V703 ,V704 ,V705 ,V706	VARISTOR
1405-001093	V701	VARISTOR
1405-001108	V501 ,V502 ,V503 ,V504	VARISTOR
1405-001108	V612	VARISTOR
2007-000140	R207 ,R417 ,R420 ,R704	R-CHIP
2007-000140	R712 ,R713 ,R714 ,R715	R-CHIP
2007-000140	R716 ,R717 ,R718 ,R719	R-CHIP
2007-000140	R720 ,R721 ,R724 ,R726	R-CHIP
2007-000140	R727	R-CHIP
2007-000142	R406	R-CHIP
2007-000145	R422	R-CHIP

Electrical Parts List

SEC Code	Design LOC	Description
2007-000146	R502	R-CHIP
2007-000148	R112, R402	R-CHIP
2007-000153	R722	R-CHIP
2007-000157	R201, R204, R223, R309	R-CHIP
2007-000162	R208, R211, R501, R725	R-CHIP
2007-000167	R306	R-CHIP
2007-000171	C131, R101, R104, R105	R-CHIP
2007-000171	R107, R213, R214, R216	R-CHIP
2007-000171	R217, R219, R220, R301	R-CHIP
2007-000171	R305, R408, R409, R414	R-CHIP
2007-000171	R418, R419, R500, R612	R-CHIP
2007-000171	R700, R701, R702, R703	R-CHIP
2007-000171	R723	R-CHIP
2007-000172	R222, R304, R611	R-CHIP
2007-000173	R412, R415	R-CHIP
2007-000174	R601, R602, R603, R604	R-CHIP
2007-000174	R605, R606, R607, R608	R-CHIP
2007-000174	R609, R610	R-CHIP
2007-000566	R707, R708, R709, R710	R-CHIP
2007-000566	R711	R-CHIP
2007-001298	R103	R-CHIP
2007-001308	R113	R-CHIP
2007-001313	R102	R-CHIP
2007-001317	R407	R-CHIP
2007-001319	R303, R504	R-CHIP
2007-001320	R405, R411	R-CHIP
2007-001325	R506	R-CHIP
2007-001333	R421	R-CHIP
2007-002797	R108	R-CHIP
2007-003001	R705	R-CHIP
2007-003112	R503, R505	R-CHIP
2007-007134	R410, R416	R-CHIP
2007-007142	R206, R310, R401, R403	R-CHIP
2007-007142	R413	R-CHIP
2007-007308	R210, R212	R-CHIP
2007-007480	R205	R-CHIP
2007-007489	R400, R404	R-CHIP
2007-007538	R218	R-CHIP
2007-008263	R311	R-CHIP

SEC Code	Design LOC	Description
2203-000233	C118,C310,C325,C411	C-CERAMIC,CHIP
2203-000233	C601,C603,C701	C-CERAMIC,CHIP
2203-000254	C134,C201,C202,C203	C-CERAMIC,CHIP
2203-000254	C204,C208,C210,C211	C-CERAMIC,CHIP
2203-000254	C212,C213,C215,C301	C-CERAMIC,CHIP
2203-000254	C319,C605	C-CERAMIC,CHIP
2203-000278	C119,C120	C-CERAMIC,CHIP
2203-000330	C220,C221	C-CERAMIC,CHIP
2203-000386	C127	C-CERAMIC,CHIP
2203-000425	C406	C-CERAMIC,CHIP
2203-000438	C104,C115,C132,C514	C-CERAMIC,CHIP
2203-000438	C700	C-CERAMIC,CHIP
2203-000530	C113	C-CERAMIC,CHIP
2203-000585	C510	C-CERAMIC,CHIP
2203-000628	C405	C-CERAMIC,CHIP
2203-000679	C207,C419	C-CERAMIC,CHIP
2203-000696	C124,C142	C-CERAMIC,CHIP
2203-000812	C305,C306,C307,C401	C-CERAMIC,CHIP
2203-000812	C402,C409,C416	C-CERAMIC,CHIP
2203-000854	C117,C706	C-CERAMIC,CHIP
2203-000995	C105,C116,C404	C-CERAMIC,CHIP
2203-001017	C141	C-CERAMIC,CHIP
2203-001072	C302,C417,C418	C-CERAMIC,CHIP
2203-001405	C209	C-CERAMIC,CHIP
2203-001412	C129	C-CERAMIC,CHIP
2203-001432	C114	C-CERAMIC,CHIP
2203-001598	C309,C318	C-CERAMIC,CHIP
2203-002668	C107,C111	C-CERAMIC,CHIP
2203-002677	C138,C140	C-CERAMIC,CHIP
2203-002687	C504	C-CERAMIC,CHIP
2203-005061	C206,C308,C320,C501	C-CERAMIC,CHIP
2203-005061	C506,C509,C511,C515	C-CERAMIC,CHIP
2203-005061	C602,C604	C-CERAMIC,CHIP
2203-005065	C321,C500	C-CERAMIC,CHIP
2203-005234	C121,C122	C-CERAMIC,CHIP
2203-005393	C103	C-CERAMIC,CHIP
2203-005450	C139	C-CERAMIC,CHIP
2203-005482	C137,C143,C144,C303	C-CERAMIC,CHIP
2203-005496	C205,C214,C403,C407	C-CERAMIC,CHIP

Electrical Parts List

SEC Code	Design LOC	Description
2203-005496	C413, C507	C-CERAMIC, CHIP
2203-006053	C312, C313, C314, C315	C-CERAMIC, CHIP
2203-006053	C316	C-CERAMIC, CHIP
2203-006090	C110	C-CERAMIC, CHIP
2203-006093	C304, C503	C-CERAMIC, CHIP
2203-006190	C513	C-CERAMIC, CHIP
2203-006208	C512	C-CERAMIC, CHIP
2203-006257	C327	C-CERAMIC, CHIP
2203-006348	C703	C-CERAMIC, CHIP
2203-006438	C218	C-CERAMIC, CHIP
2203-006562	C704	C-CERAMIC, CHIP
2404-001105	C412, C414, C502	C-TA, CHIP
2404-001134	C109	C-TA, CHIP
2404-001240	C311	C-TA, CHIP
2404-001268	C324, C326, C505, C705	C-TA, CHIP
2404-001305	C410	C-TA, CHIP
2503-001041	C708, C709	C-NETWORK
2503-001053	C710, C711, C712, C713	C-NETWORK
2503-001053	C714	C-NETWORK
2703-002170	L108	INDUCTOR-SMD
2703-002198	L102	INDUCTOR-SMD
2703-002199	L106	INDUCTOR-SMD
2703-002202	L401, L402	INDUCTOR-SMD
2703-002203	L109	INDUCTOR-SMD
2703-002205	L103, L112	INDUCTOR-SMD
2703-002269	L113	INDUCTOR-SMD
2703-002339	L701	INDUCTOR-SMD
2703-002367	L101	INDUCTOR-SMD
2703-002544	L105, L111	INDUCTOR-SMD
2703-002558	L107	INDUCTOR-SMD
2801-003856	X201	CRYSTAL-UNIT
2801-004426	X101	CRYSTAL-UNIT
2904-001480	F102	FILTER-SAW
2904-001523	F100	FILTER-SAW
3301-001659	L702	CORE-FERRITE BEAD
3705-001347	CN100	CONNECTOR-COAXIAL
3709-001336	CN300	CONNECTOR-CARD EDGE
3710-001611	CN701	CONNECTOR-SOCKET
3711-005829	CN702	CONNECTOR-HEADER

SEC Code	Design LOC	Description
3722-002067	CN401	JACK-PHONE
4302-001130	U303	BATTERY
NEW-1C001	F101	COMP-SMD

5. Block Diagrams

5-1. RF Solution Block Diagram

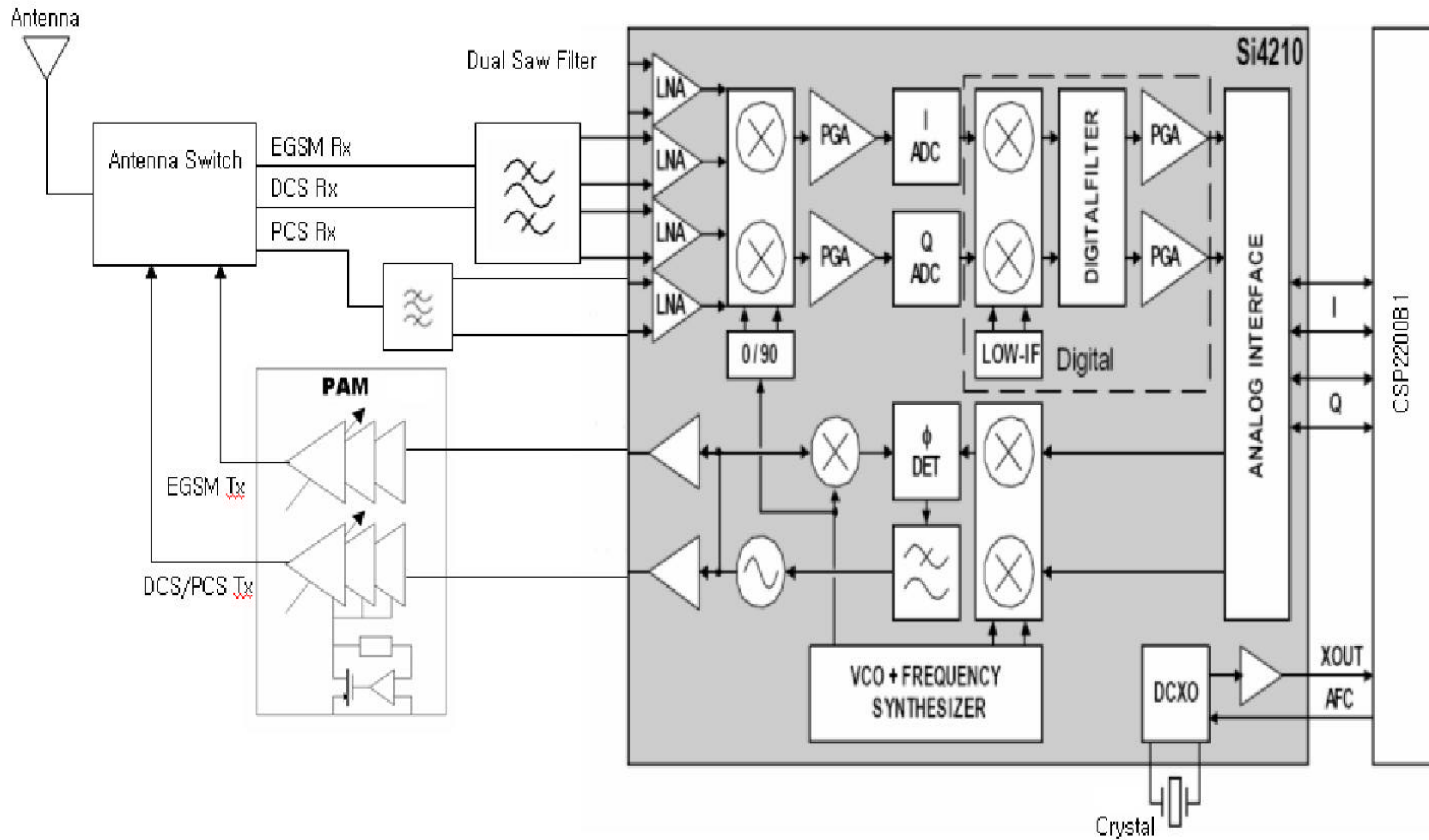

5-2. Base Band Solution Block Diagram

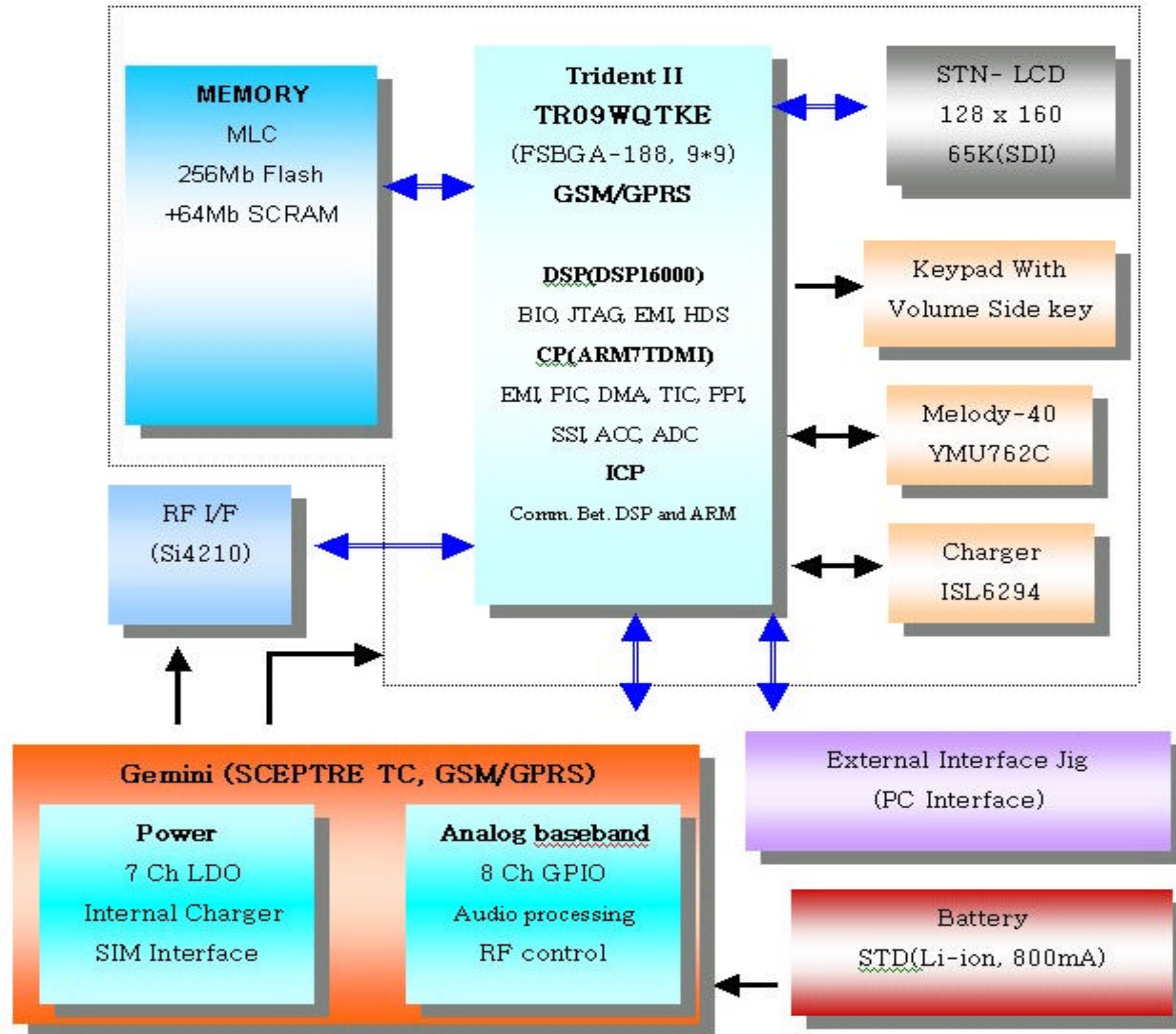

6. PCB Diagrams

6-1. Main PCB Top Diagram

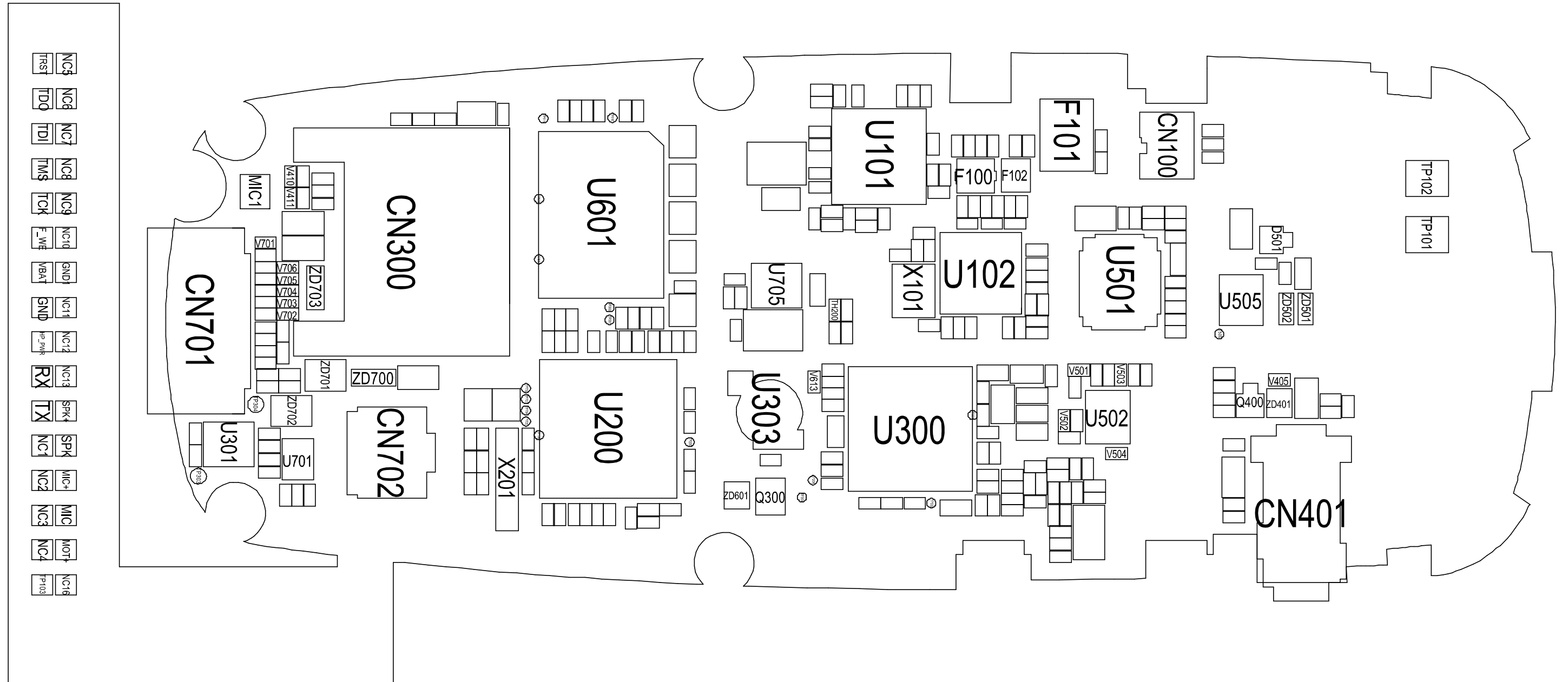

6-2. Main PCB Bottom Diagram

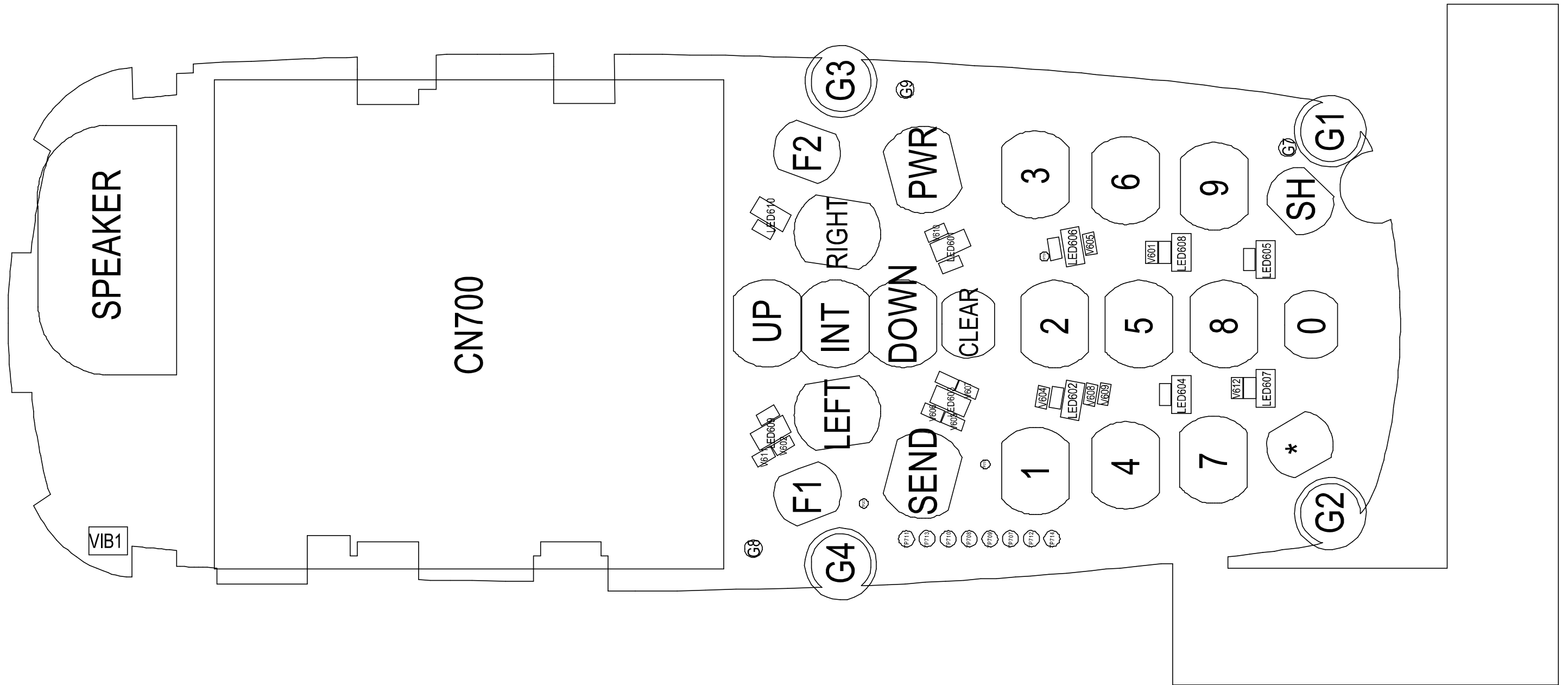

7. Flow Chart of Troubleshooting

7-1. Power On

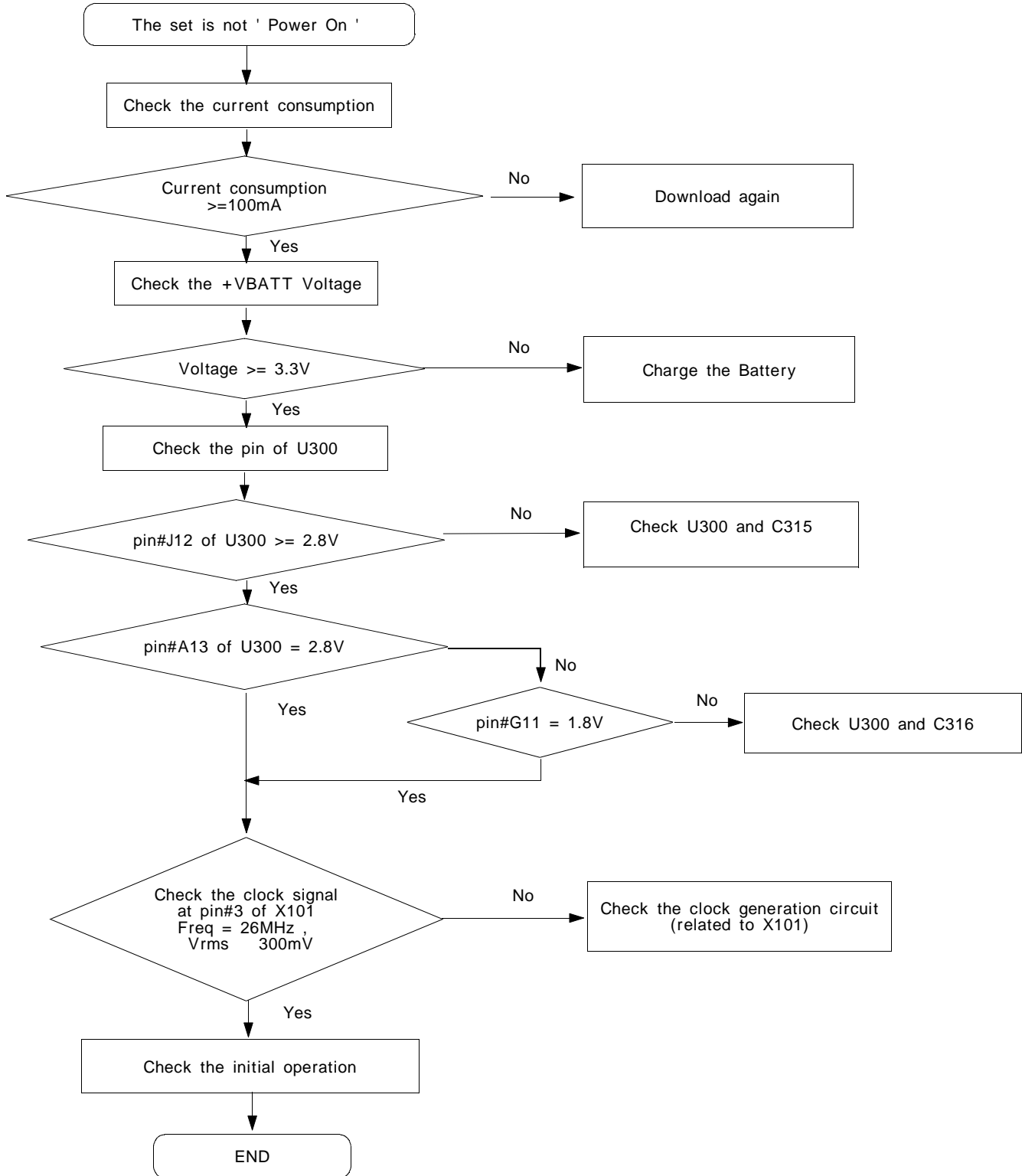

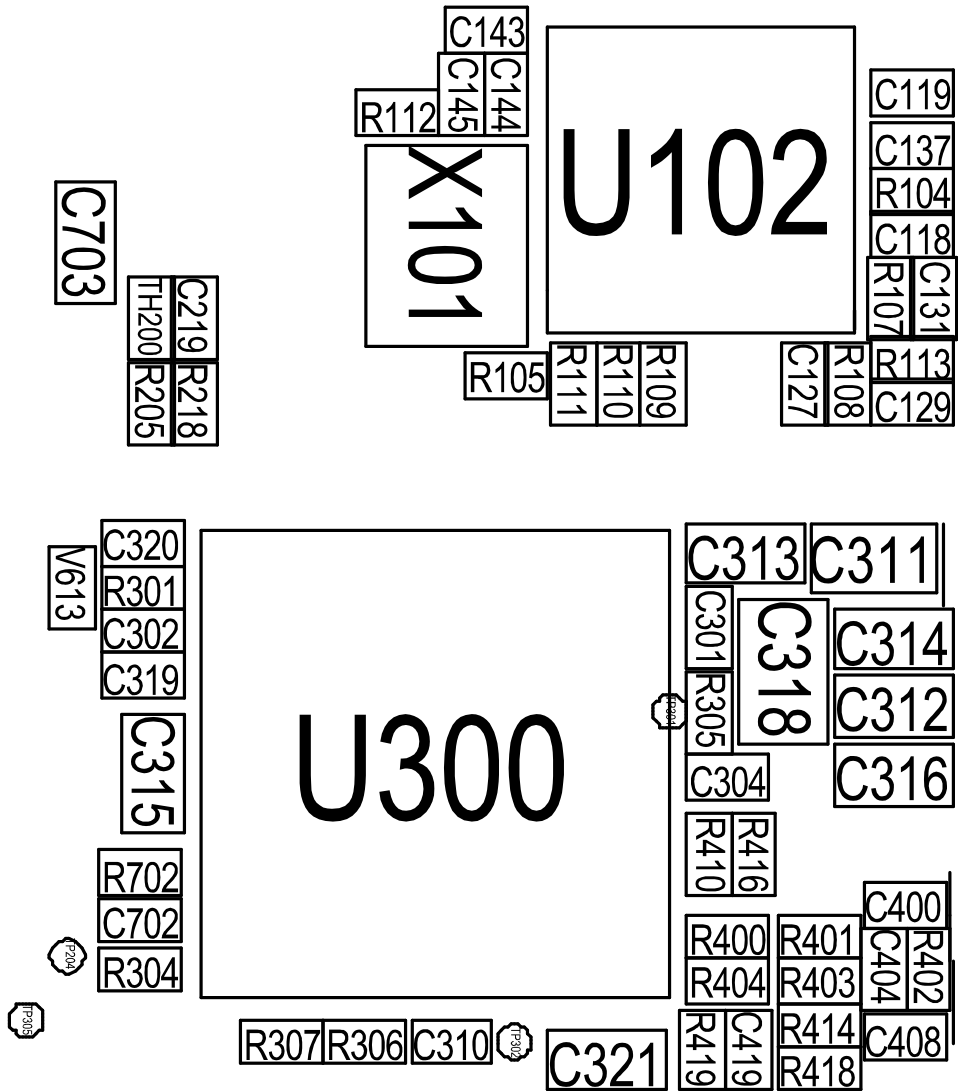

7-2. Initial

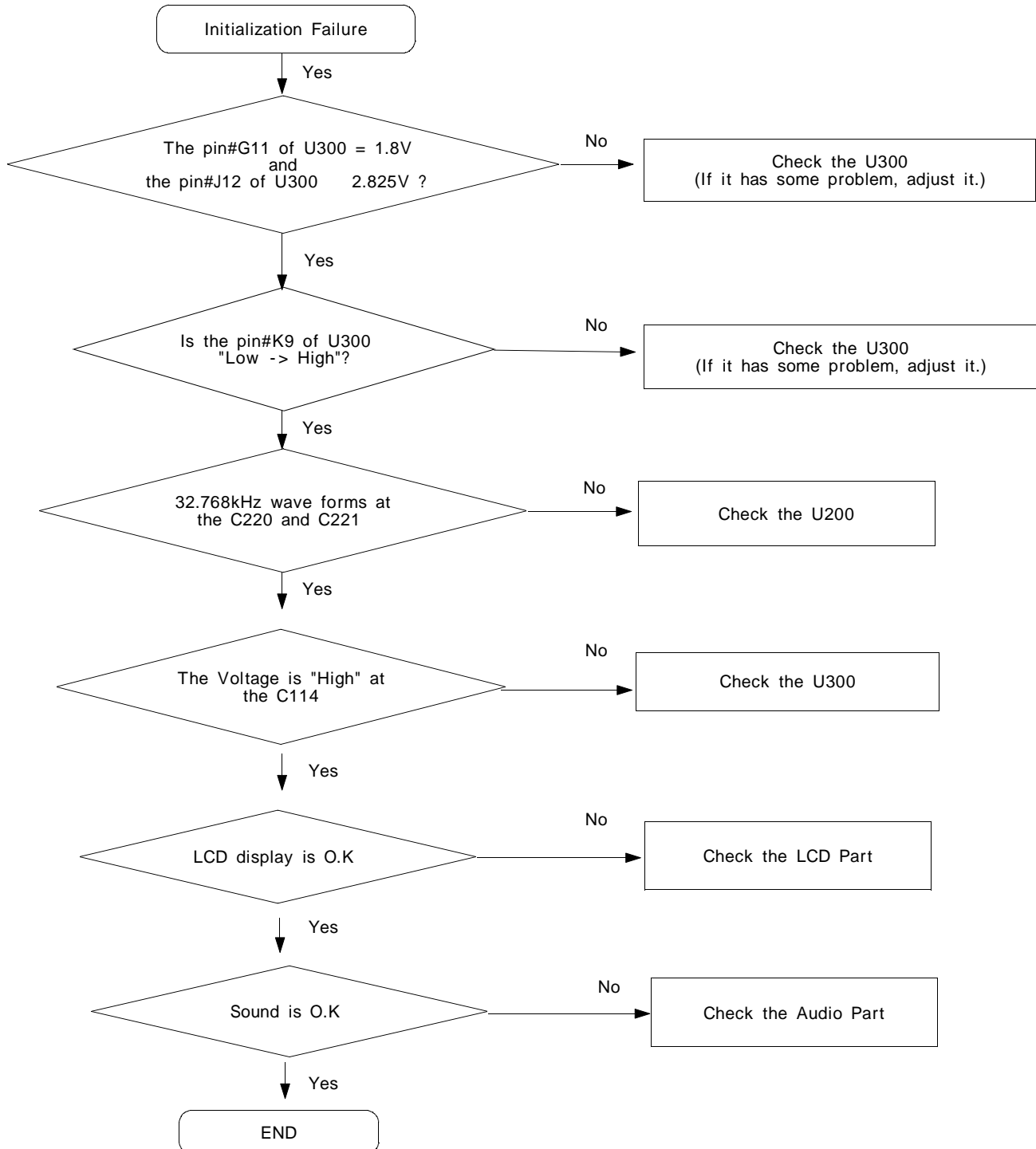

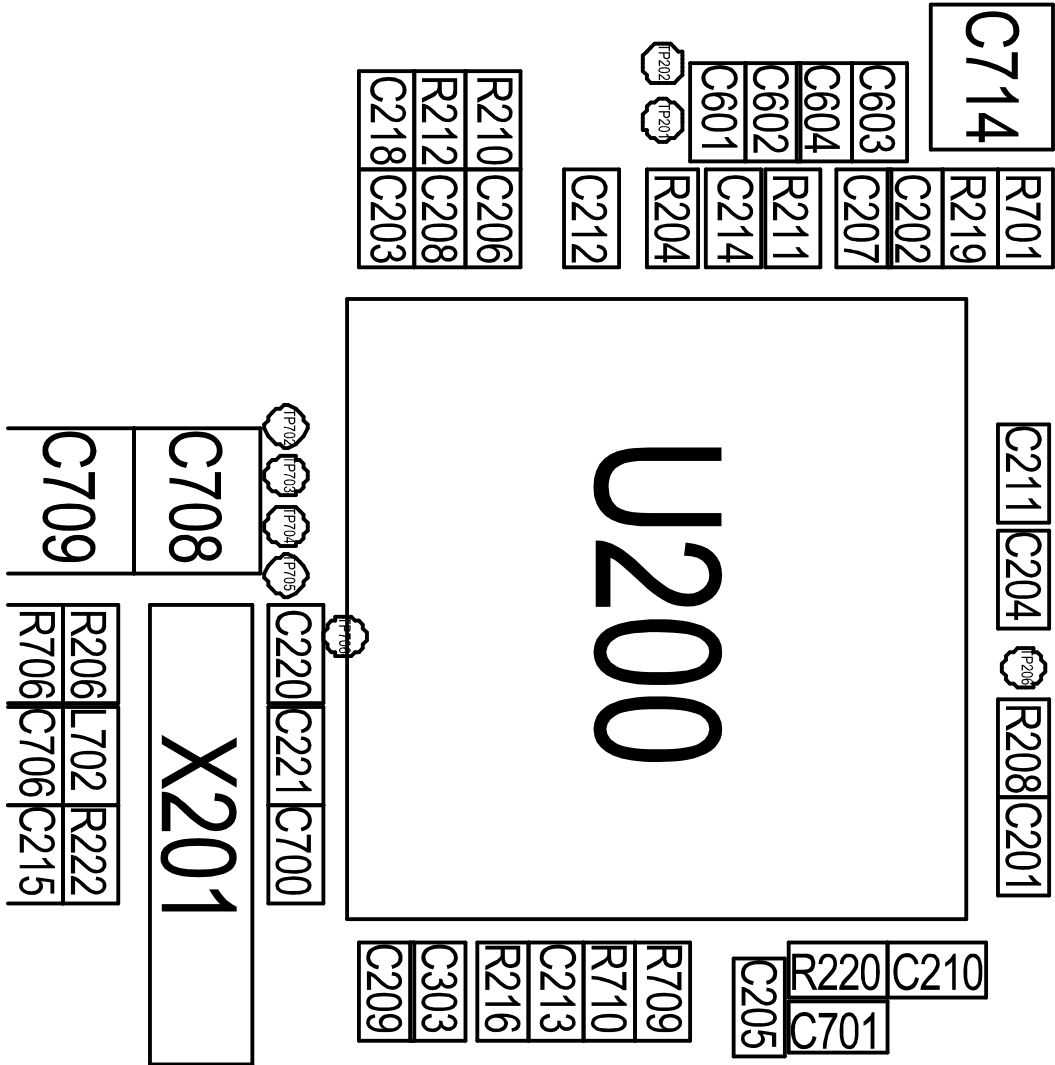

7-3. SIM Part

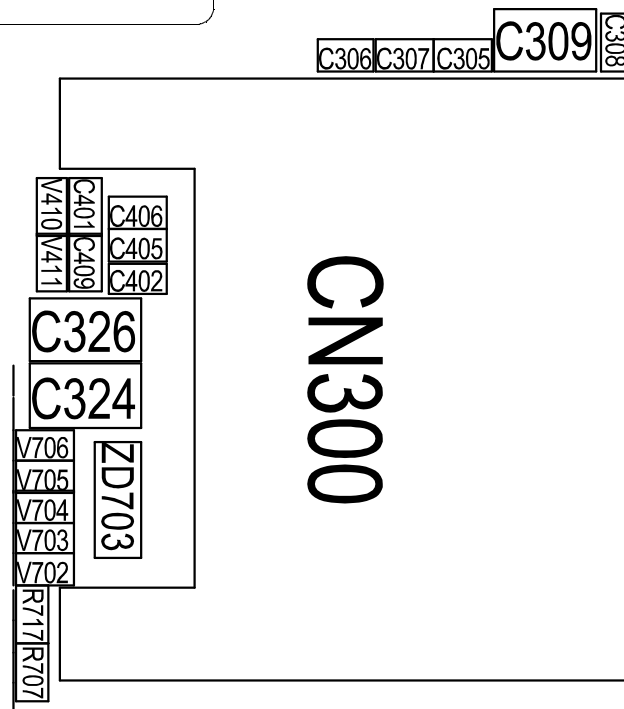
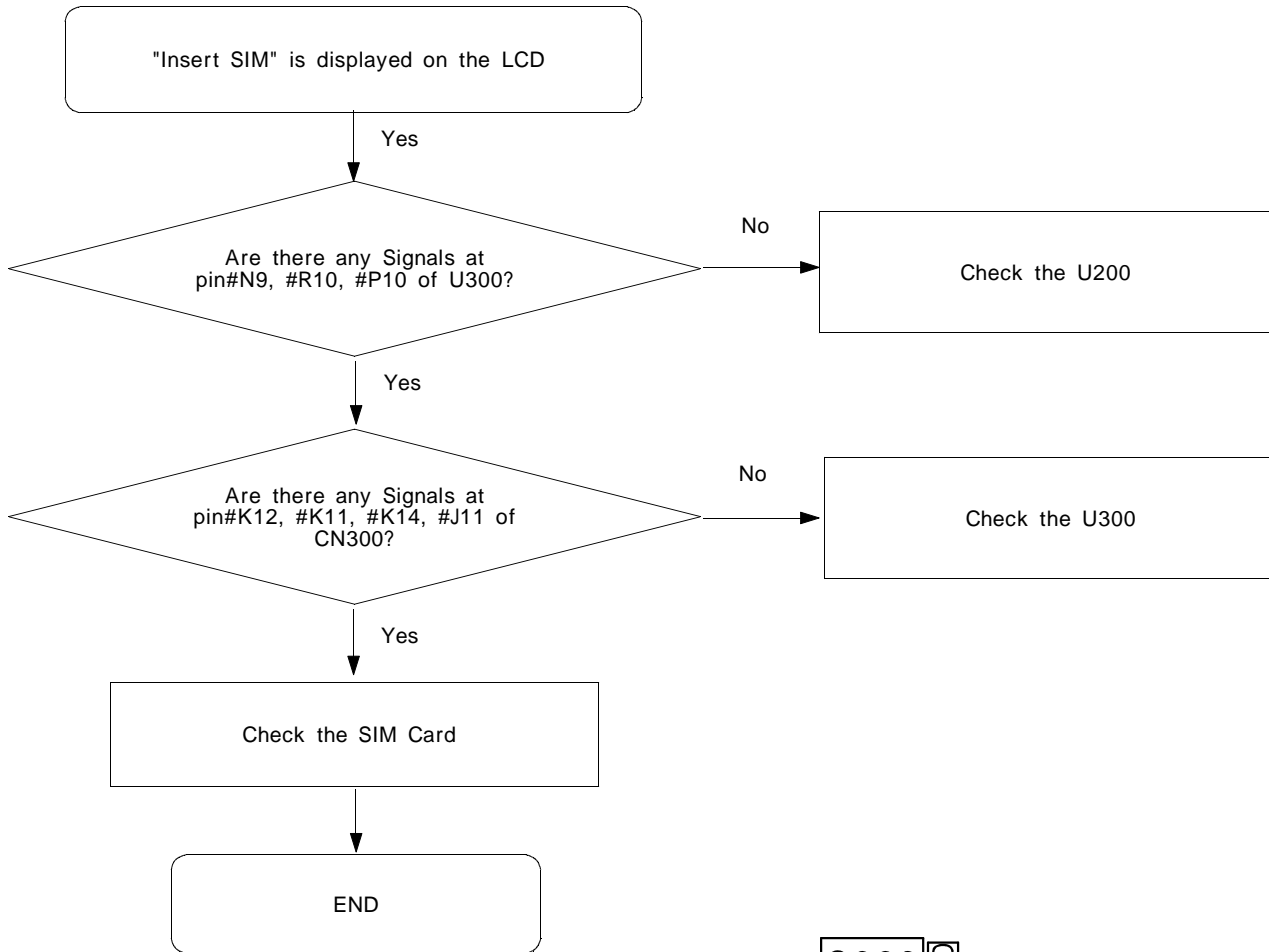

7-4. Charging Part

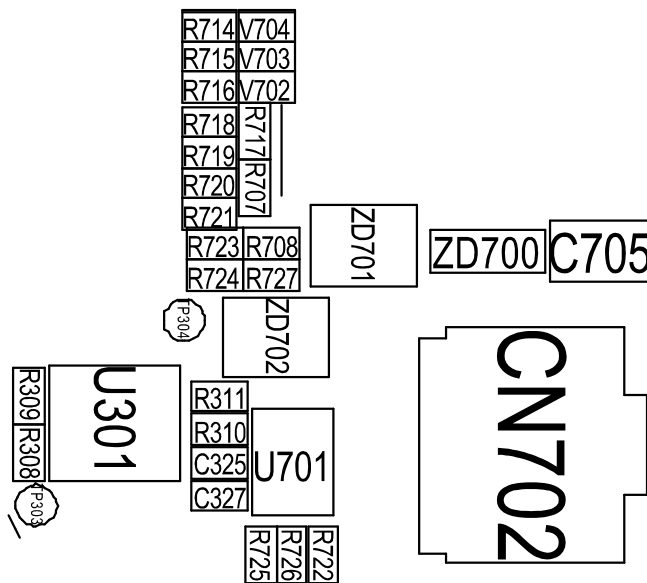
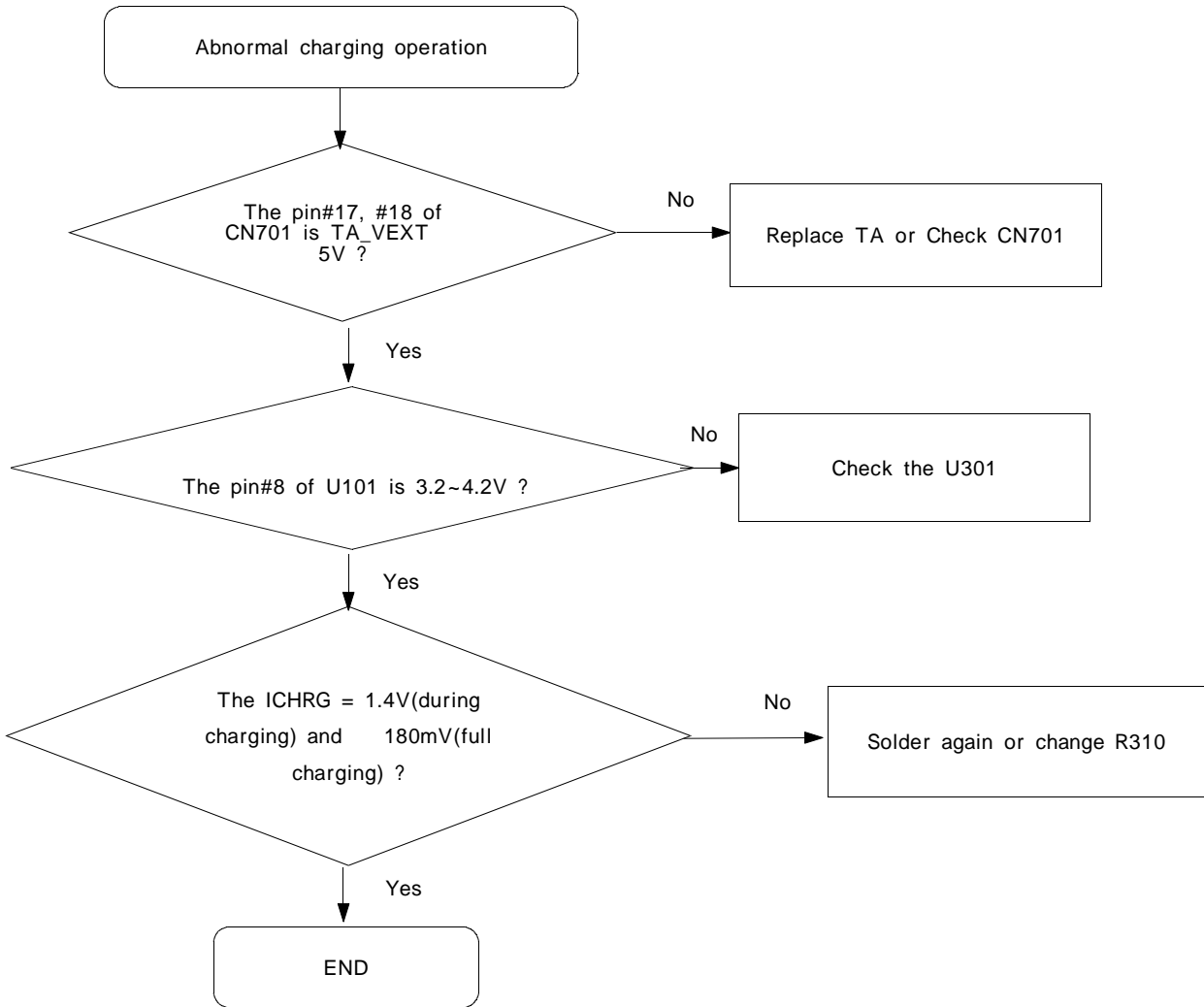

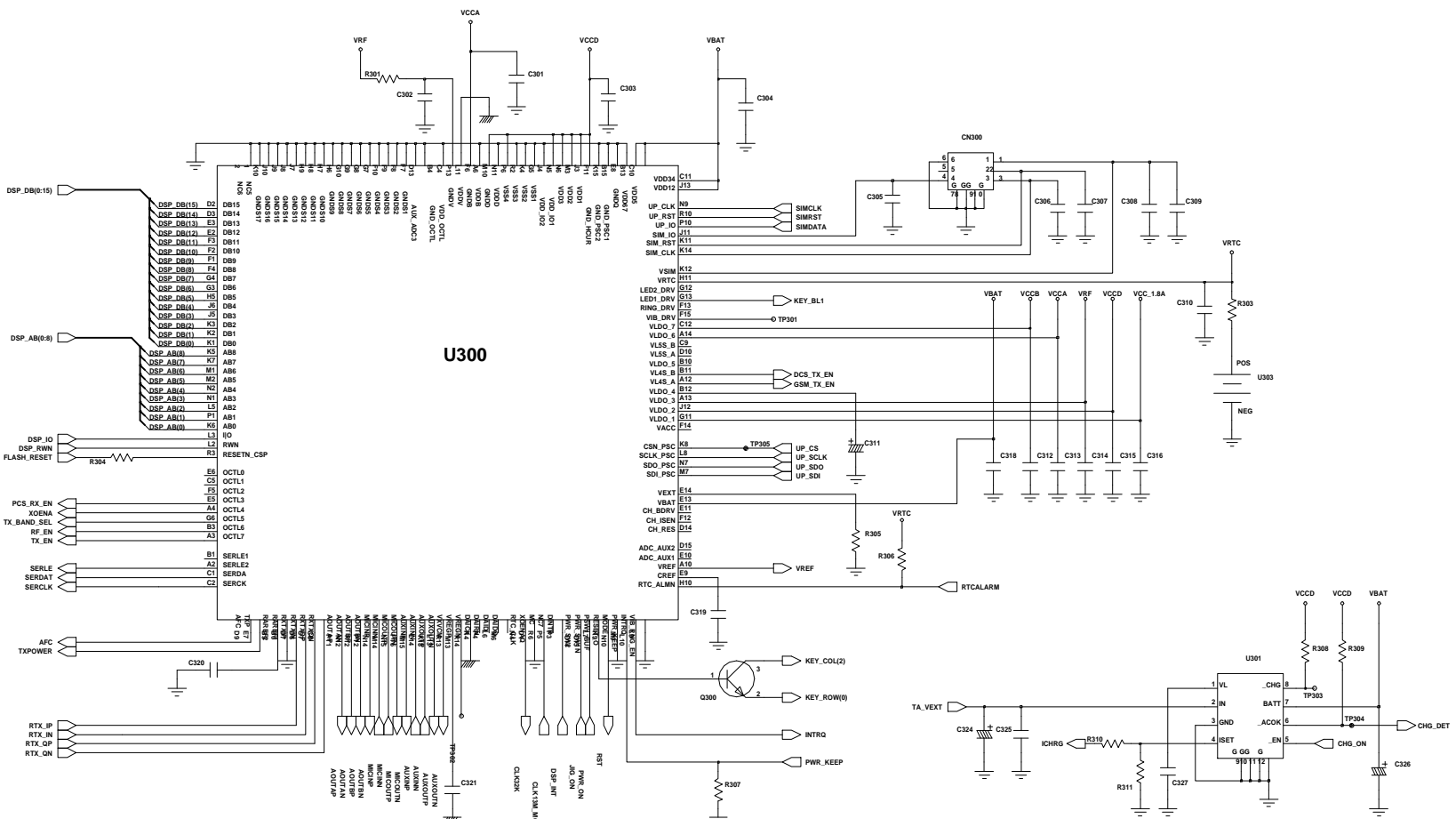

7-5. Microphone Part

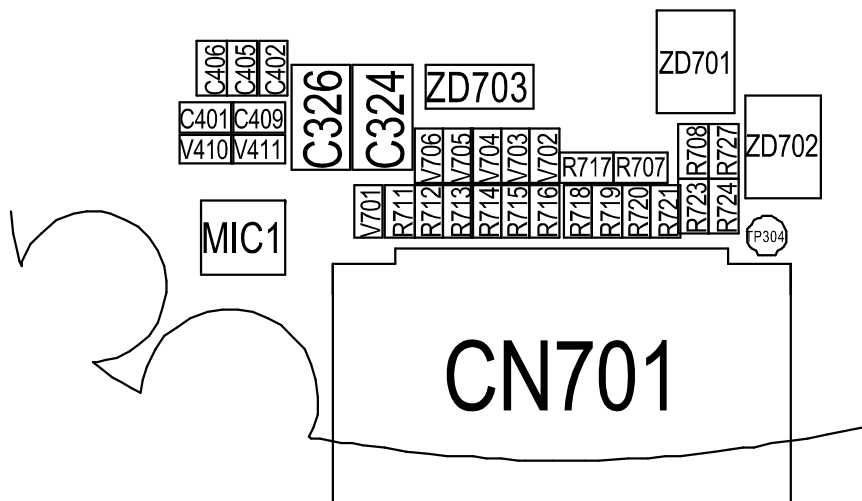
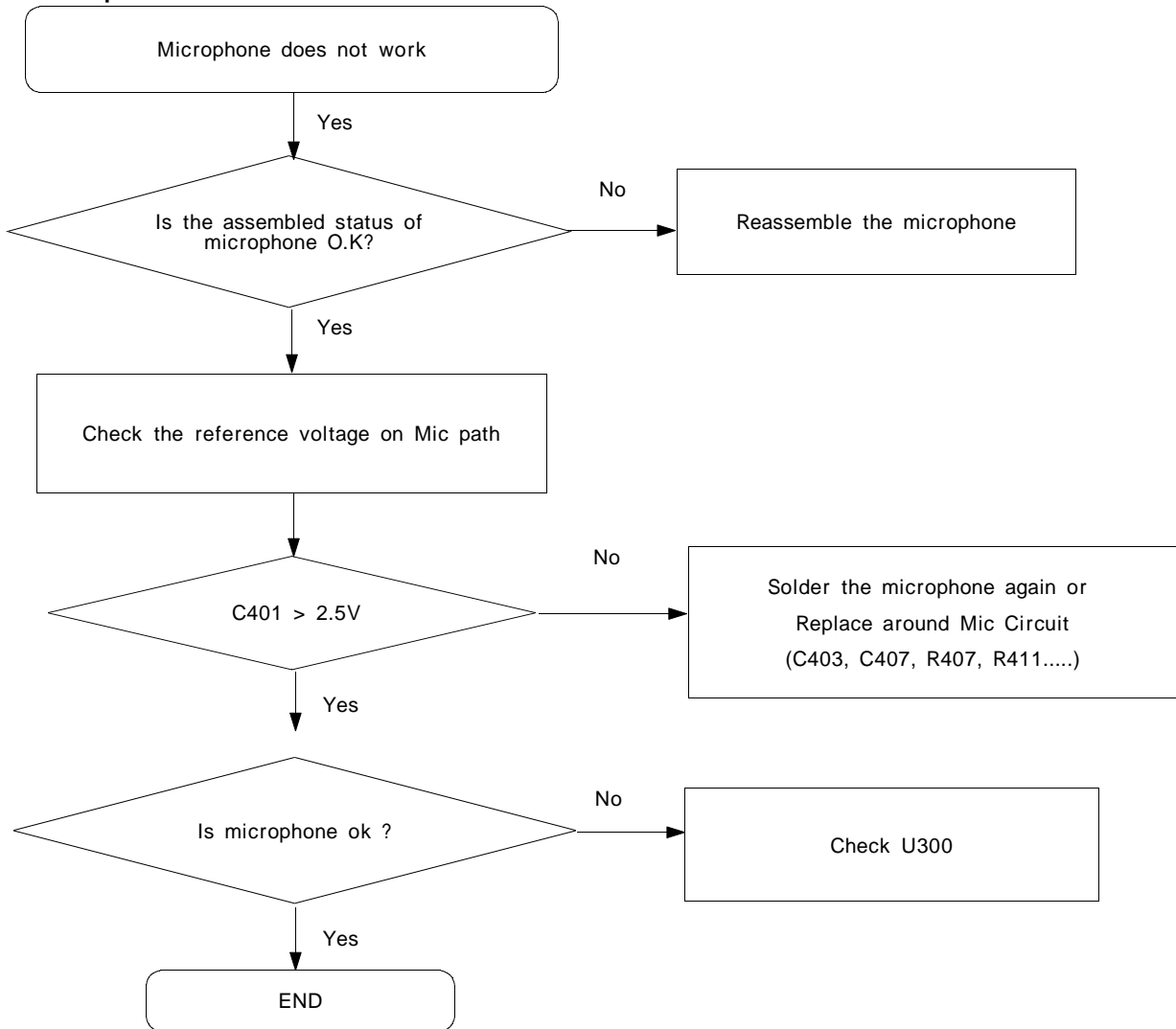

7-6. Speaker Part

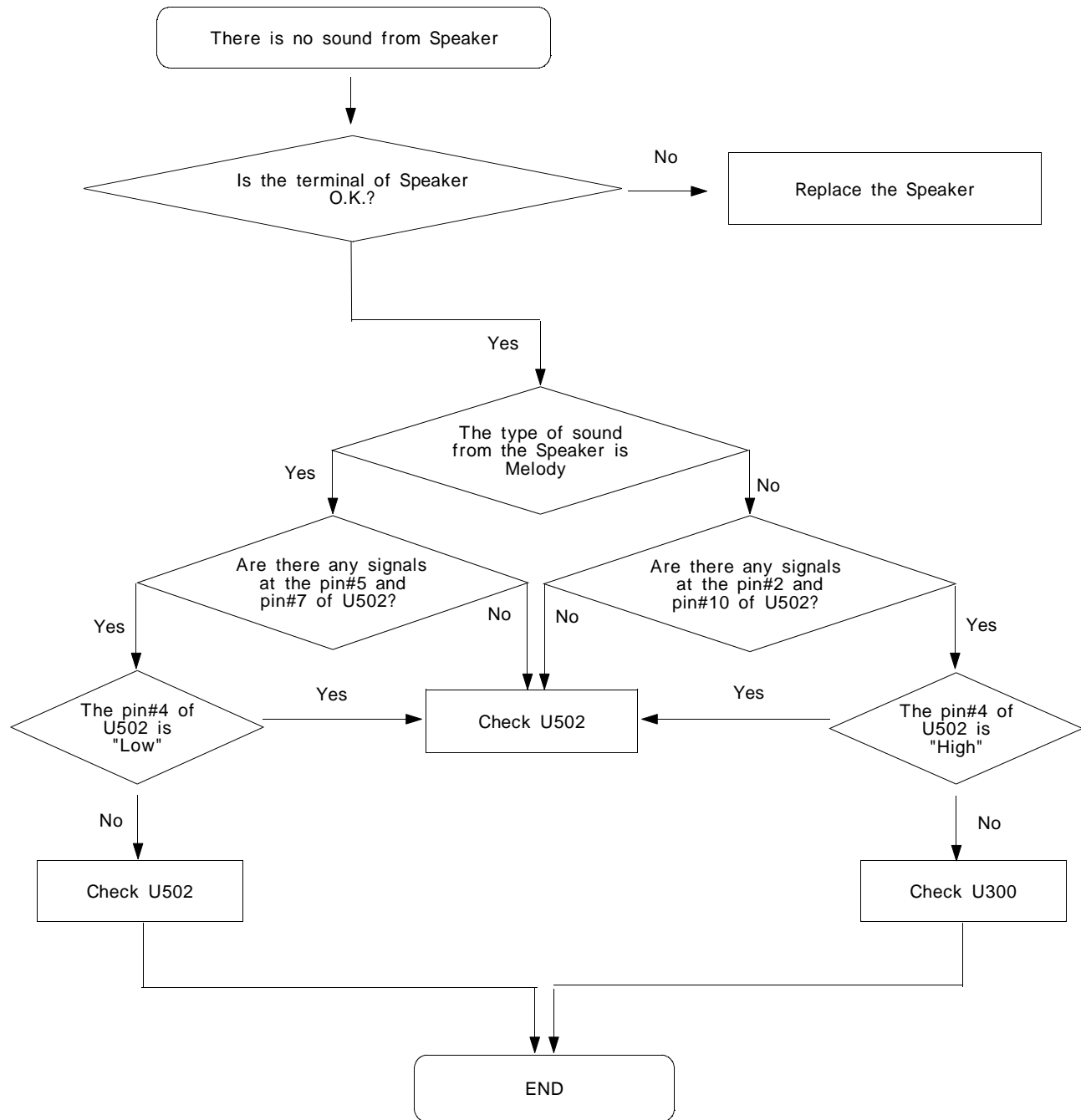

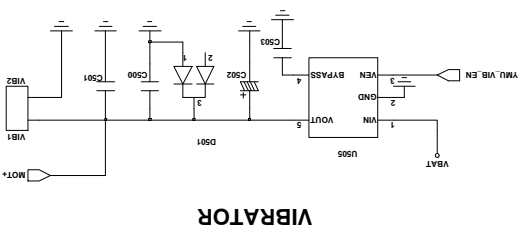
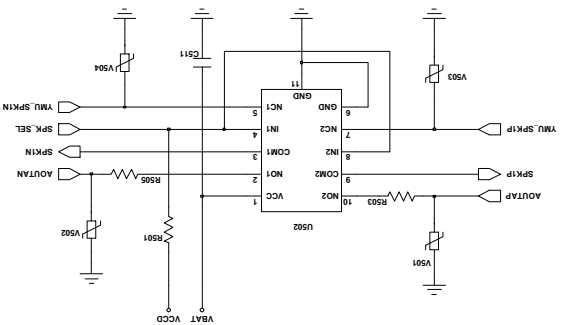

VIBRATOR

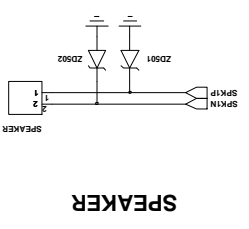

SPEAKER

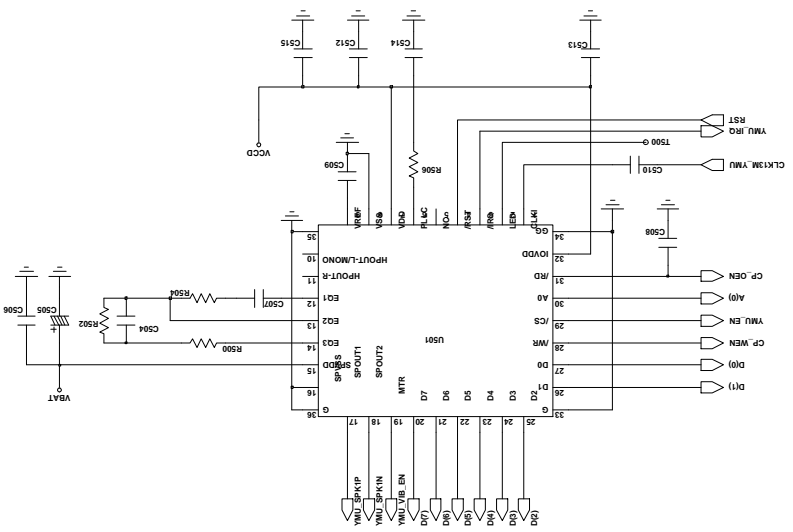

7-7. EGSM Reciever

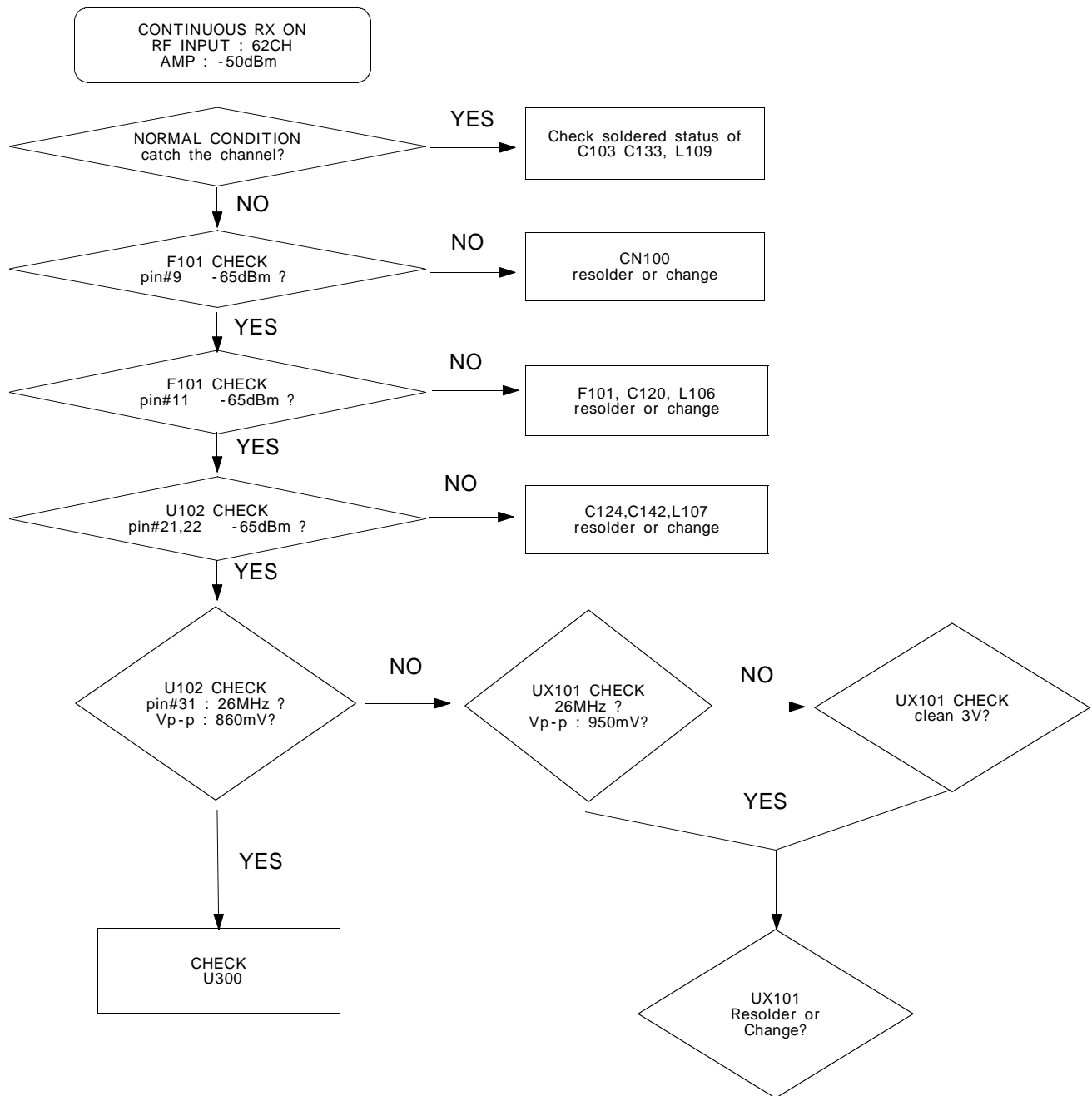

7-8. EGSM transmitter

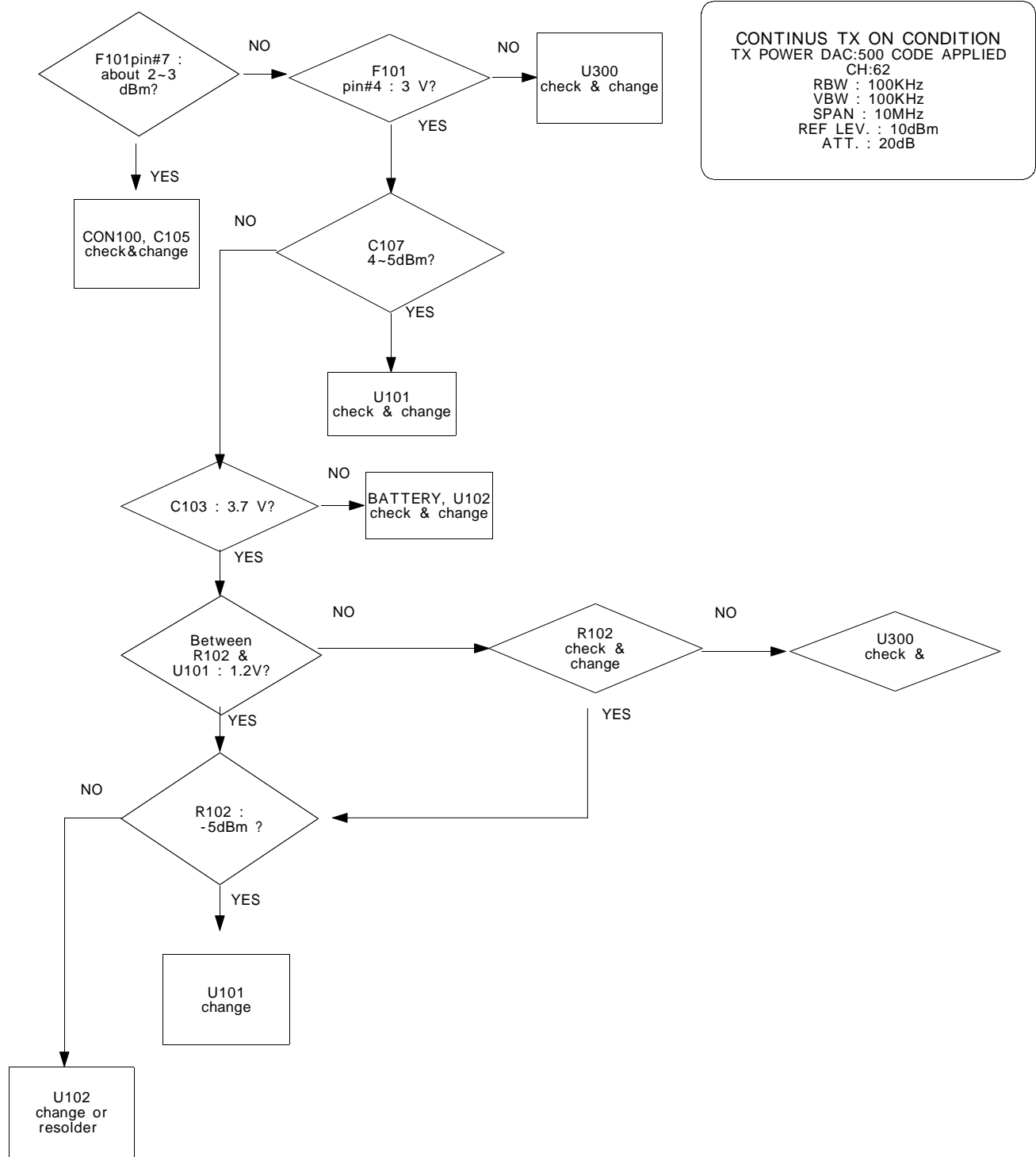

7-9. DCS Receiver

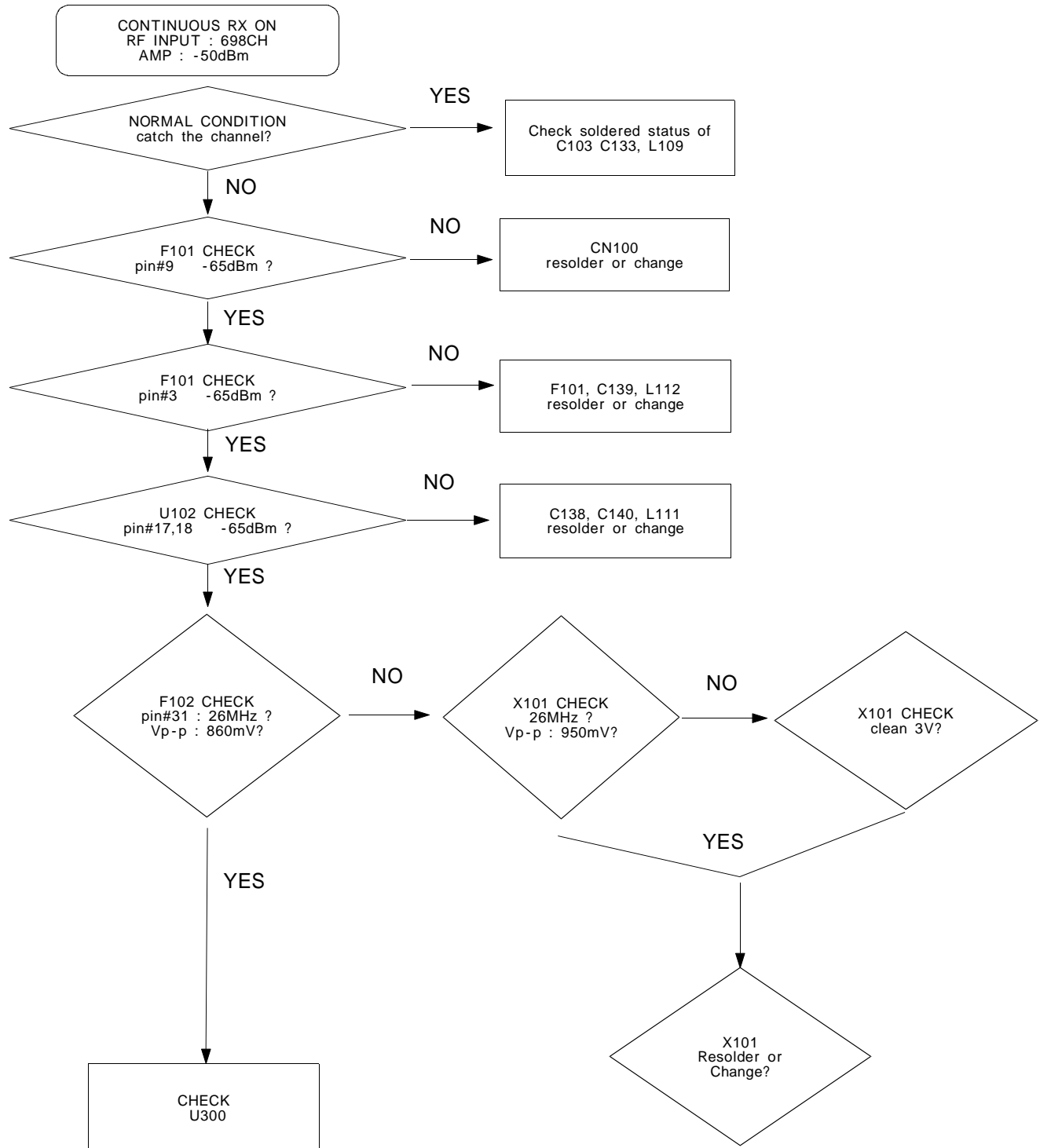

7-10. DCS transmitter

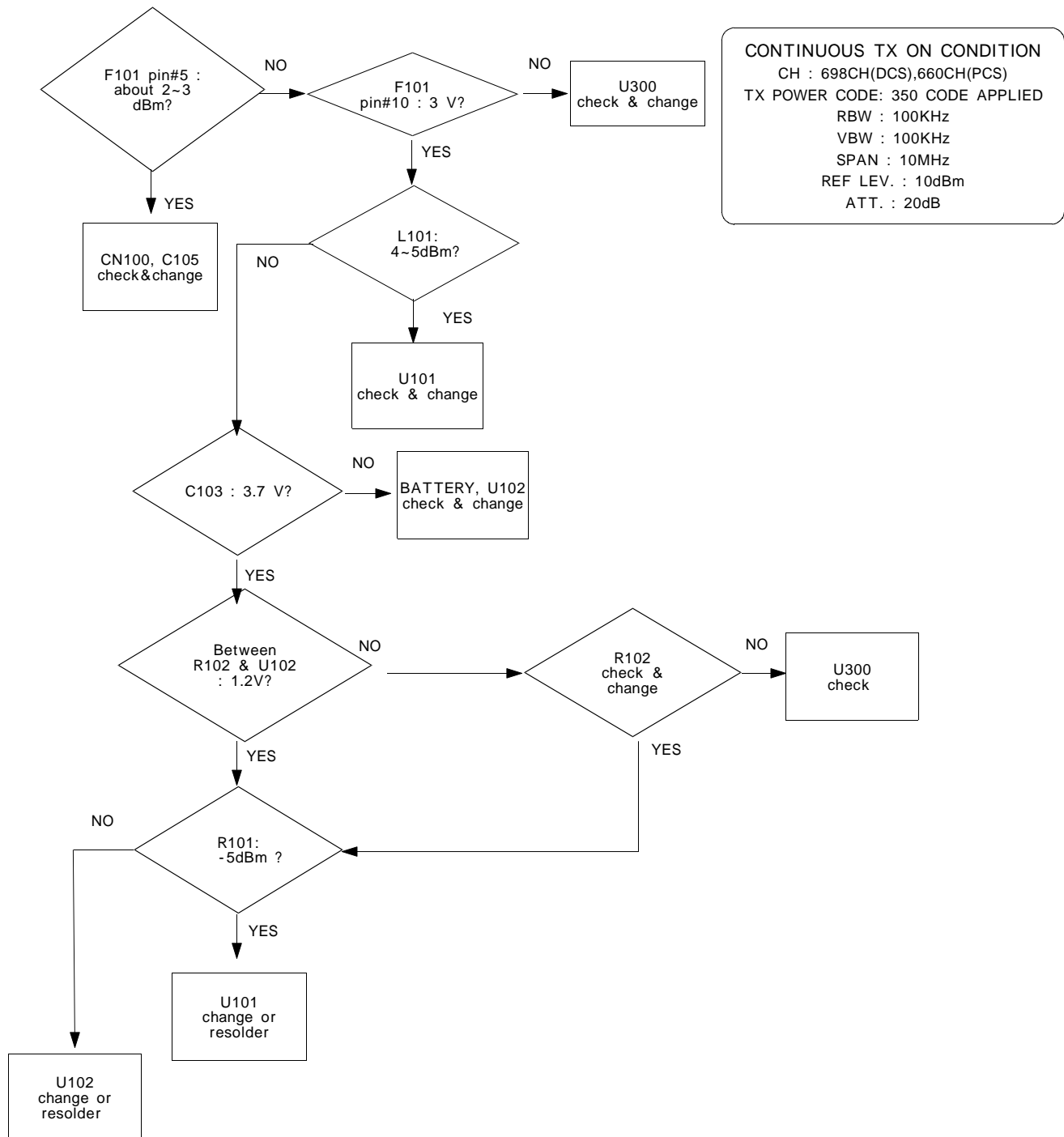

7-11. PCS Receiver

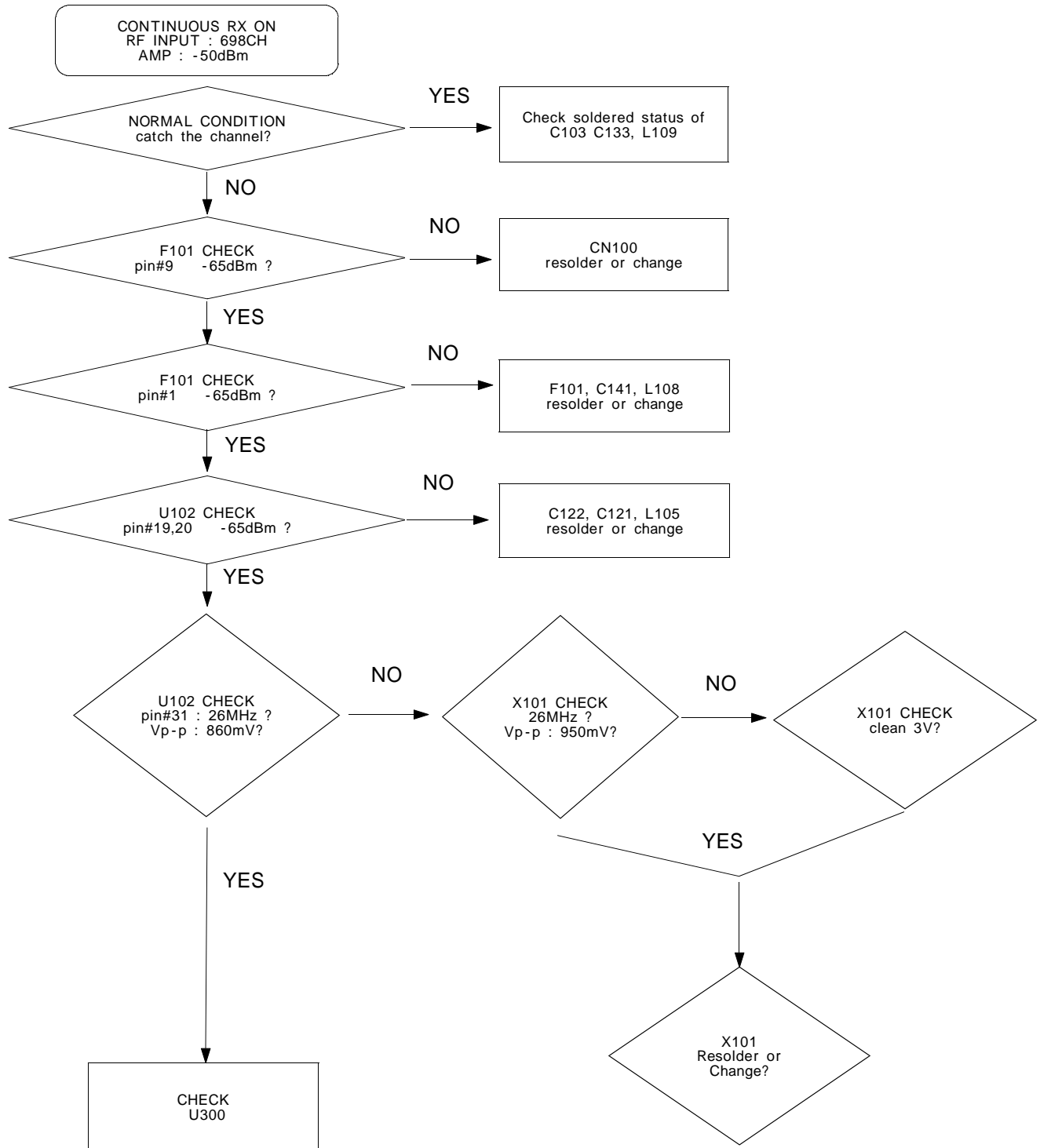

7-12. PCS transmitter

