

**SAMSUNG**

# GSM TELEPHONE

## SGH-C170

# **SERVICE** *Manual*

### GSM TELEPHONE



### CONTENTS

1. Specification
2. Exploded View and Parts list
3. Chart of Troubleshooting
4. Array course control
5. Block Diagrams
6. PCB Diagrams
7. MAIN Electrical Parts List
8. Reference data
9. Safety Precautions
10. Product Function

# Contents

## 1. Specification

1-1. GSM General Specification .....	1-1
1-2. GSM TX power class .....	1-2

## 2. Exploded View and Parts list

2-1. Cellular phone Exploded View .....	2-1
2-2. Cellular phone Parts list .....	2-2
2-3. Disassembly .....	2-9
2-4. Assembly .....	2-11

## 3. Chart of Troubleshooting

3-1. Baseband .....	3-1
3-1-1. Power ON .....	3-1
3-1-2. System Initial .....	3-5
3-1-3. SIM Part .....	3-8
3-1-5. Microphone Part .....	3-12
3-1-6. Receiver part .....	3-15
3-1-7. Speaker Part .....	3-18
3-2. RF .....	3-13
3-2-1. EGSM Rx .....	3-23
3-2-2. DCS Rx .....	3-24
3-2-3. EGSM Tx.....	3-25
3-2-4. DCS Tx .....	3-27

---

# Contents

## 4. Array course control

4-1. Downloading Binary Files .....	4-2
4-2. Pre-requisite for Downloading .....	4-2
4-3. S/W Downloader Program .....	4-3

## 5. Block Diagrams

## 6. PCB Diagrams

## 7. MAIN Electrical Parts List

## 8. Reference data

8-1. Reference Abbreviate .....	8-1
---------------------------------	-----

## 9. Safety Precautions

9-1. Repair Precaution .....	9-1
9-2. ESD(Electrostatically Sensitive Devices) Precaution .....	9-2

## 10. Product Function

---

---

# 1. Specification

---

## 1-1. GSM General Specification

	EGSM 900 Phase 2	DCS1800 Phase 1
Freq. Band[MHz] Uplink/Downlink	880~915 925~960	1710~1785 1805~1880
ARFCN range	0~124 & 975~1023	512~885
Tx/Rx spacing	45 MHz	95 MHz
Mod. Bit rate/ Bit Period	270.833 kbps 3.692 us	270.833 kbps 3.692 us
Time Slot Period/Frame Period	576.9 us 4.615 ms	576.9 us 4.615 ms
Modulation	0.3 GMSK	0.3 GMSK
MS Power	33 dBm~5 dBm	30 dBm~0 dBm
Power Class	5 pcl ~ 19 pcl	0 pcl ~ 15 pcl
Sensitivity	-102 dBm	-100 dBm
TDMA Mux	8	8
Cell Radius	35 Km	2 Km

## 1-2. GSM Tx Power Class

<b>TX Power control level</b>	<b>GSM900</b>	<b>TX Power control level</b>	<b>DCS1800</b>
5	33±2 dBm	0	30±3 dBm
6	31±2 dBm	1	28±3 dBm
7	29±2 dBm	2	26±3 dBm
8	27±2 dBm	3	24±3 dBm
9	25±2 dBm	4	22±3 dBm
10	23±2 dBm	5	20±3 dBm
11	21±2 dBm	6	18±3 dBm
12	19±2 dBm	7	16±3 dBm
13	17±2 dBm	8	14±3 dBm
14	15±2 dBm	9	12±4 dBm
15	13±2 dBm	10	10±4 dBm
16	11±3 dBm	11	8±4 dBm
17	9±3 dBm	12	6±4 dBm
18	7±3 dBm	13	4±4 dBm
19	5±3 dBm	14	2±5 dBm
		15	0±5 dBm

## 2. Exploded View and Parts List

### 2-1. Cellular phone Exploded View

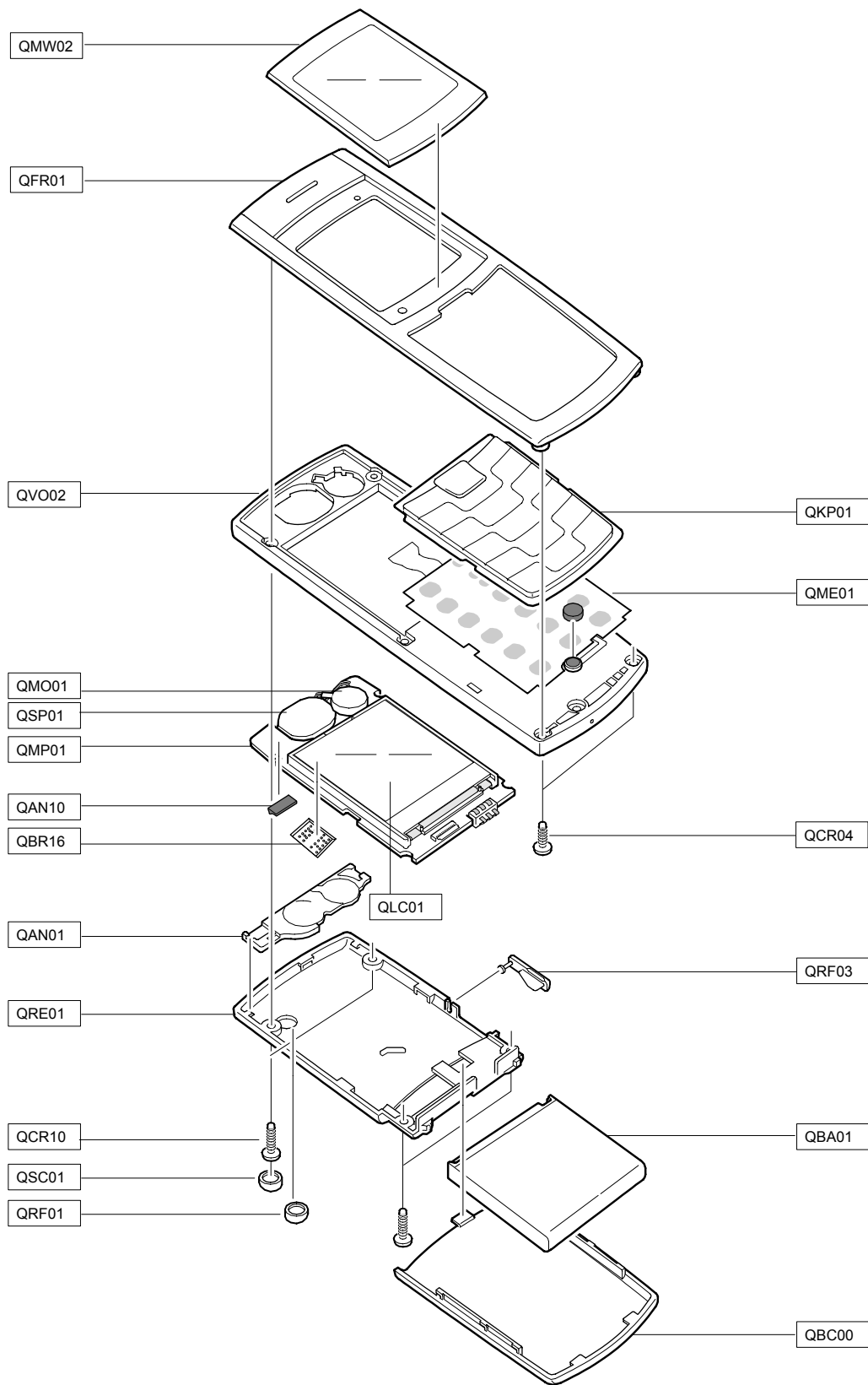

**2-2. Cellular phone Parts list**

Design LOC		Discription	SEC CODE
QAN01		ANTENNA-SGHC170	GH42-01155A
QAN10		ASSY-CUSHION-ANT CONTACT RUBBE	GH98-01218A
QBA01		INNER BATTERY PACK-730MAH,BLK,	GH43-02811A
QBC00		PMO-COVER BATTERY	GH72-38254A
QBR16		IPR-BRACKET LID	GH70-02201A
QCR04		SCREW-MACHINE	6001-001479
QCR10		SCREW-MACHINE	6001-001633
QFR01		ASSY CASE-FRONT	GH98-04178A
QKP01		ASSY KEYPAD-(SER/ZR)	GH98-04525A
QLC01		LCD-MAIN MODULE (SGHC170)	GH07-01085A
QME01		UNIT-KEY PBA	GH59-03873A
QMO01		MOTOR DC-SGH-C170	GH31-00333A
QMP01		PBA MAIN-SGHC170 (PBA MAIN)	GH92-03260A
QMW02		PMO-COVER MIAN WINDOW	GH72-38551A
QRF01		PMO-COVER RF	GH72-38552A
QSC01		RMO-SCREW CAP	GH73-09347A
QSP01		SPEAKER	3001-002119
QVO02		ASSY CASE-BELT	GH98-04179A
QRE01		ASSY CASE-REAR	GH98-04180A
	QRF03	PMO-COVER EAR	GH72-38253A

---

Discription	SEC CODE
BAG PE	6902-000297
ADAPTOR-SGHE690,BLK,EU,A_TYPE	GH44-01361A
UNIT-20P,EARPHONE,BLK,B-TYPE	GH59-04029A
MANUAL-SFC	GH68-04336A
LABEL(P)-BARCODE RUSSIA	GH68-08494A
LABEL(R)-WATER SOAK	GH68-09361A
MANUAL USERS-EU RUSSIAN	GH68-13837A
LABEL(R)-MAIN(SER)	GH68-13958B
BOX(P)-UNIT MAIN(SER)	GH69-05058B
MPR-GASKET TAPE	GH74-27014A
MPR-TAPE MAIN WINDOW	GH74-31056A
TAPE INSU	GH74-33024A

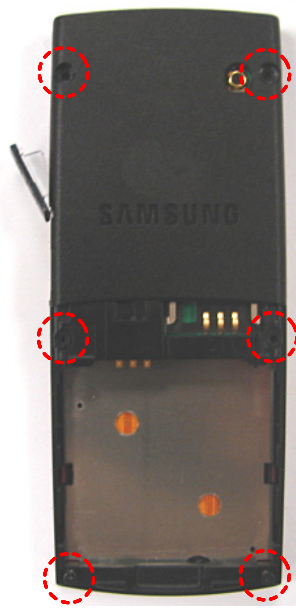
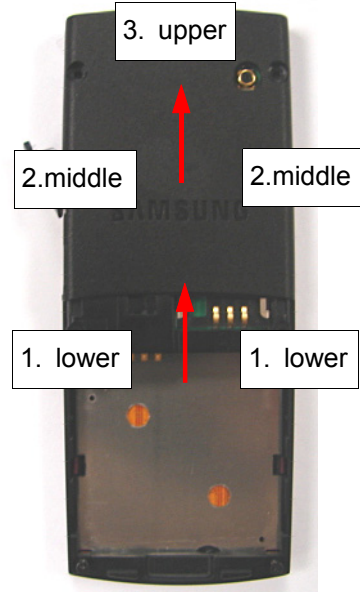
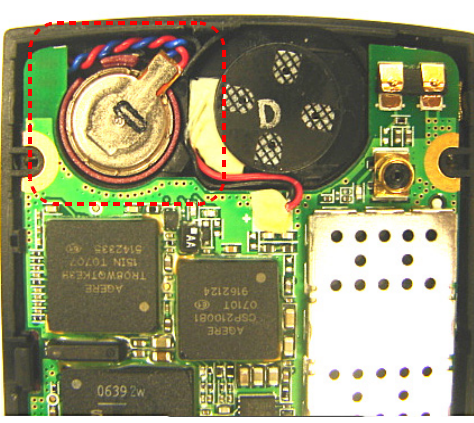
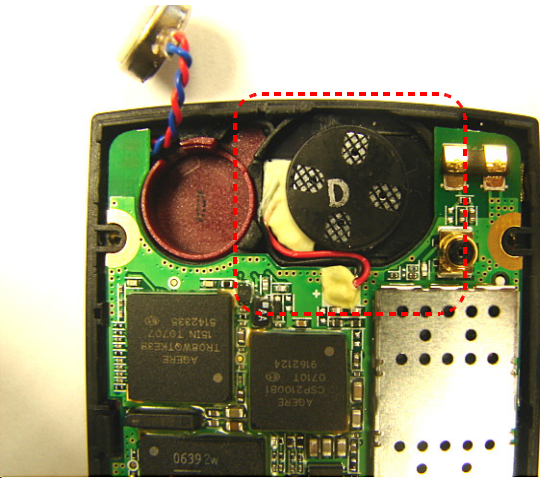

### 2-3. Disassembly

<p><b>1</b></p> 	<p><b>2</b></p> 
<p>Removal of SCREW Remove SCREWS (6 POINT).</p>	<p>Disassembly of REAR Disassemble REAR LOCKING PARTs from lower to upper side by using a disassembly stick.</p>
<p><b>3</b></p> 	<p><b>4</b></p> 
<p>Disassembly of MOTOR Remove MOTOR by using tweezers. ※ caution Be careful not to damage MOTOR wires.</p>	<p>Disassembly of SPEAKER Remove SPEAKER by using tweezers. ※ caution Be careful not to damage SPEAKER wires.</p>

5

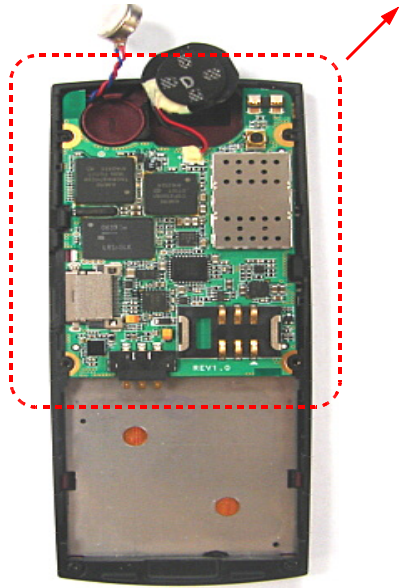

Removal of PBA  
Remove PBA from the external part.

6

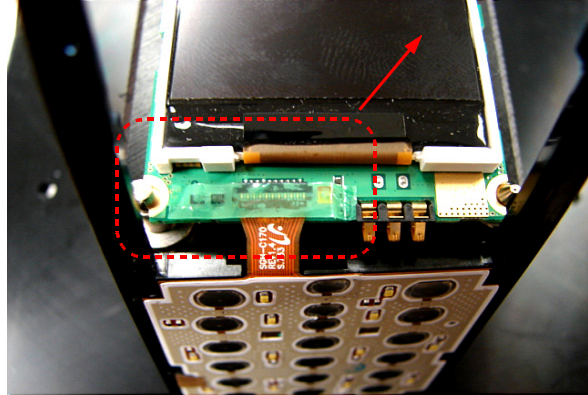

Removal of disassembling preventive TAPE.  
Remove disassembling preventive TAPE by using tweezers.

7

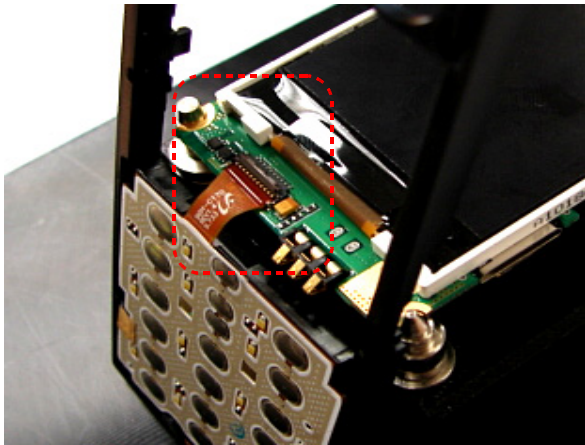

Disassembly of CONNECTOR  
Remove 3\*4 KEY F-PCB from CONNECTOR.  
※ **caution**  
Be careful not to damage Key-FPCB.

8

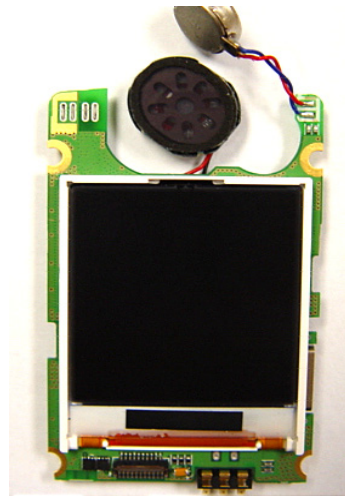

Disassembly of PBA ASS'Y  
The disassembled state of 3\*4 KEY and PBA ASS'Y.

9

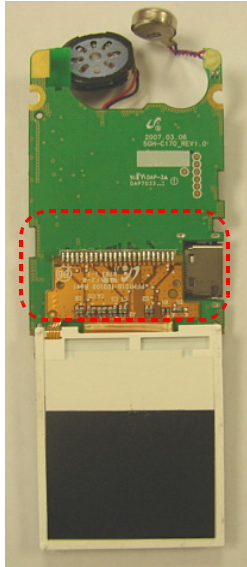



Removal of LCD MODULE

- 1.Remove SOLDERING Part of LCD MODULE.
- 2.Remove LCD MODULE.

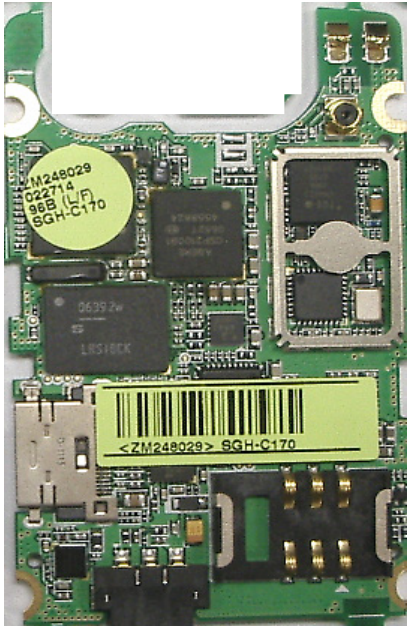
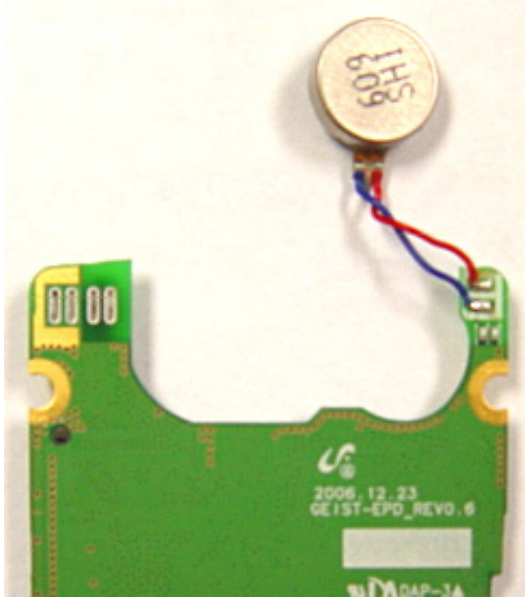
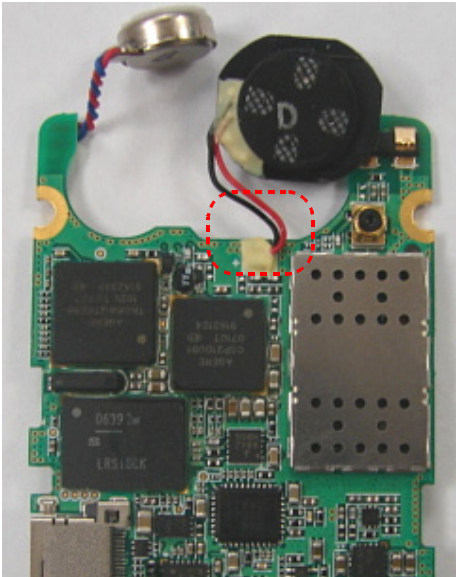
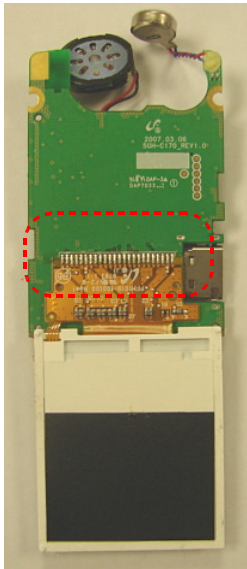
## 2-4. Assembly

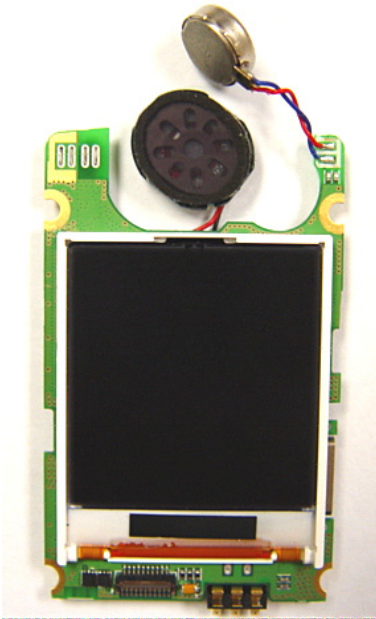
<p><b>1</b></p> 	<p><b>2</b></p> 
<p>Ready for PBA Ready for PBA.</p>	<p><b>MOTOR SOLDERING</b> Solder MOTOR as you see above.</p>
<p><b>3</b></p> 	<p><b>4</b></p> 
<p><b>SPEAKER SOLDERING</b> Solder SPEAKER as you see above.</p>	<p>Inserting LCD MODULE into to the external part a. Remove cover tape and place LCD FPCB along to the slipline. b. Put PBA into to the Soldering Jig and solder LCD-FPCB to the PCB.</p>

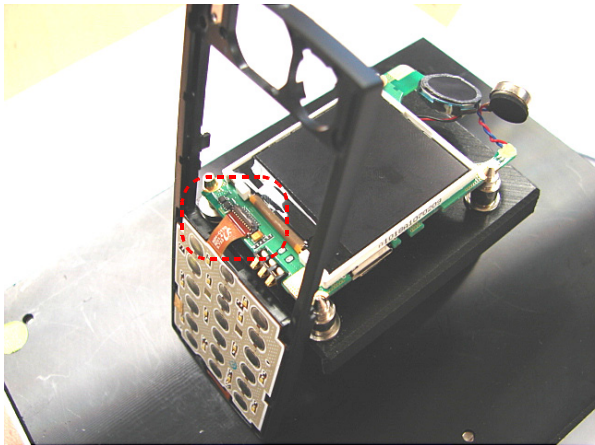
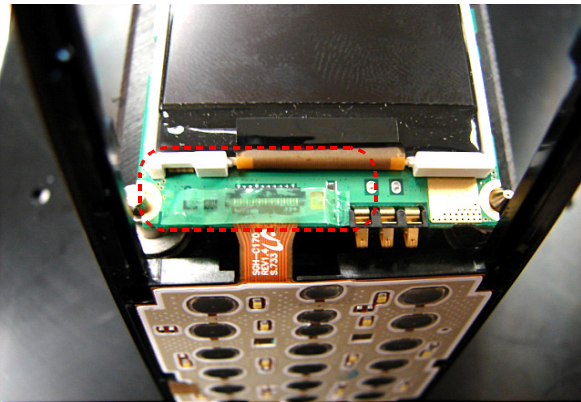
<p><b>5</b></p> 	<p><b>6</b></p> 
<p>Assembly of LCD  a. Remove double stick tape on the back of LCD  b. Assemble LCD to the PBA</p>	<p>Assembly of KEY PCB / TAPE  a. Put KEY PCB according to base holes as you see above.  b. Put conductive tape as you see above.</p>
<p><b>7</b></p> 	<p><b>8</b></p> 
<p>Assembly of Key-FPCB  Assemble 3*4 KEY F-PCB to the CONNECTOR as you see above.</p>	<p>Attaching of disassembling preventive TAPE  Attach disassembling preventive TAPE on the CONNECTOR.</p>

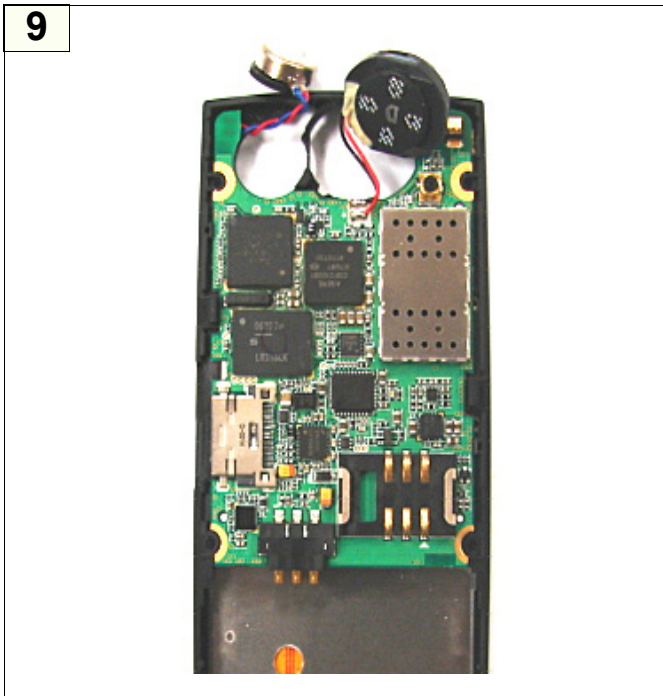

Assembly of PBA  
Insert PBA into the external part

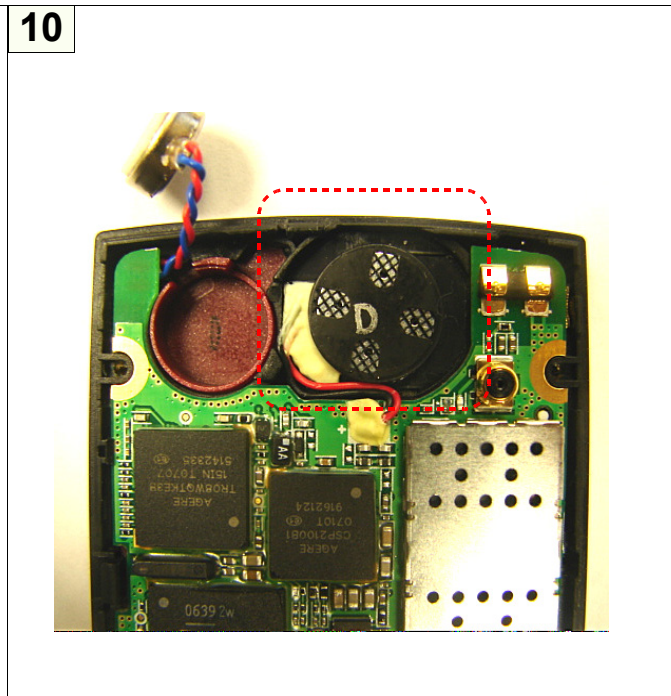

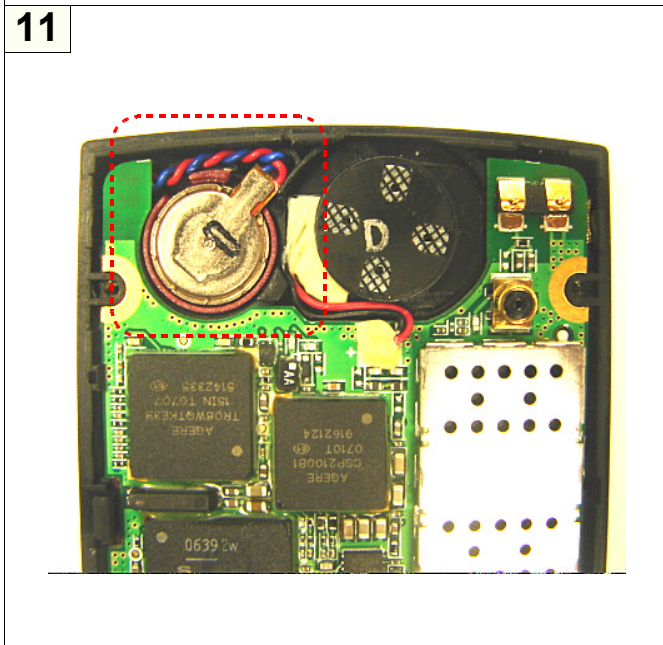

Assembly of SPEAKER  
Assemble SPEAKER into the external part



Assembly of MOTOR  
Assemble MOTOR into the external part

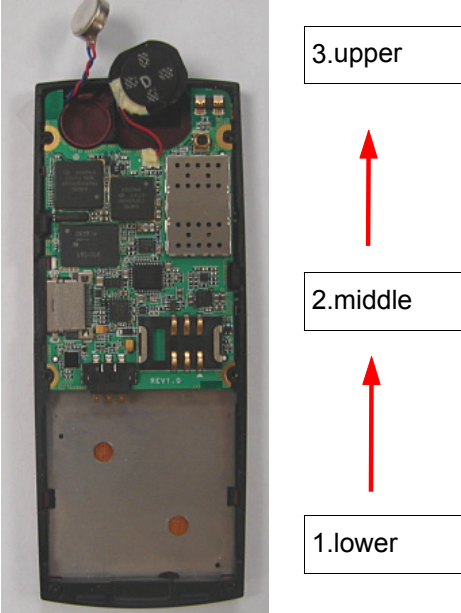
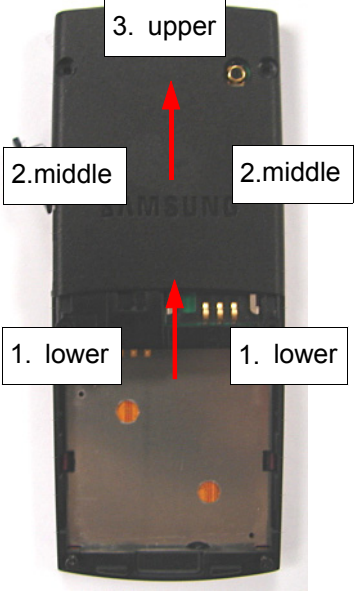

Assembly of KEY PAD  
Put KEY PAD into the FRONT as you see above.

<p><b>13</b></p>  <p>3.upper</p> <p>2.middle</p> <p>1.lower</p>	<p><b>14</b></p>  <p>3. upper</p> <p>2.middle</p> <p>2.middle</p> <p>1. lower</p> <p>1. lower</p>
<p>Assembly of PBA Put PBA from lower to upper side.</p>	<p>Assembly of REAR Put REAR as you see above → From upper to lower side</p>
<p><b>15</b></p> 	
<p>Assembly of SCREW Put the SCREWS into the holes(6 POINT).</p>	

# 3. Flow Chart of Troubleshooting

## 3-1. Baseband

### 3-1-1. Power ON

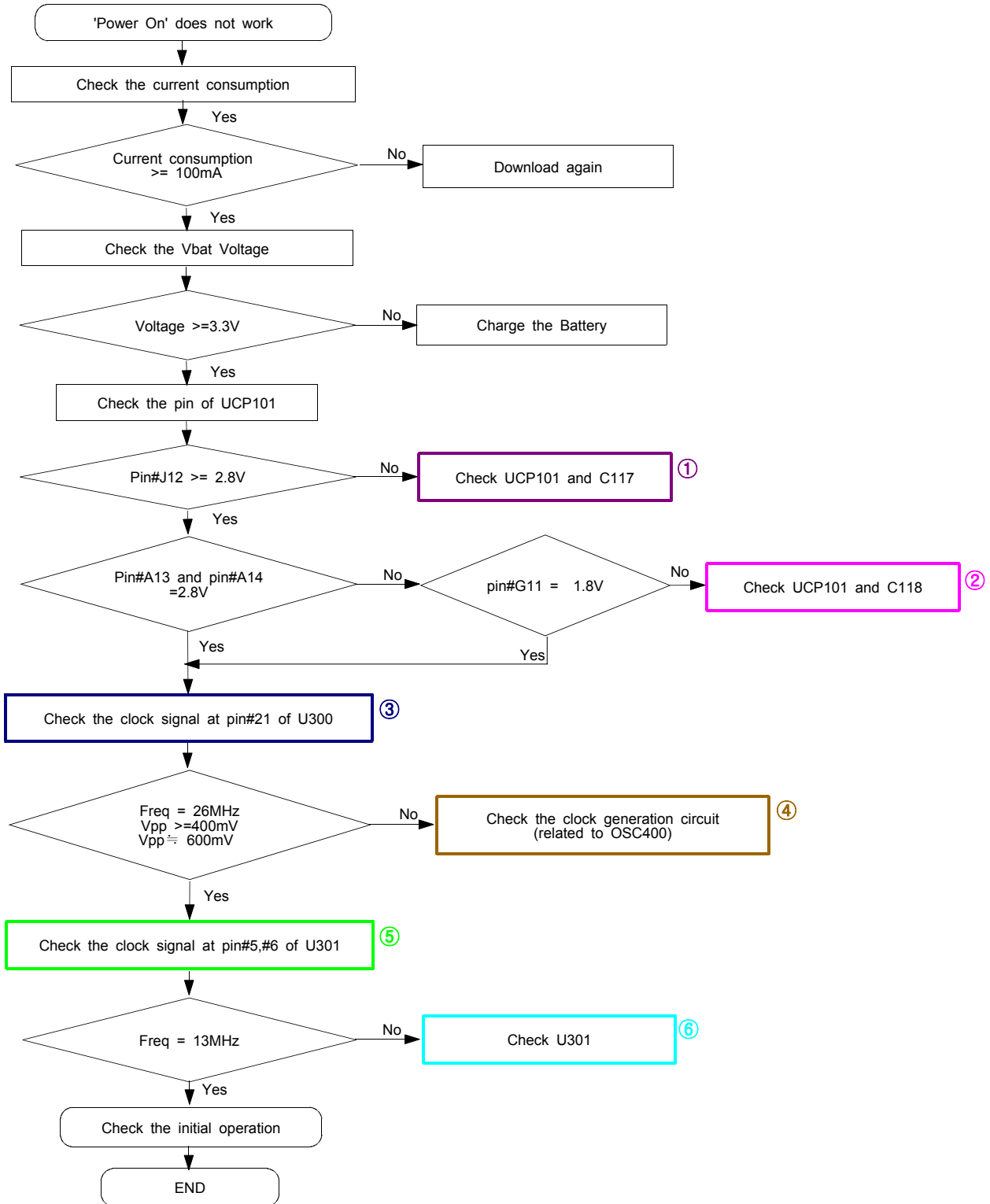



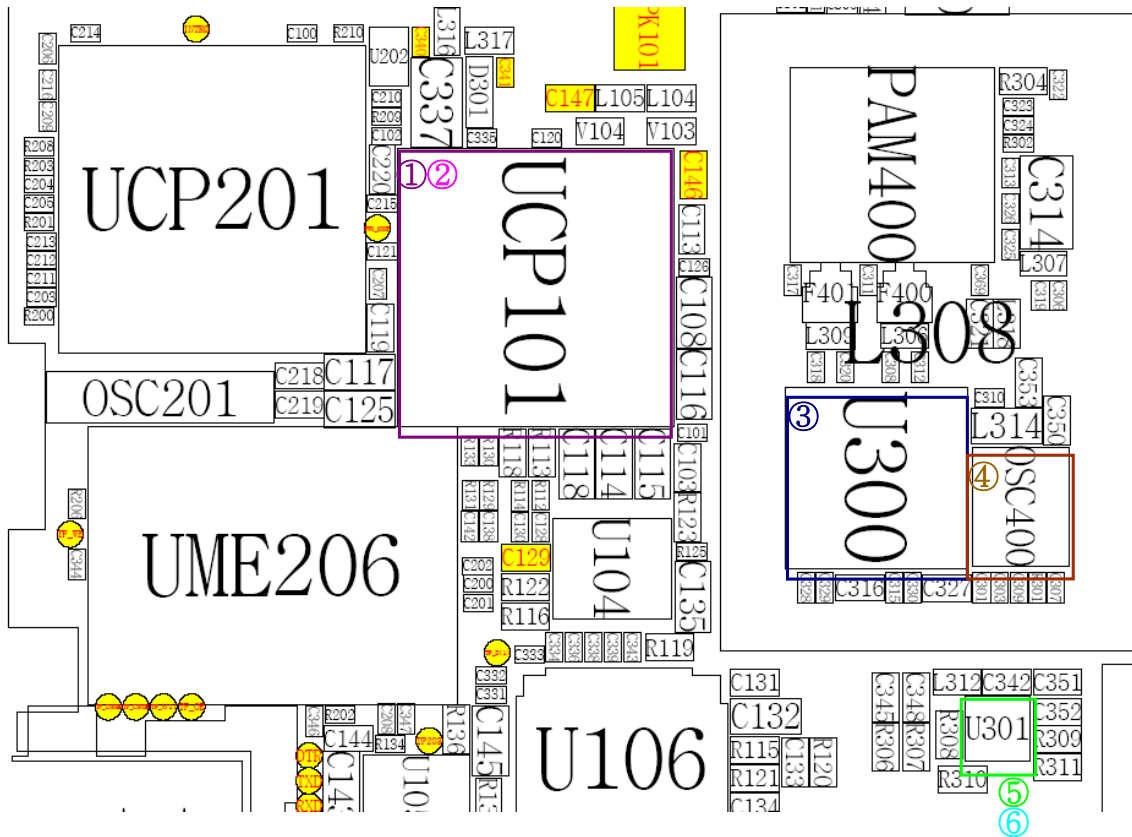

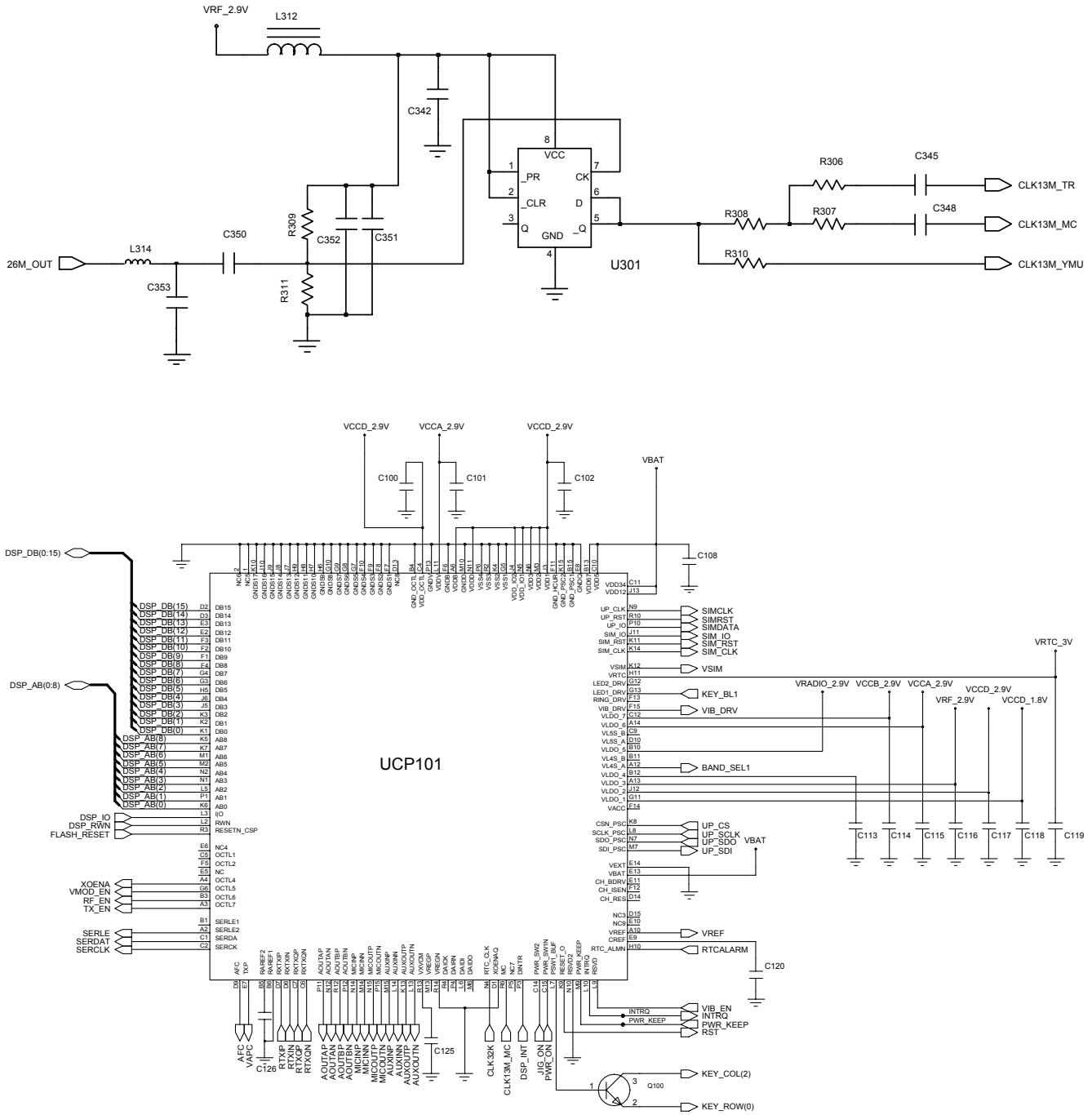

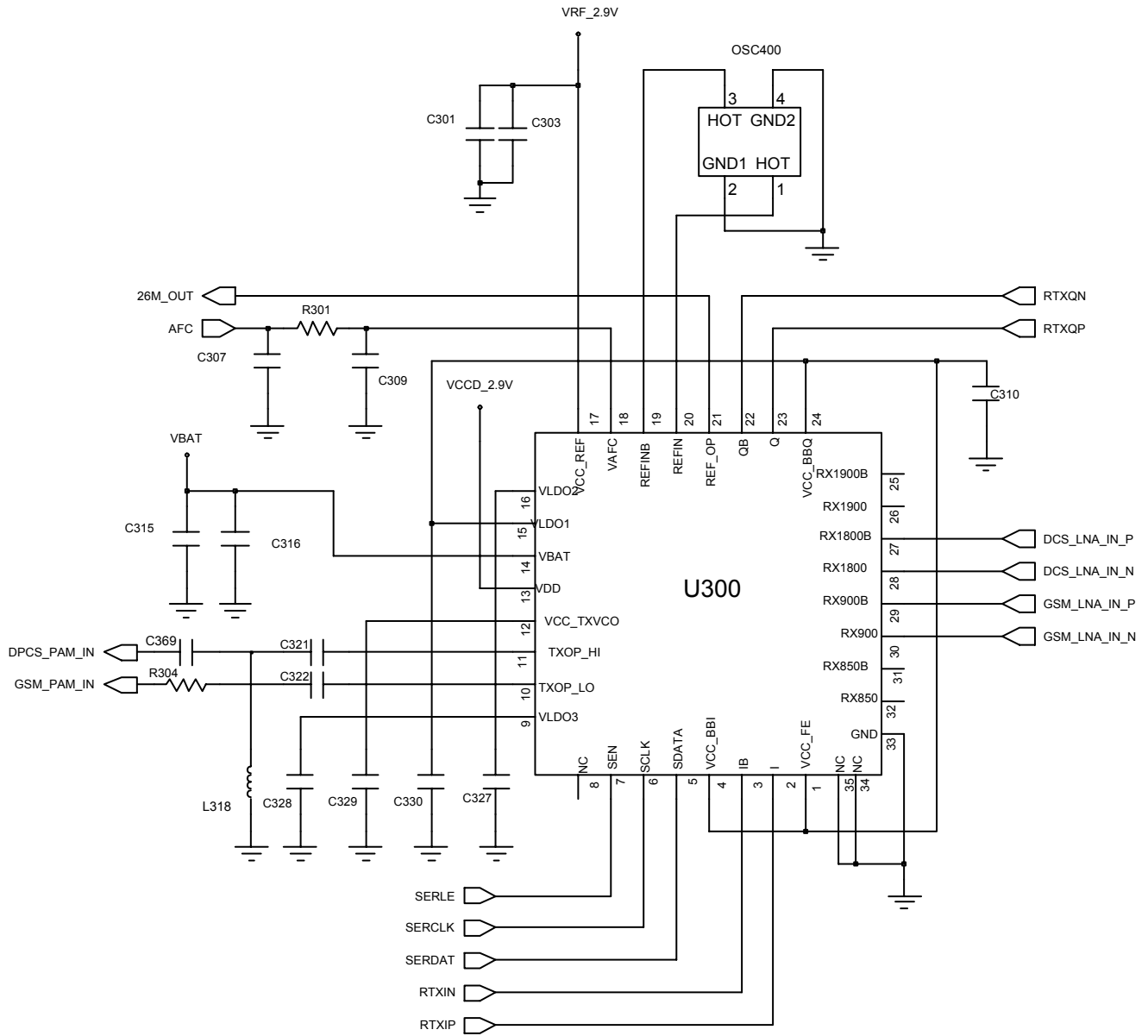

### 3-1-2. Initial

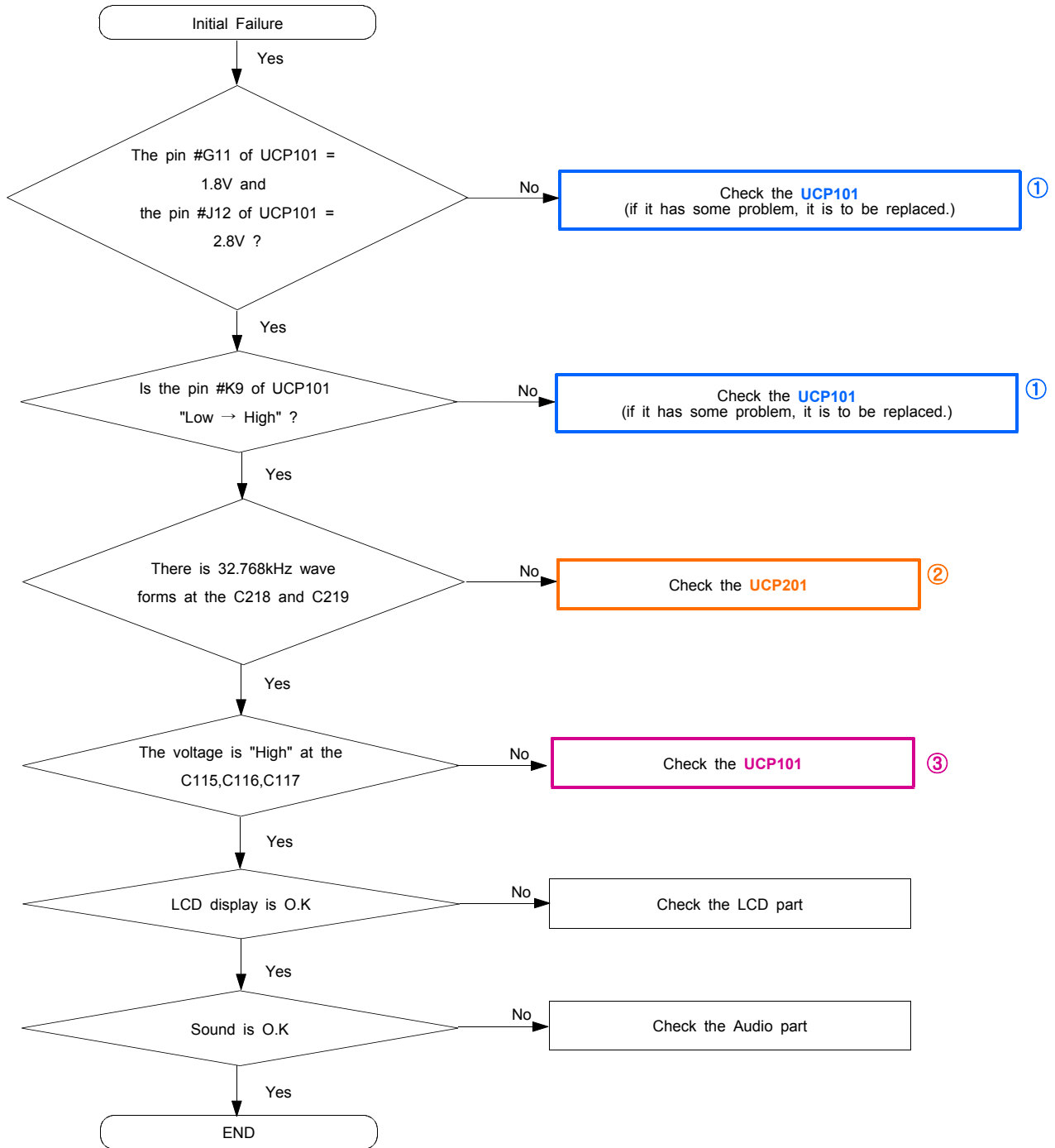

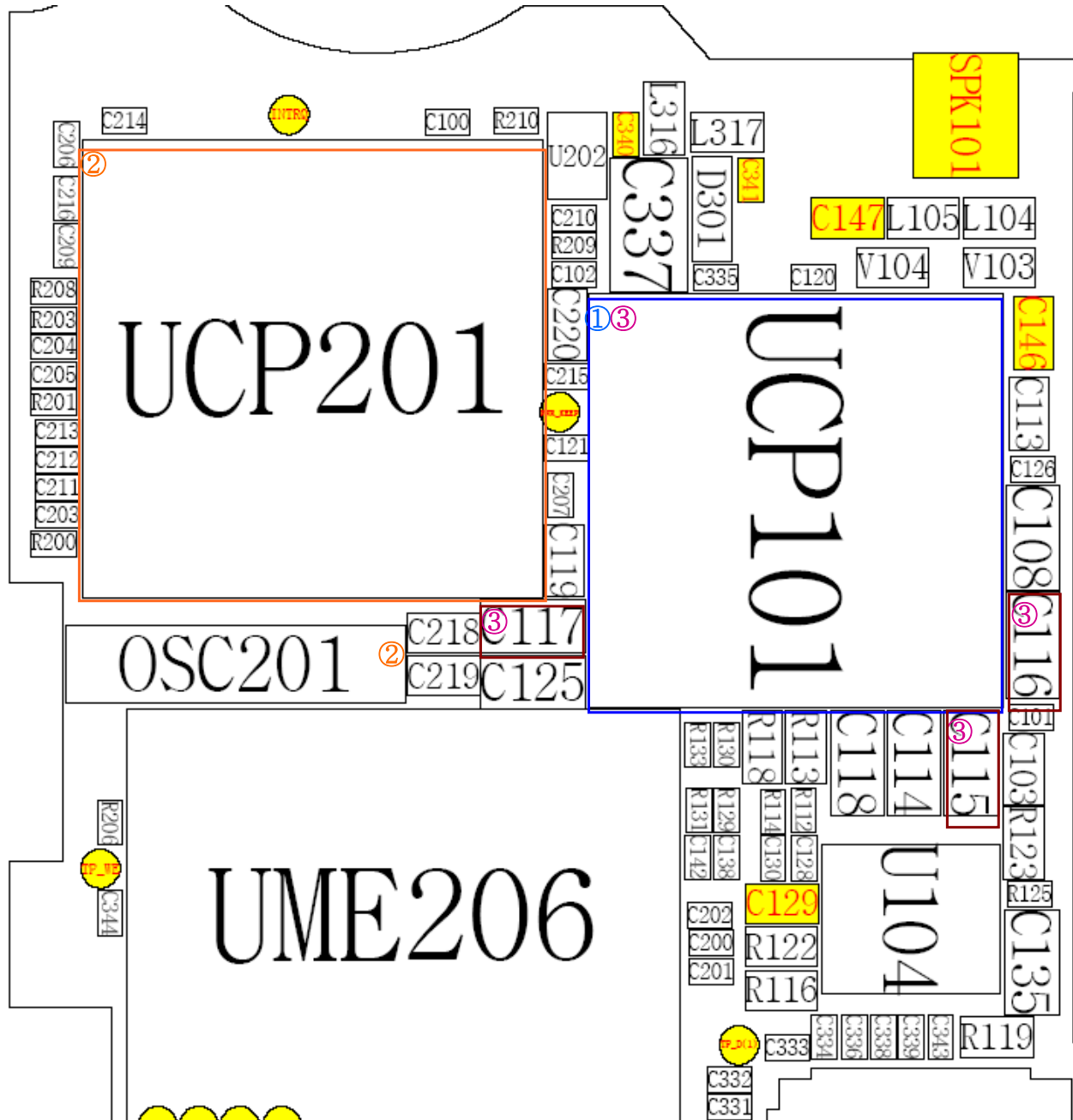

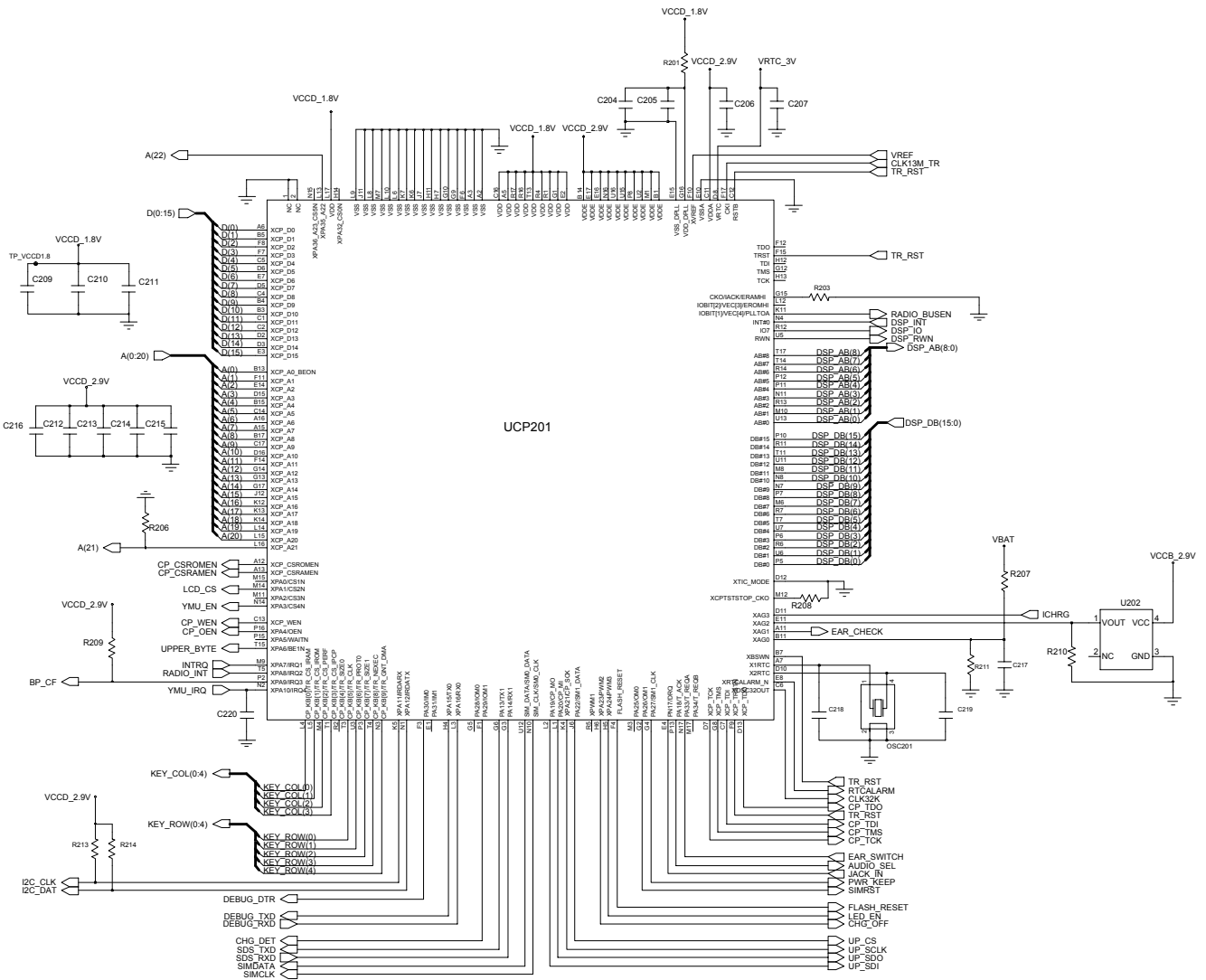

### 3-1-3. Sim Part

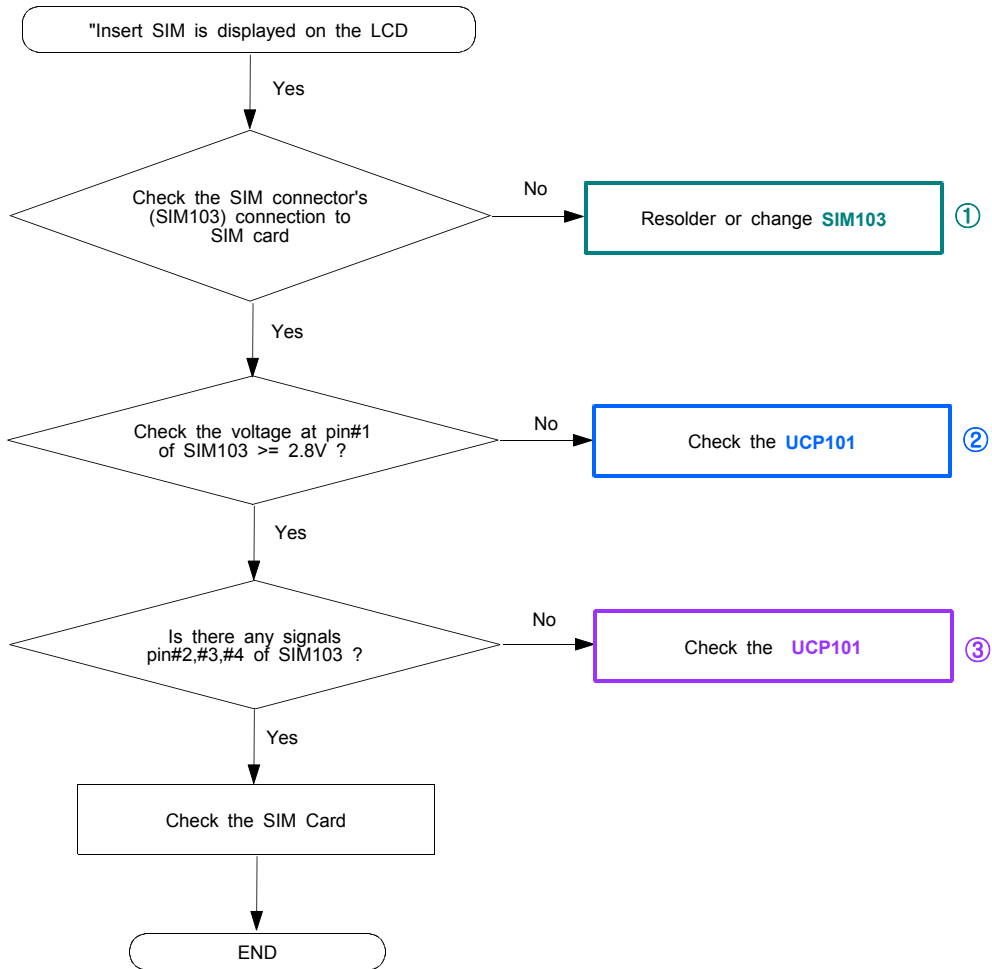





### 3-1-4. Microphone Part

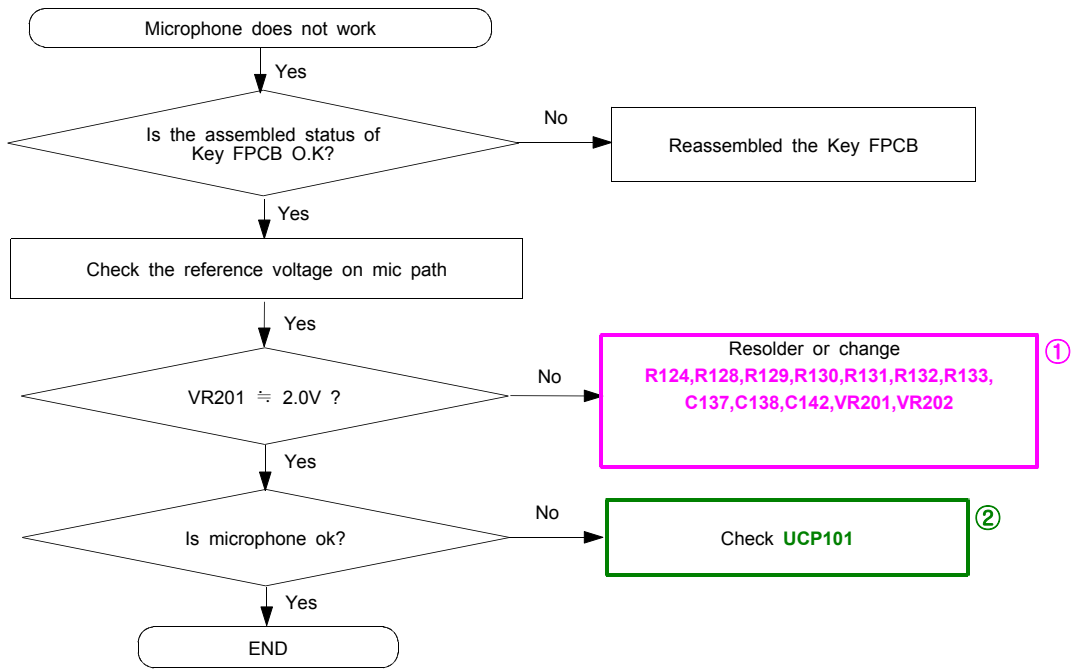

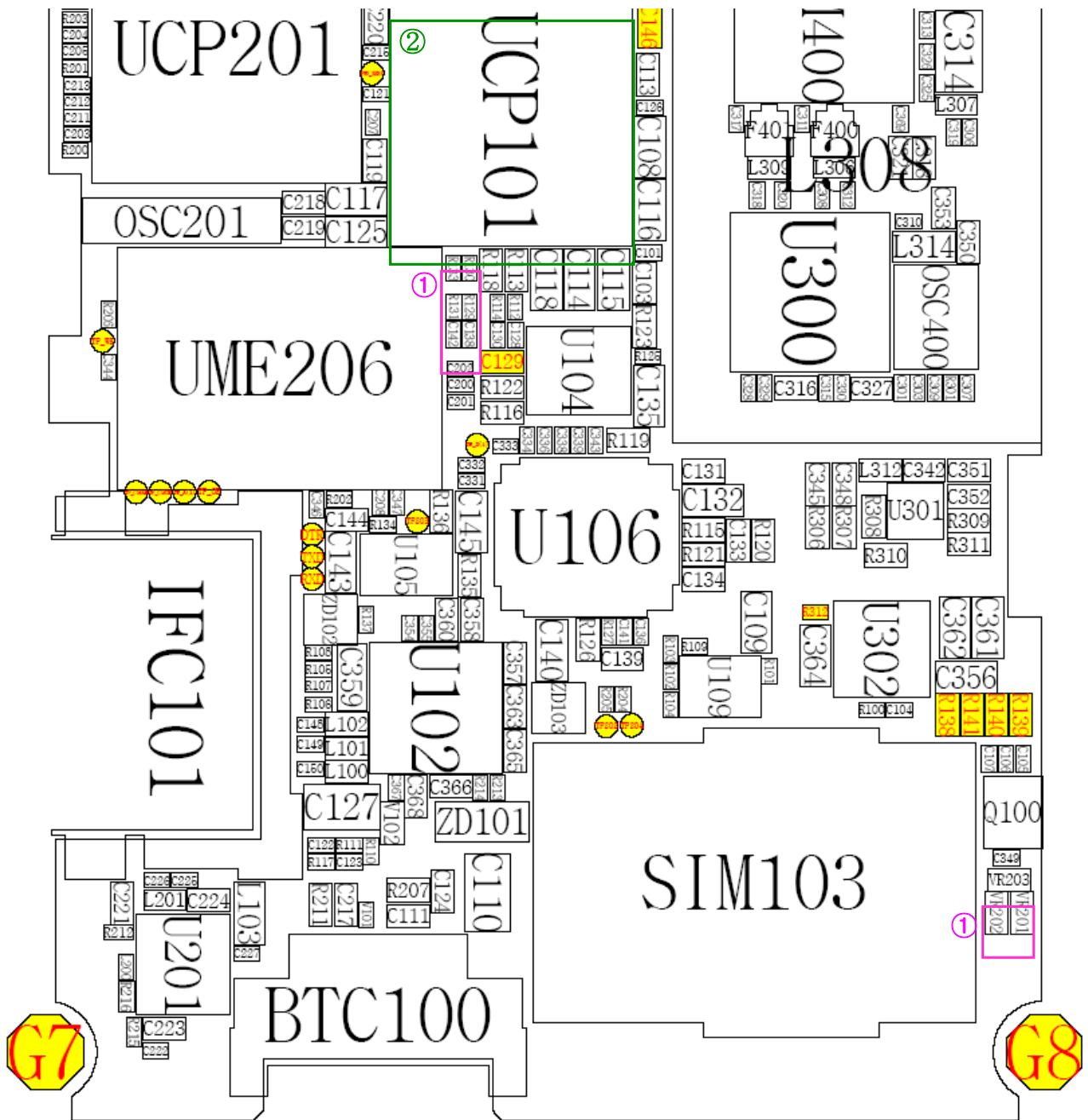
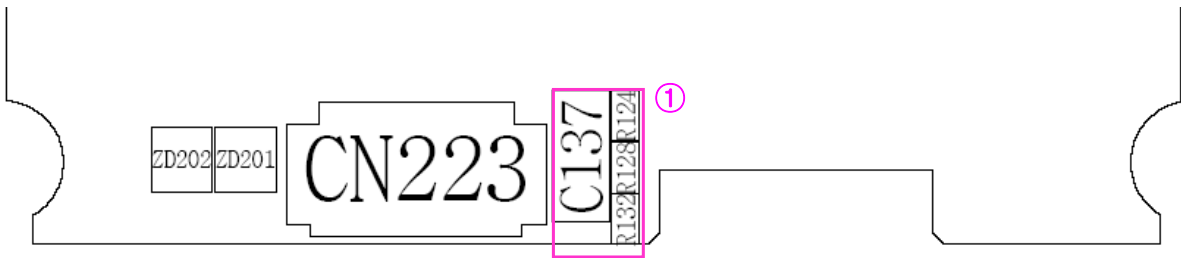

### 3-1-5. Receiver Part

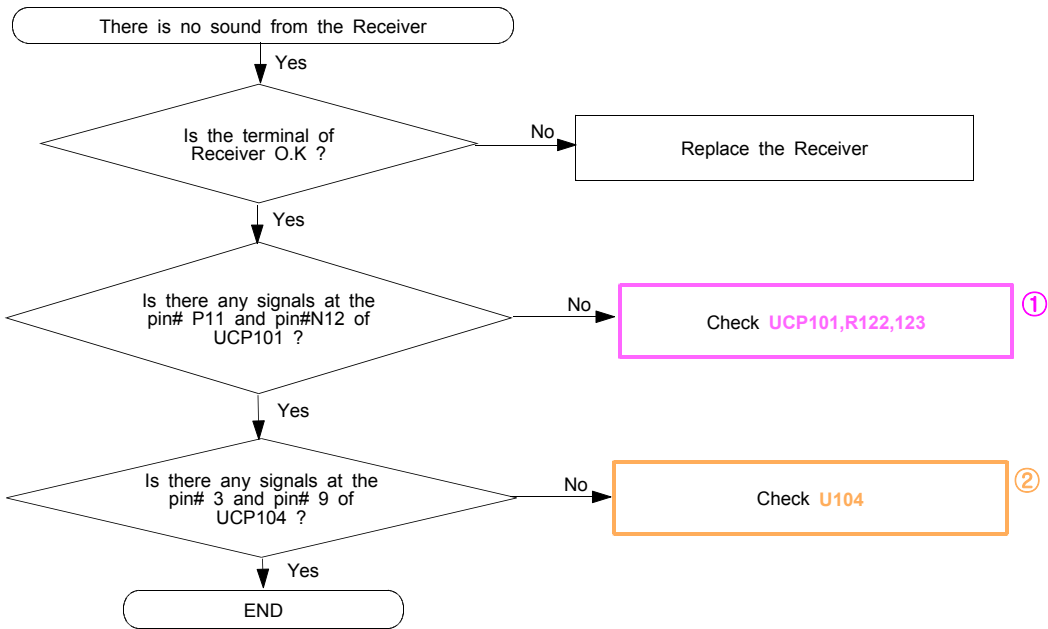

### 3-1-6. Speaker Part

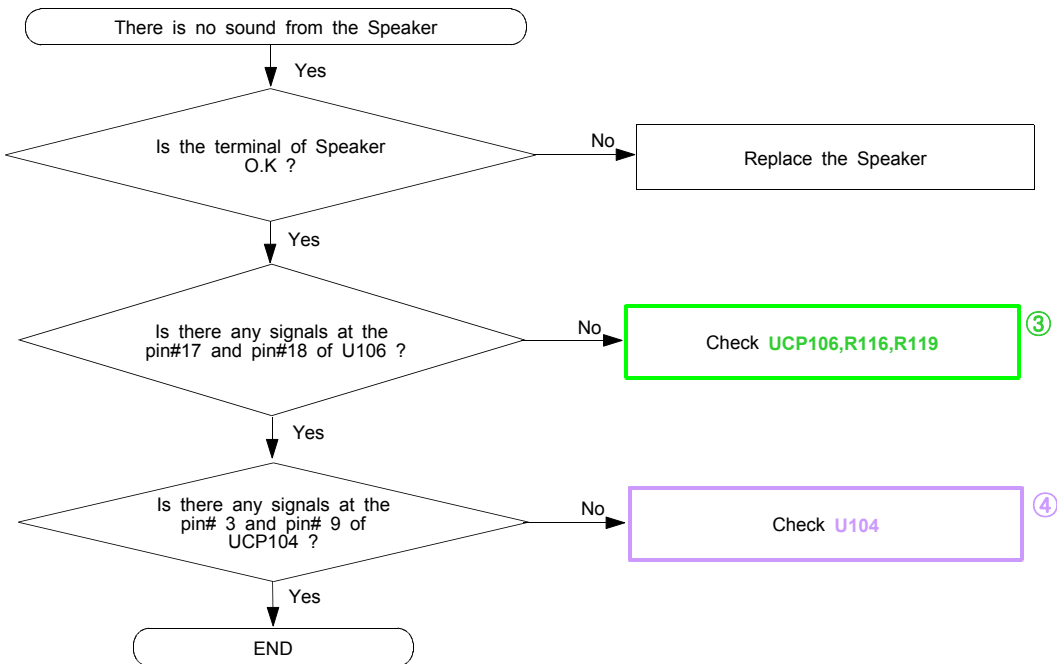

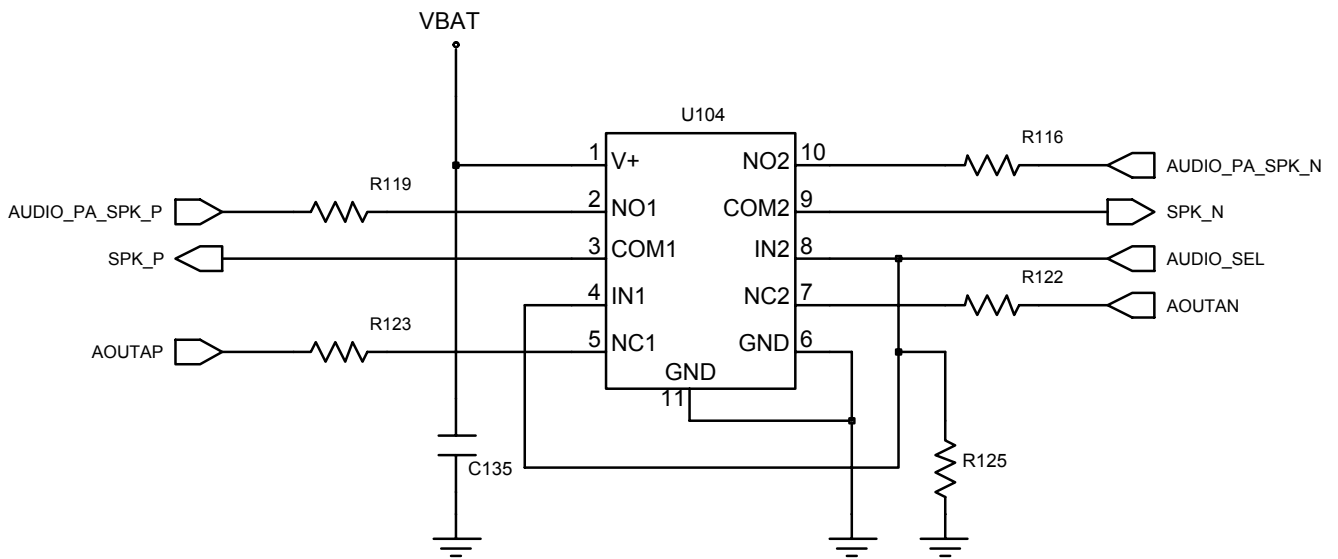
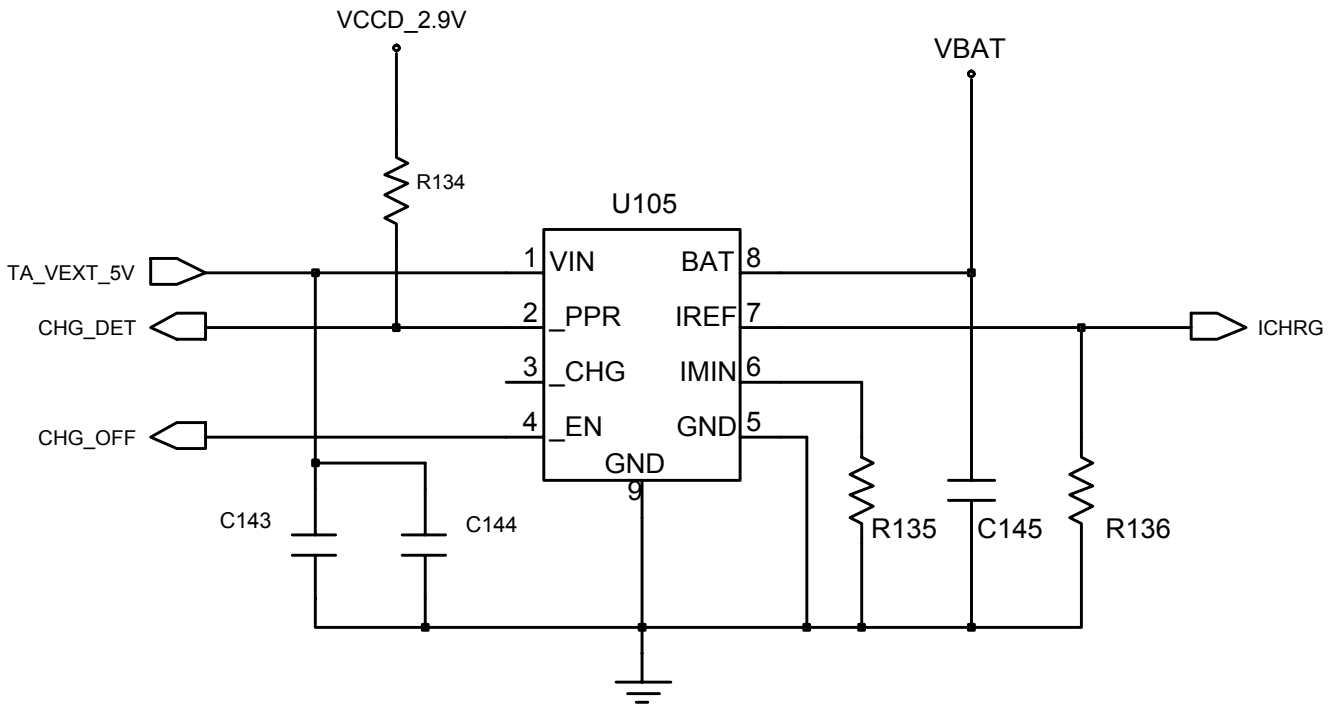

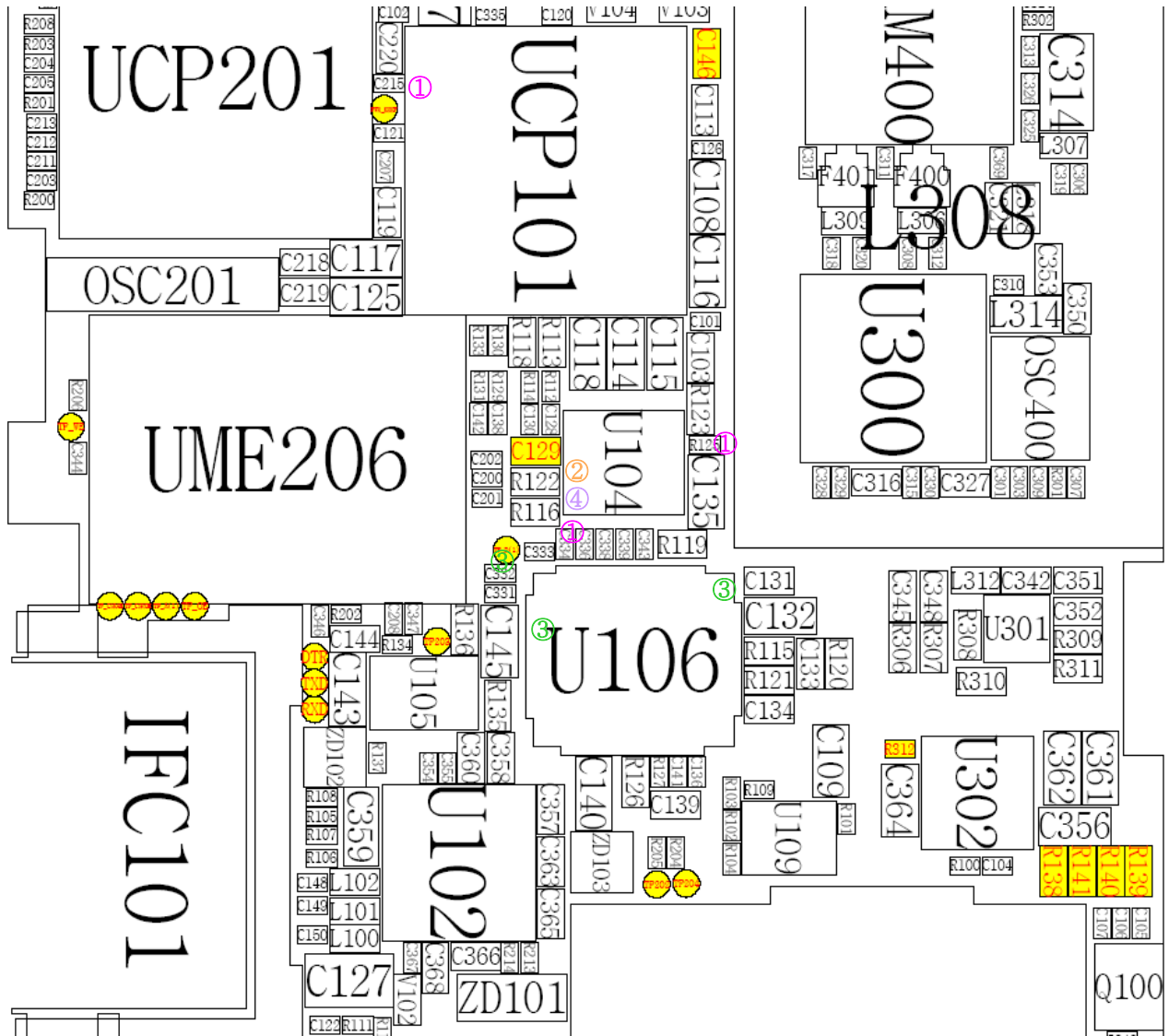

**3-2.RF**  
**3-2-1. EGSM Rx**

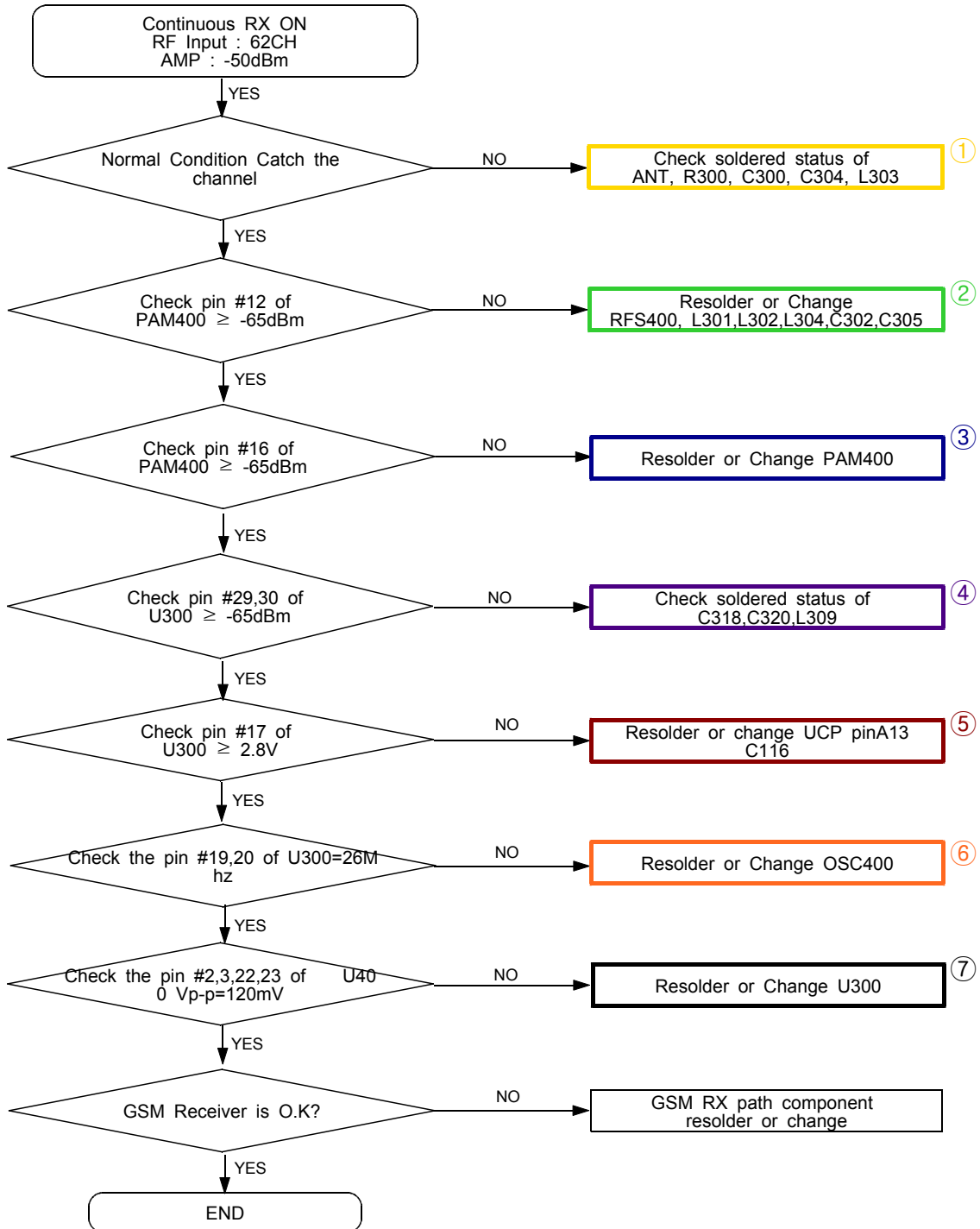

3-2-2. DCS Rx

CONTINUOUS TX ON CONDITION  
 TX POWER DAC: 500 CODE  
 APPLIED  
 CH : 30  
 RBW : 100KHz  
 VBW : 100KHz  
 SPAN : 10MHz  
 REF LEV. : 10dBm  
 ATT. : 20dB

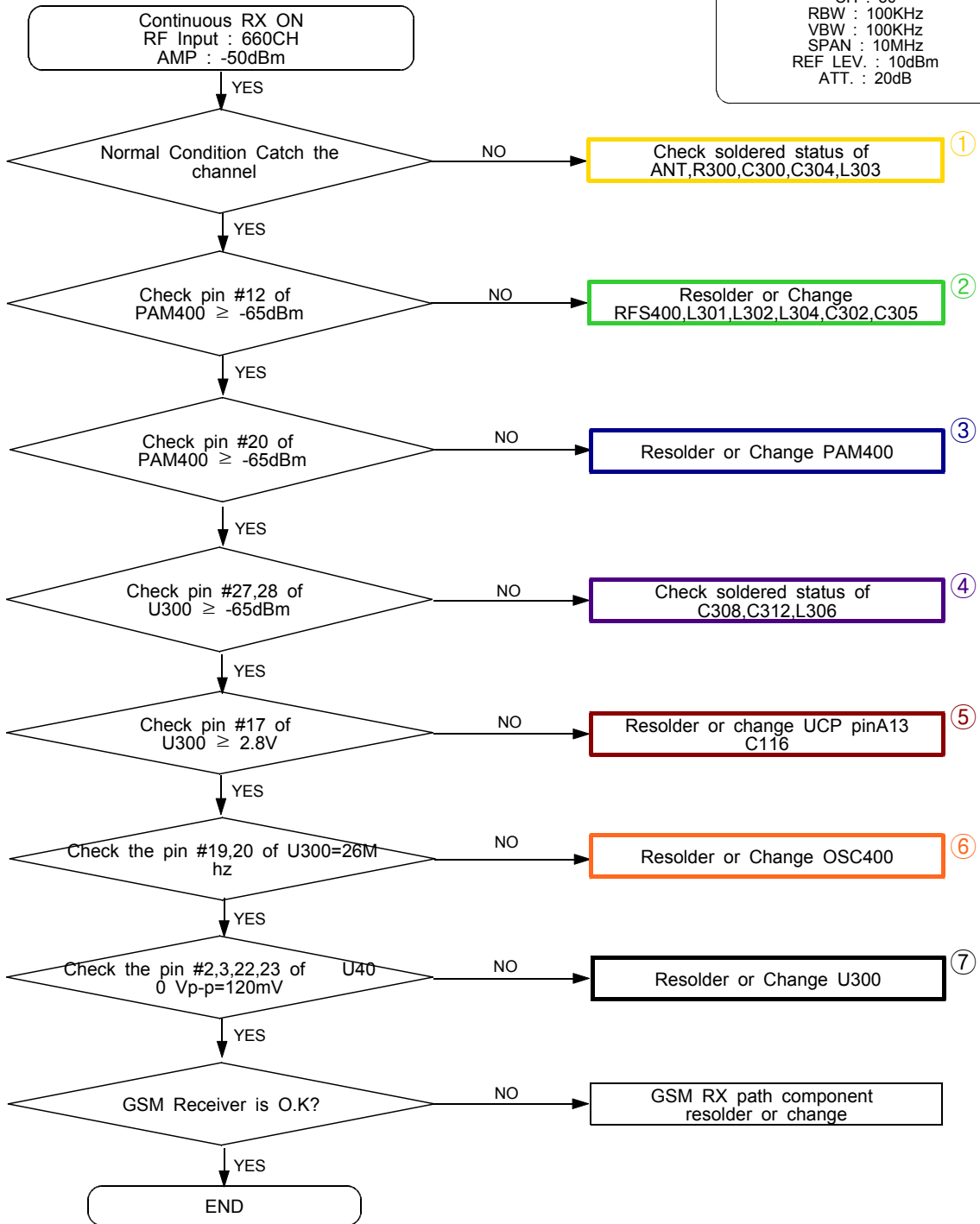





3-2-3. GSM Tx

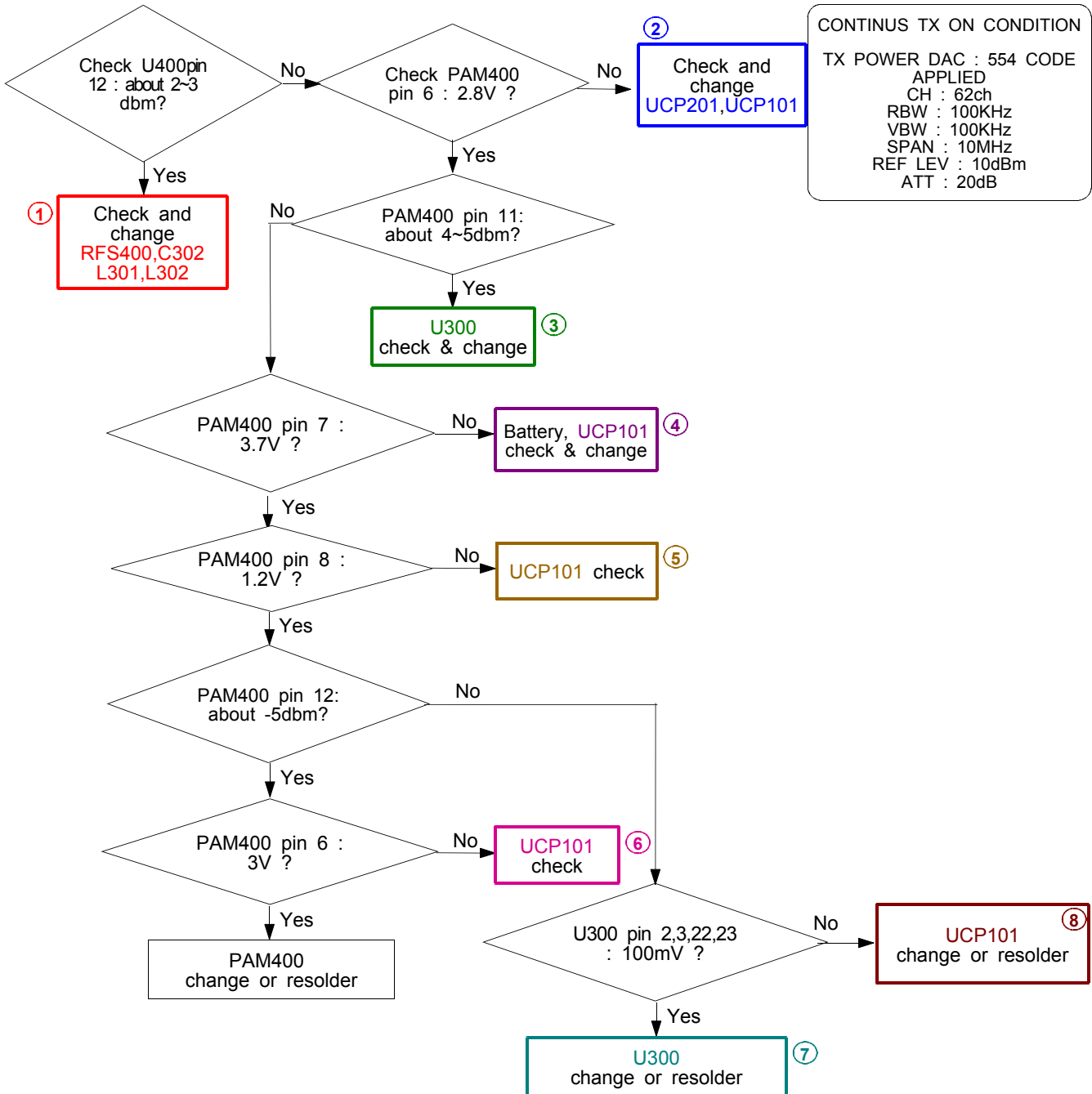

3-2-4. DCS Tx

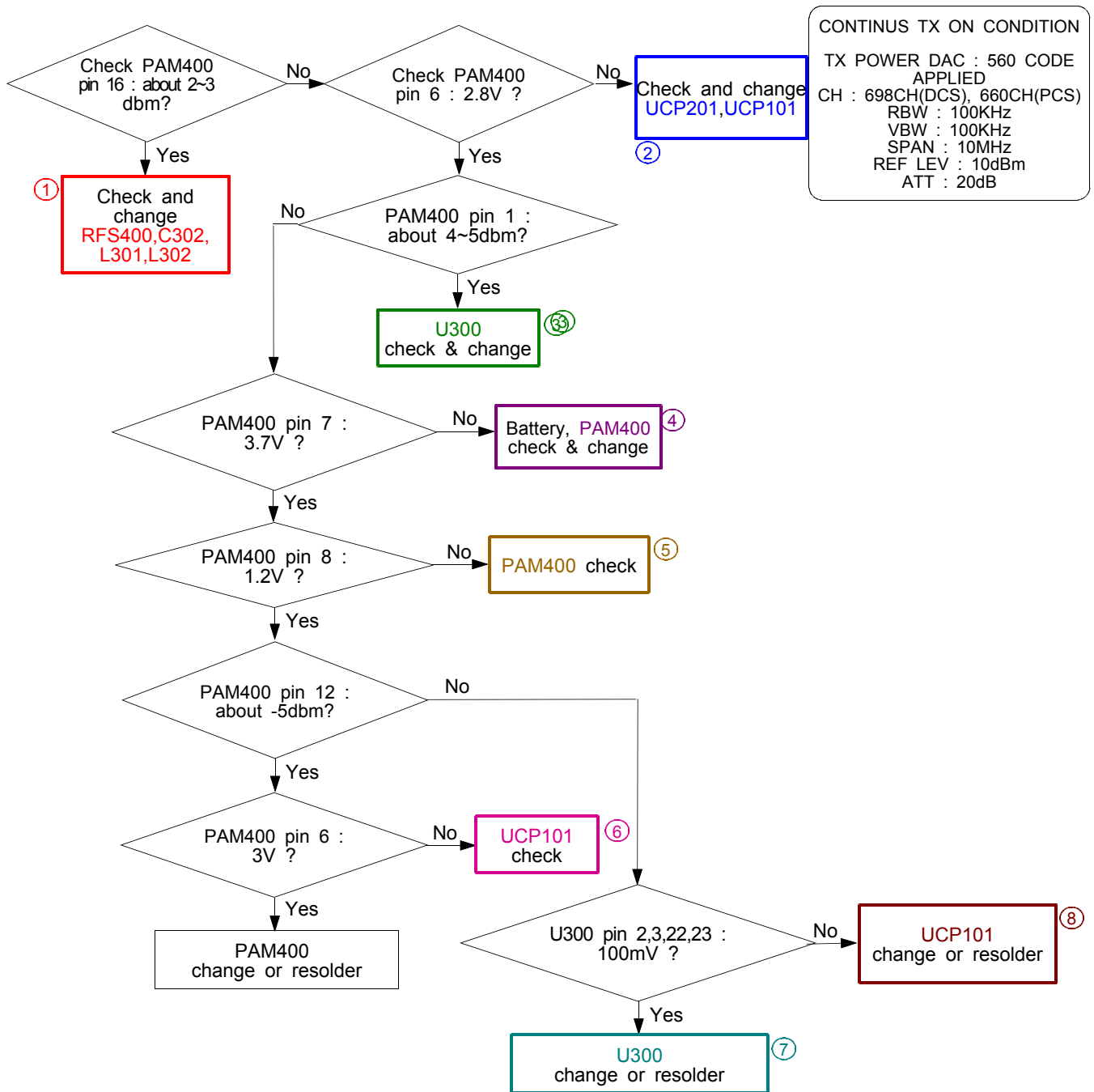

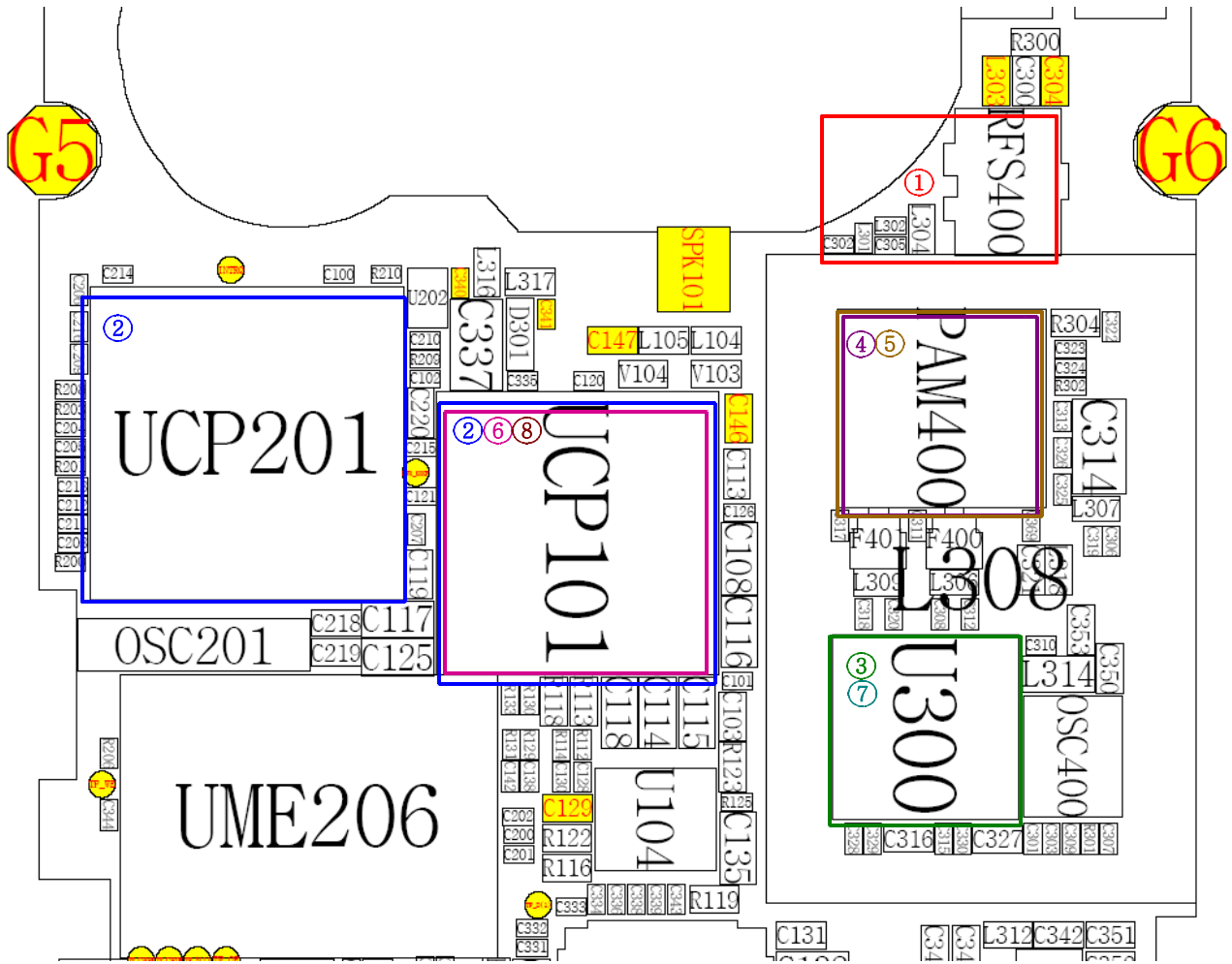

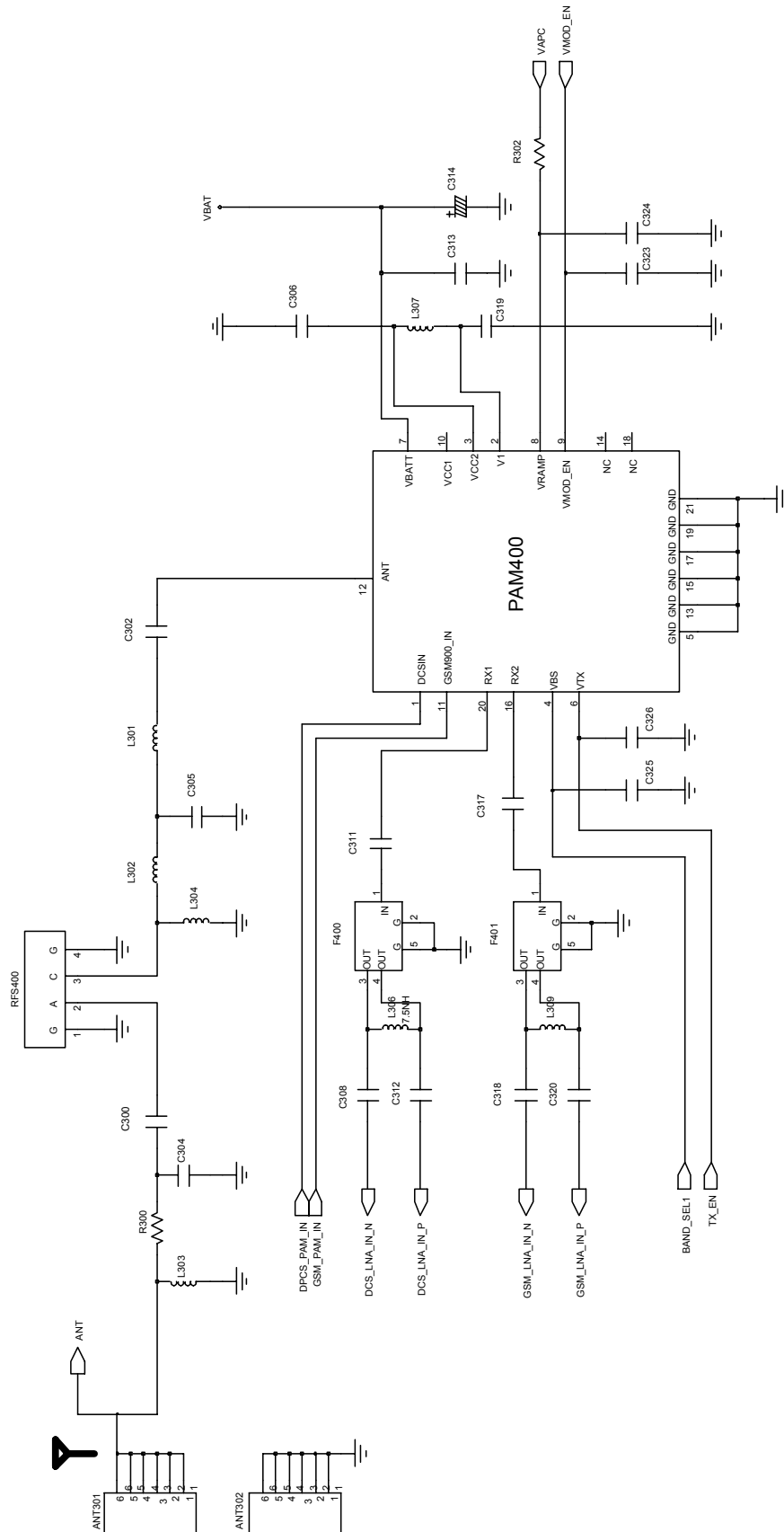

---

## 4. Array course control

---



**Test Jig (GH80-00865A)**



**Test Cable (GH39-00484A)**



**RF Test Cable (GH39-00397A)**

## **Software Downloading**

### **4-1. Downloading Binary Files**

- Three binary files for downloading C170.
  - C170XXYY.s3 : Main source code binary.

### **4-2. Pre-requisite for Downloading**

- Downloader Program([OptiFlash.exe](#))
- C170 Mobile Phone
- Data Cable
- Binary files



3. Select the **COM port** when the download cable is connected

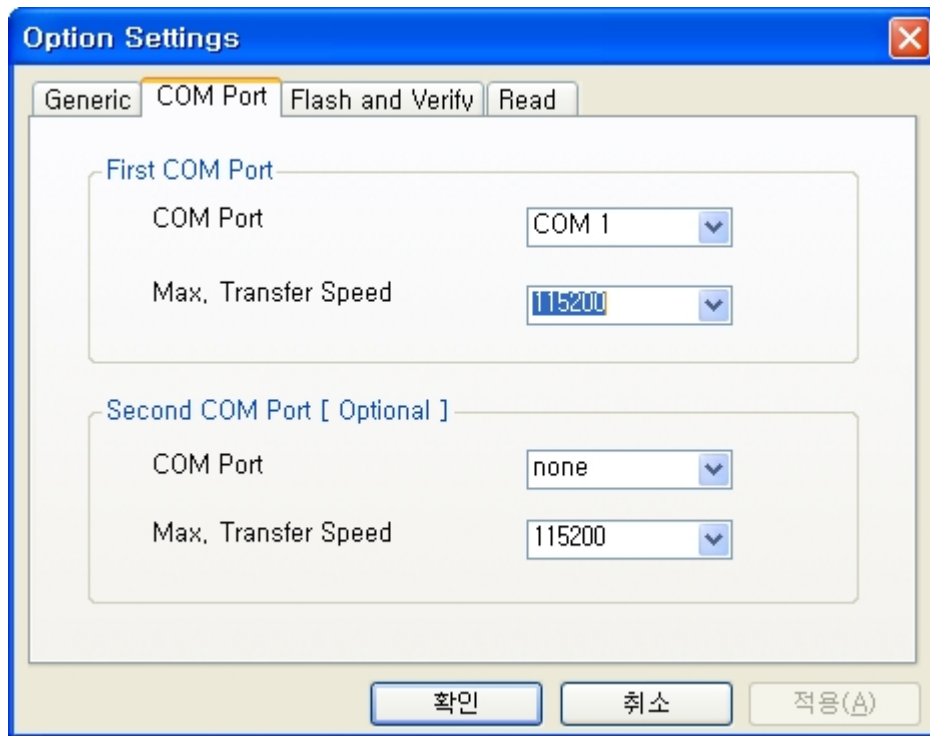

Up to twelve ports are supported. Additionally you can select the maximum transfer speed OptiFlash will use to communicate with the phone. However, OptiFlash will use a slower speed if either the PC's or the phone's serial hardware is incapable of handling the selected speed



#### 4. Select the “Flash&Verify” -> “Browse”

Set the directory path and choose the latest s/w binary, for example “C170XXYY.s3”, for the downloader binary setting.

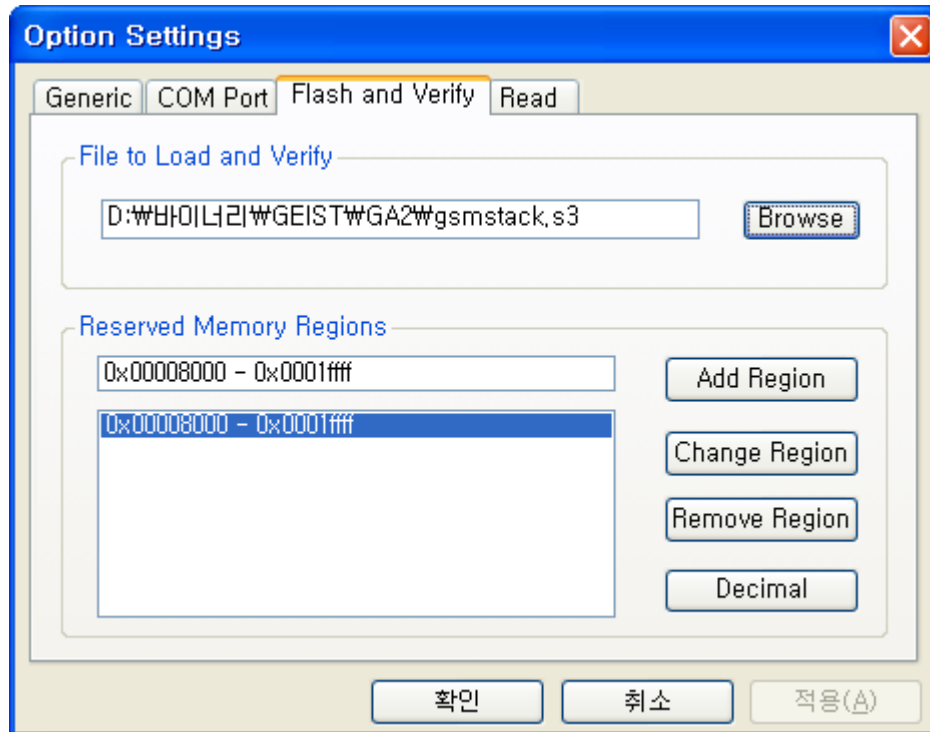

**Make sure that not to change the reserved memory regions.**

**In case of C140 the reserved memory regions are :  
-0x00008000 - 0x0001ffff**



# 5. Block Diagrams

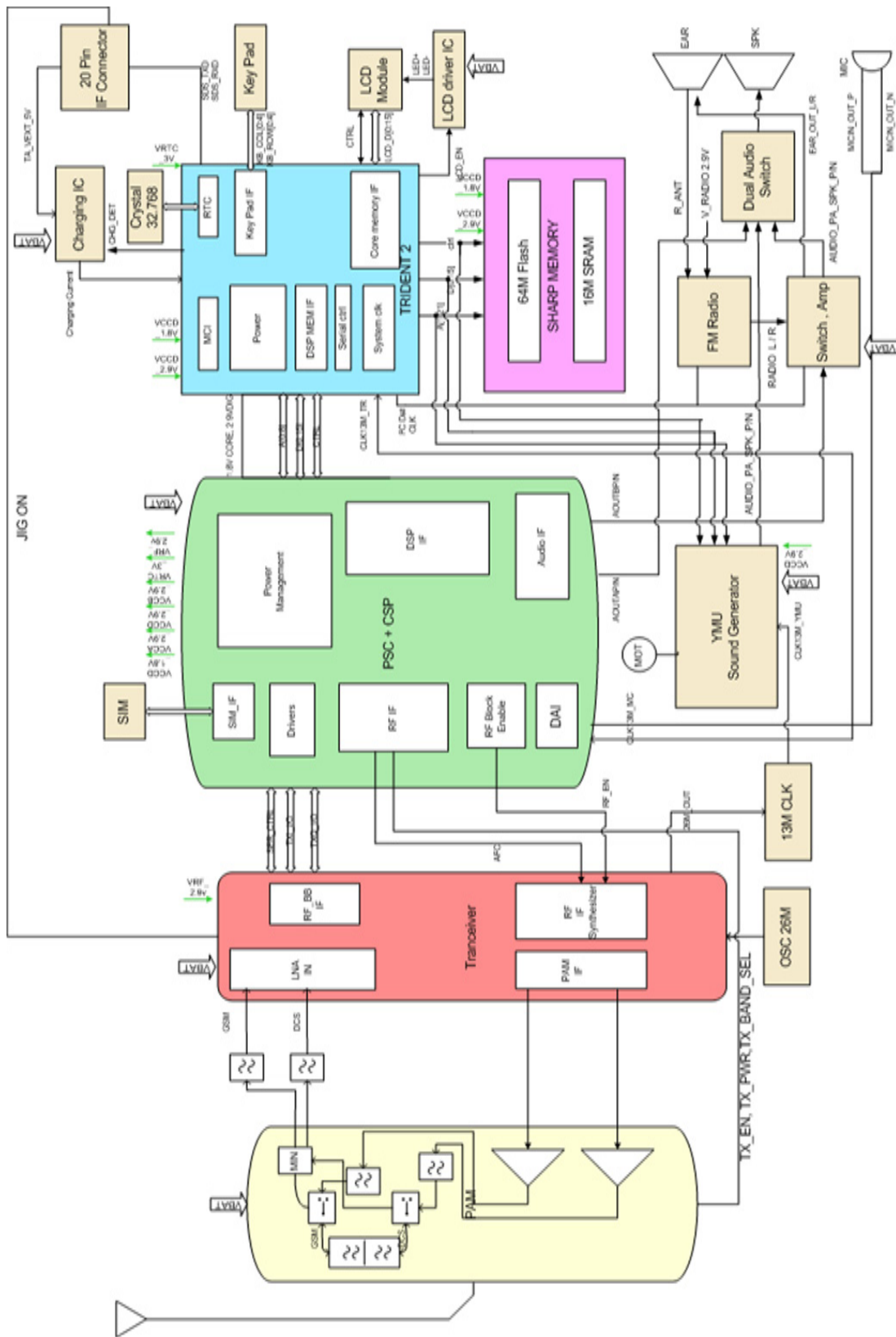

## 6. PCB Diagrams

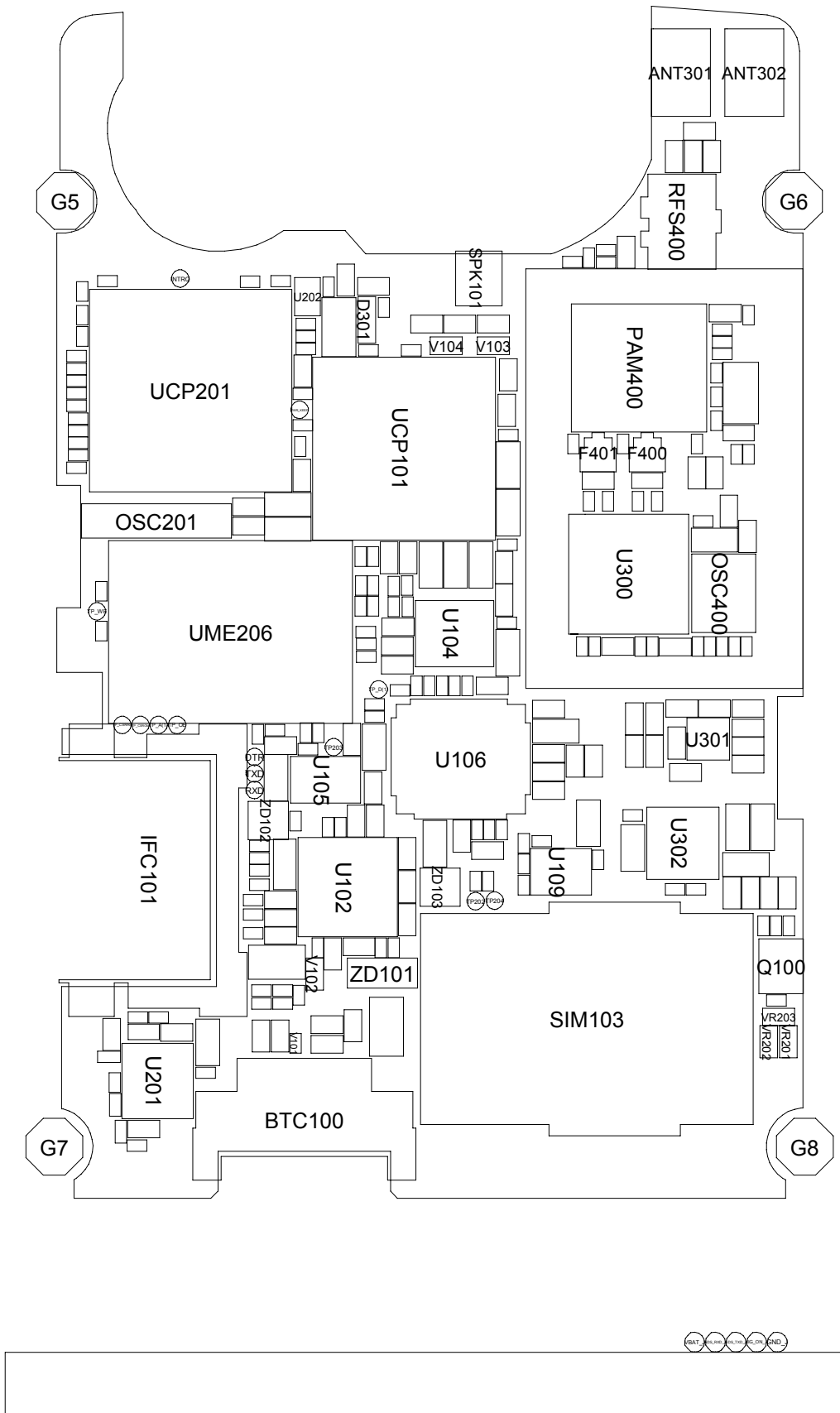

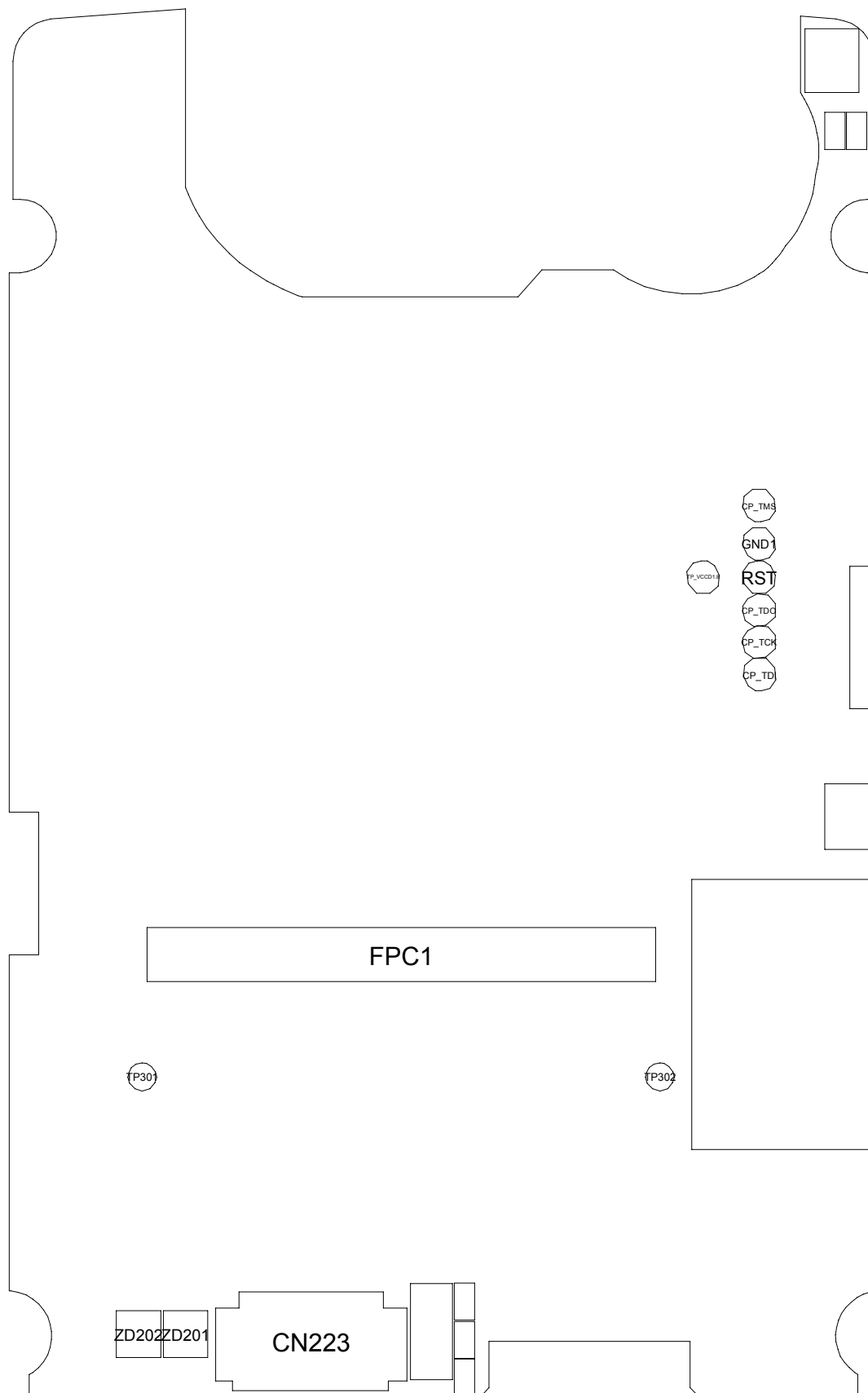

## 7. MAIN Electrical Parts List

SEC CODE	Design LOC	Discription	STATUS
0401-001141	D301	DIODE-SWITCHING	SA
0403-001547	ZD101	DIODE-ZENER	SA
0406-001241	ZD102	DIODE-TVS	SA
0406-001241	ZD103	DIODE-TVS	SA
0406-001241	ZD201	DIODE-TVS	SA
0406-001241	ZD202	DIODE-TVS	SA
0504-000168	Q100	TR-DIGITAL	SA
0801-002529	U109	IC-CMOS LOGIC	SA
0801-003013	U301	IC-CMOS LOGIC	SA
1001-001371	U104	IC-ANALOG SWITCH	SA
1108-000095	UME206	IC-MCP	SA
1201-002356	U102	IC-AUDIO AMP	SA
1201-002364	PAM400	IC-POWER AMP	SA
1203-003663	U105	IC-BATTERY	SA
1203-003897	UCP101	IC-POWER SUPERVISOR	SA
1203-004051	U302	IC-DC/DC CONVERTER	SA
1204-001811	U106	IC-MELODY	SA
1204-002688	U201	IC-DEMODULATOR	SA
1205-003098	U300	IC-TRANSCEIVER	SA
1209-001712	U202	IC-SENSOR	SA
1405-001082	V102	VARISTOR	SA
1405-001082	V103	VARISTOR	SA
1405-001082	V104	VARISTOR	SA
1405-001082	VR201	VARISTOR	SA
1405-001082	VR202	VARISTOR	SA
1405-001082	VR203	VARISTOR	SA
1405-001177	V101	VARISTOR	SA
2007-000139	R124	R-CHIP	SA
2007-000161	R113	R-CHIP	SA
2007-000161	R118	R-CHIP	SA
2007-000164	R115	R-CHIP	SA
2007-000170	R210	R-CHIP	SA
2007-000170	R309	R-CHIP	SA
2007-000170	R311	R-CHIP	SA
2007-000171	R116	R-CHIP	SA
2007-000171	R119	R-CHIP	SA

SEC CODE	Design LOC	Discription	STATUS
2007-000171	R300	R-CHIP	SA
2007-000242	R128	R-CHIP	SA
2007-000242	R132	R-CHIP	SA
2007-000775	R120	R-CHIP	SA
2007-000775	R121	R-CHIP	SA
2007-000775	R126	R-CHIP	SA
2007-001307	R310	R-CHIP	SA
2007-001308	R307	R-CHIP	SA
2007-002797	R306	R-CHIP	SA
2007-002965	R304	R-CHIP	SA
2007-007741	R301	R-CHIP	SA
2007-008051	R127	R-CHIP	SA
2007-008051	R216	R-CHIP	SA
2007-008052	R213	R-CHIP	SA
2007-008052	R214	R-CHIP	SA
2007-008055	R102	R-CHIP	SA
2007-008055	R103	R-CHIP	SA
2007-008055	R130	R-CHIP	SA
2007-008055	R133	R-CHIP	SA
2007-008055	R134	R-CHIP	SA
2007-008055	R203	R-CHIP	SA
2007-008055	R208	R-CHIP	SA
2007-008055	R209	R-CHIP	SA
2007-008403	R207	R-CHIP	SA
2007-008403	R211	R-CHIP	SA
2007-008419	R107	R-CHIP	SA
2007-008419	R108	R-CHIP	SA
2007-008419	R137	R-CHIP	SA
2007-008478	R111	R-CHIP	SA
2007-008478	R117	R-CHIP	SA
2007-008483	R105	R-CHIP	SA
2007-008483	R125	R-CHIP	SA
2007-008483	R206	R-CHIP	SA
2007-008486	R204	R-CHIP	SA
2007-008486	R205	R-CHIP	SA
2007-008516	R112	R-CHIP	SA

SEC CODE	Design LOC	Discription	STATUS
2007-008516	R114	R-CHIP	SA
2007-008516	R129	R-CHIP	SA
2007-008516	R131	R-CHIP	SA
2007-008516	R302	R-CHIP	SA
2007-008531	R200	R-CHIP	SA
2007-008531	R202	R-CHIP	SA
2007-008579	R110	R-CHIP	SA
2007-008786	R215	R-CHIP	SA
2007-009154	R212	R-CHIP	SNA
2007-009160	R135	R-CHIP	SA
2007-009170	R106	R-CHIP	SA
2007-009315	R100	R-CHIP	SA
2007-009315	R201	R-CHIP	SA
2203-000233	C220	C-CER,CHIP	SA
2203-000233	C224	C-CER,CHIP	SA
2203-000386	C218	C-CER,CHIP	SA
2203-000386	C219	C-CER,CHIP	SA
2203-000386	C345	C-CER,CHIP	SA
2203-000438	C139	C-CER,CHIP	SA
2203-000438	C350	C-CER,CHIP	SA
2203-000438	C363	C-CER,CHIP	SA
2203-000438	C365	C-CER,CHIP	SA
2203-000466	C321	C-CER,CHIP	SA
2203-000627	C353	C-CER,CHIP	SNA
2203-000654	C133	C-CER,CHIP	SA
2203-000812	C344	C-CER,CHIP	SA
2203-000812	C351	C-CER,CHIP	SA
2203-001405	C134	C-CER,CHIP	SA
2203-001412	C348	C-CER,CHIP	SA
2203-002709	C111	C-CER,CHIP	SA
2203-002709	C113	C-CER,CHIP	SA
2203-002709	C119	C-CER,CHIP	SA
2203-005482	C342	C-CER,CHIP	SA
2203-005482	C352	C-CER,CHIP	SA
2203-005682	C105	C-CER,CHIP	SA
2203-005682	C106	C-CER,CHIP	SA



SEC CODE	Design LOC	Discription	STATUS
2203-005682	C323	C-CER,CHIP	SA
2203-005682	C325	C-CER,CHIP	SA
2203-005682	C326	C-CER,CHIP	SA
2203-005682	C331	C-CER,CHIP	SA
2203-005682	C332	C-CER,CHIP	SA
2203-005682	C333	C-CER,CHIP	SA
2203-005682	C334	C-CER,CHIP	SA
2203-005682	C336	C-CER,CHIP	SA
2203-005682	C338	C-CER,CHIP	SA
2203-005682	C339	C-CER,CHIP	SA
2203-005682	C343	C-CER,CHIP	SA
2203-005682	C346	C-CER,CHIP	SA
2203-005682	C347	C-CER,CHIP	SA
2203-005682	C349	C-CER,CHIP	SA
2203-005683	C308	C-CER,CHIP	SA
2203-005683	C312	C-CER,CHIP	SA
2203-005717	C204	C-CER,CHIP	SA
2203-005717	C226	C-CER,CHIP	SA
2203-005719	C301	C-CER,CHIP	SA
2203-005719	C307	C-CER,CHIP	SA
2203-005719	C310	C-CER,CHIP	SA
2203-005719	C318	C-CER,CHIP	SA
2203-005719	C320	C-CER,CHIP	SA
2203-005729	C149	C-CER,CHIP	SA
2203-005736	C208	C-CER,CHIP	SA
2203-005736	C311	C-CER,CHIP	SA
2203-005736	C317	C-CER,CHIP	SA
2203-005736	C324	C-CER,CHIP	SA
2203-005777	C369	C-CER,CHIP	SA
2203-005819	C109	C-CER,CHIP	SA
2203-005819	C125	C-CER,CHIP	SA
2203-005819	C356	C-CER,CHIP	SA
2203-005819	C361	C-CER,CHIP	SA
2203-005819	C362	C-CER,CHIP	SA
2203-005819	C364	C-CER,CHIP	SA
2203-006048	C131	C-CER,CHIP	SA

SEC CODE	Design LOC	Discription	STATUS
2203-006048	C217	C-CER,CHIP	SA
2203-006194	C101	C-CER,CHIP	SA
2203-006194	C203	C-CER,CHIP	SA
2203-006194	C205	C-CER,CHIP	SA
2203-006194	C209	C-CER,CHIP	SA
2203-006194	C210	C-CER,CHIP	SA
2203-006194	C212	C-CER,CHIP	SA
2203-006194	C213	C-CER,CHIP	SA
2203-006194	C306	C-CER,CHIP	SA
2203-006194	C309	C-CER,CHIP	SA
2203-006194	C315	C-CER,CHIP	SA
2203-006257	C104	C-CER,CHIP	SA
2203-006257	C223	C-CER,CHIP	SA
2203-006257	C357	C-CER,CHIP	SA
2203-006257	C358	C-CER,CHIP	SA
2203-006260	C327	C-CER,CHIP	SA
2203-006260	C366	C-CER,CHIP	SA
2203-006260	C368	C-CER,CHIP	SA
2203-006318	C305	C-CER,CHIP	SA
2203-006324	C108	C-CER,CHIP	SA
2203-006324	C135	C-CER,CHIP	SA
2203-006348	C114	C-CER,CHIP	SA
2203-006348	C115	C-CER,CHIP	SA
2203-006348	C116	C-CER,CHIP	SA
2203-006348	C117	C-CER,CHIP	SA
2203-006423	C102	C-CER,CHIP	SA
2203-006423	C126	C-CER,CHIP	SA
2203-006423	C128	C-CER,CHIP	SA
2203-006423	C130	C-CER,CHIP	SA
2203-006423	C136	C-CER,CHIP	SA
2203-006423	C138	C-CER,CHIP	SA
2203-006423	C141	C-CER,CHIP	SA
2203-006423	C142	C-CER,CHIP	SA
2203-006423	C200	C-CER,CHIP	SA
2203-006423	C201	C-CER,CHIP	SA
2203-006423	C202	C-CER,CHIP	SA

SEC CODE	Design LOC	Discription	STATUS
2203-006423	C206	C-CER,CHIP	SA
2203-006423	C211	C-CER,CHIP	SA
2203-006423	C215	C-CER,CHIP	SA
2203-006423	C216	C-CER,CHIP	SA
2203-006423	C227	C-CER,CHIP	SA
2203-006423	C303	C-CER,CHIP	SA
2203-006423	C313	C-CER,CHIP	SA
2203-006423	C319	C-CER,CHIP	SA
2203-006423	C328	C-CER,CHIP	SA
2203-006423	C329	C-CER,CHIP	SA
2203-006423	C330	C-CER,CHIP	SA
2203-006423	C335	C-CER,CHIP	SA
2203-006423	C367	C-CER,CHIP	SA
2203-006556	C107	C-CER,CHIP	SA
2203-006556	C225	C-CER,CHIP	SA
2203-006556	C302	C-CER,CHIP	SA
2203-006556	C322	C-CER,CHIP	SA
2203-006562	C124	C-CER,CHIP	SA
2203-006562	C221	C-CER,CHIP	SA
2203-006620	C122	C-CER,CHIP	SNA
2203-006620	C123	C-CER,CHIP	SNA
2203-006626	C316	C-CER,CHIP	SA
2203-006648	C121	C-CER,CHIP	SA
2203-006648	C207	C-CER,CHIP	SA
2203-006648	C354	C-CER,CHIP	SA
2203-006648	C355	C-CER,CHIP	SA
2203-006681	C144	C-CER,CHIP	SA
2203-006824	C132	C-CER,CHIP	SA
2203-006824	C140	C-CER,CHIP	SA
2203-006824	C145	C-CER,CHIP	SA
2203-006838	C360	C-CER,CHIP	SA
2203-006896	C148	C-CER,CHIP	SA
2203-006896	C150	C-CER,CHIP	SA
2404-001374	C314	C-TA,CHIP	SA
2404-001381	C359	C-TA,CHIP	SA
2404-001430	C337	C-TA,CHIP	SA

SEC CODE	Design LOC	Discription	STATUS
2703-001231	L103	INDUCTOR-SMD	SNA
2703-001747	L318	INDUCTOR-SMD	SA
2703-002200	L309	INDUCTOR-SMD	SA
2703-002206	L310	INDUCTOR-SMD	SA
2703-002206	L313	INDUCTOR-SMD	SA
2703-002206	L316	INDUCTOR-SMD	SA
2703-002206	L317	INDUCTOR-SMD	SA
2703-002313	L304	INDUCTOR-SMD	SA
2703-002484	L306	INDUCTOR-SMD	SA
2703-002558	L307	INDUCTOR-SMD	SA
2703-002910	L200	INDUCTOR-SMD	SA
2703-002917	L301	INDUCTOR-SMD	SA
2703-002917	L302	INDUCTOR-SMD	SA
2703-002989	L201	INDUCTOR-SMD	SA
2801-003856	OSC201	CRYSTAL-SMD	SA
2801-004587	OSC400	CRYSTAL-SMD	SA
2904-001592	F401	FILTER-SAW	SA
2904-001599	F400	FILTER-SAW	SA
3301-001534	L312	BEAD-SMD	SA
3301-001729	L100	BEAD-SMD	SA
3301-001729	L101	BEAD-SMD	SA
3301-001729	L102	BEAD-SMD	SA
3705-001358	RFS400	CONNECTOR-COAXIAL	SA
3708-002222	CN223	CONNECTOR-FPC/FFC/PIC	SA
3709-001391	SIM103	CONNECTOR-CARD EDGE	SA
3711-006217	BTC100	HEADER-BATTERY	SA
GH09-00039A	UCP201	IC MICOM	SA
GH71-06419A	ANT301	NPR-ANTENNA CONTACT	SA
GH71-06419A	ANT302	NPR-ANTENNA CONTACT	SA
2007-000140	R109	R-CHIP	SA
2007-000155	R136	R-CHIP	SA
2007-000172	R101	R-CHIP	SA
2007-001288	R122	R-CHIP	SA
2007-001288	R123	R-CHIP	SA
2007-001339	R104	R-CHIP	SA
2203-000254	C100	C-CER,CHIP	SA

---

SEC CODE	Design LOC	Discription	STATUS
2203-000254	C214	C-CER,CHIP	SA
2203-000940	C103	C-CER,CHIP	SA
2203-000995	C129	C-CER,CHIP	SA
2203-002668	C304	C-CER,CHIP	SA
2203-005450	C300	C-CER,CHIP	SA
2203-005481	C222	C-CER,CHIP	SA
2203-006137	C120	C-CER,CHIP	SA
2203-006708	C118	C-CER,CHIP	SA
2203-006885	C143	C-CER,CHIP	SA
2404-001496	C110	C-TA,CHIP	SA
2404-001496	C127	C-TA,CHIP	SA
2404-001496	C137	C-TA,CHIP	SA
2703-001236	L314	INDUCTOR-SMD	SA
3710-002477	IFC101	SOCKET-INTERFACE	SA
GH70-02200A	L308	IPR-BRACKET FRAME	SA
2703-001180	L104	INDUCTOR-SMD	SA
2703-001180	L105	INDUCTOR-SMD	SA
2203-006399	C146	C-CER,CHIP	SA
2203-006399	C147	C-CER,CHIP	SA

---

## 8. Reference data

---

### 8-1. Reference Abbreviate

**AAC:** Advanced Audio Coding.

**AVC :** Advanced Video Coding.

**BER :** Bit Error Rate

**BPSK:** Binary Phase Shift Keying

**CA :** Conditional Access

**CDM :** Code Division Multiplexing

**C/I :** Carrier to Interference

**DMB :** Digital Multimedia Broadcasting

**EN :** European Standard

**ES :** Elementary Stream

**ETSI:** European Telecommunications Standards Institute

**MPEG:** Moving Picture Experts Group

**PN :** Pseudo-random Noise

**PS :** Pilot Symbol

**QPSK:** Quadrature Phase Shift Keying

**RS :** Reed-Solomon

**SI :** Service Information

**TDM :** Time Division Multiplexing

**TS :** Transport Stream

---

## 9. Safety Precautions

---

### 9-1. Repair Precaution

- Repair in Shield Box, during detailed tuning.  
Take specially care of tuning or test,  
because specipcty of cellular phone is sensitive for surrounding interference(RF noise).
- Be careful to use a kind of magnetic object or tool,  
because performance of parts is damaged by the influence of manetic force.
- Surely use a standard screwdriver when you disassemble this product,  
otherwise screw will be worn away.
- Use a thicken twisted wire when you measure level.  
A thicken twisted wire has low resistance, therefore error of measurement is few.
- Repair after separate Test Pack and Set because for short danger (for example an  
overcurrent and furious flames of parts etc) when you repair board in condition of  
connecting Test Pack and tuning on.
- Take specially care of soldering, because Land of PCB is small and weak in heat.
- Surely tune on/off while using AC power plug, because a repair of battery charger is  
dangerous when tuning ON/OFF PBA and Connector after disassembling charger.
- Don't use as you pleases after change other material than replacement registered on SEC  
System.  
Otherwise engineer in charge isn't charged with problem that you don't keep this rules.

## 9-2. ESD(Electrostatically Sensitive Devices) Precaution

Several semiconductor may be damaged easily by static electricity. Such parts are called by ESD(Electrostatically Sensitive Devices), for example IC,BGA chip etc. Read Precaution below. You can prevent from ESD damage by static electricity.

- Remove static electricity remained your body before you touch semiconductor or parts with semiconductor. There are ways that you touch an earthed place or wear static electricity prevention string on wrist.
- Use earthed soldering steel when you connect or disconnect ESD.
- Use soldering removing tool to break static electricity. , otherwise ESD will be damaged by static electricity.
- Don't unpack until you set up ESD on product. Because most of ESD are packed by box and aluminum plate to have conductive power,they are prevented from static electricity.
- You must maintain electric contact between ESD and place due to be set up until ESD is connected completely to the proper place or a circuit board.



---

## 10. Product Function

---

### Main Function

- Speed dial
- SDN (Service Dialling Number)
- Network services
- Read SMS messages, SOS messages
- Voicemail
- Web browser
- Alarm, Calendar, Time and date, Calculator, Task list, Voice memo, FM Radio etc.

**SAMSUNG  
ELECTRONICS**



GSPN (Global Service Partner Network)

<b>Country</b>	<b>Web Site</b>
North America	<a href="http://service.samsungportal.com">service.samsungportal.com</a>
Latin America	<a href="http://latin.samsungportal.com">latin.samsungportal.com</a>
CIS	<a href="http://cis.samsungportal.com">cis.samsungportal.com</a>
Europe	<a href="http://europe.samsungportal.com">europe.samsungportal.com</a>
China	<a href="http://china.samsungportal.com">china.samsungportal.com</a>
Asia	<a href="http://asia.samsungportal.com">asia.samsungportal.com</a>
Mideast & Africa	<a href="http://mea.samsungportal.com">mea.samsungportal.com</a>